

sf 835

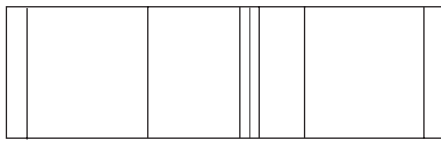

sf 508

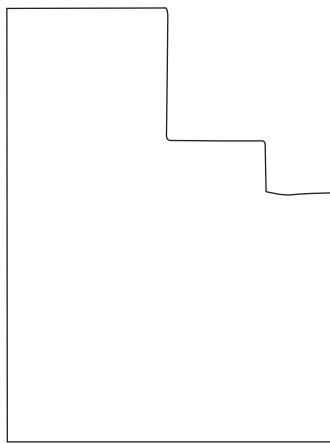

sf 858

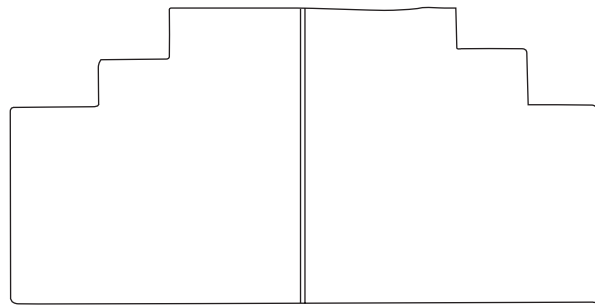

sf 678

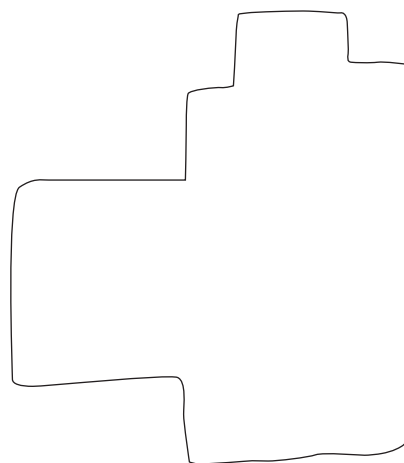

sf 882

0 250 mm

1:4

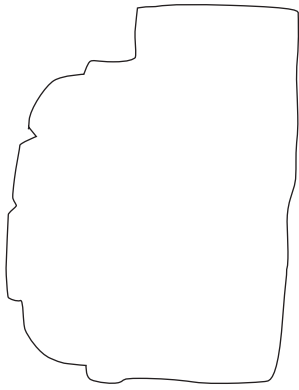

sf 505

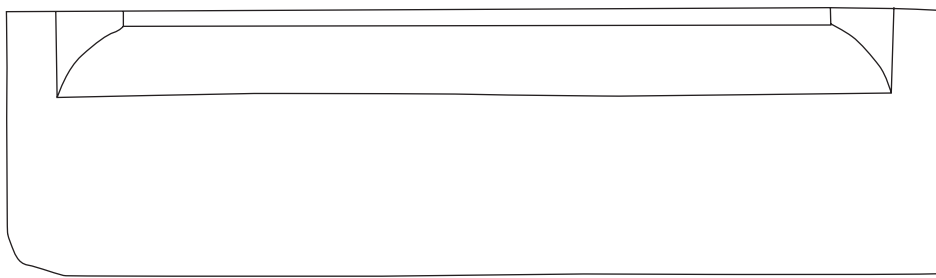

sf 507

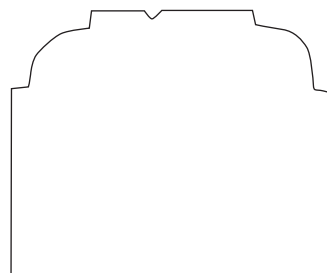

0 250 mm

1:4



sf 35



sf 776

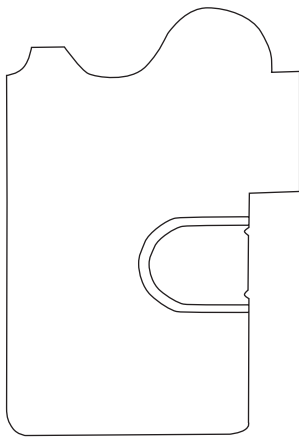

sf 779



1:4



sf 908



sf 881

0 250 mm

1:4

Mouldings



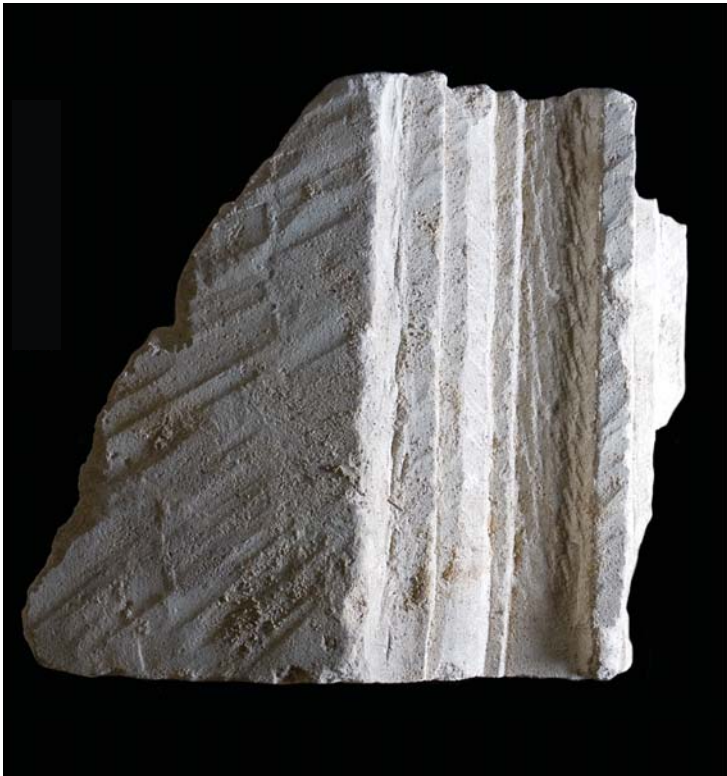
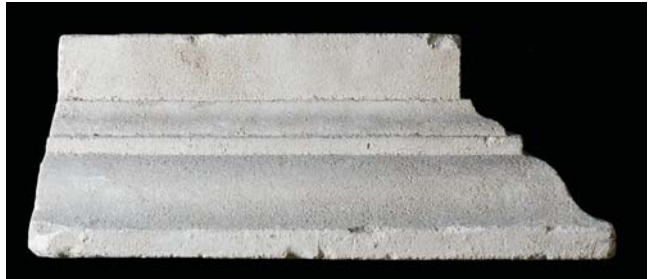
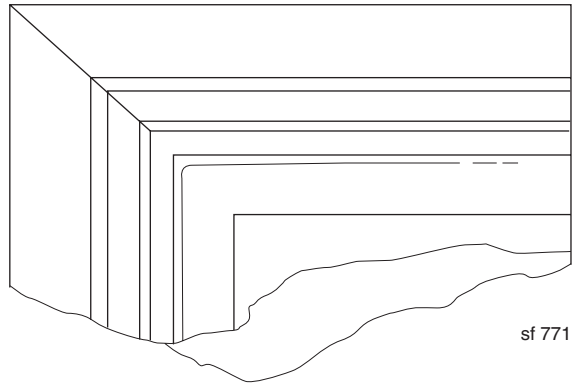

0 250 mm

1:4

Mouldings

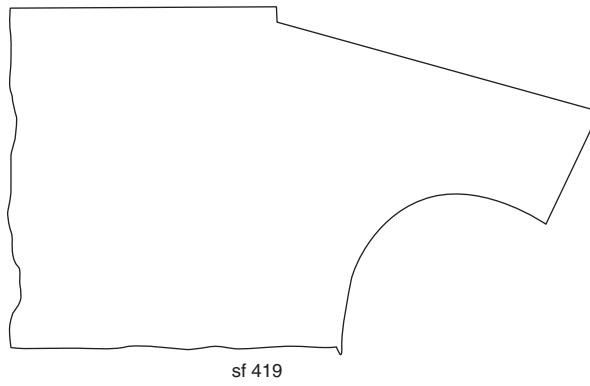
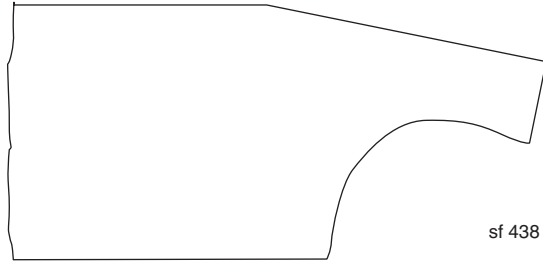
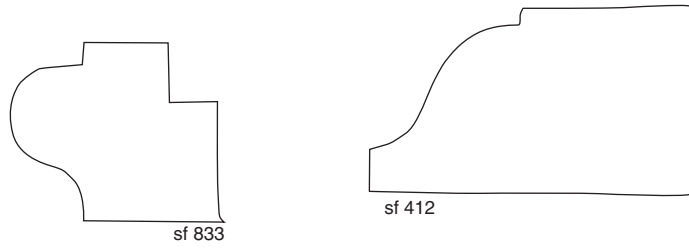

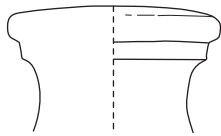

sf 940

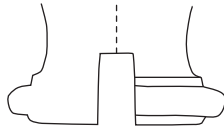

sf 941

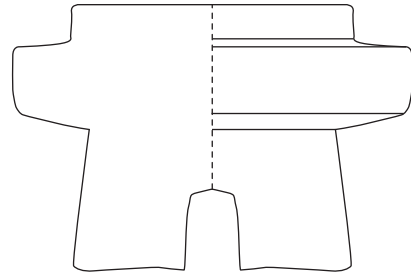

sf 965

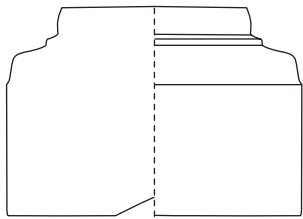

sf 709

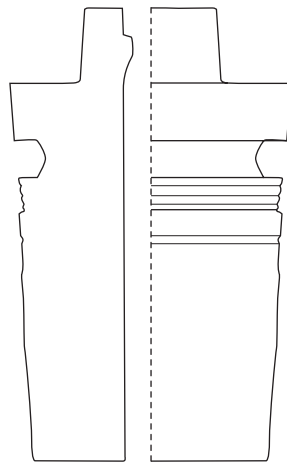

sf 720

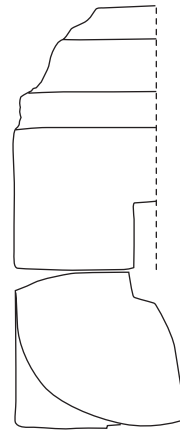

sf 706

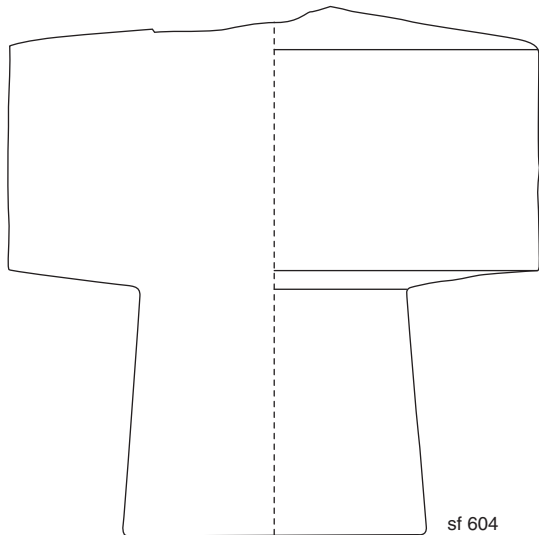

sf 604

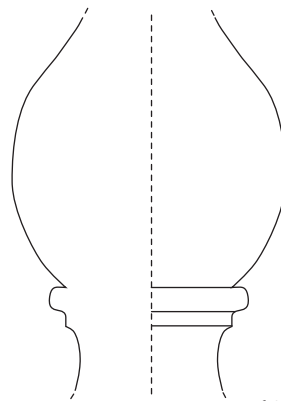

sf 696



1:4



0 250 mm  
1:4

Balusters



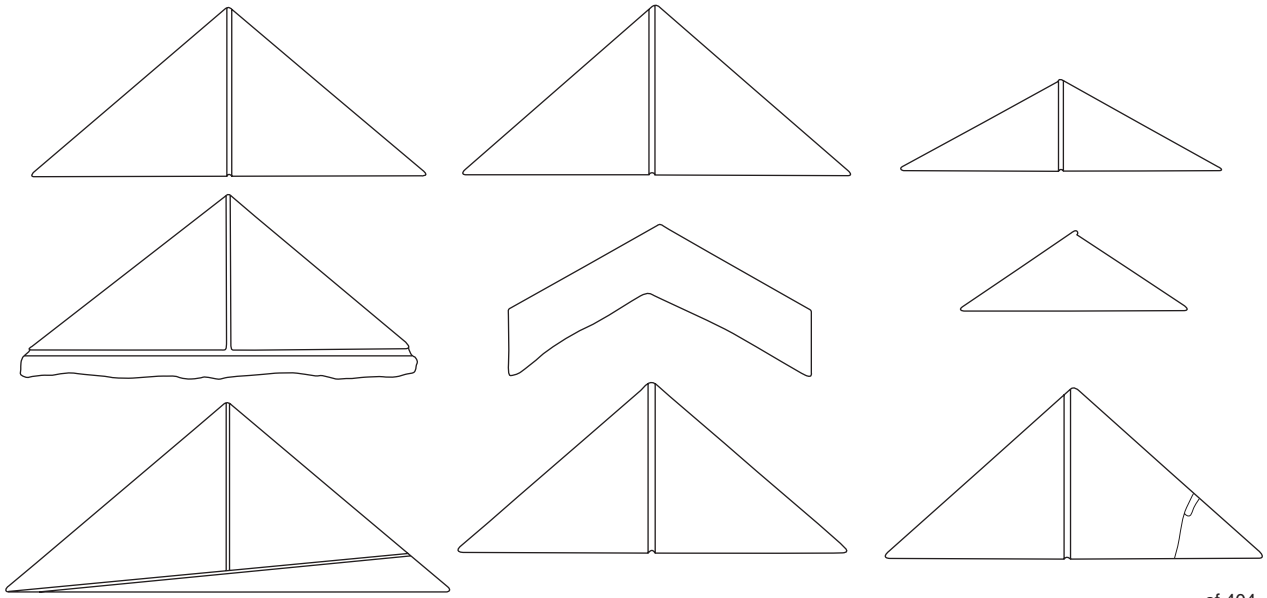

sf 404

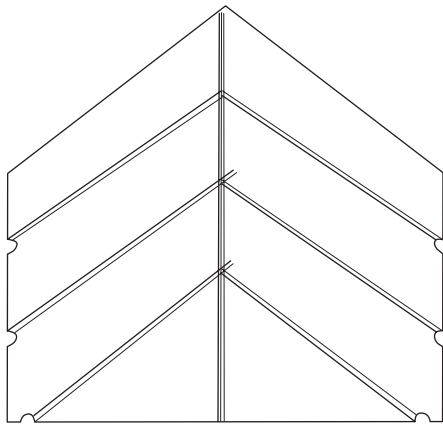

sf 272



sf 183

0 250 mm

1:4

Ridge stones

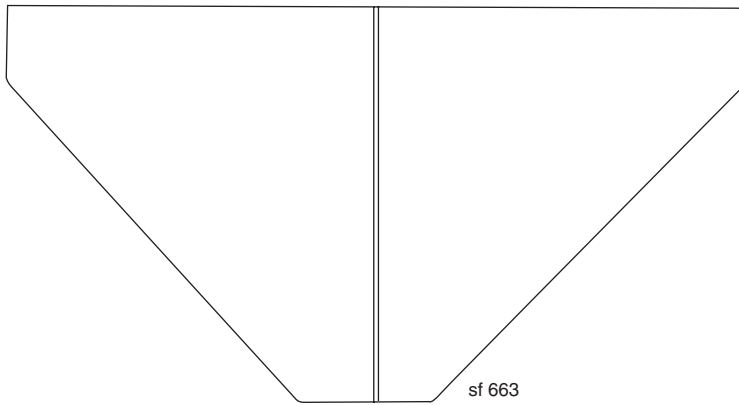

Silt traps

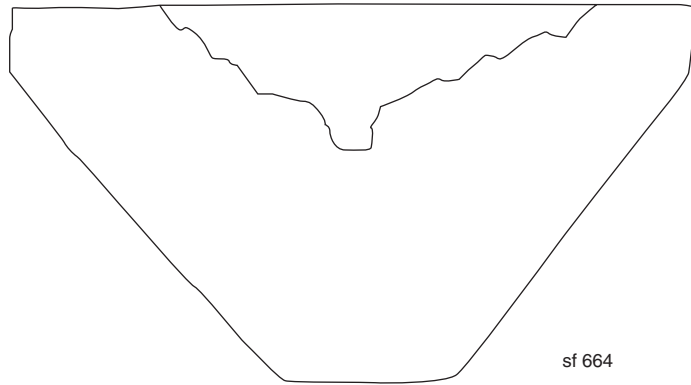

sf 664



1:4

Silt traps

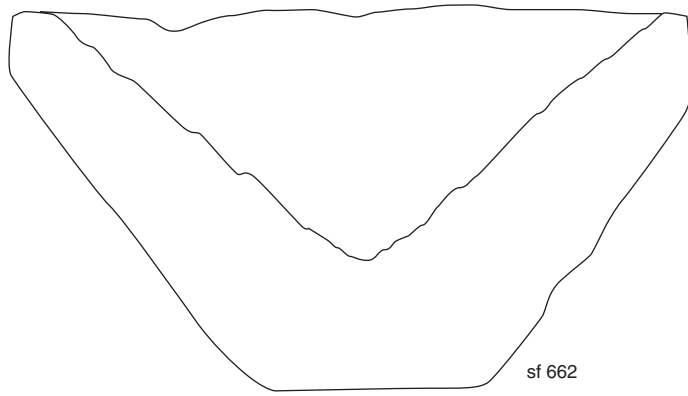

Silt traps



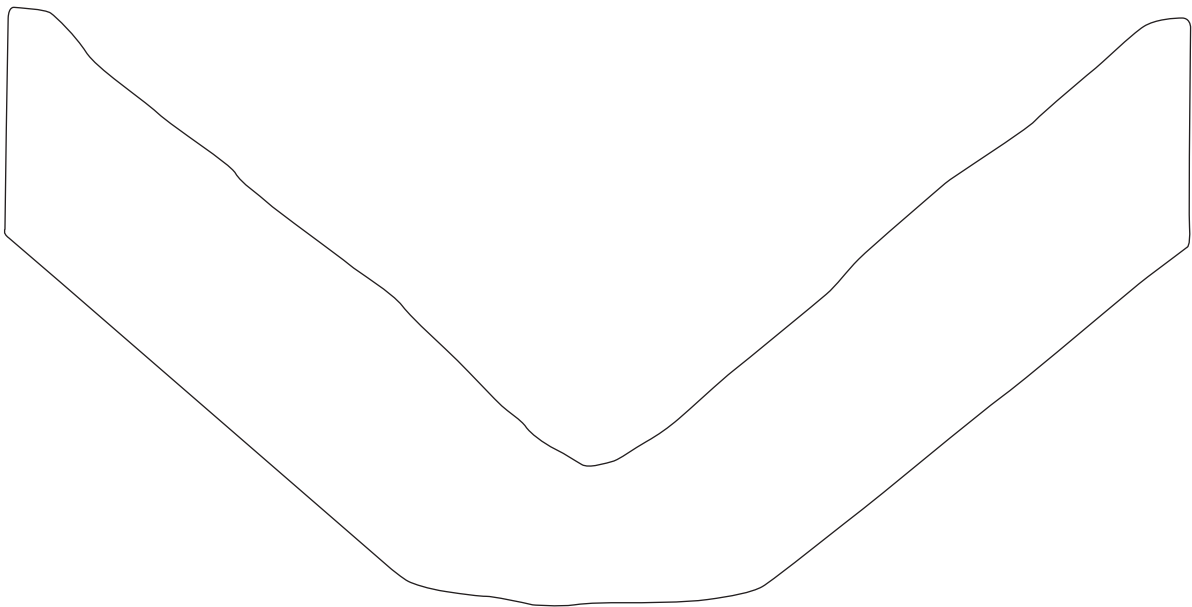

sf 671

0 250 mm

1:5

Silt traps





sf 563

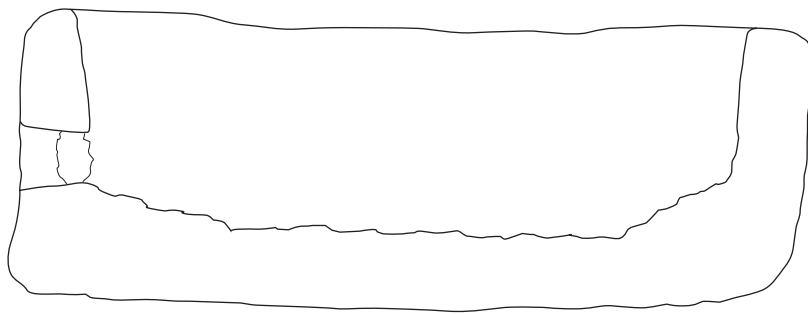

sf 606



1:4

Boxes

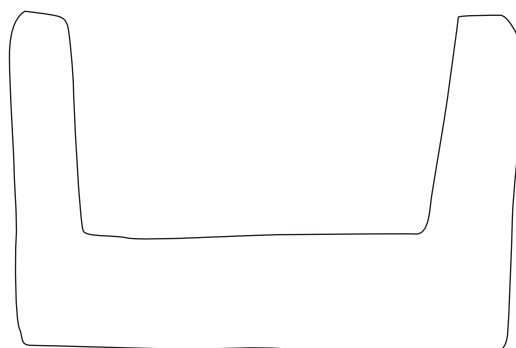
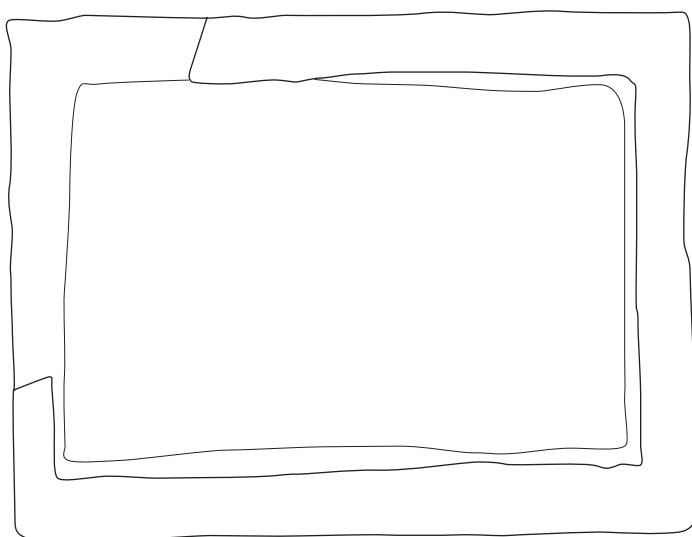

sf 501

0 250 mm

1:4

Boxes

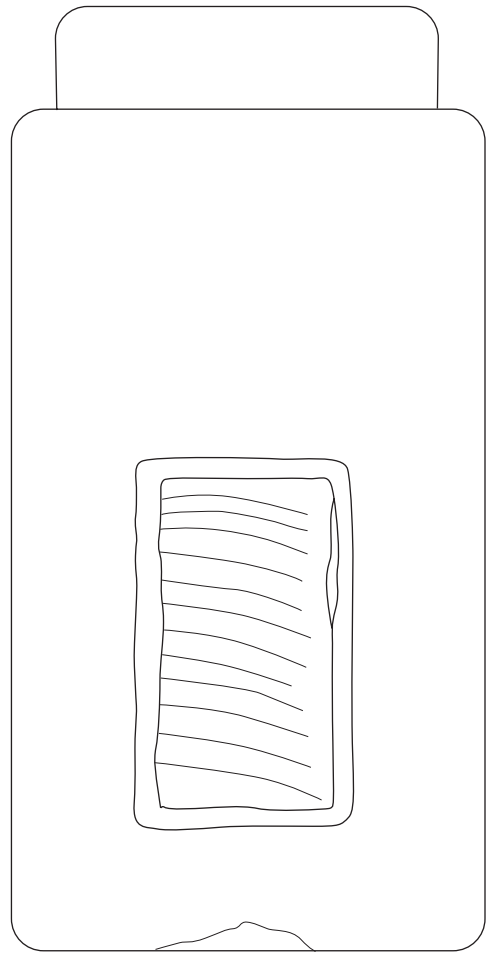
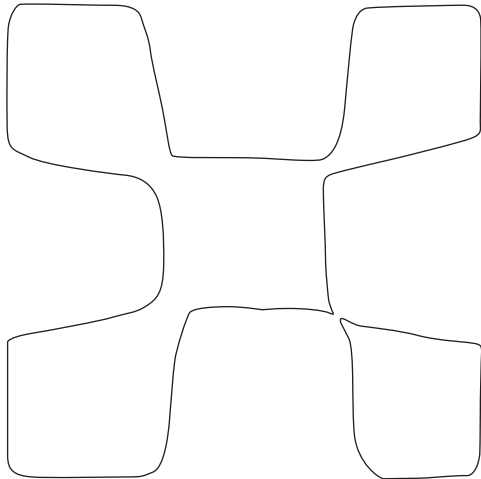

sf 611

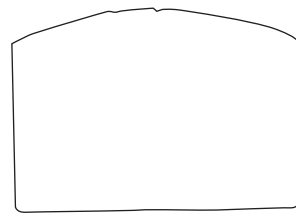
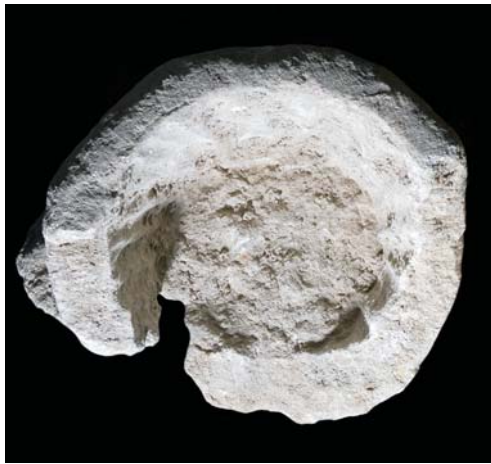

sf 904

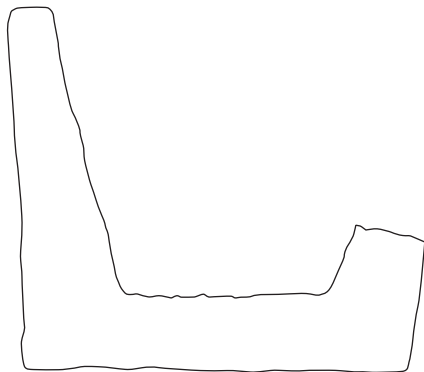

sf 872



1:4

Miscellaneous

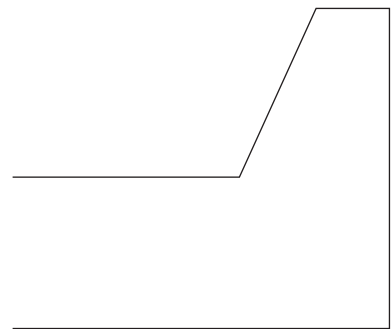

sf 945

0 250 mm

1:4

Miscellaneous



sf608



sf802

0 100 mm  
1:2

Miscellaneous