

## Excavation at Newbattle Abbey College Annexe, Dalkeith, Midlothian

John Gooder\*

with contributions by H Bush, N Crowley and A Heald

### ABSTRACT

*Excavation of a medieval cemetery associated with Newbattle Abbey at Newbattle Abbey College Annexe, near Dalkeith, Midlothian involved the removal of 127 inhumations and a large quantity of charnel. Evidence of medieval metalworking activity pre-dating an area of part of the cemetery was also uncovered. Nine stone-capped graves were discovered to the west of the abbey church. To the ENE of the abbey church the remains of a stone-built building, possibly part of an infirmary, were unearthed.*

### INTRODUCTION

Between June and October 2000, AOC Archaeology Group undertook an excavation at Newbattle Abbey College Annexe, near Dalkeith, Midlothian in advance of the laying of a new sewer by M J Gleeson Group plc on behalf of Stirling Water plc. Newbattle Abbey College Annexe is an industrial estate composed of small workshops occupying the buildings of a former military camp. It lies immediately to the north of Newbattle Abbey Adult Education College, once the site of the medieval Newbattle Abbey.

Approximately 600m south-east of Dalkeith, the site of Newbattle Abbey (NGR: NT 3335 6602) lay on a sheltered, level haugh with the River South Esk lying to the south. A Scheduled Ancient Monument, only part of the vaulted substructure of the eastern range of conventual buildings, incorporated within the present Newbattle Abbey College, survives above ground (illus 1).

The first foundation of the Cistercian monastic reform in Scotland was at Melrose

(1136), a daughter house of Rievaulx, Yorkshire (*The Chronicle of Melrose*). The rapid spread of the Cistercian order at this time is exemplified by Newbattle Abbey which was founded a mere four years later in 1140 by David I, probably in association with Earl Henry, with a colony from Melrose (Barrow 1973, 184). The location of the abbey was typically Cistercian and reminiscent of that of Melrose Abbey, a remote, wooded valley location near water at a distance from secular settlement. The name Newbattle (variously Niwebothla 1141, Newbotill 1295, Neubattail 1295, Nowbattle 1500, Newbottle 1825) is derived from the OE *neowe bottl* meaning ‘*new dwelling*’ (Johnston 1970, 262). Its church was dedicated to St Mary, as was the case in all Cistercian houses, in 1233/4 (Carrick 1907).

The early economic successes, based on wool production, of the Cistercian houses were largely derived from the efforts of large numbers of uneducated lay brothers (*conversi*) who undertook the agricultural and domestic labour on the estates. Newbattle Abbey was also involved in coal mining as early as the 13th

\* AOC Archaeology Group, Edgefield Road Industrial Estate, Loanhead, Midlothian EH20 9SY

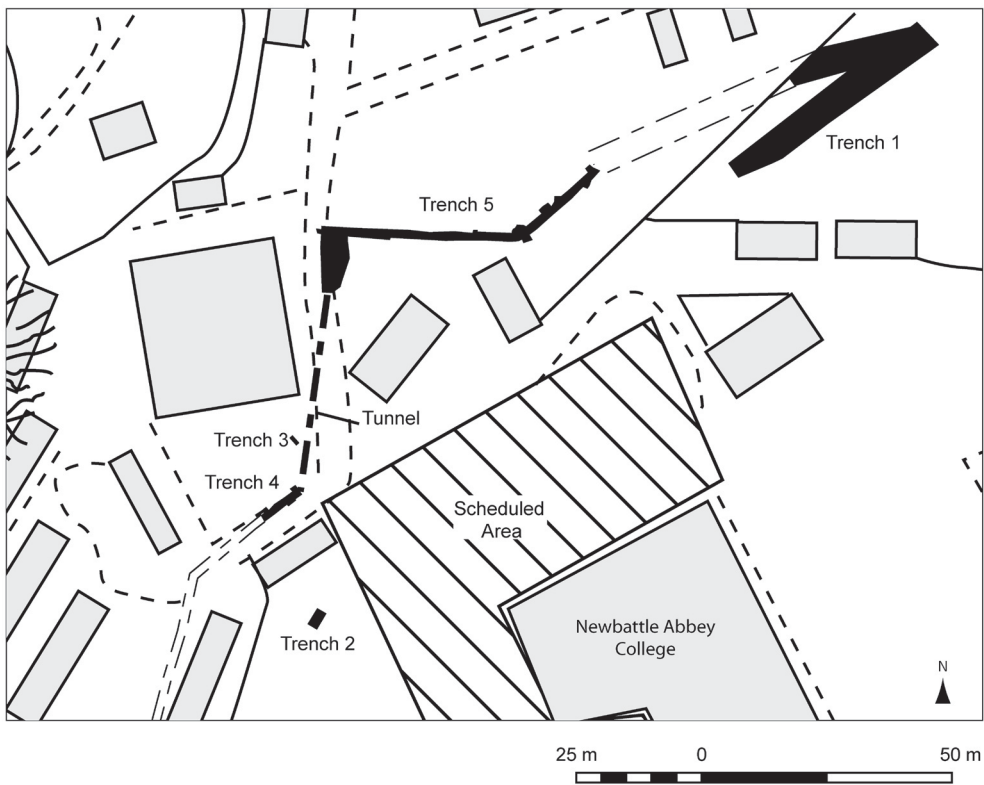
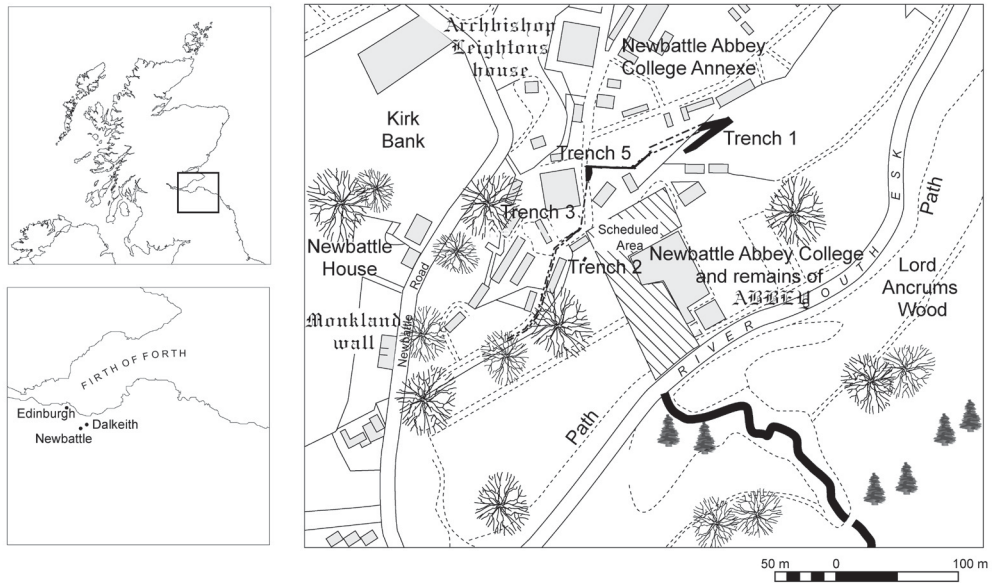

ILLUS 1 Location plan (Based on the Ordnance Survey map © Crown copyright licence 100016114)

century (Smith 2001, 234). Other economic interests would eventually include salt production, a stud farm, forestry and a deer park with estates, tithes and other land grants across central Scotland (Innes 1849).

By the end of the 13th century the abbey had an annual income of roughly £287 Scots (Duncan 2000). The numbers and importance of the lay brothers in Cistercian houses were diminishing at about this time (Burgess 1988; Oram 1998; Coppack 2000). Father Hay's estimate that the abbey still had 70 lay brothers in the late 14th century (Innes 1849, 234) is doubtful. Despite the fortunes of Cistercian houses being in decline from the late 13th/early 14th century (Coppack 2000), by the mid-16th century Newbattle's annual income had risen to £1500 (Cowan & Easson 1976, 72). The comparative economic importance of Newbattle at this time can be assessed by reference to the three major Scottish monasteries of St Andrews, Arbroath and Dunfermline where revenues ranged from £9600 to £12,500 (Dilworth 1995, 42).

In 1560, the last Commendator of the Abbey, Mark Ker, undertook extraordinary measures to retain his abbacy after his marriage and the birth of his son. The son (also Mark Ker) succeeded as Commendator in 1584, later retaining the abbey and its lands when it was secularized in 1587 (Dilworth 1995, 84). He became Lord Newbattle in 1591 and Earl of Lothian in 1606. This conversion of a monastic house into an aristocratic seat is more characteristic of the English Reformation than that of Scotland (Fenwick 1978). Demolition and conversion of the abbey church and claustral buildings began in 1580. The new mansion, originally the fraternity and portions of the chapter house (MacGibbon & Ross 1896), was extended in the 17th century, and a change to castellated architecture was adopted in the 18th century with further extensions and alterations in the 19th (RCAHMS 1929, 142–5, no 182). The mansion was created into an adult education college in 1936, with modern extensions built

in 1968. A stretch of precinct wall of uncertain date 'The Monkland Wall' (SDD 1964; RCAHMS 1929, 148, no 190) lies to the east of the abbey site.

The earliest abbey buildings at Newbattle were probably of uncomplicated timber construction. Similarly any original stone-built buildings are likely to have been architecturally unpretentious. In attempting a return to the original simplicity and rigour of the Benedictine rule, the Cistercians initially rejected developed monastic architecture (Coppack 2000, 23). Erosion of this architectural austerity began in the 1170s (Fawcett 2000, 47) and, although relatively plain architecture persisted through to the mid-13th century (Cruden 1960, 33), growing liberation from the Bernardine strictures is evident from this time. At Newbattle, it is only from this later period that we have evidence of monastic buildings.

## PREVIOUS WORK

Knowledge of the church/claustral complex is entirely derived from excavations undertaken from 1878 to 1895 by the then Marquis of Lothian. This work revealed fine ashlar masonry which spanned the early 14th to 16th centuries. A plan of the excavation was published by MacGibbon & Ross (1896, 251), which forms the basis of the RCAHMS plan (1929, 143, fig 189) (illus 3). The nucleus of the monastery measured approximately 86m east/west by 131m north/south. The church lay on the north. Its nave had ten bays, the presbytery and choir a bay and a half with a tower over the crossing with the transepts. The ground floor of the east range housed the library, vestry, chapter house and the sub-vault of the dormer and chambers below the rere-dormer. Above lay the dormer and rere-dormer. The south range comprised the day-stair, warming house, frater and kitchen. The west range was made up of cellage and lay-brothers' apartments (RCAHMS 1929, 142–5, no 182).

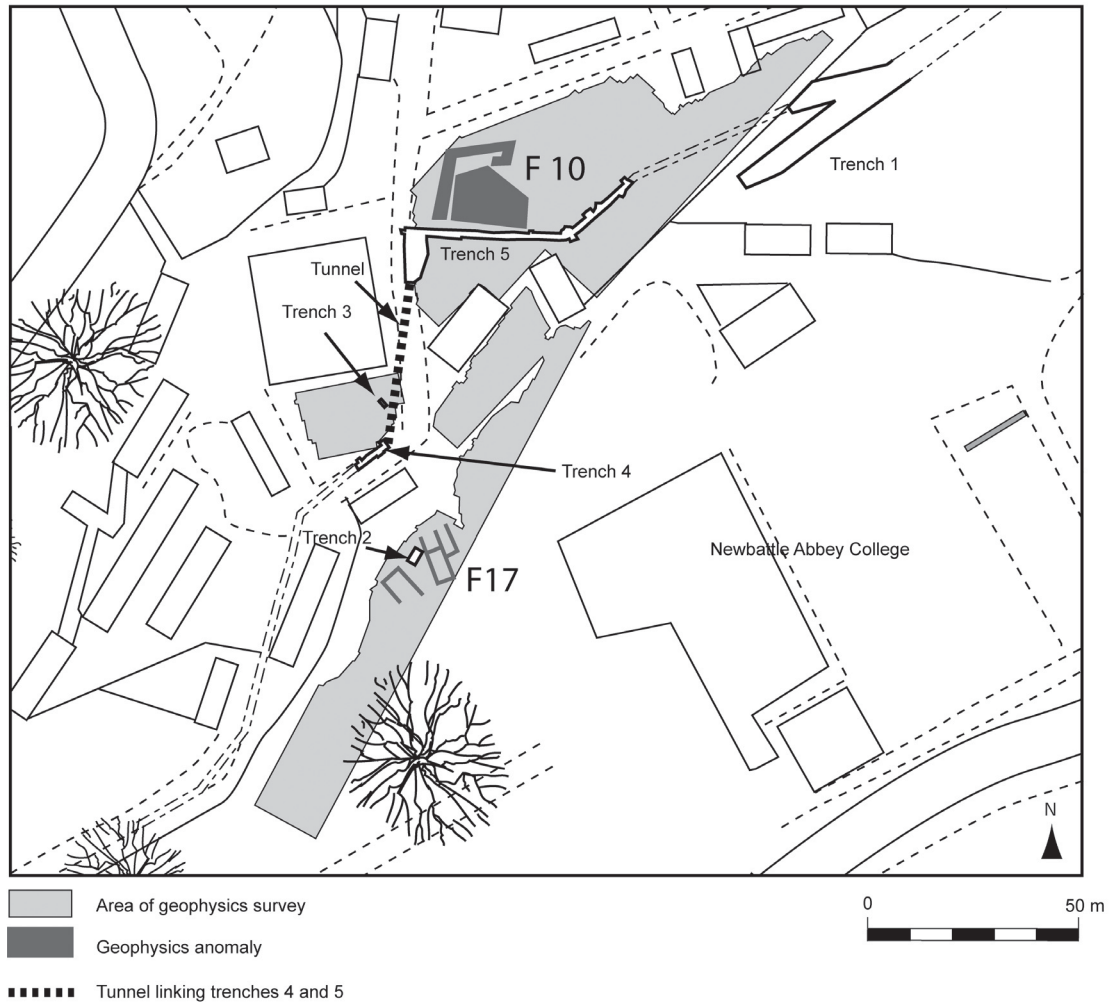

ILLUS 2 Area subject to geophysical survey (after (Noel & Newton 2000), fig 7)

Human remains were also unearthed by the late 19th-century excavations (Carrick 1903, 258), as were the foundations of the cemetery's curving perimeter wall (c 1m wide). To the north and east of the church, slate coffins were found near the chancel and north transept (Carrick 1907, 84).

In examining possible pipeline routes through the Annexe, fluxgate gradiometry and resistivity survey (Noel & Newton 2000) were undertaken in July 2000 (illus 2). Many of the anomalies identified in the area of Trench

5 where later found to correspond to former pathways associated with existing buildings. Two anomalies of particular interest were recognized. To the west of the abbey church lay a series of linear irregularities (F17) interpreted as either lines of stone coffins or walls (ibid, 7). To the north, a sub-rectangular zone possessing rectilinear subdivisions (F10) could represent the wall footings and debris of a building within the abbey precinct (ibid, 6). Elsewhere nothing was known of the precise number, type or distribution of the Abbey's precinct buildings.



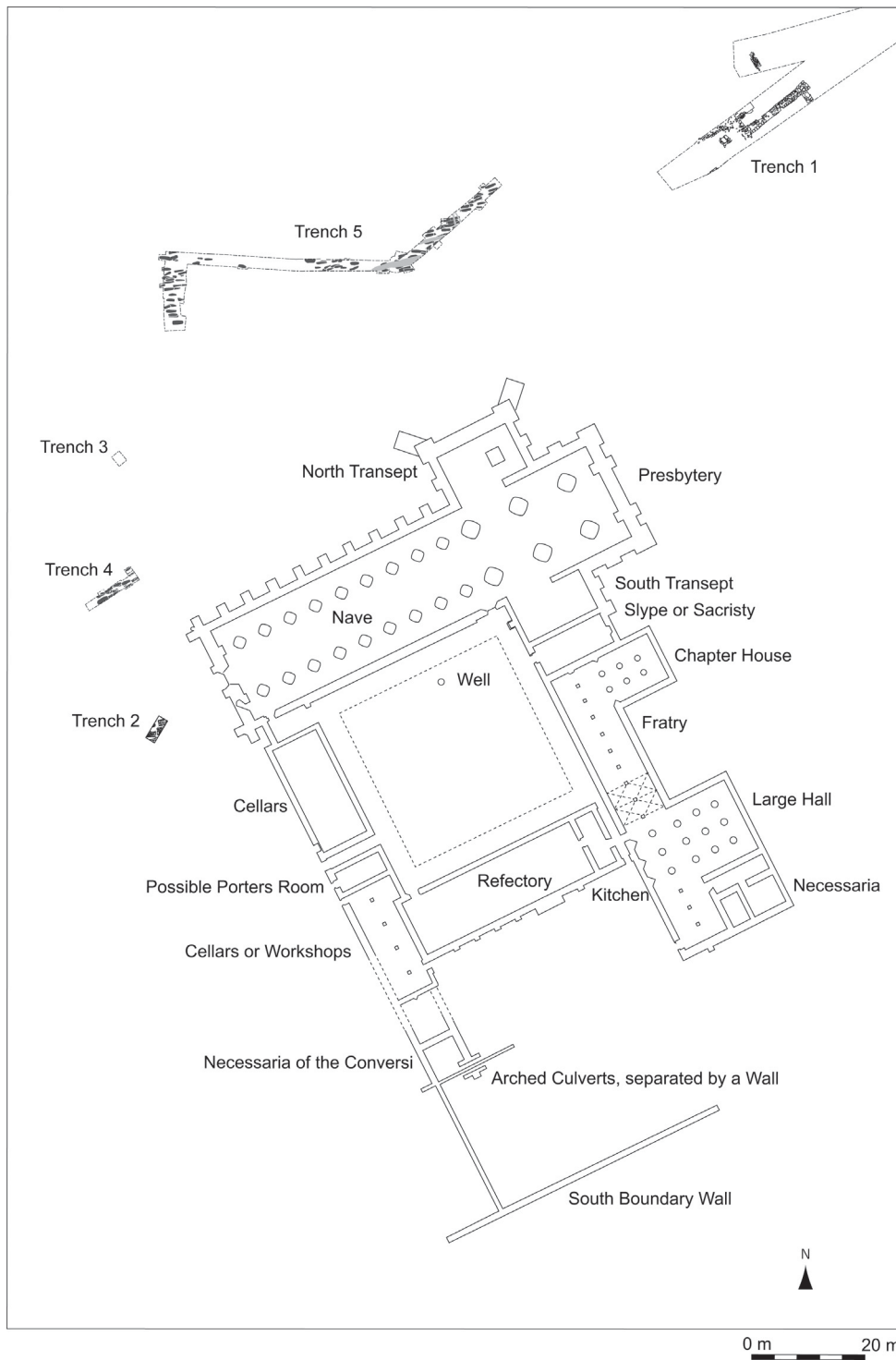

ILLUS 3 Plan of abbey (after RCAHMS, 1929, 143, fig 189) and trench locations

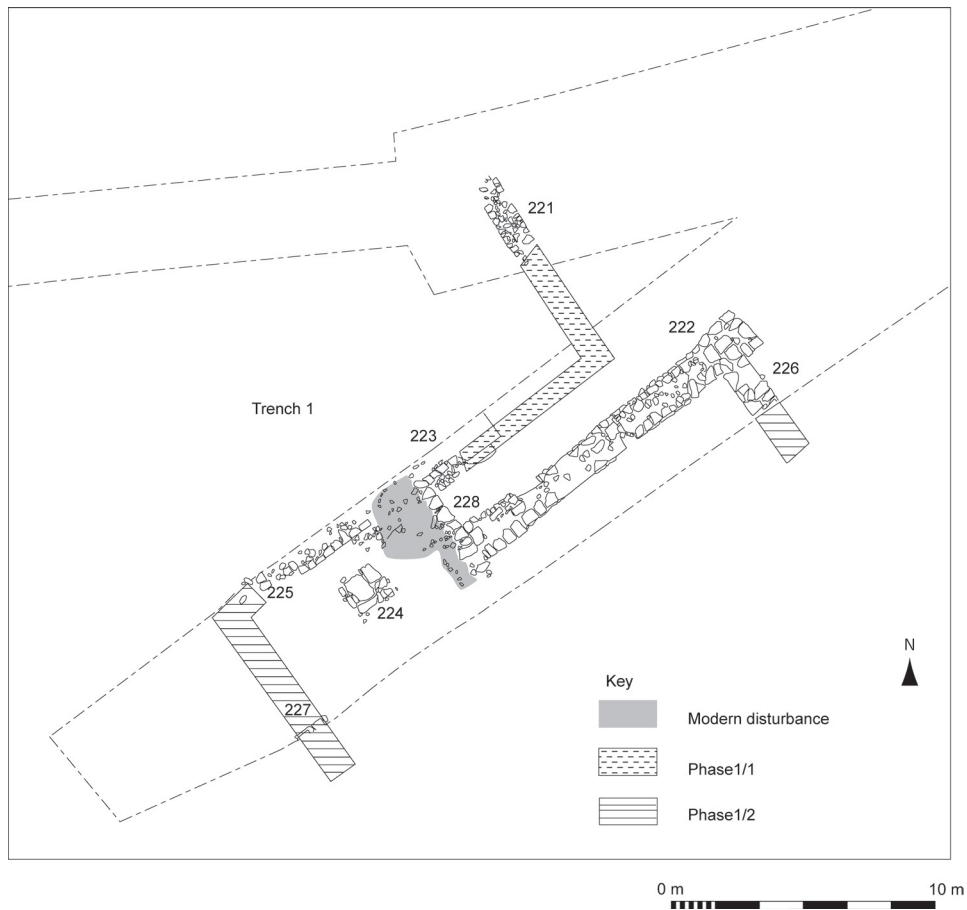

ILLUS 4 Trench 1

## EXCAVATION RESULTS

This excavation began as a watching brief monitoring ground reduction along the line of the sewer track. In June 2000 the remains of stone-built walls, in what became Trench 1, were discovered. Historic Scotland requested the preservation of these features. Trenches 2 and 3 investigated specific locations to ascertain the presence of significant archaeological features. The impossibility of pipe-laying works avoiding a medieval cemetery soon became apparent. The narrowness of Trenches 4 and 5 was an attempt to minimize any disturbance to human remains while permitting pipe-laying work to proceed

along the line of these two trenches (illus 2). In maintaining road access, pipe-laying between Trenches 4 and 5 was ultimately completed by the excavation of a tunnel which ran below the graves in this area.

### TRENCH 1 (illus 4)

Trench 1, approximately 6m wide and aligned east/west, lay to the ENE of the abbey church. Below 0.5m of topsoil lay the vestigial remains of possibly two phases of stone-built structures (illus 3 & 4). None of the features survived to any great height and directly overlay drift.

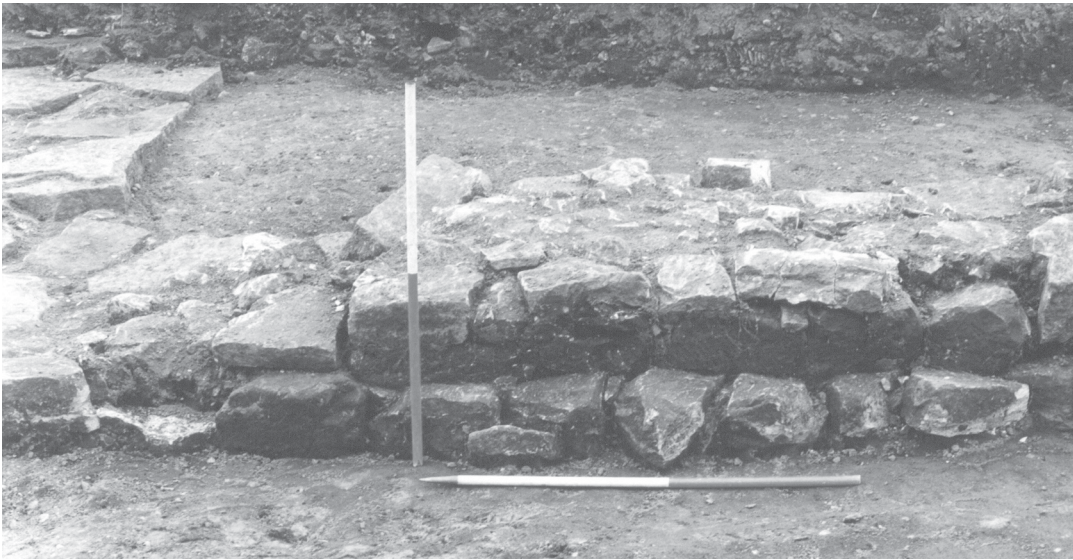

ILLUS 5 Detail of wall [222] (from north)

#### *Phase 1/1*

This phase is represented by the poorly-preserved remains of two walls. With no direct physical relationship between the two walls, their association is based merely on similar size, construction and extrapolated right-angled convergence. A 3m long stretch of a sandstone rubble built wall 221 lay near the western limit of 'Extension C' of Trench 1. About 1m wide and orientated roughly north/south, only the foundation course survived. No bonding was apparent. Within the main trench, the basal course of a 1.5m long section of wall 223 ran east/west at a right-angle to wall 221. Again of rubble construction, a number of rounded stones formed the southern face of the wall. It appeared truncated by wall 228 (Phase 1/2) at its western end although this area had been much disturbed. Indeed, it may be that the difference between these two nominal phases is functional or structural rather than chronological.

#### *Phase 1/2*

The individual elements of this phase shared the same architectural feature of a level, stepped

foundation course formed of large sandstone slabs (illus 5 & 6). Upper course work was predominately of undressed sandstone. The stonework was clay bonded and presented crude, flat elevations composed of uneven courses.

The principle element was a roughly WSW/ENE aligned wall (222). Some 13m long and generally 1.5m wide, it survived to a maximum of two rubble-built courses over the stepped foundation course. At its eastern end, in an area where only the foundation course survived, its construction was tied into a slighter wall (226), 1.1m wide, which ran off to the south (illus 6). To the west it abutted wall 228 which ran to the north before truncating wall 223. Unfortunately a disturbed area obscured the physical relationship between wall 228 and the similarly constructed east/west aligned wall 225 lying to the west. It may be surmised that this wall subsequently turned to the south joining with wall 227 which barely survived beyond the trench section. A square masonry feature (224) lay at the centre of the area enclosed by walls 225, 227 and 228. Measuring approximately 2m square and formed of flat sandstone slabs, it probably served as foundation plinth for a column.



ILLUS 6 Wall [222] during excavation (from NE)

Infirmaries are usually composed of a hall with single or twin aisles. As a broad rule, they tend to share the alignment of the monastic church (Tabraham 1984, 400) as does this building. Given the greater thickness of the main WSW to ENE wall 222 it must be assumed

that this is indeed the building's long axis. With a length externally of roughly 20m exposed, the width of the building remains unknown. No stratigraphically secure dating material was retrieved.

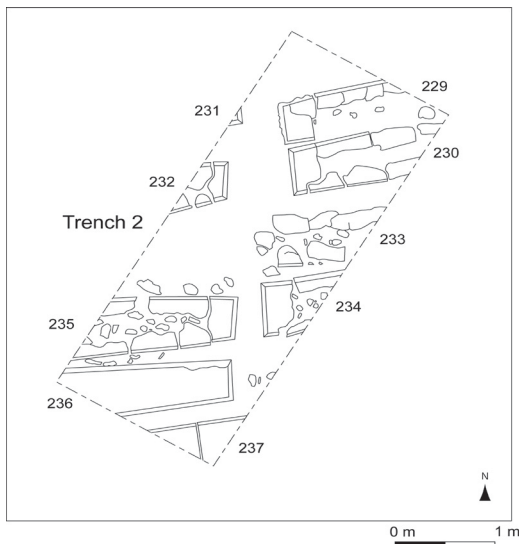

ILLUS 7 Trench 2

#### TRENCH 2 (illus 7)

Trench 2, aligned SSW/NNE, measured 4.5m by 1.8m and lay approximately 15m west of the entrance to the Nave (illus 7 & 8). Below 0.75m of made ground, nine recumbent grave slabs were uncovered. Densely packed, most were greatly damaged (illus 8). None of the grave slabs was completely exposed. Rectangular, with some tapering to the west, all were made of dressed sandstone, each slab averaging between 0.50–0.55m in width. Each side had broad, chamfered edges. In use throughout the medieval period, this type of grave slab was still popular in the 16th and 17th centuries (Willsher 1985, 19). These features were not excavated as the final line of the new sewer did not pass through this area.

Geophysics anomaly F17 (Noel & Newton 2000) probably represents a continuation of





ILLUS 8 Trench 2 grave slabs

these grave slabs in the immediate vicinity, although some elements of the anomaly may represent an enclosing cemetery wall.

#### TRENCH 3

Measuring 1m by 2m and orientated NNW/SSE, Trench 3 was located 25m to the NNW of the abbey church (illus 3). Excavation through modern overburden and a buried topsoil to a depth of 1.25m revealed a sandy cemetery soil containing one articulated, supine inhumation together with quantities of disarticulated human bone. No remains were removed as the final route of the pipeline did not impact on this area.

#### TRENCH 4 (illus 9)

With dimensions of 12m by 1.8m and orientated east/west, Trench 4 was situated some 15m NW

of the Nave (illus 9). The trench was extended where necessary to allow the complete removal of individual skeletons. Below 0.85m of modern overburden, the trench was found to contain 20 supine inhumations, generally in a poor state of preservation, within a homogeneous sandy cemetery soil 243 which ranged between 0.3m and 0.75m thick.

The graves were aligned roughly east to west, with all the burials observing the conventional Christian rite of extended inhumation with the head in the west. As is common with densely congested medieval cemeteries a considerable amount of grave inter-cutting had occurred with the truncation of early graves by later inhumations. As a consequence this created a considerable quantity of disarticulated bone lying within the grave fills and generally throughout the cemetery soil. Few grave cuts penetrated into the gravel drift. Here, as in



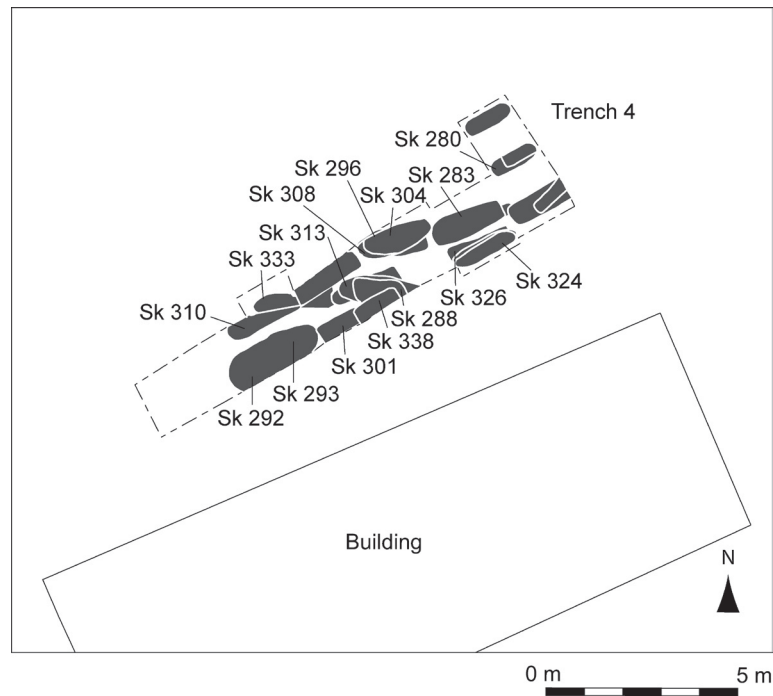

ILLUS 9 Trench 4

Trench 5, locating the edges of individual graves was often only possible by probing for the less compact nature of the grave fills. Both sexes were present as were juveniles and children. Given the lack of any evidence of coffins it is likely that all were shroud burials. This hypothesis was supported by the common discovery of individuals' leg and arm bones lying in constricted positions.

The deliberate gathering and re-deposition of disturbed remains 305, 312 and 338 appeared to be represented by the graves of Sk 338, 312 and 338 respectively. Skeletal material, especially long bones and crania, presumably disturbed by the digging of a new grave, was collected and placed in a discrete bundle to one side of the new interment, rather than just being tossed back into the new grave. A similar practice was recorded at the later first millennium AD cemetery at Kirkhill, St Andrews (Wordsworth & Clark 1997, 8).

#### TRENCH 5 (illus 10)

Trench 5 lay within Newbattle Abbey College Annexe to east of the main access road. The main part of the trench, roughly 68m long by 1.8m wide, formed a flattened V-shape on plan. Broadly aligned east to west, it turned to the south-west at its western end for a further 11m. Here its width was increased up to 4m to encompass any burials that would be impacted upon by the pipe laying works (illus 10). Several stony surfaces and former pathways of modern date were encountered below the turf. Three phases of earlier activity were identified below these features.

#### *Phase 5/1: industrial activity*

Pre-dating the graves in a densely occupied part of the cemetery lay two small dark spread deposits 408 and 481, both roughly 0.04m in depth. These features overlaid an area 569 only

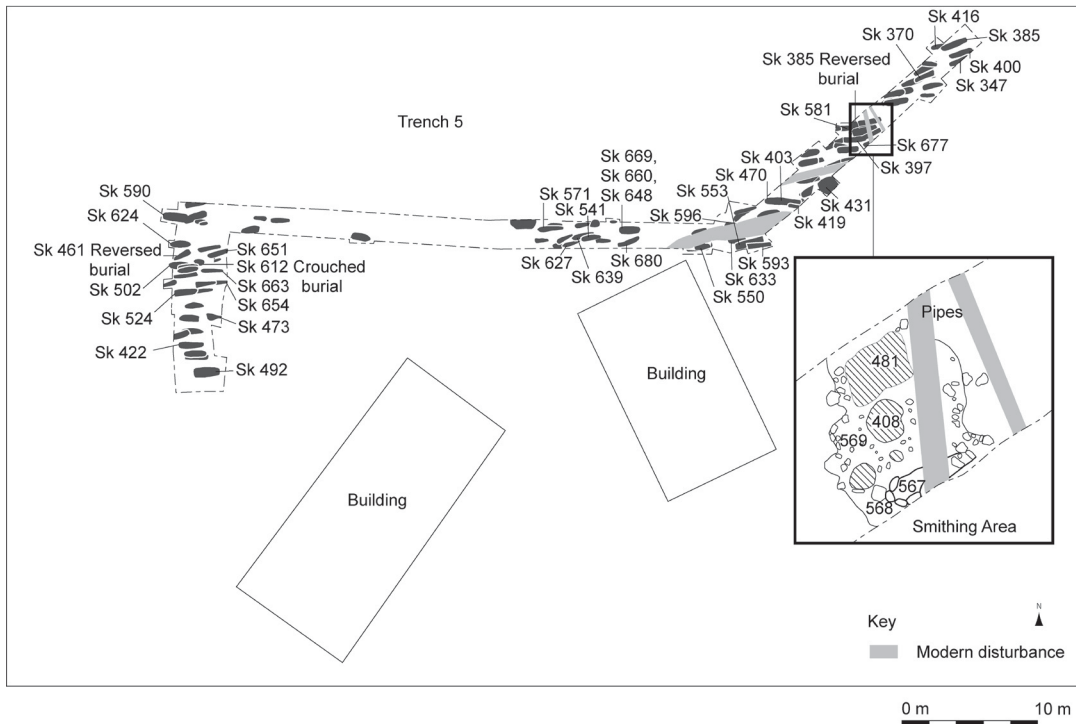

ILLUS 10 Trench 5

partially exposed and measuring 1.8m by 2.0m, where blackened stones and the orange colour of the soil matrix reflected transformation by in situ burning. Interpreted as the remains of a smithing hearth (Heald below) this feature probably dates to the late 12th or early 13th century, AA-49339 (AD 1160–1245) and AA-49340 (AD 970–1160), and may correspond with the period of initial building work at the Abbey. Evidence of smithing has occurred at other religious houses, notably at Black Friars, Perth (Photos-Jones & Atkinson 1998, 900).

*Phase 5/2: cemetery*

A shallow topsoil overlay a cemetery soil 345, ranging from between 0.4m to 1.1m thick, and containing 107 articulated inhumations in varying states of preservation. As in Trench 4, extensive grave truncation had occurred and, again, few graves penetrated into the gravel

drift. Both sexes were present throughout the entire length of the trench as were juveniles and children. As in Trench 4, some phasing of burials was obvious as attested by the slightly varying alignments of groups or individual burials. The tendency varied, from predominately WSW/ENE, sharing the orientation of the abbey church, to true east/west orientation. All but three were extended inhumations with the head in the west. Skeleton 385 and Sk 461, probably dating to the 15th or 16th century, AA-49332 (AD 1490–1640) and AA-49331 (AD 1440–1620), were reversed with the head in the east. Skeleton 461 may indicate a hurried burial, as the skeleton lay on its left side with the left arm under the body and left leg bent. Alternatively Sk 461 and Sk 385 may have been priests, in keeping with the tradition that priests would arise to face their flocks at the resurrection, although Rahtz (1978, 4) notes that this custom was not common prior to the Reformation. Adult inhumation Sk 612,

probably dating to the second half of the 13th century, AA-49259 (AD 1220–1300), was in a crouched or foetal position lying on the right side and aligned roughly NE/SW. The left arm lay around the skull, with the right arm bend down towards the pelvis. Hypotheses suggested in regard to the atypical positioning of ‘normal’ Christian inhumations has been discussed by Bowler et al; these range from post-mortem muscle contraction, the inadvertent burial of individuals who were still alive and who subsequently struggled to free themselves or the deliberate burial of an individual in a natural sleeping position (1995, 943–4).

Only one grave, that of Sk 590, produced evidence of a coffin burial. Iron nails within grave fill 589 defined the extent of a sub-rectangular grave-cut measuring 1.80m by 0.74m. The only other evidence of grave furniture appeared as the apparent framing of the skull of Sk 677 (probably mature male) by stone setting 568 (illus 10).

Multiple inhumations occurred in grave-cut [661]. Sk 660 (mature female) lay immediately to the north of Sk 648 (child 6–7 years), with another skeleton of a child, Sk 669 (1.5 to 3 years), lying to the lower left. Radiocarbon dating of Sk 660, AA-53690 (AD 1280–1390) and AA-54283 (AD 1295–1395) and the elder child Sk 648, AA-53692 (AD 1285–1390), indicates probable 14th-century burials. The first date, AA-49334 (AD 780–980), from Sk 660 is considered to be a rogue result.

Two individuals, Sk 663 and Sk 431, probably adult males, appear to have survived sword or blade attacks to the head, with Sk 301 (adult male) possibly also subject to violent assault. The abbey suffered during three English raids. It was burnt in 1385 by Richard II and his uncle, John of Gaunt with many monks taken prisoner (Carrick 1907, 54). Fired again in May 1544 by a force under the Earl of Hertford during the ‘Rough Wooing’ of Henry VIII, it never really recovered from this attack. The final assault occurred in June 1548 (Cowan & Easson 1976, 77). The alleged ferocity of the

English attack of 1385 provides a speculative occasion for the injury to Sk 431, AA-49338 (AD 1295–1395).

### *Phase 5/3*

Debris from the 16th-century demolition of abbey buildings, or from one of the 14th- or 16th-century destruction episodes, occurred throughout the cemetery soil and in Trenches 2 and 4. This material included mortar spreads, mosaic floor tile, roof tile and moulded stone fragments (see Crowley below).

## HUMAN BONE

Helen Bush

The assemblage consisted of 127 individuals, specifically 90 adults (71%), 29 children and juveniles (23%), with a further eight individuals (6%) insufficiently represented to state with any certainty if they were adult or juvenile.

The completeness of the skeletal remains was generally poor with 70% assessed as fragmentary, 15% partial and only 10% assessed as almost complete. Preservation was also generally poor with fewer than half being considered to be in good or moderately good condition. This has meant that intra- and inter-site comparisons of demographic structure and prevalence of pathological conditions were generally not possible, with the exception of dental pathology. Eleven per cent of the 895 adult teeth examined had carious lesions, which is considerably higher than reported for other Scottish medieval sites. The focus of attention has of necessity been mainly at an individual rather than population level with the remains revealing an unreduced dislocation of the shoulder, two probable sword wounds to the head (both of which were survived), an avulsion fracture of the spine of a thoracic vertebra and subsequent infection, and a range of other conditions, both pathological and variations of normal morphology. All methods and diagnostic

TABLE 1  
Numbers of sexed and unsexed adults

<i>Sex</i>	<i>Number</i>	<i>Percentage</i>
Male	20	20
Male (? or ??)	24	24
Female	8	8
Female (? or ??)	12	12
Unsexable	34	35
Total	98	100

criteria employed in this study are explained in the full report contained within the site archive.

#### SEX ATTRIBUTION

Of the 90 adults, an assessment of sex was made for 64 (71%) individuals. There were 44 males or possible males and 20 females or possible females. Thirty-four other individuals (35%, including the eight who could not be assigned as adult or juvenile) were considered to be unsexable, primarily because the completeness and/or preservation was inadequate. All individuals assessed as 'query' male and 'query' female were included with the more securely sexed individuals for analytical purposes (Table 1).

#### AGE ATTRIBUTION

##### *Children and juveniles*

Eighteen individuals have an age-at-death between birth and 14 years (Table 2). Sk

TABLE 2  
Distribution of estimated age-at-death of children and juveniles

<i>Age (years)</i>	<i>Number</i>	<i>Percentage</i>
0–4	7	24
5–9	7	24
10–14	4	14
14–21	10	34
Unknown	1	4
Total	29	100

581, assessed schematically as 18 months old (plus/minus three months), was considered to be approximately two and a half years old, confirming the Molleson & Cox (1993) finding of under-ageing for this stage.

##### *Adults*

Because of the large number of skeletons which could be aged using only a single feature or which could not be categorized except as young, middle-aged or mature, age at death has been reported by three broad adult groupings: young (20–35 years), middle-aged (36–49 years) and mature (50 years and older). A similar approach has been carried out elsewhere, as in the case of the medieval cemetery assemblage from Nethergate, Dundee (Brown & Roberts 2000). Table 3 shows the distribution of estimated adult age-at death by sex, and Table 4 details the separate age groups as a proportion of the total sample.

TABLE 3  
Distribution of estimated adult age-at death by sex

<i>Adult age group</i>	<i>Male</i>	<i>Female</i>	<i>Unsexable</i>	<i>Percentage</i>
Young	10	6	3	21
Middle-aged	14	7	0	23
Mature(>50 yrs)	11	3	2	18
Adult	9	4	21	38
Total	44	20	26	100

TABLE 4  
Age groups as a proportion of the total sample

<i>Age group</i>	<i>Number</i>	<i>Percentage* of sample</i>
Immature (<19)	29	24
Young (20–35 yrs)	19	16
Middle-aged	21	18
Mature (>50 years)	16	13
Adult	34	29
Total	119	100

\* as a percentage of all individuals, excluding eight not categorized as adult or juvenile.

#### POPULATION VARIABILITY

##### *Stature*

Only 14% of adults (seven males and six females) were sufficiently well-preserved for their stature to be estimated. Male height ranged from 1.63m to 1.72m, and female height from 1.50m to 1.66m. The right femur of Sk 492 (young adult, male) was found to measure 337mm (maximum length), some 87mm shorter than the shortest female femur. The left tibia was very slightly bowed which, together with the marked and extensive dental enamel hypoplasia which this young man had experienced in childhood, is suggestive of rickets. However, no other features of this disease were apparent, and the bowing may reflect mechanical stresses. The short femora and enamel hypoplasia are certainly suggestive of episodes of growth disruption.

##### *Cranial non-metrical traits*

Retention of the metopic suture (which is normally fused by two years of age) is thought to be inherited, as Brothwell (1981) has noted, although its frequency in five families buried in the Spitalfields crypt was not higher than for the sample as a whole (Molleson & Cox 1993, 129). Metopism (the non-closure of the suture between the two halves of the frontal bone of the skull) was observed in ten adults from the Newbattle Abbey assemblage, but although two

(Sks 397 & 677) were buried in close proximity this could well be coincidental, and there was no evidence elsewhere of any clustering which might indicate a family group.

The presence of ossicles in the lambdoid suture had caused ‘bunning’ of the occipital bone in three males (Sks 382, 593 & 639). Sk 593 had a large, single ossicle immediately to the left of lambda (the point at which the sagittal and lambdoid sutures meet), and at least three large ossicles to the right; advanced fusion of the lambdoid suture made it difficult to determine the exact number. The size of these ossicles had distorted the back of the cranium. Sk 639 had approximately seven ossicles in the right lambdoid suture, so that the bunning was asymmetrical.

The wisdom of recording cranial non-metrical data could be questioned given the very little that can be said about them, but it was considered appropriate to record as much as possible since the assemblage will be reburied.

##### *Skeletal anomalies*

The absence of the medial condyle of the right humerus in Sk 283 (male, mature) and of the tuberosities of the left and right fifth metatarsals in Sk 288 (male, young adult) was noted, while the right navicular tarsal of Sk 593 had a separate tubercle. Sk 403 (male, middle-aged) had an anomalous left third tarso-metatarsal joint, the facet for the third metatarsal being pitted; unfortunately the articulating metatarsal was not present. The condition is peculiar to the third tarso-metatarsal joint, and its cause and significance are completely unknown (Rogers & Waldron 1995, 30). In Sk 624, the anterior border of the articular facet of a foot phalanx was found to lie higher up the bone shaft than is usual.

In a number of adults, the bones of the feet, and in one case the hands, were found to have lytic lesions for which no cause was obvious, and which have often been observed in other skeletal assemblages (Stroud, pers comm).



Developmental abnormalities of the vertebral column are comparatively common, and may have underlying genetic factors (Lanier 1954, cited by Stroud 1993, 195). Three individuals had anomalous vertebral facets, Sks 680, 296 & 624. Vertebral anomalies often occur at transitional points in the spine, and five individuals had abnormalities at the lumbosacral level. Sk 310 exhibited symmetrical sacralization of a sixth lumbar vertebra, the additional vertebra fused with the top segment of the sacrum. Sacralisation of the fifth lumbar vertebra was noted in two individuals: Sk 553 (male, aged 17–25), who also had extensive Schmorl's nodes, and Sk 422 (female, aged 30–39). She also had Schmorl's nodes on three vertebrae.

Skeleton 370 and Sk 639 each had a detached neural arch of the fifth lumbar vertebra. This condition, known as spondylolysis, probably develops from a congenital weakness of the neural arch, the posterior portion of the vertebra which surrounds the spinal column. Recurrent stress induced by bending and lifting causes a number of small fractures at the point of weakness until a total fracture occurs so that the arch and body become separated and are held in place by soft tissue (Manchester 1983, 58). Sk 639 (male, aged 17–19) also had a detached neural arch of the fifth lumbar vertebra, but the inferior surface of the arch, at the point where the two halves fuse, is billowed and roughened, with the appearance of a healed but unremodelled fracture. He was also noted to have cranial lesions for which a diagnosis is not clear.

#### *Dental anomalies*

Seven individuals had one or more teeth rotated from their normal positions; nine teeth in total were recorded, seven being rotated mesio-buccally and two disto-lingually. Rotation was generally slight, but the mandibular second premolars of Sk 624 and the maxillary second premolar of Sk 324 were estimated to have rotated by approximately 45 degrees. Two

individuals with rotated teeth had other dental anomalies: maxillary lateral 'peg' incisors were found in one (Sk 651), while three third molars were considerably reduced in size in another (Sk 612). In addition to rotation, seven teeth were mal-aligned. The third molar was the only tooth noted to be congenitally absent. Ten maxillary and twelve mandibular molars were not present, with a further mandibular molar possibly absent although ante-mortem loss could not be excluded.

#### PATHOLOGY

##### *Dental pathology*

**Children and juveniles** Nine children had deciduous dentitions, represented by eight maxillae and eight mandibles, again in various degrees of completeness; the teeth of one child were not in situ. Of the 180 deciduous teeth which theoretically could be present, 93 (52%) were available for examination. No teeth had been affected by caries, but three dentitions were noted to have deposits of calculus (calcified dental plaque); one child, estimated to be aged between five and seven years, had mild, and in two cases, moderate deposits of calculus on 14 of the 18 teeth present.

The permanent dentitions of 18 children and juveniles were recorded. Four individuals had a total of five teeth affected by caries (dental decay), with a further three teeth being considered to have precarious staining. Supragingival calculus (above the gum-line) was noted on at least one tooth of all 13 children and juveniles with enamel surfaces available for assessment, with just a single tooth being considered to have a heavy deposit. No periapical cavities were noted.

**Adults** The maxillae of 15 females, 25 males and seven unsexable adults were available, as were the mandibles of 14 females, 33 males and seven unsexable adults; the unsexable material has been included in the analysis to make use of

all available data. Some 895 (29%) of a possible 3136 teeth were present.

Eleven per cent of the 895 teeth examined had carious lesions. This is considerably higher than the 3.7% reported for Nethergate (Brown & Roberts 2000) and the 5% reported for the Carmelite Friary at Aberdeen (Cross & Bruce 1989). It is also somewhat higher than the 6% said to be 'consistently observed at other medieval sites' (ibid, 81). For the sample as a whole, molar teeth were most likely to be carious, then premolars and lastly canines and incisors. As in other assemblages, posterior teeth were most likely to be carious compared with anterior teeth. While more posterior than anterior teeth were present, as already noted, there was a considerable percentage difference, with 21% of molars being carious, compared to 2% of incisors and canines. This difference is not explained by caries originating in the occlusal crevices of molars, since the most frequently affected sites were mesial (n=40) and distal (n=23), with only 15 occlusal lesions being identified. However, for ten molar and premolar teeth where more than half or the entire crown had been destroyed by caries, it was not possible to identify the site of the lesion's origin, and it may therefore be that the difference in frequency of site of origin is not as great as it appears. Precarious lesions were recorded where observed as brown stains in the enamel on the mesial and distal surfaces of posterior teeth.

Hillson (2000) has provided a detailed description of the cavities which develop at the roots of teeth and of the diagnostic criteria which differentiate the various types. Fourteen periapical cavities were recorded in the Newbattle dentitions. Eight were located at the first molar, and of the other six, two were recorded at the second premolar and one each at a third molar, a first premolar and a first incisor. Of these, nine were identified as chronic abscess cavities because of the presence of a clear sinus through which they would have drained.

Heavy or very heavy attrition of the tooth crowns was noted in seven (19%) of 32 males

with at least one tooth, one (6%) of 17 females and one (13%) of eight unsexable individuals. All were judged to be middle-aged or mature, except one male and the unsexable individual who could only be categorized as adult.

Some degree of calculus (mineralized dental plaque) was recorded for most adults in the Newbattle assemblage, and in a few cases was seen to extend onto the roots of the teeth; in one case 13 teeth were affected. In life, this calculus would have penetrated behind the gums, that is, it would be sub-gingival, leading to periodontal disease. Pitting of the bone in response to inflammation and the formation of new bone are clear signs of periodontal disease (Roberts & Manchester 1995, 56). New bone was seen in association with an infrabony defect and sub-gingival calculus (Sk 283, mature adult); in a second case (Sk 612, adult) new bone had been laid down on the buccal surface at the mandibular right first molar, and there was considerable resorption and pitting of the alveolar bone at the second and third molars. Clear infrabony defects were also observed in three other adult dentitions.

#### *Dental enamel hypoplasia*

Dental enamel hypoplasia was noted in the permanent dentitions of 29 adults, three juveniles and four children, affecting at least one tooth. No deciduous teeth were found to be affected. In one severe case (Sk 296, middle-aged female) the enamel was absent from the incisal third of the maxillary anterior teeth, with most of the other teeth present being heavily grooved. The absence of the enamel suggests an insult of some severity occurring in early childhood which obviously had been survived. A juvenile (Sk 473) who had between one and four hypoplastic grooves on each of the 18 permanent teeth which were present may well have been weakened by the insults which caused these disruptions, since he/she had died by the age of 21. A similar picture can be painted for Sk 324 (aged 11 to 14) who had between one

and four grooves on 11 of 26 permanent teeth. In addition to hypoplastic grooves on each of the five permanent teeth which had survived, hypoplastic pitting on the lingual surface of the mandibular right central and left lateral incisors was noted in Sk 633 (aged seven to eight).

#### *Joint disease*

Because bone can only react to disease in a limited number of ways, an affected joint may have been caused by any one of a range of diseases, although the location of the lesion within the joint itself and in the wider context of the body may aid diagnosis (Rogers & Waldron 1995, 4). Roberts & Manchester (1995, 100) have concluded that the complete skeleton is required for accurate diagnoses of joint disease. Tentative diagnoses have been offered where possible and appropriate in this report.

**Osteophytes** These are growths of new bone at the margin of a joint which vary greatly in size and shape (Rogers & Waldron 1995, 1). They are very frequent in skeletal assemblages, and would seem to be a normal part of the ageing process, so that when found in the absence of other abnormalities, they are unlikely to be pathological (*ibid*, 25). In the Newbattle assemblage, a very frequent finding was ‘lipping’ of joint margins, particularly of the vertebral bodies and facets, and of the edges of the articular surfaces of the metacarpals and metatarsals. The ubiquity of this finding and the fact that it was seen in juveniles and young adults, supports the proposal that such changes are part of the ageing process. They were recorded routinely but have not been analysed.

**Degenerative disc disease** This presents as coarse pitting, occasionally with new bone development, on the superior or inferior surfaces of the vertebral bodies; both surfaces of an individual vertebra may be affected. It frequently appears in conjunction with osteophytosis of the body margins, and these changes are taken to

represent degeneration of the inter-vertebral disc (Rogers & Waldron 1995, 33). The porous changes of degenerative disc disease were recorded in the vertebrae of seven adults (four male or possibly male, three female or possibly female). In six of these, it was the discs between the cervical inter-vertebral discs which had been affected, notably the third, fourth and fifth. Stroud (1993, 207) also found the cervical vertebrae to be most affected, although in a much larger sample. Possible degenerative changes were recorded in five other adults.

**Osteoarthritis** Sk 288 (male, young adult) had marked changes to the articular surfaces of the distal humerus and proximal radius, with eburnation and exuberant overgrowth of the radial head. There was also eburnation of the distal ulna, which corresponded to eburnation on the lunate and scaphoid bones of the wrist with which it was in articulation, and osteophytosis and eburnation of the left first metatarsal distally. Osteoarthritic changes were present in the mandible of the scant remains of Sk 308 (probably male and of mature years). The right condyle was flattened and porous with some eburnation, and the anterior border was lipped. The right mandibular fossa, in which the condyle would have sat, was enlarged and roughened, with some porosity but virtually no osteophyte formation. The logic of Rogers & Waldron’s proposal (1995, 33) that osteoarthritis represents an attempt by a joint to repair itself can be seen when viewed in the light of these examples.

Less marked (non vertebral) changes were recorded in a small number of other individuals. The assessment of the prevalence of vertebral osteoarthritis in the Newbattle Abbey material was compromised by poor preservation. The frequency and distribution of osteoarthritis of the vertebral apophyseal joints are detailed in Table 5. The vertebrae were too fragmentary to determine the total number of facets available and so it has not been possible to make a comparison between total present and total

TABLE 5  
Frequency and distribution of osteoarthritis of the apophyseal joints of the vertebrae.

		<i>Superior facets</i>		<i>Inferior facets</i>		<i>Superior facets</i>		<i>Inferior costal facets</i>	
		L	R	L	R	L	R	L	R
Male (n=10)	Cervical	3	1	0	0	–	–	–	–
	Thoracic	1	5	2	7	17	17	12	13
	Lumbar	6	9	5	2	–	–	–	–
Female (n=6)	Cervical	0	0	0	0	–	–	–	–
	Thoracic	1	0	0	0	5	1	5	7
	Lumbar	3	1	1	0	–	–	–	–

affected. The comparatively large number of affected costal facets in males is misleading, since one individual contributed 30 of the 59. In terms of frequency, the joints most frequently affected were the head and neck of the ribs and the vertebra, either continuous osteophytes and/or porotic changes, or extensive osteophytes, porotic changes and possible eburnation. Of the 19 individuals, seven were women and, as would be expected, the majority of cases occurred in middle-aged or mature individuals. Of the three 'young' adult females noted to have rib changes, two were considered to be in their thirties, so youth was relative here. The young adult male was considered to be between 25 and 31 years.

The lack of hip or knee involvement, and the comparatively large numbers of affected ribs, must be attributable to the overall poor preservation of the assemblage, particularly given the numbers of middle-aged and mature adults, since these are the two most frequently affected joints both in modern and in archaeological population studies (Roberts & Manchester 1995, 125).

**Lytic/cystic lesions** In three cases, small lytic lesions were seen at the margins of the articular joint surfaces. Sk 593 was noted to have a smooth-lined, sharp-edged lytic lesion at the proximal end of the left fourth metatarsal, unusually on the dorsal surface. Its smoothness is suggestive of a cyst. In Sk 288 (male, young adult) the

combination of osteoporosis and erosive lesions at the joint margins of the hip, elbow, wrist and sacro-iliac is suggestive of tuberculous arthritis, although the involvement of more than one joint is unusual (Rogers & Waldron 1995, 92). Infection of the lower spine generally occurs, but although the lower thoracic vertebrae were unfortunately not present, there was no involvement of the lumbar spine. Sk 660 (female, middle-aged) also had several lytic lesions, but of a quite different appearance, having irregular margins and cavities beneath the articular surfaces, the lining of which, where observable, was not smooth. In addition, the cervical vertebrae had been affected by a destructive process which had partially eroded the inferior surface of the bodies of C2–C4 and C7, and the superior surface of the bodies of C4–5 and especially C3. There was also a suggestion of this process at the posterior margin of the superior surface of T1. There was osteophytosis inferiorly at C3–4 and superiorly at C5–6. Cortical erosion of the right hamate and capitate bore a resemblance to the less severe vertebral damage, but could be post-mortem damage. However, a second opinion confirmed that the process affecting the vertebrae was pathological. The lesions of the vertebra and also of the carpals correspond to the 'moth-eaten bony destruction' (Rogers & Waldron 1995, 95) produced by fungal diseases, although these are rare in Europe and difficult to distinguish from other infectious disease.

**Schmorl's nodes** These affect the vertebral bodies, appearing in the dry bone as indentations on the superior and/or inferior surfaces. They are caused by a prolapsing of the intervertebral discs into the body, possible as a consequence of trauma or vigorous physical activity (Schmorl & Junghanns 1971, cited in Stroud 1993). The nodes are most common in the lower thoracic and lumbar vertebrae (Rogers & Waldron 1995, 27) and according to Stroud (1993, 214) have been generally reported to occur more frequently in males than females.

Ten males or possible males and four females or possible females had an average of five nodes each (range one to fifteen nodes). As in reports of other assemblages, the inferior body surfaces were affected more frequently than the superior (37 as opposed to 28). The highest vertebra affected was the fifth thoracic (inferior), and the lowest the fifth lumbar (inferior); in the medieval assemblage from Fishergate, York, Stroud (1993, 215) found the highest and lowest affected vertebrae to be the fourth thoracic and the fourth lumbar (superior surface). Of the nine juveniles in the sample, four had a complete spine, a fifth had a complete lumbar spine but no other vertebrae, and a sixth had a very poorly preserved spine. No Schmorl's nodes were found on any vertebra from these six juveniles.

**Osteochondritis dissecans** This is a lesion in the bone beneath the cartilage which covers the joint surface, and it is caused by damage to the cartilage, probably traumatic in origin. The defect is considered to be over-diagnosed palaeopathologically (Roberts & Manchester 1995, 89; Rogers & Waldron 1995, 28). Three such were found in the Newbattle material, in two young adults Sk 654, male and Sk 627, probably female and in a juvenile, Sk 541.

There was one example of probable osteochondritis dissecans since it was roughly triangular, porous and was located on the distal condyle of the left femur. This was in a male estimated to be over 60 years of age (Sk 596). The literature does not discuss the possibility of

loss of these lesions through the remodelling of bone, and this may be a defect which occurred in youth and was retained into maturity.

#### INFLAMMATION AND INFECTION

The most marked inflammatory lesions in the assemblage were noted in Sk 310, a middle-aged male. It was apparent several bones in his lower limbs were roughened, thickened and grainy. Considerable dental pathology and wear of the tooth crowns had afflicted this individual so that eating must have been difficult. It is possible that he was malnourished as a consequence, which could have compromised his ability to fight the infection which affected his legs. It is also possible that the primary source of infection was his dental abscesses, bacteria from which would be transported through the bloodstream. He would probably have been 'seriously ill with fever, pain and immobility' (Manchester 1983, 36) as a result of this skeletal infection which was evidently a chronic condition, because of the time required for such osseous change to occur (*ibid*, 35). The fact that these marked bone changes are present indicates that this man survived for some considerable time, and that his body had fought the infection.

Non-specific inflammation of the tibiae is commonly seen in archaeological material, presenting as pitting, longitudinal striations or graininess, and new bone laid down on the cortical surface. Because the tibia lies close to the surface of the skin it is commonly subjected to trauma, which may underlie the 'superficial and insignificant inflammation of the lower legs' (Roberts & Manchester 1995, 130). Sk 310 had evidently suffered from something more significant, which should perhaps be classified as osteitis, since not only was there some periosteal new bone but considerable misshaping and marked graininess of the distal tibiae and fibulae. This example confirms Wells (1982, 182) suggestion that periostitis, osteitis and osteomyelitis are overlapping rather than discrete conditions.



A less marked inflammation was present in Sk 385 (adult, unsexable), indicative of an injury to the tibia, from which the inflammatory process radiated. A small fragment of left tibial shaft from Sk 502 (adult, possibly female) exhibited a slightly grainy surface, with a suggestion of new bone having been laid down, but the fragmentary nature of the remains precluded any determination of the extent of this lesion. A very small fragment of right tibial shaft was also grainy with some possible new bone formation. Sk 304 (aged 12–16) had an intermittent trace of periosteal new bone at the mid-shaft of the right humerus along a length of about 80mm. No other abnormality was detected.

On Sk 550 (adult) several areas of the long bones and scapula had new bone laid down upon them. The anterior surface of the left femur was grainy with some new bone, and there were similar but more marked changes on the posterior surface; a metatarsal was thickened with a roughened and grainy surface. Because this skeleton is only partial, the full extent of these lesions is not known, but it would seem that this individual was suffering from a condition which affected a considerable area of the body, assuming that the lesions have a common cause.

In two individuals, Sk 593 (middle-aged male) and Sk 627 (young, possibly female), new bone had been laid down on the inner surface of the ribs. No other evidence of infection was seen in either of these almost complete and well-preserved skeletons. Skeletal lesions of tuberculosis may be restricted to the inner surface of the ribs (Kelley & Micozzi 1984), and a diagnosis of TB can therefore be considered here.

## INJURY

### *Fractures*

One female and seven males had one or more skeletal lesions diagnosed as a healed fracture; these included two individuals with fractures of

the spinal column, Sk 639 and Sk 310, a middle-aged male. The latter appears to have suffered an avulsion fracture of the spinous process of the sixth thoracic vertebra, which would have been caused by a sudden muscle contraction. The healed spinous process is malaligned, which was probably caused by the jerk of the muscle, possibly a ‘clay-shoveller’s fracture’ (Roberts & Manchester 1995, 78). Since Newbattle Abbey had mining interests (Knight 1999), we can speculate that the fracture may indicate this man’s occupation at one time. The extensive infection of the leg bones of this man was noted above.

### *Cranial trauma*

An injury consistent with being inflicted by a blade was present in the left parietal bone of Sk 663, who was probably male and in his thirties. Running almost parallel with the lambdoid suture, this is a depressed wound of approximately 65mm long which is shallow posteriorly. At its medial extremity, close to the sagittal suture, the wound has penetrated the inner cranial table, but there is no indication of infection and the wound edges are well-healed, indicating that it was not fatal. On the right parietal of Sk 431 (probably male, young adult) is an area from which the outer table has been ‘skimmed off’, as if by a sweeping blade, revealing the cortical bone beneath. It resembles the injury to the outer table of the skull illustrated in Manchester (1983) and described by him as caused by a ‘tangential swipe’ (ibid, 60) with a flat, very sharp sword. The wound was well-healed at death. Lastly, two circular, shallow depressions are present in the anterior third of the left parietal of Sk 301 (probably male and of mature years); the cortical bone of the outer table has not been damaged. Such lesions could be caused by a blow to the head. On the frontal bone, approximately 25mm above the left superior orbital margin, is a shallow circular lesion of about 6mm in diameter with slight striations

on its surface. The margin is flat medially but rounded superio-distally. It is not convincing as a blade injury, but neither is it obviously post-mortem damage. The cause is unknown, but may be traumatic in view of the lesions of the left parietal and a rib fracture.

#### *Other injury*

In archaeological remains, a dislocated joint can only be recognized if it remains unreduced, that is, out of alignment, which may explain why they are not often seen (Roberts & Manchester 1995, 87). An unreduced dislocation of the head of the right humerus was diagnosed in Sk 571, a male of mature age. The joint changes were so extensive that this feature could not be identified at first sight. The margins of the glenoid fossa of the right scapula were thickened, and the articular surface was roughened and pitted. These are likely to be osteoarthritic, fitting in with Rogers & Waldron's proposal of the joint's attempt at self-repair. On the anterior surface of the scapula, adjacent to the glenoid fossa, a secondary, curved articular surface has been created by the head of the humerus; this area is approximately 3cm at its widest point, and roughly 5cm long. Extra bone has built up behind this surface, but the extent of this is not known since most of the blade has been lost post-mortem. Less than half the humeral head has survived, but what remains has a tear-shaped area of roughened, pitted bone, which presumably has resulted from articulation with the new articular surface which would not have been covered by cartilage. It is not known what length of time would be required for such a degree of remodelling to occur, nor the extent to which this individual could use the damaged arm. Assuming that this injury was the result of trauma, it is likely to have been excruciatingly painful, at least in the acute phase, and would probably have caused chronic discomfort in its malaligned state. It cannot be said whether any attempt had been made to realign the joint; it might be expected that there would be at least

one individual at the abbey with the knowledge of how to treat such an injury, although of course he may not have been injured in its vicinity.

#### POROTIC HYPEROSTOSIS

This is a pathological condition of the skull which presents as pitting on the external surface of the cranium and, in more marked cases, as proliferation of the trabecular bone and destruction of the outer table. The lesions of the condition are known as *cribra orbitalia* when they present in the orbits of the frontal bone, and are held to be the initial focus of bony change (Stuart-Macadam 1986). In recognition of Stuart-Macadam's (1982; 1985) submission that porotic hyperostosis represents anaemia experienced in childhood, the frequency of orbital and vault lesions was calculated separately for children of 14 years or less and for juveniles and adults. No lesions were recorded from the 12 vault surfaces of children which were available for study. This may simply reflect the very small sample size, although a complete absence of vault lesions was reported in 44 vault surfaces of children under ten years from the Romano-British Bath Gate cemetery at Cirencester (Bush 1989). Stuart-Macadam (1986) proposed that *cribra orbitalia* detected in the absence of vault lesions may attest to the mildness of the anaemia, and in the Bath Gate children, no orbital lesions were severe. In the Newbattle material, three of the five orbital lesions are in the moderately severe categories, but with such a minute sample no conclusions can reasonably be drawn. Similar results were noted from excavations at the Carmelite friaries at Linlithgow and Aberdeen, while no evidence of *cribra orbitalia* were found in the Perth Carmelite cemetery (Cross & Bruce 1989).

A smaller percentage of individuals aged 15 and older than children had orbital lesions. Three were juvenile, two were female (one young, one middle-aged), four were male (two young, two middle-aged), and one was unsexable. Of these,

only one (Sk 627, young female) had what was considered to be an active vault lesion of mild severity.

Although a direct relationship between porotic hyperostosis and dental enamel hypoplasia cannot be argued (Stuart-Macadam 1985, 396), it is likely that an individual whose health in young life is compromised by failure to withstand the physiological insult which results in hypoplasia might be more susceptible to anaemia. It could also be argued that an individual weakened by anaemia would be more likely to succumb to insult. A statistically significant association between the two conditions was found in the Romano-British material from Cirencester (Bush 1989). In the Newbattle Abbey material, five of the 11 individuals with cribra orbitalia had at least one tooth affected by hypoplastic grooves; however, there was considerable post-mortem dental loss and the teeth of one middle-aged individual were heavily worn, so again no conclusions can be safely drawn. It is worth noting, however, that two of the five individuals had reached middle age, so had evidently been strong enough to survive the conditions which had caused enamel growth disruption and anaemia.

#### DISCUSSION OF THE SKELETAL REMAINS

Roughly equal numbers of men and women would be expected in a 'normal' cemetery population, but a little over twice as many male skeletons as female were identified. This may be a spurious ratio because 35% of adults were unsexable. The finding of twice as many men as women in an assemblage in which only a very small number could not be categorized would lead to questions as to whether this reflected bias in excavation or sexing methods, or whether it reflects the true nature of site, in this case monastic.

The age profile at Newbattle is certainly distinctive. The 24% of immature individuals (younger than 20 years of age) is lower than some other medieval sites. At Nethergate,

Dundee, for example, 28% of the sample was aged 18 years or less which was said to be comparable with other Scottish medieval sites (Brown & Roberts 2000, 78). Thirty-seven per cent of the late 10th to 12th century burials at Fishergate, York were less than 20 years of age. If the number at Newbattle is genuine, it could reflect the period of time during which adult males would have been the primary occupants of the Abbey. The figure is not explained entirely by the poor preservation, since the remains of young children generally survive less well than others, but it could be due to sampling bias as a result of the incomplete excavation of the cemetery.

Forty-one per cent of the adults were considered to be middle-aged or mature adults. Given the large number to whom age and/or sex could not be attributed it would be wrong to interpret this finding in terms of their health status, although evidence from a number of monastic sites in England suggests that their inhabitants enjoyed a higher standard of living than others in the population (Stroud 1993, 255).

Some cases provide vivid evidence of the potential for chronic suffering and, in the examples of probable sword injuries to the head (Sk 431; Sk 663), swift and bloody assault. A mature male, Sk 310, had suffered both acute injury and chronic disease, showing evidence of possibly related conditions of osteitis of the legs and extensive dental pathology, a vertebral fracture and apparently further infection at its site, and a developmental anomaly of a vertebra which might have caused back pain, as would the repeated friction of bare bone sufficient to produce the angular and highly polished vertebral facets in Sk 370. Although it cannot be said with any certainty what pain was suffered by individuals in whom pathological conditions are identified, partly because pain thresholds vary between individuals, the unreduced dislocated shoulder of Sk 571 is surely clear and sad testimony to acute pain followed by a long period of disability.

## POTTERY

Naomi Crowley

The excavation produced a small assemblage of 37 medieval pottery sherds.

### SCOTTISH WHITE GRITTY WARE (SWGW)

This highly fired white, pinkish or grey coloured fabric is currently dated from the late 12th to the 15th century. Previous work has identified three potential production centres for this fabric in Lothian, Borders and Fife (Haggarty 1984, 395; Hall 1997, 56–8) with recent ICPS research suggesting many kilns situated across the country. Both glazed jugs and cooking pots appear to be represented. Sherds of this pottery occur within the graveyard topsoil and grave fills in Trench 5 and make up the majority of the pottery from the site.

### YORKSHIRE TYPE WARES

Two medieval English sherds dating to the 13th or 14th century were unearthed. A green glazed jug sherd with a thumbled base can be identified as Scarborough Ware (Trench 5, 435). The second sherd, from a yellow glazed jug, is from an unidentified Yorkshire source (Trench 5, graveyard soil 345).

### GLAZED REDUCED WARE (GRW)

This dark green glazed, heavily reduced, grey coloured fabric (mid-15th to mid-18th centuries) was first identified in excavations at Stirling Castle (Haggarty 1980). Four green glazed jug sherds occurred in the topsoil from around the walls encountered in Trench 1.

### DISCUSSION OF THE POTTERY

The small assemblage contains mainly medieval pottery, particularly Scottish White Gritty Ware, but very little post-medieval and later pottery. The presence of pottery imported from Yorkshire would not be unusual on a monastic site.

## BUILDING MATERIALS

Naomi Crowley

The excavation produced a small but interesting assemblage of medieval ceramic and moulded stone building material originating from the Abbey itself. The majority of this comes from contexts in Trench 5 and includes plain mosaic floor tile, glazed roof tile, stone and mortar.

### FLOOR TILE

The excavation produced three fragments of floor tile which would have been used in a plain mosaic floor and date to the 13th century. The fabric is a red coloured sandy fabric with varying amounts of lighter clay streaks, and a reduced grey-coloured core. The topsoil above the graves in Trench 2 produced an incomplete triangular floor tile. The surface is worn but there are traces of green glaze on the sides of the tile. The tile has been scored along the surface before firing to give the option of a triangular or a square tile to the floor layer. A sandy deposit (435) in Trench 5 produced an incomplete square floor tile with traces of dark green glaze and a hollow in the centre of the base, for keying mortar and to prevent warping during drying and firing. The fill of a modern pipe trench produced an incomplete triangular floor tile with traces of green glaze.

These tiles are identical to those found at Newbattle Abbey during excavations between 1878 and 1895, and undoubtedly come from plain tile mosaic floors in the Abbey. Wasters and structural material found at Newbattle indicate that these tiles were made at or near Newbattle (Eames 1980, 72–82). Plain mosaic tiles are earlier than other types of decorated medieval tiles, dating to the 13th rather than the 14th century. Most of the known tile mosaic is from the north of England and Scotland, and was widely used by the Cistercians both on the Continent and in Britain. Cistercian Houses in Yorkshire at Byland, Rievaulx and Meaux, and in Northumberland at Newminster Abbey all have similar plain mosaic pavements. Cistercian

Houses are known to have had large numbers of lay brothers, including competent craftsmen, during the 13th century when these pavements were laid.

#### ROOF TILE

The excavation produced eight fragments of ceramic roof tile in a red coloured fabric with quartz sand and dark red iron oxide inclusions. The topsoil over the graves in Trench 2 produced two joining fragments of curved roof tile with a yellow glaze and 2 fragments of flat roof tile. Grave 342 in Trench 5 produced a fragment of unglazed flat roof tile. The tile fragments vary in thickness from 13mm to 17mm. Thick glazed roof tile is a early form of ceramic roofing dating to the 13th or 14th century.

#### STONE & MORTAR

The excavation of Trench 5 produced four fragments of moulded stone in a pale coloured sandstone. These are likely to have come from demolished walls, doorways and windows of the Abbey.

Three mortar samples were collected for examination. Two samples from deposit 436 in Trench 5 were both the same off white sandy lime mortar; presumably demolition debris originating from the Abbey. The sample from the graveyard soil 345 in Trench 5 appears to be lime without any aggregate, perhaps from the mixing of a mortar for building work or from its use in the graveyard.

#### METAL & SLAG

Andrew Heald

#### IRON OBJECTS

##### *Chisel*

Small Find 104, Trench 5, (435) – the chisel is solid, unsocketed, and has an expanded striking platform and the blade tip is lost. Corrosion hinders definition of the section of the chisel, although it is clearly faceted, possible hexagonal. This heavy-duty chisel could have been used by a blacksmith, carpenter or stonemason (Manning 1985, 21). Length 195mm; width at top 16mm; width at bottom 16mm.

TABLE 6  
Distribution of slag by type and context

<i>Context</i>	<i>Description</i>	<i>Bloom-working hearth bottom</i>	<i>Prill, cinder, hammerscale</i>	<i>Smithing, hearth lining</i>	<i>Vitrified Material</i>	<i>Unclassified</i>
345	Graveyard soil	290.4			10.0	
424	Fill of grave	189.8			15.3	
529	Modern fill		11.5			
679	Fill of grave		5.4			
461	Fill of grave		1.1			
623	Fill of grave		0.4			
449	Fill of grave		0.8			
427	Fill of grave		2.3			
626	Fill of grave		3.2			
409	Fill of grave		0.6			
565	Fill of grave			56.9		
569	Industrial area			277.2		
Unstrat					17.4	
396	Fill of grave				0.1	
435	Sand lense					40.1
Total		480.2g	25.3g	334.1g	42.8g	40.1g



*Key for mounted locks and padlocks*

Small Find 55, Trench 5, (345) – kidney-shaped bow key with solid stem which projects to a well-defined point and narrows below the head of the bit. The bit is symmetrical, for use from either side of the door. The two wards surround a central opening. The key is similar in shape and size to examples from London of 15th/16th century (London Museum Catalogue 1940, 141–5, fig 43; type VIIb). Similar examples are known from Winchester, dated to between the 12th and 16th centuries (Goodall 1990, 1007, 1033–5, fig 329). Length 181mm; bow height 54mm; width 35mm.

*Nails*

Thirty-three nails were found in seven grave fills, the majority from grave fill 589 (Sk 590). Four nails came from the Trench 5 graveyard soil 345. The intact nails cluster between 35–49mm in length, although the overall range is 15–79mm. This pattern is mirrored in head size where there is one main group, 10–15mm across, again with individual outliers. There is no correlation between head size and intact size and the broken nails cannot be brought into discussion. The majority of the Newbattle nails are typical carpentry nails found on many Medieval sites; the smaller examples are clout nails (see Long & Long 1983, 279–80, fig 13). Their association with skeletons and presence of adhering wood suggests these nails were used in coffin construction. That only seven grave fills contained nails is of interest, perhaps reflecting differences in burial practice. Equally, this could be related to taphonomy and/or preservation. Further, many of the graves only produced one nail, suggesting that these may have become accidentally incorporated into the grave fills (see below). Indeed, only grave fill 589 has a sufficient quantity of nails which could realistically construct a coffin.

## LEAD OBJECTS

Five amorphous pieces of lead nodular waste, probably molten debris, were found. Four were from grave fills and were likely to have been accidentally incorporated into the fills during burial. Lead is common on many medieval church sites, used for roofing and windows.

## SLAG

*Method*

As a general rule, it is assumed that slag derives from the smithing process unless proved otherwise (McDonnell 1986). Only the presence of ore and tap slag is definite evidence of iron smelting. Identification was based on the morphological study of the internal and external areas of the object, analysis of weight, density, colour, streak, texture, porosity and inclusions (after Bachmann 1982; McDonnell 1986; Spearman 1997). Non-destructive EDXRF analysis was undertaken on a limited number of pieces.

*The residues*

A total of 922.5g of slag was collected. The slag has been described and catalogued using common terminology (McDonnell 1986; Salter 1991; Spearman 1997). The following subsections give a short description of each of the slag types. The vast majority of the metalworking debris relates to smithing, either bloomsmithing or the manufacture and/or repair of wrought-iron artefacts. The remaining material is either hearth lining or amorphous vitrified material, comprising either burnt organic and/or fused masses of sand, clay and silica. These are indicative of a high temperature process and not a direct by-product of metalworking.

*Bloom-working slag*

Two bloom-working slags, weighing 480.2g, were recovered. Both have a matt grey pimply exterior with a porous interior, and inclusions of charcoal, cinder, and more vitreous slag. One (Small Find 144) is a plano-convex hearth bottom. These are lenticular accumulations of slag that developed in the hearth during the working of blooms.

Small Find 144 – Fragment of plano-convex smithing hearth bottom. Outer surface nodular in texture. Dark grey in colour and section. Much of the slag is fairly

dense although there are zones of porosity with an abundance of red oxide powder indicating active corrosion of an iron rich zone. Length 95mm; height 44mm; width 63mm; weight 290.4g. Trench 5, (345).

Trench 5, (424) – Smithing debris. Outer surface nodular in texture. Dark grey in colour and section. Much of the slag is fairly dense. Length 82mm; height 48mm; width 43mm; weight 189.8g.

#### *Hammerscale, slag spheres, prill and cinder*

25.3g of prill, hammerscale, slag spheres and cinder were recovered. Hammerscale waste consists of small flakes of iron produced by the impact of hammers on hot iron during either the refining of iron blooms or the working of wrought iron.

#### *Smithing hearth lining*

Seventeen pieces of hearth lining were recovered, weighing 334.1g. These are created either by direct fusion of the clay lining during heating or fusion helped by the fluxing of the fuel in the hearth. All are reduced grey in section with vitrification on one face showing evidence of heating, with charcoal inclusions (<10mm) and silica within the matrix. Although in many sites they are indicative only of a pyrotechnic process (Salter 1987; 1991; McDonnell 1986) the magnetic content and small inclusions of iron scale within the examples suggest that they are fused masses of material formed during the smithing process.

Small Find 141, Trench 5 (565) – Four pieces and smaller residues of smithing hearth lining. Weight 56.9g.

Small Find 150, Trench 5 (569) – 13 pieces of smithing hearth lining. Weight 277.2g.

#### *Distribution*

All of the slag was recovered from Trench 5 and found in a variety of contexts. The majority of the slag is very small and is best seen as residual, most being re-deposited in grave fills. One area (569/404/481) appears to represent an area of smithing activity.

## RADIOCARBON DATES

A comprehensive programme of single-entity AMS dating was undertaken in elucidating the

development of the cemetery. The dates were obtained from the University of Arizona via the Scottish University Research and Reactor Centre (SURRC). The dates were calibrated by SURRC using the OxCal3 program. While radiocarbon dating has precision limitations within the Medieval period, multiple results can be tied to stratigraphic evidence and historical references in yielding enhanced accuracy. For example, Sk 333 (sample 2) provided a  $2\sigma$  date range of AD 1020–1220; as the abbey was founded in 1140 and assuming no earlier occupation of the site, which is likely given this was a Cistercian foundation, this particular burial likely occurred in the period AD 1140–1220.

## DISCUSSION

The excavation, albeit necessitated by engineering and environmental concerns rather than archaeological research priorities, has nevertheless provided valuable information on the scale, development and composition of a Cistercian cemetery in addition to unearthing the remains of a precinct building.

### CEMETERY DEVELOPMENT

The cemetery, its location somewhat atypical in being placed to the north of the claustral complex, was consecrated by the first Abbot, Ralph (died c 1160) (MacGibbon & Ross 1896). An exhaustive programme of radiocarbon dating was undertaken in an attempt to elucidate the evolution of the cemetery. The date ranges cited below are all at the one sigma ( $\sigma$ ) confidence level. Not unexpectedly the graves in Trench 4, lying close to the site of the abbey church, appear to be the earliest. Of the five skeletons dated in Trench 4 (Sk 333 was subject to two dates given an unrealistically early first result), the two skeletons representing initial interments, Sk 293 (male?) (AA-49257) and Sk 333 (female?) (AA-53691) both of which were cut by later inhumations, yielded a date range

TABLE 7  
Radiocarbon dates

<i>Skeleton</i>	<i>Laboratory code</i>	<i>C14 bp</i>	<i>d13C(‰)</i>	<i>Range</i> 68.20%	<i>Range</i> 95.40%	<i>Notes</i>	<i>Trench</i>
Sk 280	AA-49336 (GU-9948)	530±45	-20.7	1320–1440	1300–1450	Child	4
Sk 292	AA-49327 (GU-9935)	850±40	-19.1	1160–1255	1040–1280	Male	4
Sk 293	AA-49257 (GU-9936)	925±50	-17.7	1030–1170	1010–1220	Male?	4
Sk 326	AA-49333 (GU-9944)	860±40	-19.8	1060–1250	1030–1270	Female	4
Sk 333	AA-49258 (GU-9937)	1065±50	-17.2	890–1030	870–1160	Female?	4
Sk 333 sample 2	AA-53691 (GU-10721)	915±45	-20.7	1030–1170	1020–1220	Female?	4
Sk 347	AA-49330 (GU-9040)	485±50	-20.3	1400–1460	1310–1620	Sex?	5 (east)
Sk 385	AA-49332 (GU-9943)	330±45	-19.4	1490–1640	1450–1650	Male?	5 (east)
Sk 400	AA-49328 (GU-9938)	400±40	-19.8	1440–1620	1430–1640	Sex?	5 (east)
Sk 416	AA-49329 (GU-9939)	560±40	-20.4	1320–1430	1300–1440	Male?	5 (east)
Sk 419	AA-49261 (GU-9950)	810±55	-18.9	1180–1280	1040–1300	Child	5 (east)
Sk 431	AA-49338 (GU-9953)	630±45	-19.7	1295–1395	1280–1410	Male, blade injury	5 (east)
Sk 461	AA-49331 (GU-9942)	400±40	-20.0	1440–1620	1430–1640	Male?, reversed	5 (west)
Sk 470	AA-49335 (GU-9947)	400±40	-20.7	1440–1620	1430–1640	Female	5 (central)
Sk 524	AA-49260 (GU-9946)	870±55	-19.6	1040–1240	1030–1270	Female	5 (west)
Sk 571	AA-49262 (GU-9952)	710±50	-16.3	1250–1390	1220–1400	Male, chronic injury	5 (central)
Sk 612	AA-49259 (GU-9941)	750±60	-19.3	1220–1300	1160–1400	Male?, crouched	5 (west)
Sk 633	AA-49337 (GU-9949)	660±40	-20.3	1285–1390	1280–1400	Child	5 (central)
Sk 648	AA-53692 (GU-10722)	660±45	-17.1	1285–1390	1270–1410	Child	5 (central)
Sk 660	AA-49334 (GU-9945)	1140±40	-21.2	780–980	770–990	Female, with Sks 648 & 669	5 (central)
Sk 660 sample 2	AA-53690 (GU-10720)	675±45	-19.4	1280–1390	1260–1440	Female	5 (central)
Sk 660 sample 3	AA-54283 (GU-10723)	635±40	-20.8	1295–1395	1280–1410	Female	5 (central)
Hearth 481-1	AA-49339 (GU-9954)	845±35	-27.0	1160–1245	1040–1280	Smithing hearth	5 (east)
Hearth 481-2	AA-49340 (GU-9955)	1010 ± 55	-27.3	970–1160	890–1170	Smithing hearth	5 (east)

of AD 1030–1170. Given that the abbey was founded in 1140, these were probably amongst the cemetery's first burials.

During the early years of the Abbey, the desire for burial in proximity to the church is evidenced by the stratigraphically later burials Sk 292 (male) (AA-49257) which cut Sk 293 (AA-49257), and Sk 326 (female) (AA-49333) overlying Sk 328, proving only slightly later with date ranges of AD 1160–1255 and AD 1060–1250 respectively. The child burial, Sk 280 (AA-49336), an intrusive burial truncating Sk 273, provided the latest date, AD 1320–1440, in Trench 4.

Burial in the area of the western part of Trench 5 had soon spread from the area of Trench

4. Sk 524 (female) was dated to AD 1040–1240. It appears to have taken until the 14th century for the cemetery to extend its farthest eastwards, subsuming the former smithing area (569/404/481) in the process. Sk 416 (male?), overlain by Sk 353 and Sk 364, being the earliest dated inhumation (AA-49329), 1300–1440, at the easternmost limit of the cemetery. The other two skeletons dated in this area, Sk 400 (AA-49328) and Sk 347 (AA-49330) probably had a 15th- or 16th-century burial.

The dating evidence corroborates historical references to the cemetery going out of use with the secularization of the site in the latter half of the 16th century, the abbey church being robbed of stone at this time for the building of the new

parish church, with local burials now occurring there (Carrick 1907).

#### CEMETERY COMPOSITION

As at Melrose Abbey Chapter House, where the burial of both sexes of the lay community is recorded after 1215 (RCAHMS 1956, 283), both sexes are represented. The cemetery traverses a distance of 105m from the eastern and western limits of the burials in Trenches 4 and 5. It is possible that the break in the distribution of burials (centred around the isolated Sk 606) in Trench 5 could indicate the presence of two different cemeteries. As women and children were recovered from both areas, any hypothesis about a permanent cemetery specifically for choir or lay monks is untenable, at least in the area investigated. That the central and eastern areas of Trench 5 typically lack the earlier dates recorded in Trench 4 and the western part of Trench 5, may be demonstrative of the general expansion of the cemetery eastwards.

Four female and one probable female inhumation were dated: Sk 326, Sk 470, Sk 524, Sk 660 and Sk 333 (female?). Women were found to occur amongst the very earliest burials (see Sk 333 and Sk 524). Four child inhumations were dated: Sk 280, Sk 419, Sk 633 and Sk 648. The earliest, Sk 419, lying in the central part of Trench 5, was dated to AD 1180–1280 (AA-49261). The latest, Sk 280 in Trench 4, was dated to AD 1320–1440 (AA-49336).

Social differentiation is evidenced in their favoured location adjacent to the entrance to the abbey church and fine construction of the grave slabs discovered in Trench 2. The occupants of these graves were possibly senior monks or benefactors from minor nobility, perhaps household members from the Douglasses of Dalkeith (Carrick 1907, 47) or the Crechtons (MacGibbon & Ross 1896, 253), who are known to have been generous patrons of the abbey.

The excavation defined points along the eastern and western boundaries of a cemetery

apparently beginning immediately north of the abbey church. By assuming some uniformity in the density of burials and that the excavation trenches ran near to the northern limit of the cemetery, a tentative calculation of the total population is possible. The 127 inhumations in Trenches 4 and 5 covered an area of 185m<sup>2</sup> with the cemetery apparently extending to at least 6825m<sup>2</sup> (105m east/west by 65m north/south). A rough estimation of the cemetery population is therefore approximately 4500–5000 individuals, an average of about 11 burials a year during the life of the Abbey.

#### TRENCH 1 BUILDING

Interpretation of this building is problematic. With an internal length of 19.1m it is not insignificant in scale, but its relatively unrefined construction contrasts with the massive proportions and fine ashlar masonry of the claustral complex. It thus probably signifies either an early building or one with a utilitarian function. In this respect it is similar to 'Room 12' at Jedburgh Abbey (Lewis & Ewart 1995, 145). With larger monasteries, assessing the uses of many buildings lying within the greater precinct but outside the cloister nucleus is difficult. Archive material indicating usage very rarely survives, and the very limited scope and number of modern archaeological investigations of Scottish monastic precincts has prevented compilation of meaningful data on the full suite of buildings and their uses (Fawcett 1996, 108). A further complicating factor is the variation in number, distribution and interrelationship of precinct buildings which could include residences, infirmaries, guest houses, offices, stores or agricultural buildings (Fawcett 2000, 96).

There are historical references to Newbattle possessing a '*poors infirmary*' (Dilworth 1995, 69). Gervase, the 19th abbot (demitted office 1323), settled the infirmary of the abbey 'an annual rent of three merks payable by William Byseth out of the lands of Merton, to

be expended for the uses of the sick and the recreation of the feeble' (Innes 1849). This institution explains, perhaps, the presence of the severely disabled individuals, Sk 571 and Sk 310, who were ultimately buried in the cemetery. Whether the Trench 1 building is actually that infirmary is impossible to say. In Cistercian abbeys where remains of a monks' infirmary survive, the building is part of the western claustral range, as at Melrose (RCAHMS 1956, 265–91, no 567). At Melrose however, claustral layout is reversed from the norm with the abbey church lying in the south. At Byland Abbey, Yorkshire, which can be seen as the architectural inspiration for Newbattle (Fawcett 2000, 47), the infirmary is a separate building to the south-east. Rievaulx Abbey has the infirmary again as a claustral building on the eastern side. On each occasion the infirmaries were near the water supply and drainage that was invariably the key factor in determining the layout of monastic buildings (ibid, 114). The position of the Newbattle building is contrary to the easy fulfilment of this need. However, there is a general rule that the infirmary hall was situated beyond the eastern range of the claustral nucleus and near the cemetery, as at Kelso Abbey (Tabraham 1984, 401).

During the excavation, trench location was determined by a desire to curtail ground disturbance (the minimum necessary to allow pipes to be lain) rather than answer fieldwork hypotheses. Whereas this excavation strategy served thus to maximize the in situ preservation of archaeological remains, both human skeletal material and the foundations of built structures, it frustrated the definitive answering of key questions such as the full scale, form and function of the Trench 1 building. Ultimately further work, such as geophysical reconnaissance, will be necessary in resolving the full character of this building and the remains of others that may survive within the abbey precinct. The probability of such survival is enhanced perhaps by significant depths of made ground occurring in locations within the

precinct, as found to the west of the abbey church in Trenches 2 and 4.

## RE-BURIAL

In discussions between AOC Archaeology Group and the client it was decided that the skeletal material should be re-interred following analysis. Historic Scotland agreed to this proposal and following a service at the College Chapel on 25th March 2003, all human remains were re-buried near their original resting place.

## ACKNOWLEDGEMENTS

AOC Archaeology Group would like to acknowledge the efforts of the excavation team members. All illustrations were drawn by Alan Hunter Blair.

Helen Bush would like to thank Gill Stroud for providing a 'second opinion' on a number of lesions and the Rev David Mungavin for commenting on the reversed orientation in the burial of priests.

AOC Archaeology Group thanks M J Gleeson Group plc and Stirling Water plc for generous assistance during the archaeological works. The principal of Newbattle Abbey College kindly permitted the re-burial of the remains within the College grounds and provided the College chapel for the re-interment service. Thanks are also due to Nick Bridgland of Historic Scotland for advice rendered during the course of the excavation.

## REFERENCES

- Bachmann, H G 1982 *The Identification of Slags from Archaeological Sites*. London (=Inst Archaeol Univ London Occ Pap, 6).
- Barrow, G W S 1973 *The Kingdom of the Scots*. London.
- Bowler, D & Hall, D 1995 'Kinnoull Street', in Bowler, D, Cox, A & Smith, C (eds), 'Four Excavations in Perth', *Proc Soc Antiq Scot*, 125, 939–47.
- Brothwell, D R 1981 *Digging Up Bones*. London.
- Brown, G & Roberts, J A 2000 'Excavations in the medieval cemetery at the city churches, Dundee', *Tayside & Fife Archaeol J*, 6, 70–86.
- Butler, L & Given-Wilson, C 1979 *Medieval Monasteries of Great Britain*. London.



- Burgess, J 1988 *The Monasteries of Southern Scotland*. Carlisle.
- Bush, H M 1989 *The Recognition of Physiological Stress in Human Skeletal Material: a critique of method and theory with specific reference to the vertebral column*. PhD thesis, Univ Sheffield.
- Carrick, J C 1903 'Churchyard Monuments at Newbattle', *Proc Soc Antiq Scot*, 37, 258–70.
- Carrick, J C 1907 *The Abbey of St Mary Newbottle: A Memorial of the Royal Visit*. Edinburgh.
- Coppack, G 2000 *The White Monks. The Cistercians in Britain*. Stroud.
- Cowan, I B & Easson, D E 1976 *Medieval Religious Houses Scotland with an Appendix on the Houses in the Isle of Man*. London.
- Cross, J F & Bruce, M F 1989 'The Skeletal Remains', in Stones, J A (ed) *Three Scottish Carmelite Friaries: Aberdeen, Linlithgow and Perth*, 119–142. Edinburgh (=Soc of Antiq of Scot Monogr 6).
- Cruden, S 1960 *Scottish Abbeys: An Introduction to the Medieval Abbeys and Priors of Scotland*. Edinburgh.
- Duncan, A A M 2000 *Scotland: The Making of the Kingdom*. The Edinburgh History of Scotland, Vol 1. Edinburgh.
- Eames, E 1980 *Catalogue of Medieval Lead-Glazed Earthenware Tiles*. London.
- Dilworth, M 1995 *Scottish Monasteries in the Late Middle Ages*. Edinburgh.
- Fawcett, R 1994 *The Architectural History of Scotland: Scottish Architecture from the Accession of the Stewarts to the Reformation 1371–1560*. Edinburgh.
- Fawcett, R 2000 *Scottish Abbeys and Priors*. London.
- Fenwick, M 1978 *Scotland's Abbeys and Cathedrals*. London.
- Goodall, I 1990 'Locks & Keys', in Biddle, M (ed) *Object and Economy in Medieval Winchester, 1000–5*. Oxford.
- Haggarty, G 1980 'The pottery', in Ewart, G 'Excavations at Stirling Castle 1977–78', *Post-Med Archaeol*, 14, 36–46.
- Haggarty, G 1984 'Observations on the ceramic material from phase 1 pits BY and AQ', in Tabraham, C 'Excavations at Kelso Abbey', *Proc Soc Antiq Scot*, 114, 395–7.
- Hall, D W 1997 'The Pottery', in Rains, M J & Hall, D W (eds), *Excavations in St Andrews 1980–89: A decade of archaeology in a historic Scottish Burgh*, 40–63. Glenrothes (=Tay & Fife Arch Comm Monogr 1).
- Hillson, S 2000 'Dental pathology', in Katzenberg, M & Saunders, S (eds) *Biological Anthropology of the Human Skeleton*. New York.
- Innes, C 1849 *Registrum Sancte Marie de Newbottle 1140–1528*. Edinburgh (=Bannatyne Club).
- Johnston, J B 1970 *Place-Names of Scotland*. Wakefield.
- Lewis, J & Ewart, G 1995 *Jedburgh Abbey: the archaeology and architecture of a border abbey*. Edinburgh (=Soc Antiq Scot Monogr Ser 10).
- London Museum, 1940 *Medieval Catalogue*. Suffolk.
- Long, A & Long, E 1983 'Nails', in Mayes, P & Butler, L (eds) *Sandal Castle Excavations 1964–1973*, 279–80. Wakefield.
- Kelley, M A & Micozzi, M S 1984 'Rib lesions in chronic pulmonary tuberculosis', *Am J Phys Anthropol*, 65, 381–6.
- Knight, K 1999 *The Catholic Encyclopedia*, Vol 20. Online edition.
- Lanier, R R 1954 'Some factors to be considered in the study of lumbosacral fusion', *Am J Phy Anthropol*, 12, 363–71.
- MacGibbon, D & Ross, T 1896 *The Ecclesiastical Architecture of Scotland: From the earliest Christian Times to the Seventeenth Century*. Edinburgh.
- Manchester, K 1983 *The Archaeology of Disease*. Bradford.
- Manning, W H 1985 *Catalogue of the Romano-British Iron Tools, Fittings and Weapons in the British Museum*. London.
- McDonnell, G 1986 *The Classification of Early Iron-working Slags*. Unpubl PhD thesis, Aston Univ.
- Molleson, T & Cox, M 1993 *The Spitalfields Project, Vol 2: the anthropology. The Middling Sort*. York (=CBA Research Report 86).
- Noel, M J & Newton, A C 2000 *Esk Valley Purification Scheme Geophysical Surveys within the Newbattle Abbey Annexe, Dalkeith*. Geoquest Associates, Consett.
- Oram, R 1998 'Prayer, property, and profit: Scottish monasteries, c1100–c1300', in S Foster, A Macinnes & R Macinnes (eds) *Scottish Power Centres from the Early Middle Ages to the Twentieth Century*, 00–00. Glasgow.
- Photos-Jones, E & Atkinson, J A 1998 'Iron-working in medieval Perth: a case of town and country', *Proc Soc Antiq Scot*, 128, 887–904.
- Rahtz, P 1978 'Grave orientation', *Archaeo J*, 135, 1–14.

- RCAHMS, 1929 *The Royal Commission on the Ancient and Historical Monuments and Constructions of Scotland. Tenth report with inventory of monuments and constructions in the counties of Midlothian and West Lothian*. Edinburgh.
- RCAHMS, 1956 *The Royal Commission on the Ancient and Historical Monuments of Scotland. An inventory of the ancient and historical monuments of Roxburghshire: with the fourteenth report of the Commission*, 2v, Edinburgh.
- Roberts, C & Manchester, K 1995 *The Archaeology of Disease*. 2nd edn, Ithaca.
- Rogers, J & Waldron, T 1995 *A Field Guide to Joint Disease in Archaeology*. Chichester.
- Salter, C 1991 'Metallurgical aspects of the iron-working debris', in Cunliffe, B (ed), *Danebury: An Iron Age hillfort in Hampshire*, 412–15. Oxford (=Counc Brit Archaeol Res Rep, 73).
- Schmorl, G & Junghanns, H 1991 *The Human Spine in Health and Disease*. Besemann, E F (transl & ed), 2nd American edn. New York.
- SDD 1964 *List of Buildings of Architectural or Historical Interest*. SDD, 4, no 9.
- Smith, R 2001 *The Making of Scotland*. Edinburgh.
- Spearman, R M 1997 'The Smithy and metalworking debris from Mills Mount', in Driscoll, S T & Yeoman, P A (eds) *Excavations within Edinburgh Castle*, 164–8. Edinburgh (=Soc Antiq Scot Monogr Ser, 12).
- Stroud, G 1993 'The human bones', in Stroud, G & Kemp, R L (eds) *Cemeteries of the Church and Priory of St Andrew, Fishergate. The Archaeology of York Vol. 12: The Medieval Cemeteries*, 159–285. York.
- Stuart-Macadam, P 1982 *A Correlative Study of a Palaeopathology of the Skull*. Unpubl PhD thesis, Univ Cambridge.
- Stuart-Macadam, P 1985 'Porotic hyperostosis: representative of a childhood condition', *Am J Phys Anthropol*, 66, 391–8.
- Stuart-Macadam, P 1986 *Porotic hyperostosis: relationship between orbital and vault lesions*. Paper presented at VI Meeting of European Palaeopathology, Madrid.
- Tabraham, C J 1984 'Excavations at Kelso Abbey', *Proc Soc Antiq Scot*, 114, 365–404.
- The Chronicle of Melrose*. Stevenson, J (trans) 1991 Facsimile imprint, Lampeter.
- Wells, C 1982 'The Human Burials', in McWhirr, A, Viner, L & Wells, C (eds) *Romano-British Cemeteries at Cirencester*, 135–201. Cirencester.
- Wordsworth, J & Clark, P R 1997 'Kirkhill', in Rains, M J & Hall, D W (eds), *Excavations in St Andrews 1980–89: A decade of archaeology in a historic Scottish Burgh*, 7–16. Glenrothes (=Tay & Fife Arch Comm Monogr 1).

*This paper is published with the aid of a grant from M J Gleeson Group plc and Stirling Water plc.*

