

Fig. 6.10. Examples of D-shaped enclosures

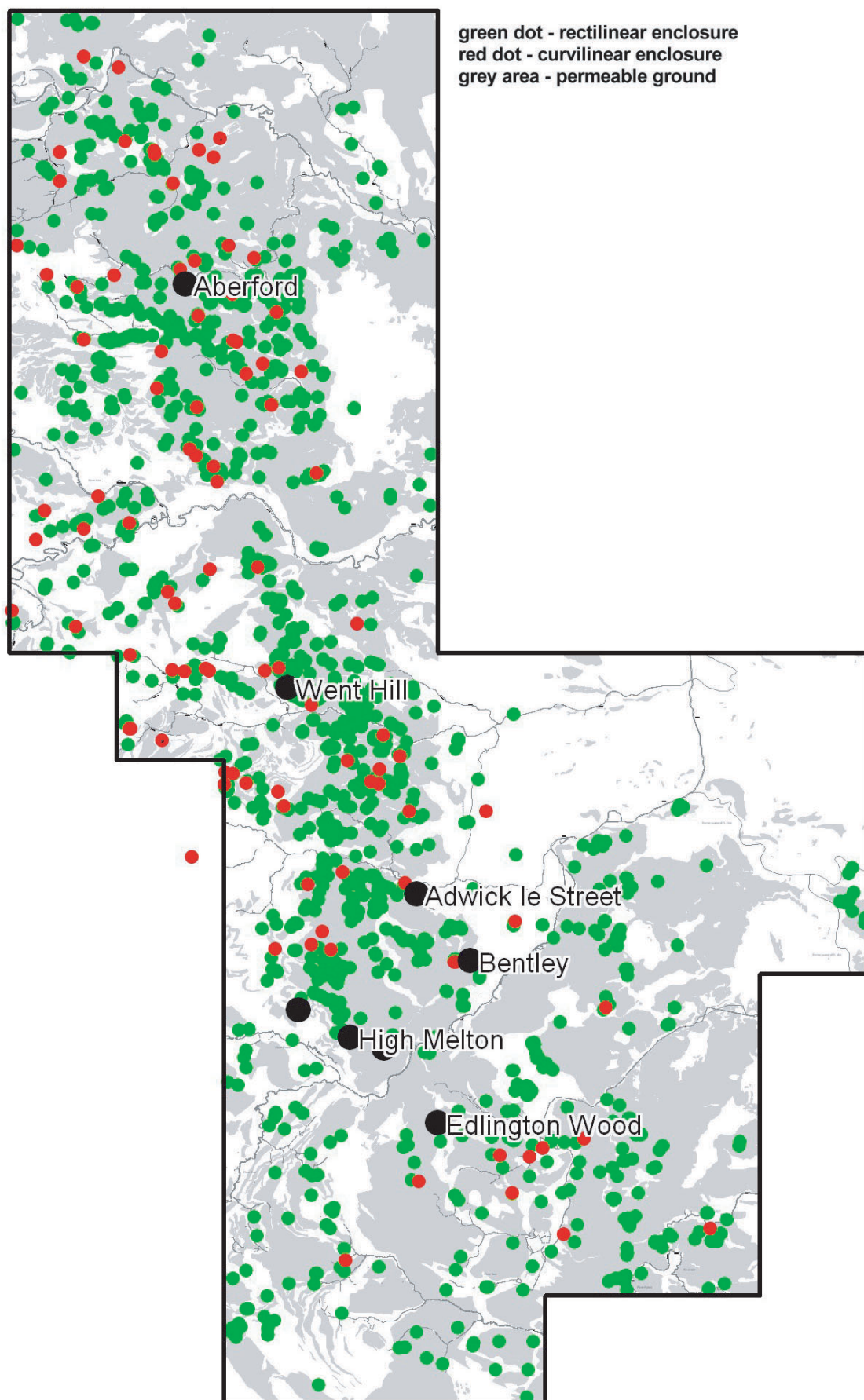

Fig. 6.11. Distribution of rectilinear and curvilinear enclosures

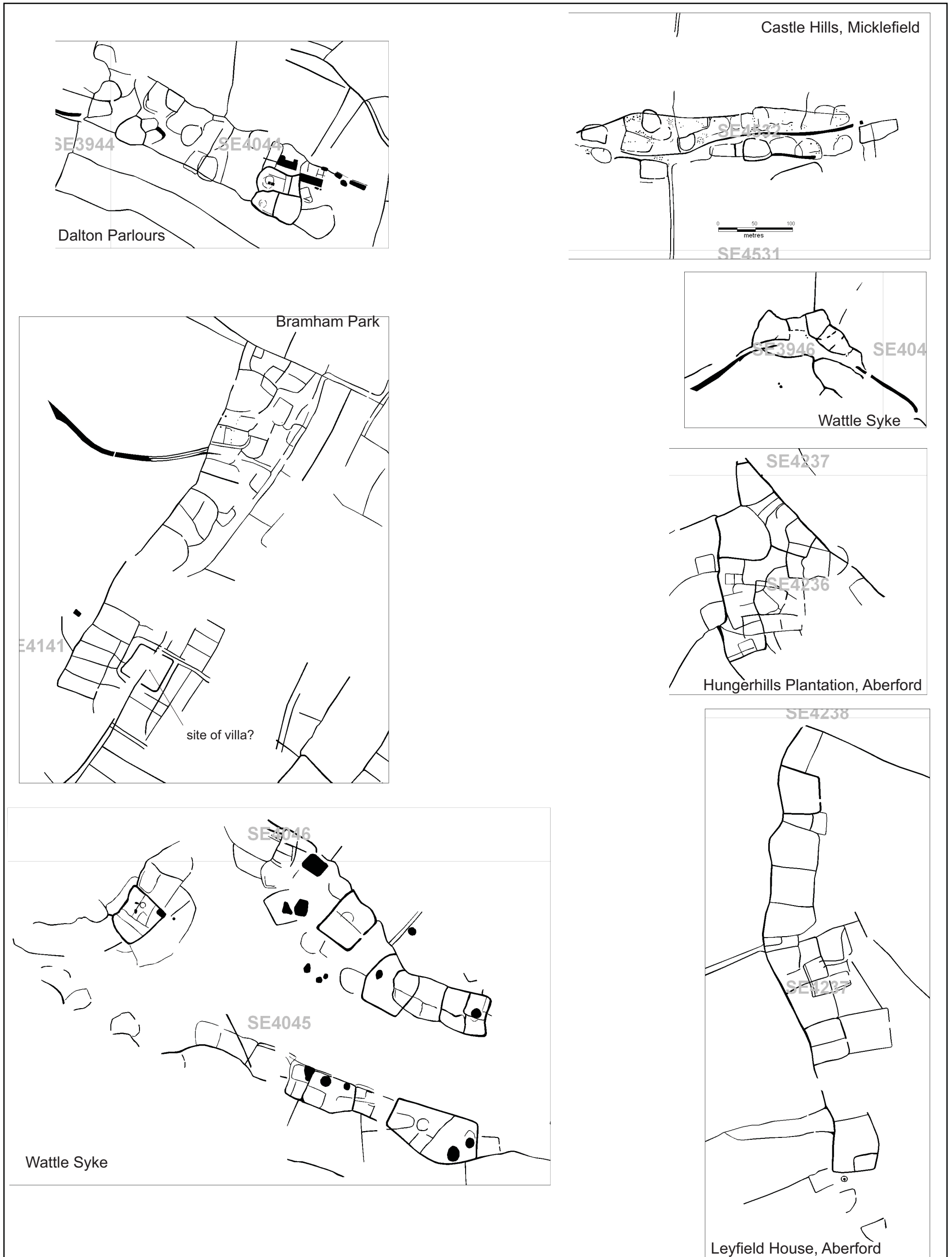

Fig. 6.12. Examples of extensive enclosure groups



Fig. 6.13. Examples of enclosures with trackway entrances



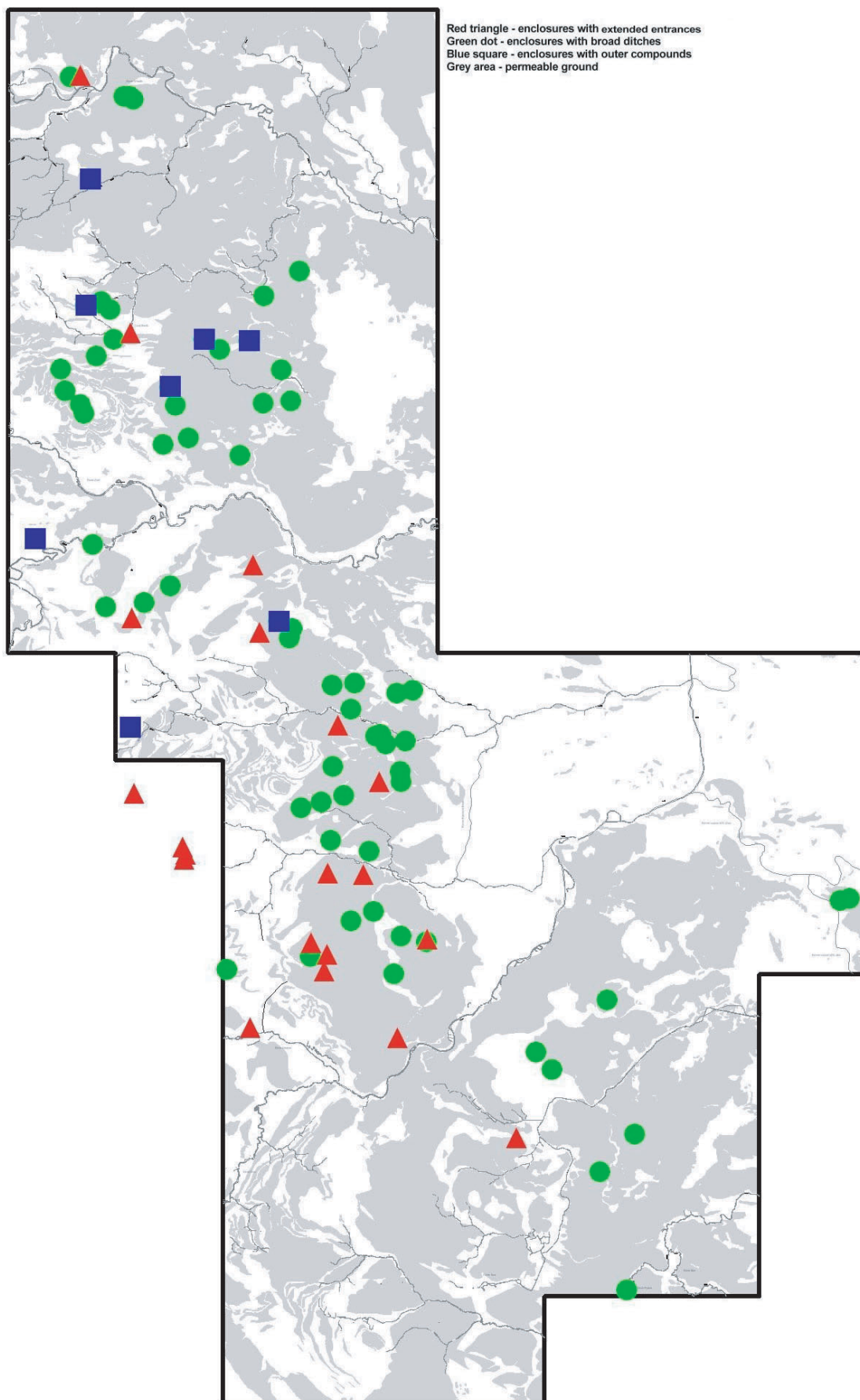

Fig. 6.14. Distribution of different types of enclosures

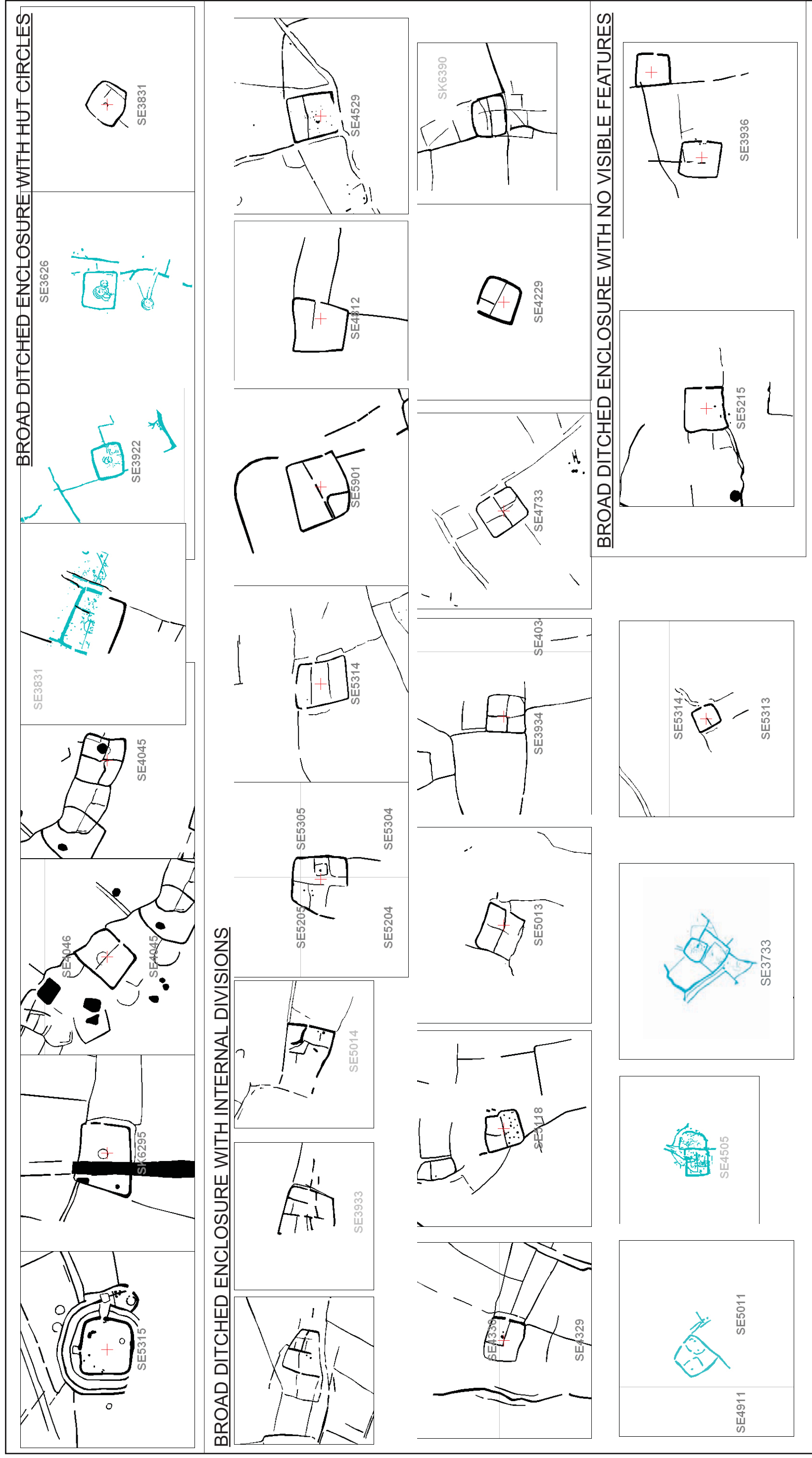

Fig. 6. 15. Examples of broad-ditched enclosures

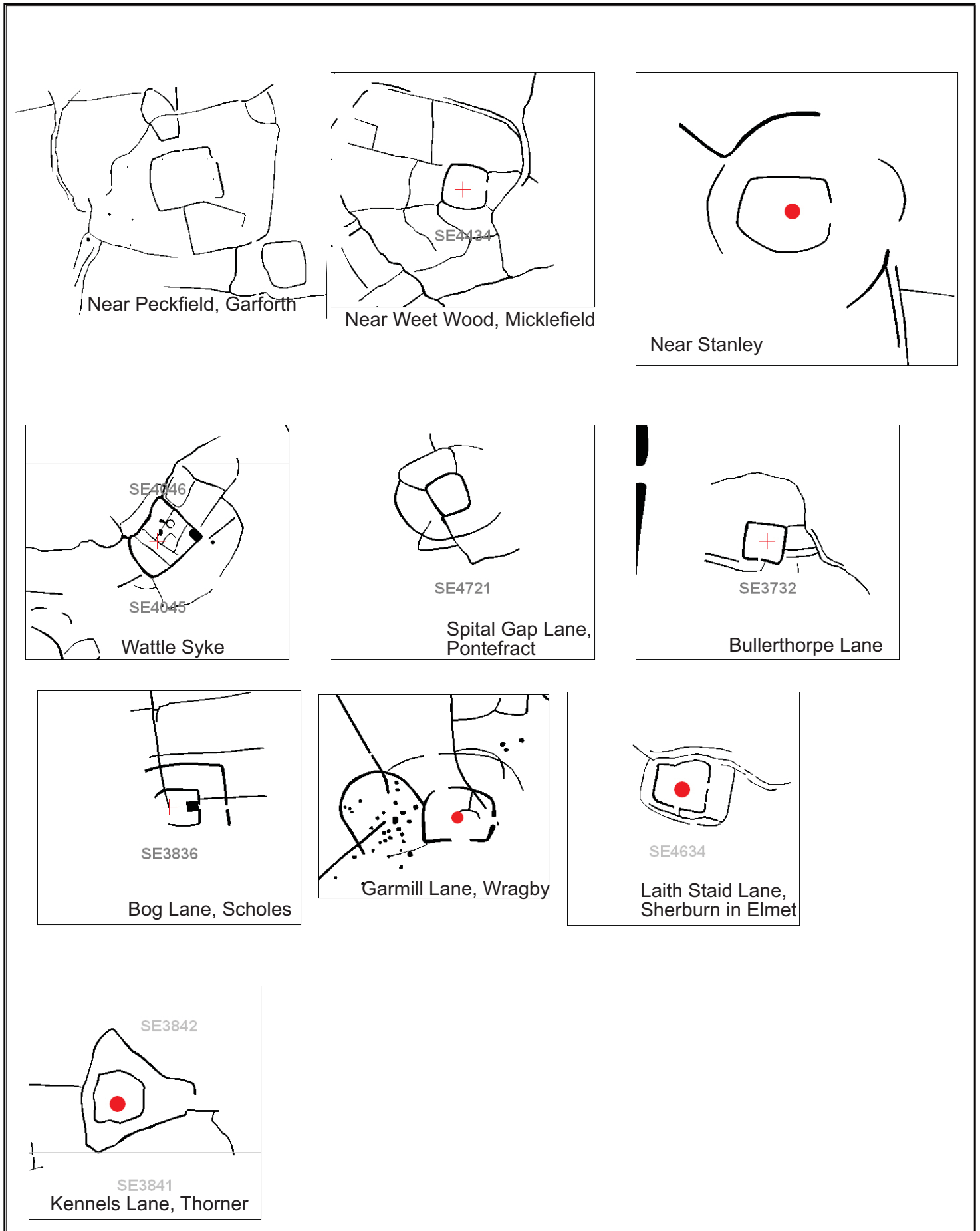
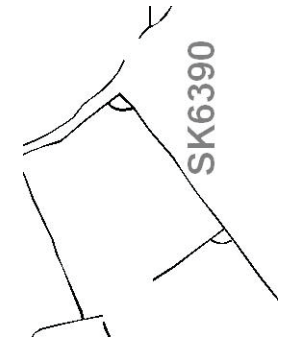
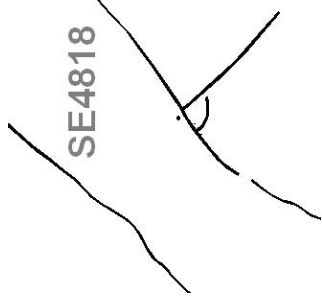

Fig. 6.16. Examples of enclosures with outer compounds

SIMPLE FIELD CORNER ENCLOSURES



Ruins Plantation, Harworth and Bircotes



Went Hill

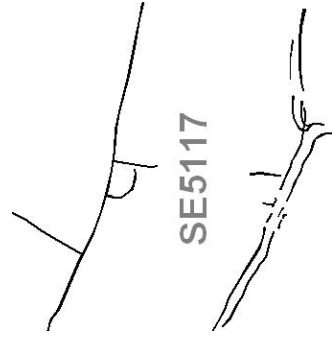

Kirk Smeaton



Ferrybridge (after Roberts 2005)

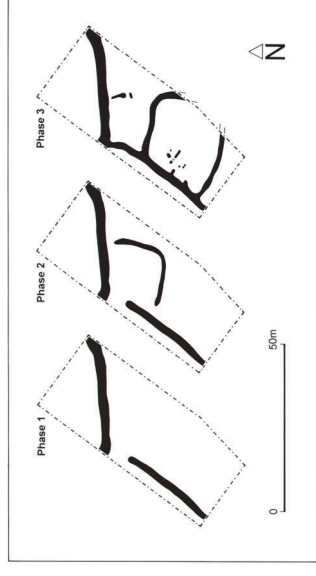

Dawson's Wood (after Roberts *et al.* 2001)

FIELD CORNER ENCLOSURES

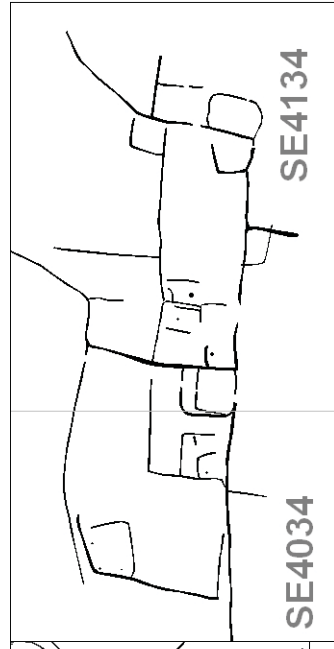
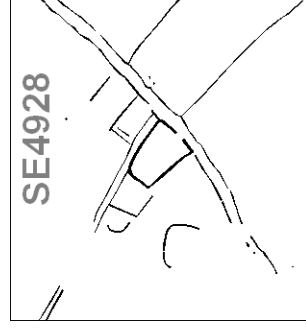
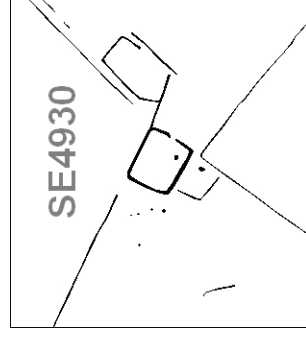
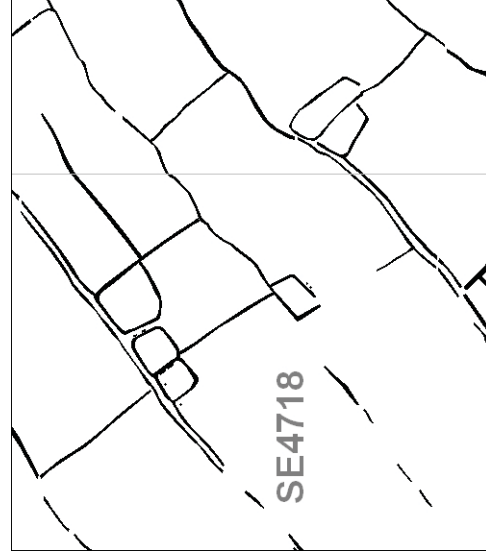
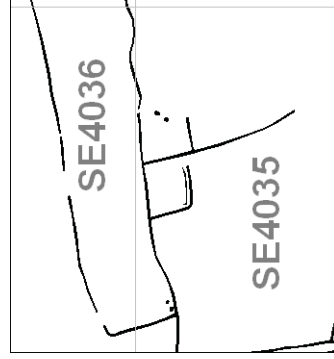
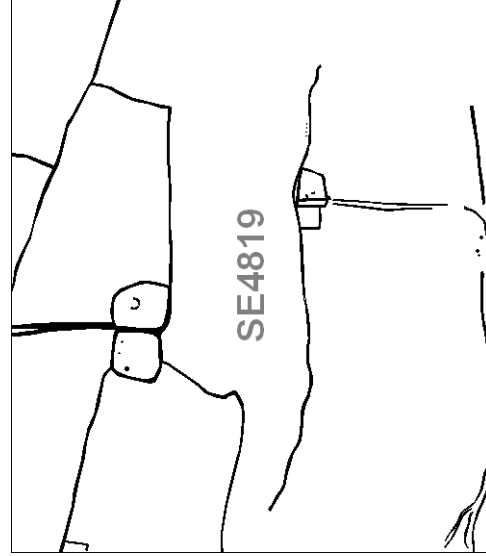
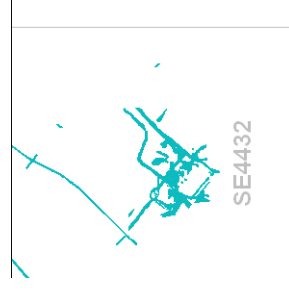
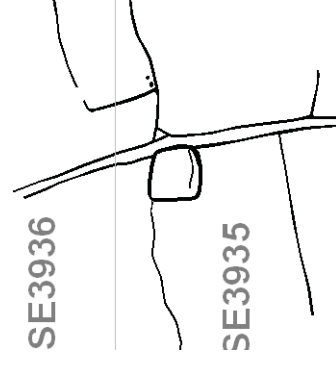
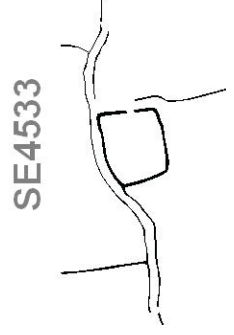
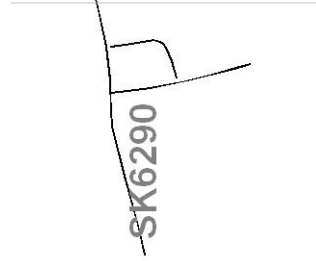
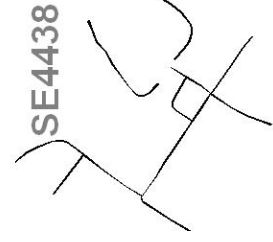
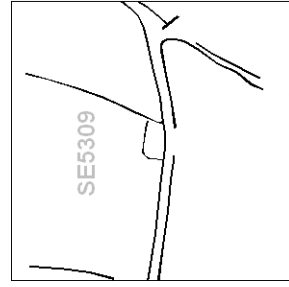
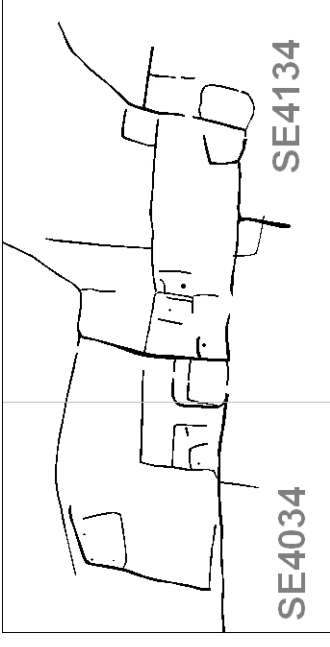
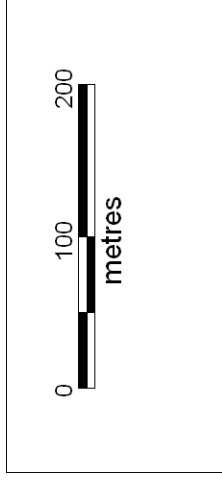
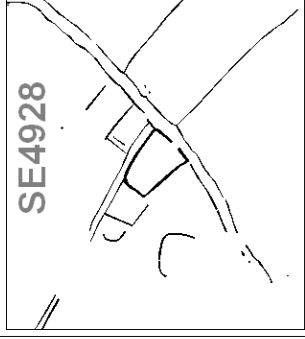
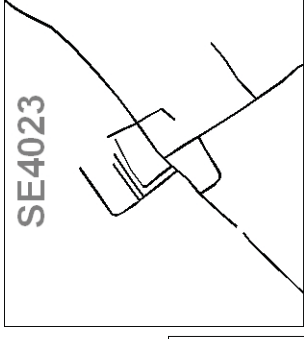
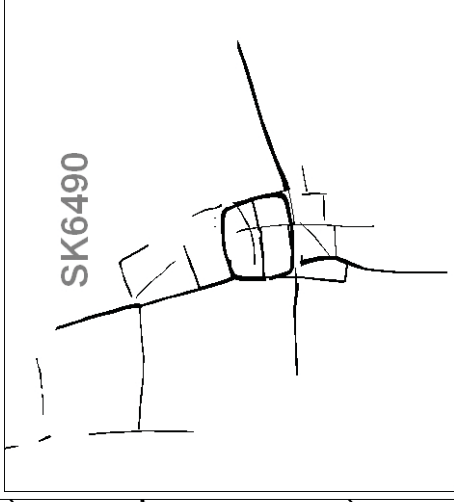
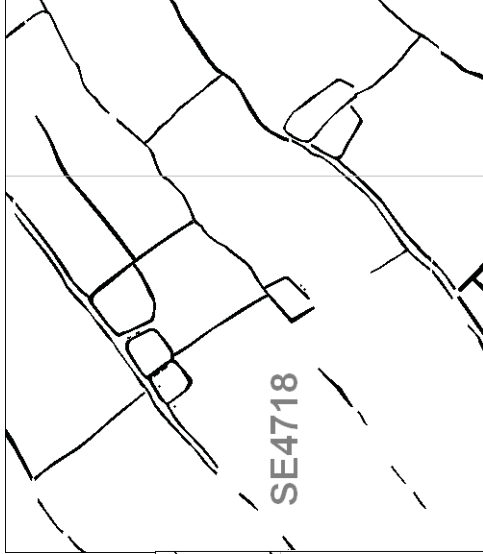
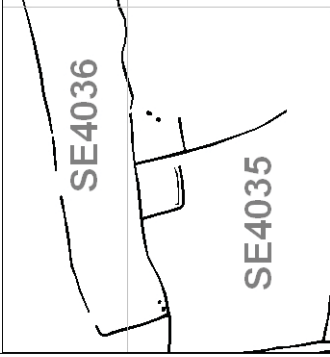
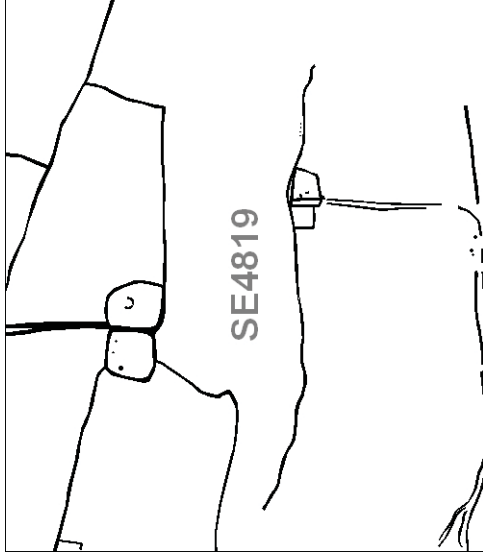

Fig. 6.17. Examples of field corner enclosures



Field corner enclosure groups



Context of field corner enclosures



Fig. 6.18. Contexts of field corner enclosures

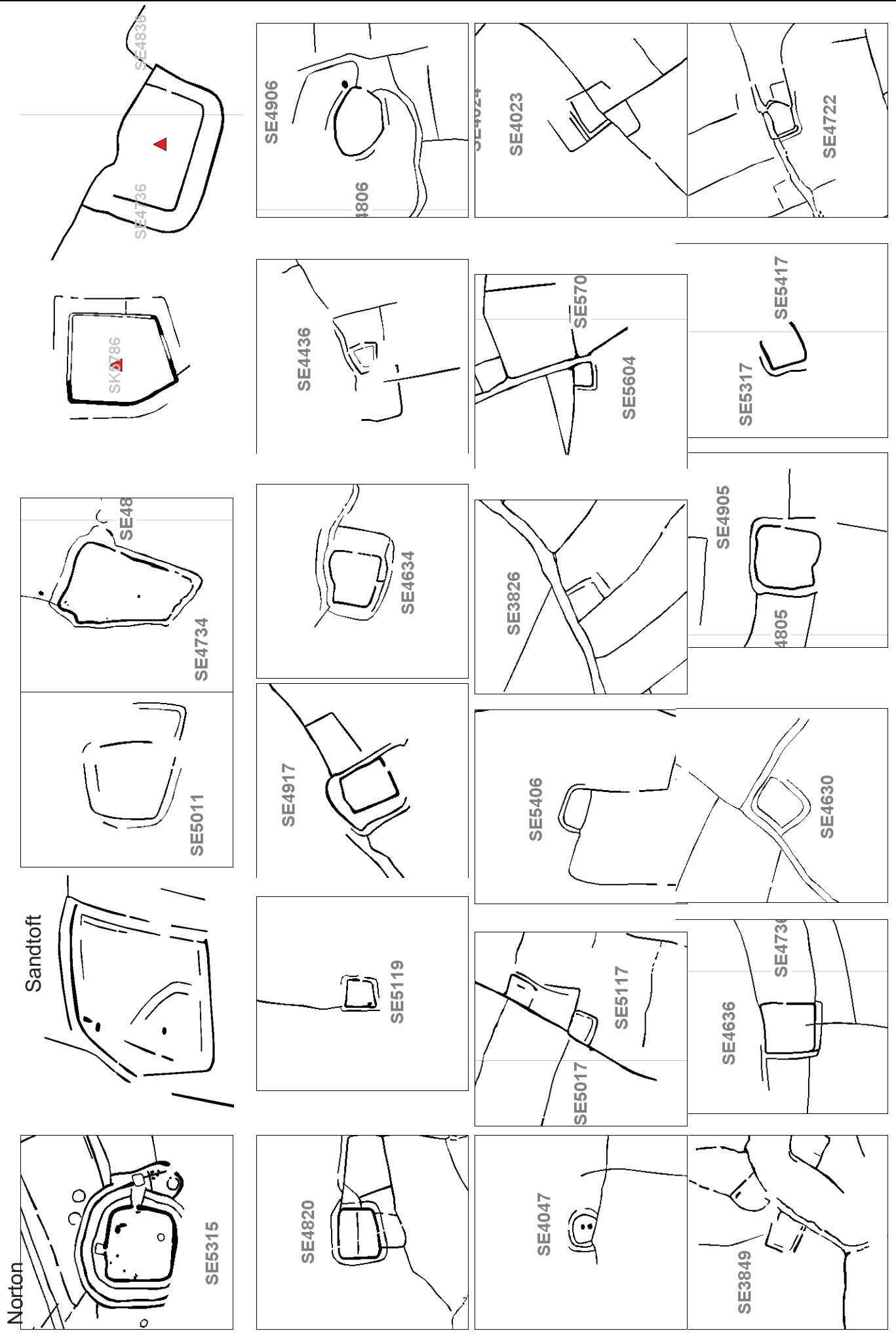

Fig. 6.19. Examples of enclosures with multiple circuits

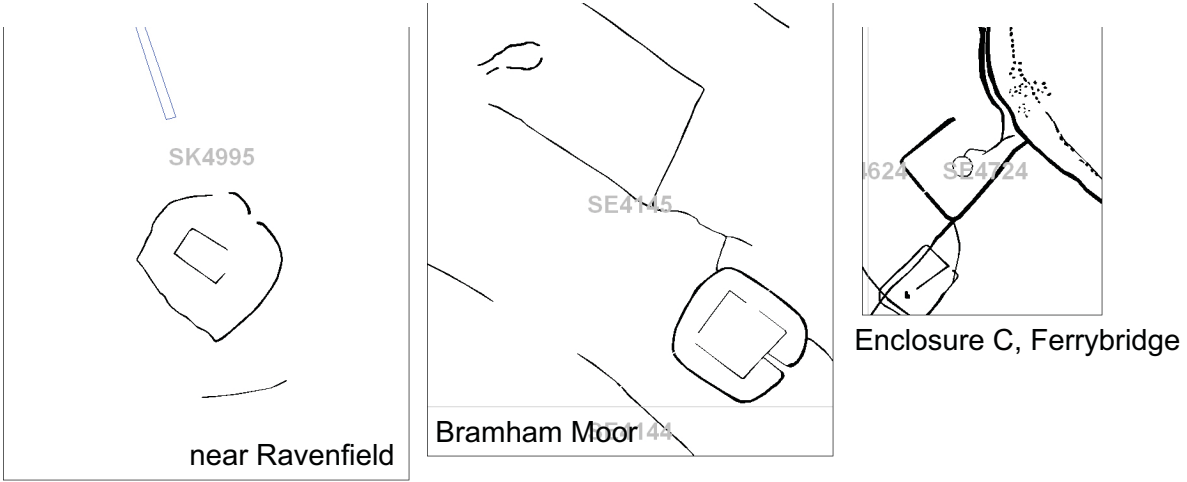

Fig. 6.20. Examples of possible shrines or ritual enclosures

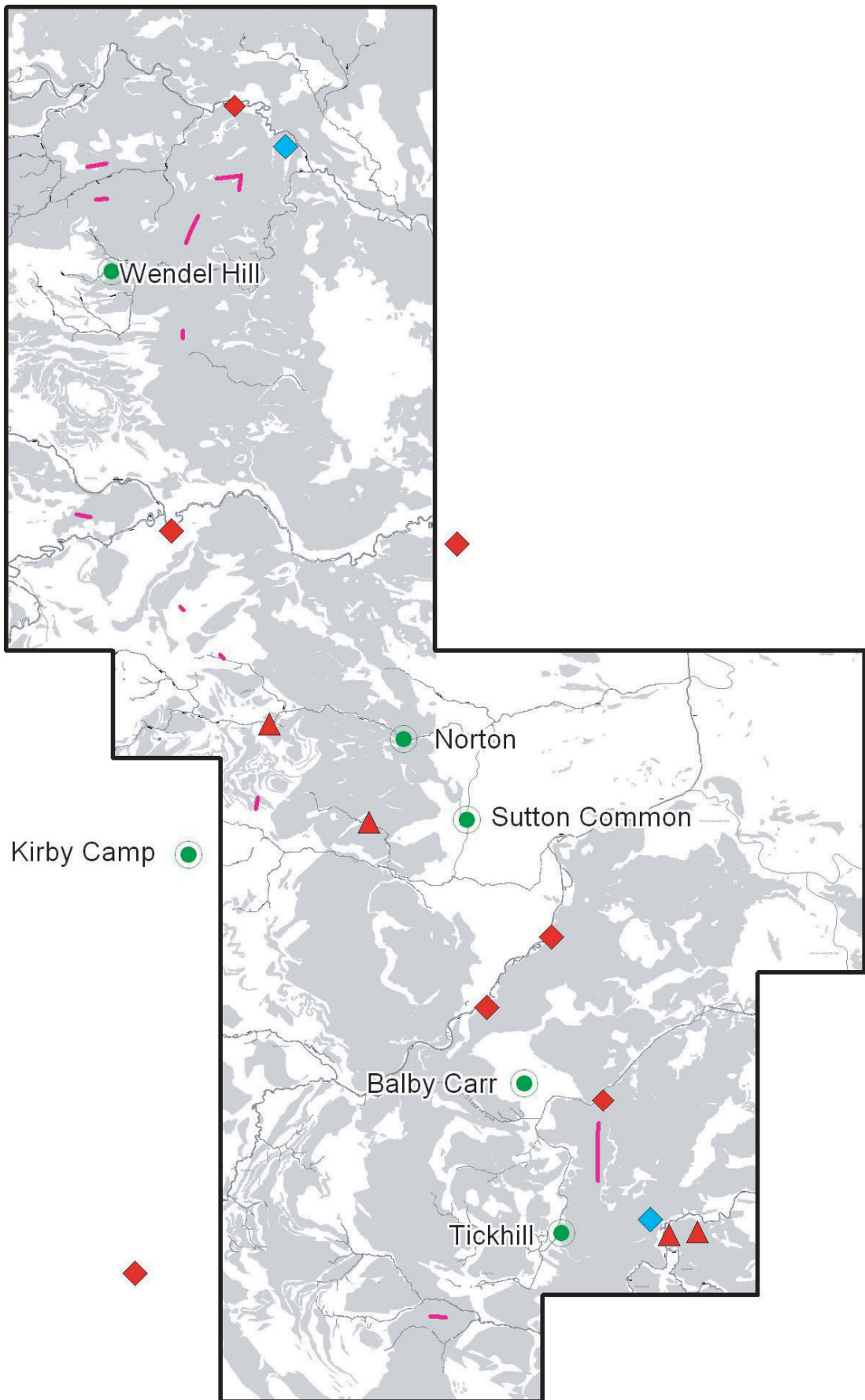

Fig. 6.21. Distribution of Iron Age forts, Roman forts and fortlets and Roman roads

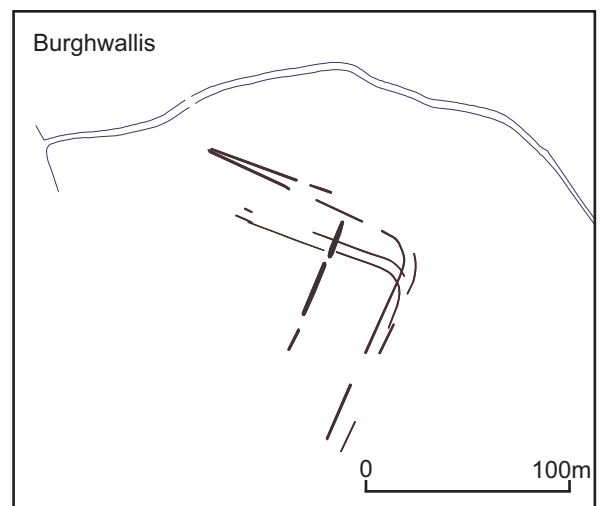
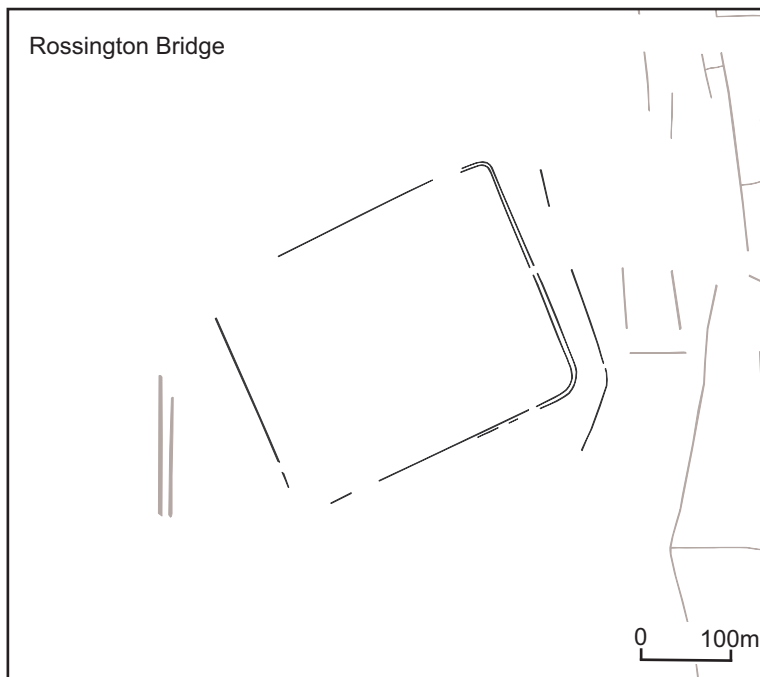
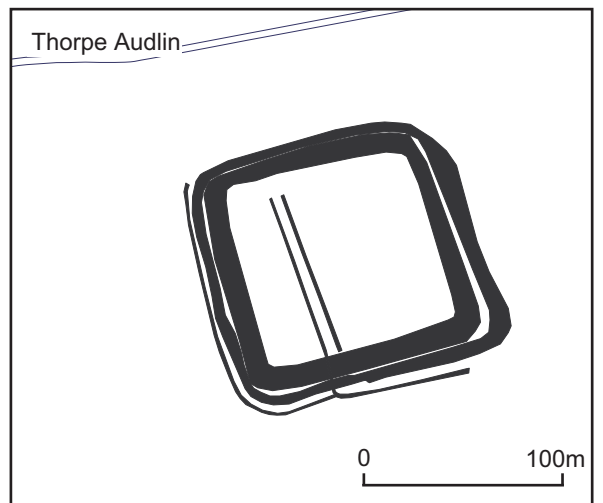
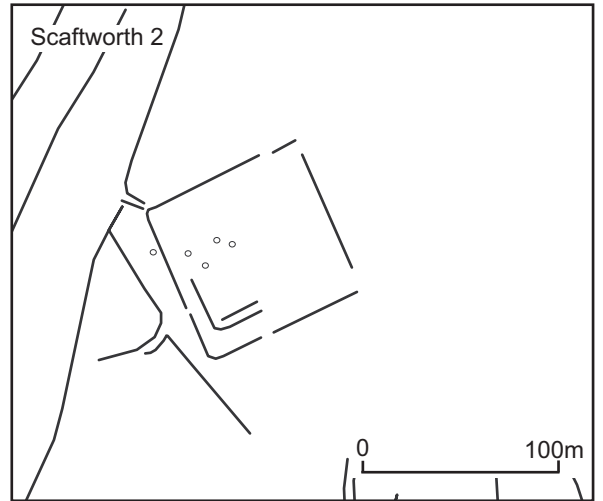
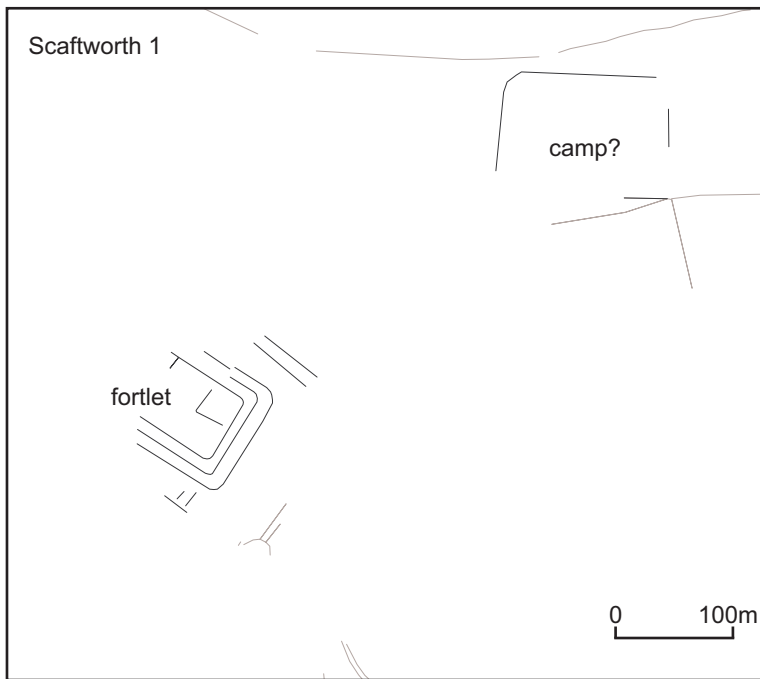
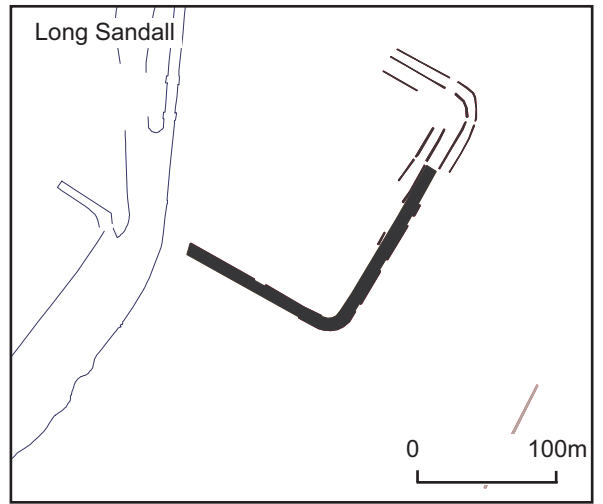
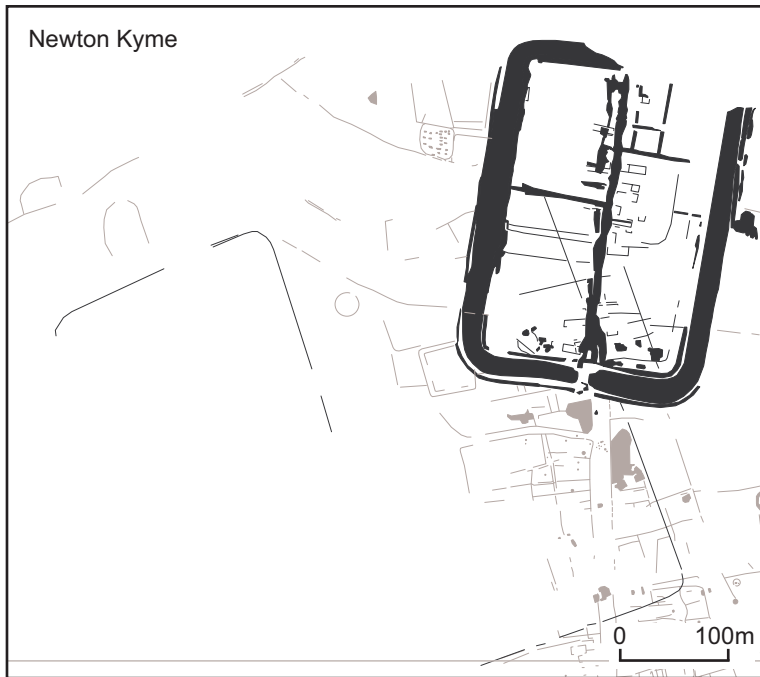

Figure. 6.22. Examples of Roman forts and fortlets