

FIG. 4.2 Site plan 1.

## INVENTORY

### PART 1: Deposits 2-100

#### 2 1967/114 UNPHASED

Plan FIG. 4.2; details FIG. 4.3.

**Description** Partial cist with sandstone slabs on NW and NE sides of square pit (0.42 x 0.45m; major axis N/S). Fill: light brown with general scatter of bone and charcoal.

**Cremated human bone** Adult (21–30 years); unsexed. Wt. 57.3g (including 0.4g worked bone).

#### Pyre goods

1 Bone veneer types: A4.1; F.

#### Finds of uncertain status

2 B01. Wt. 1g. RE 7 (BC/IB). A BB1 jar rim fragment. Hadrianic to mid fourth-century.

**Interpretation** Redeposited pyre debris.

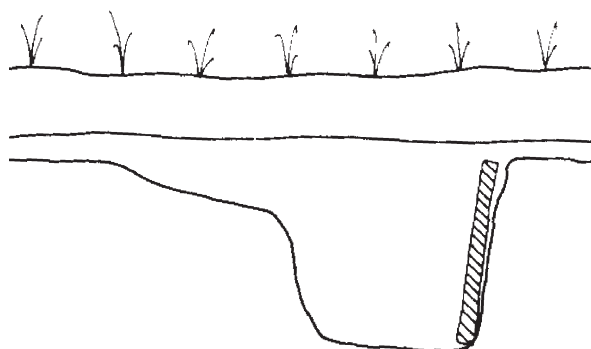
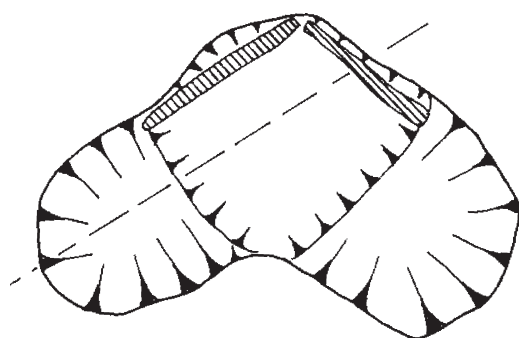

FIG. 4.3 Plan and section of pyre debris deposit 2.

#### 3 1967/123 UNPHASED

Plan FIG. 4.2; details FIG. 4.4.

**Description** Square pit (0.76 x 0.72m; major axis NW/SE). Fill: brown with concentrated deposits

of bone and/or charcoal especially in lower part of pit and towards western corner.

**Cremated human bone** Two groups, original location unknown.

(i) Adult (18–100 years); unsexed. Wt. 45g (including 0.6g worked bone).

(ii) Adult (18–22 years); female?? Wt. 30.9g (including 1.1g worked bone).

Iron fused to long bone; bone charcoal-stained.

**Charcoal** *Alnus* sp. (xxx).

*Fraxinus* sp. (xx).

*Betula* sp. (x).

#### Pyre goods

1 Copper alloy; bell-shaped stud distorted by heat. Diameter 25mm.

2\* Copper alloy; vessel, rim fragments (3).

3 Copper alloy; sheet; nine fragments; 13 fragments distorted by heat; droplets (3).

4 Lead alloy; fragment.

5 Iron; hobnails (7 + 1 from cremation).

6 Iron; nail (39, including 6 fragments).

7 Bone veneer types: A1.1; A2.1; A5.1; A5.2; A5.5; B1.1.

#### Finds of uncertain status

8 ?R01. Wt. 2g (BC/IJ). A greyware bodysherd from a closed form.

9 ?R08. Wt. 10g (BC/IJ). Two greyware bodysherds from the neck of a constricted-necked jar or flagon.

10 B01. Wt. 1g. (BC/IJ). Two fragments from the rim edge of a BB1 jar, sooted. Later second to third-century. Also six BB1 jar shoulder bodysherds and one burnt bodysherd from a jar with obtuse lattice decoration. Third to mid fourth-century.

**Interpretation** Redeposited pyre debris.

#### 4 1967/209 UNPHASED

Plan FIG. 4.2; details FIG. 4.5.

**Description** Oval pit with shallow sloping sides (0.5 x 0.32m; major axis NE/SW). Fill: light brown with concentrations of cremation debris throughout. Probably truncated by plough or machine.

**Cremated human bone** Subadult–adult (13–100 years); unsexed. Wt. 9.4g (including 0.5g worked bone).

#### Pyre goods

1 Copper alloy; fragment (3).

2 Bone veneer type: E2.1.

**Interpretation** Redeposited pyre debris.

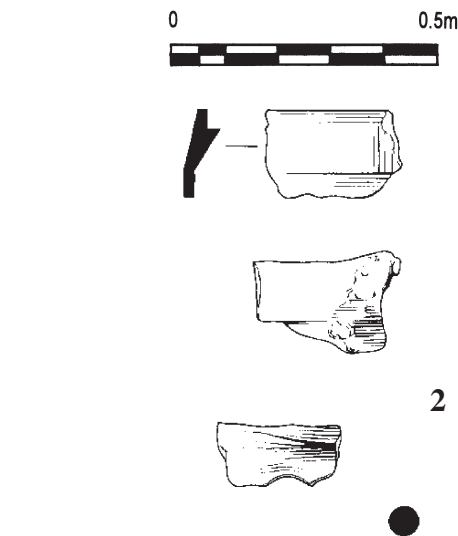
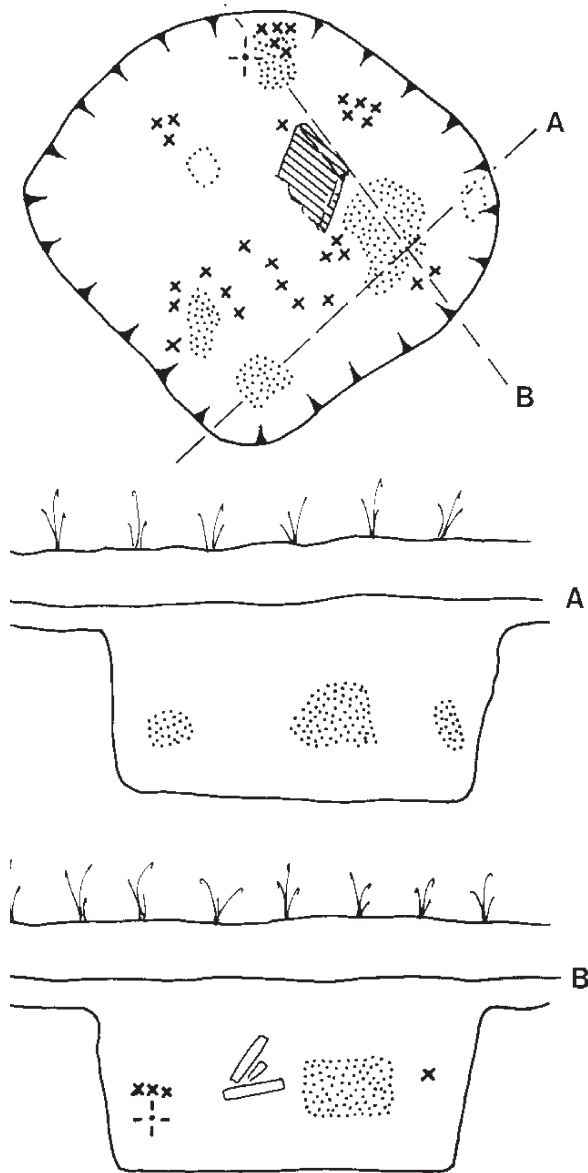

FIG. 4.4 Plan, section and finds from pyre debris deposit 3.

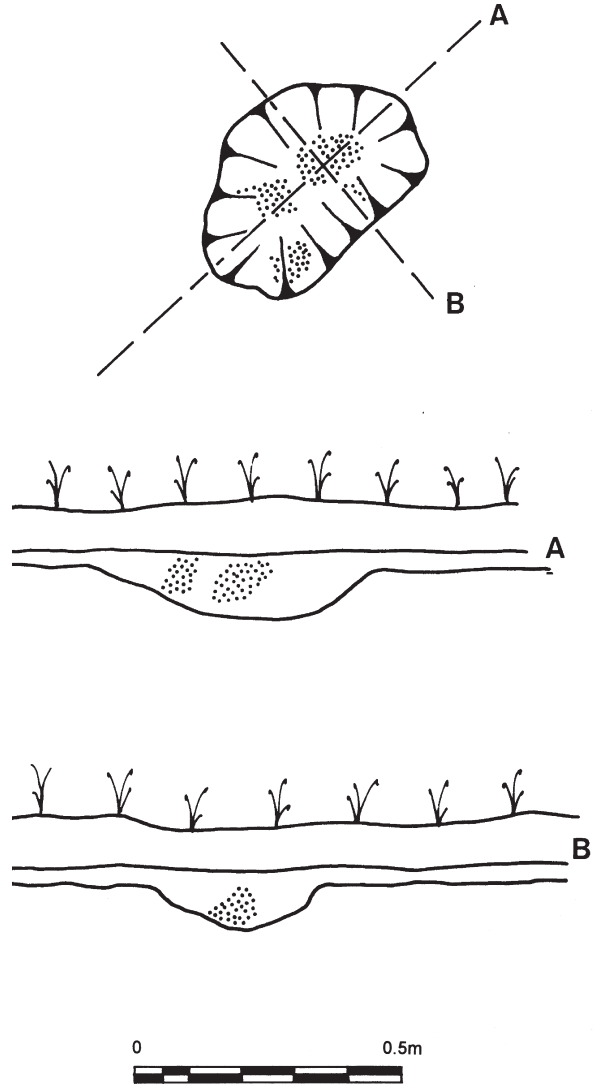

FIG. 4.5 Plan and section of pyre deposit 4.

5 1967/140 PHASE 2

Plan FIG. 4.2; details FIG. 4.6.

**Description** Crescentic pit with slight depression in base (0.51 x 0.42m; major axis N/S). Urned burial (in 4) may have been placed in depression. Fill: no description.

**Cremated human bone** Infant (3 years); unsexed. Wt. 6.8g (including glass fused to bone) 0.3g from outside vessel. Charcoal-stained.

**Charcoal** *Betula* sp. (\*) from jar (4).

**Pyre goods**

- 1 Iron; fragment (4).
- 2 Iron; nail, two from cinerary urn.
- 3 Glass; vessel. Blue/green heat-affected body fragment from cremated bone. Other fragments recorded inside jar (4) during excavation but not now extant.

**Grave goods**

- 4\* B01. Wt. 195g. RE 22, BE 71 (BC/JF).

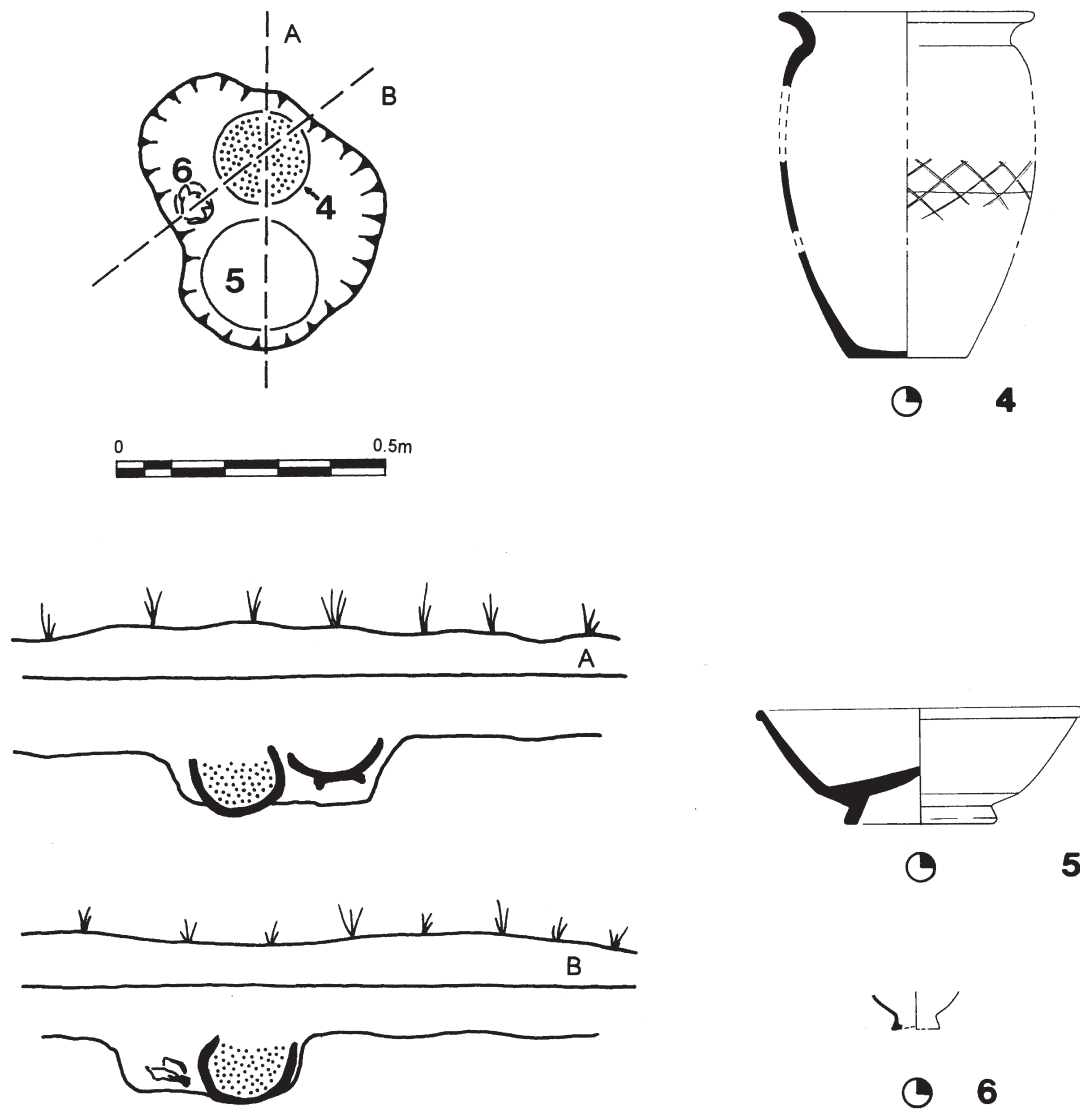

FIG. 4.6 Plan, section and grave goods from urned cremation burial 5.

Fragments from a BB1 jar with everted rim, sooted, with obtuse lattice decoration. Two rimsherds and a shoulder sherd are burnt. Cf. Gillam (1976) nos 7–9, third century. c. A.D. 200/220–300.

5\* S20. Wt. 375g. RE 85, BE 100 (BC/JH). Ten fragments giving a complete form 31 Central Gaulish, with Pudding Pan Rock proportions, stamped MASIILLIO by Mascellio i (Die 4a). The footring is probably worn as well as weathered. Mascellio i worked at Lezoux and stamps from this die occur at Bainbridge, Binchester, Birdoswald, Catterick, Lanchester, Piercebridge and Pudding Pan Rock. c. A.D. 170–200.

6\* S30. Wt. 24g. RE 100, BE 100 (BC/JG). Many fragments of a thin-walled jar with bunge-shaped foot, probably East Gaulish samian rather than colour-coated ware. A hole has

been knocked through the base and the vessel has been in contact with soot. It is not clear whether this is an example of 'killing' of the pot, or whether it had been altered for use as a funnel. Late second or third-century.

#### Finds of uncertain status

7 S30. Wt. 15g. RE 15 (BC/JH). Four rim fragments, probably all from the same form 31R. East Gaulish. Late second or third-century.

**Interpretation** Urned cremation burial.

6 1967/214 PHASE 3B

Plan FIG. 4.2.

**Description** Sub-circular pit, straight-sided in upper part, base sloping shallowly into centre

(diameter *c.* 0.65m). Fill: concentrations of bone, charcoal and pyre goods throughout.

**Cremated human bone** Subadult–adult (13–100 years); unsexed. Wt. 8.2g.

**Charcoal** *Betula* sp. (xx).  
*cf. Quercus* sp. (x).

#### Pyre goods

- 1 Copper alloy; nail. D. 6mm.
- 2 Copper alloy; fragment distorted by heat; sheet fragment.
- 3 Iron; hobnail (41).
- 4 Iron; nail (20 including 12 fragments).
- 5 Glass; vessel. Blue/green, 21 melted body fragments, lump (35g).
- 6 Glass; bead. Broken fragment from melted lump. Cloudy emerald green fused with translucent deep blue.
- 7 S20. (BC/NC). A small, burnt fragment of uncertain form, apparently Central Gaulish. Antonine.
- 8 S30. (BC/NC). A fragment of form 37, slightly burnt, East Gaulish. Late second or third-century.
- 9 B01. Wt. 93g. RE 22, BE 13 (BC/NC). Eighteen sherds from a BB1 jar rim and shoulder and base fragments, all heavily burnt orange. *Cf.* Gillam (1976) types 8–9, mid to late third-century. ?*c.* A.D. 240–70.
- 10 B01. Wt. 42g. RE 8 (BC/NC). Two rim fragments from a simple-rimmed dish, interior and exterior burnished, both heavily burnt. Hadrianic to mid fourth-century.

#### Finds of uncertain status

- 11 F03. Wt. 13g. BE 33. A Nene Valley colour-coated ware beaker base and four bodysherds, probably from the same vessel. *c.* A.D. 160/70+.
- 12 M03. Wt. 48g. A mortarium bodysherd with slag trituration grits, slightly oxidised but probably Crambeck and *c.* A.D. 285+.
- 13 R06. Wt. 8g. BE 15 (BC/NC). A simple jar base.
- 14 B01. Wt. 22g. RE 15 (BC/NC). A BB1 jar rimsherd with everted rim, sooted. *Cf.* Gillam (1976) no. 8, mid third-century. *c.* A.D. 230–270.
- 15 R03. Wt. 10g. Two greyware bodysherds.
- 16 S20. (BC/NC). A fragment from the base of a flat dish in micaceous fabric, Central Gaulish. Antonine.

**Interpretation** Redeposited pyre debris.

#### 7 1967/195 PHASE 3B

Plan FIG. 4.2; details FIG. 4.7.

**Description** Sub-square pit with steep sides and flat base (0.67 x 0.55m; major axis W/E). Fill:

concentration of bone, charcoal and pyre goods in SW corner and vessels in northern part, though finds records note some cremated bone in bases of (6) and (7).

**Cremated human bone** Adult (35–100 years); unsexed. Wt. 167.2g (including 3.9g animal and 7.7g worked bone). Pathology: exo – iliac crest.

**Cremated animal bone** Large ungulate.

**Charcoal** Observed in cremated bone.

#### Pyre goods

- 1 Copper alloy; stud diameter 9mm, L. 14mm.
- 2 Copper alloy; sheet fragment.
- 3 Iron; nail (3) with cremated bone in base of pots (6–7).
- 4 Bone veneer types: A3.2; B2.4; E2.1.
- 5 Bone; fragment with drilled hole.

#### Grave goods

- 6\* W02. Wt. 700g. RE 35, BE 100 (BC/ML). A Nene Valley parchment ware face-necked flagon, largely complete except for part of the rim, with multiple-grooved lug handle, red painted and representing the hair, with a moulded face on the front, with red painted bands on the body. *Cf.* Howe *et al.* (1980) no. 96, fourth-century with a different hair style.
- 7\* F03. Wt. 160g. RE 100 (BC/MK). A rim and some bodysherds from a disc-rimmed flagon in Nene Valley colour-coated ware. Probably third to fourth-century.

**Interpretation** Probably unurned cremation burial with accessory vessels.

#### 8 1967/136 UNPHASED

Plan FIG. 4.2.

**Description** Oval pit with sloping sides and flat base (0.62 x 0.45m; major axis NW/SE). Fill: light brown with tip of cremated material described as ash in southern part. No material collected.

**Interpretation** Redeposited pyre debris.

#### 9 1967/134 PHASE 1

Plan FIG. 4.2; details FIG. 4.8.

**Description** Oval pit (0.69 x 0.48m; major axis N/S). Fill: light brown with urned cremation burial (5) and accessory (6) placed centrally. Truncated by ploughing or machine.

**Cremated human bone** Adult (18–100 years); unsexed. Wt. 38.6g (including 0.2g worked bone). Pathology: op – acetabulum.

#### Pyre goods

- 1 Copper alloy; fragment from (5).
- 2 Iron; fragment.

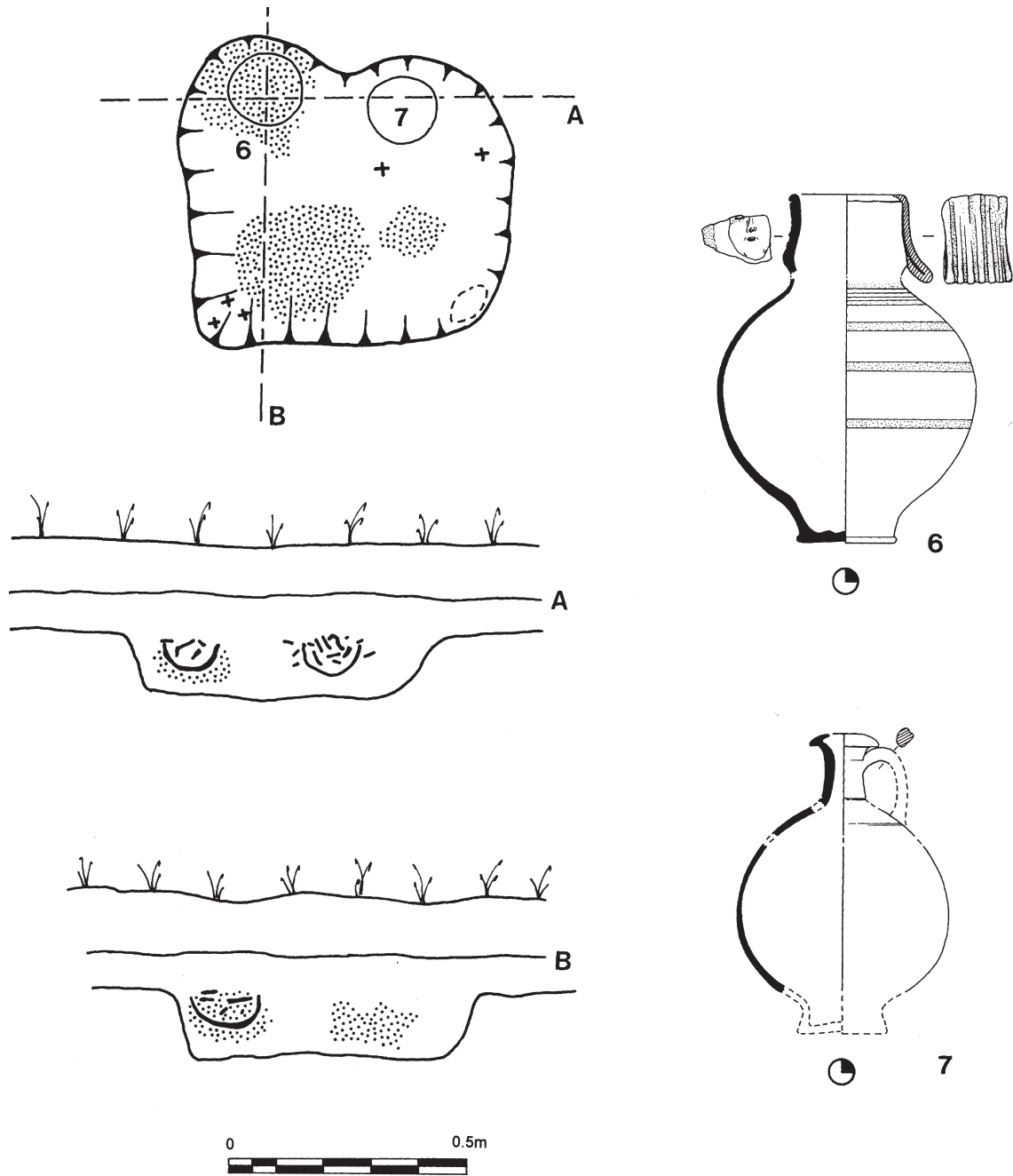

FIG. 4.7 Plan, section and grave goods from unurned cremation burial 7.

- 3 Iron; nail from (5).  
 4 Bone veneer type: E2.1.

#### Grave goods

- 5 B01. Wt. 400g. BE 34 (BC/IU). Eighty-five sherds from the lower wall and base of a BB1 jar, eight are burnt.  
 6\* S30. Wt. 575g. RE 56, BE 76 (BC/IT). A fragment of form 31 (Sb/Sh), East Gaulish (Trier), stamped VRSV VS[FE]. There is much erosion and wear on the footring and the inside is also weathered. For details of the stamp, see 255.3.

#### Finds of uncertain status

- 7 S20. Wt. 16g. RE 5 (BC/IT). Three small fragments of form 38, Central Gaulish, with an extraordinarily wide flange. (See 12.4 for the greater part of this bowl.) Late-Antonine.

**Interpretation** Urned cremation burial.

#### 10 1967/228 UNPHASED

Plan FIG. 4.2; details FIG. 4.9.

**Description** Sub-rectangular pit with sloping sides and flat base (0.5x 0.46m; major axis N/S). Fill: light

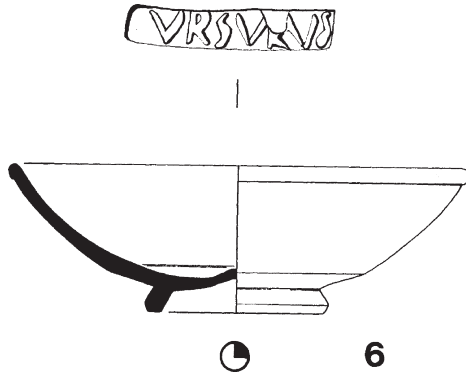

FIG. 4.8 Bowl from urned cremation burial 9.

brown with concentrations of cremation debris especially in the eastern part.

**Interpretation** No material survives in the archive but description suggests either loose cremation burial or redeposited pyre debris.

## 12 1967/133 PHASE 1

Plan FIG. 4.2; details FIG. 4.10.

**Description** Oval pit with steeply sloping sides and flat bottom (0.8 x 0.46m; major axis N/S). Fill: light brown with urned cremation burial (2) and accessories (3 and 4) possibly placed centrally. Possibly truncated by ploughing or machine.

**Cremated human bone** Juvenile–adult (5–100 years); unsexed. Wt. 8.9g.

### Pyre goods

1 S00. Wt. 5g. A scrap of Dr. 31R, burnt.

### Grave goods

2 O01. Wt. 330g. BE 27 (BC/IR). A total of 117 sherds from the wall and base of a jar. Perhaps second to third-century.

3\* F04. Wt. 105g. RE 16, BE 100 (BC/IS). A complete profile of a Central Gaulish Rhenish ware beaker with barbotine scroll decoration, Gillam (1970) type 48, A.D. 200–250. c. A.D. 150–200.

4\* S20. Wt. 1100g. RE 78, BE 100 (BC/IQ). Form 38, almost complete, but lacking most of the rim and some of the flange, Central Gaulish, possibly from Vichy. The footring and the top of the flange are very weathered and the interior from flange level down very worn. Late-Antonine. (See also 9.7 for more fragments of this bowl.)

**Interpretation** Urned cremation burial.

## 13 1967/160 PHASE 1

Plan FIG. 4.2; details FIG. 4.11.

**Description** Oval pit with steep sides and flat base (0.53 x 0.42m; major axis W/E). Fill: light brown

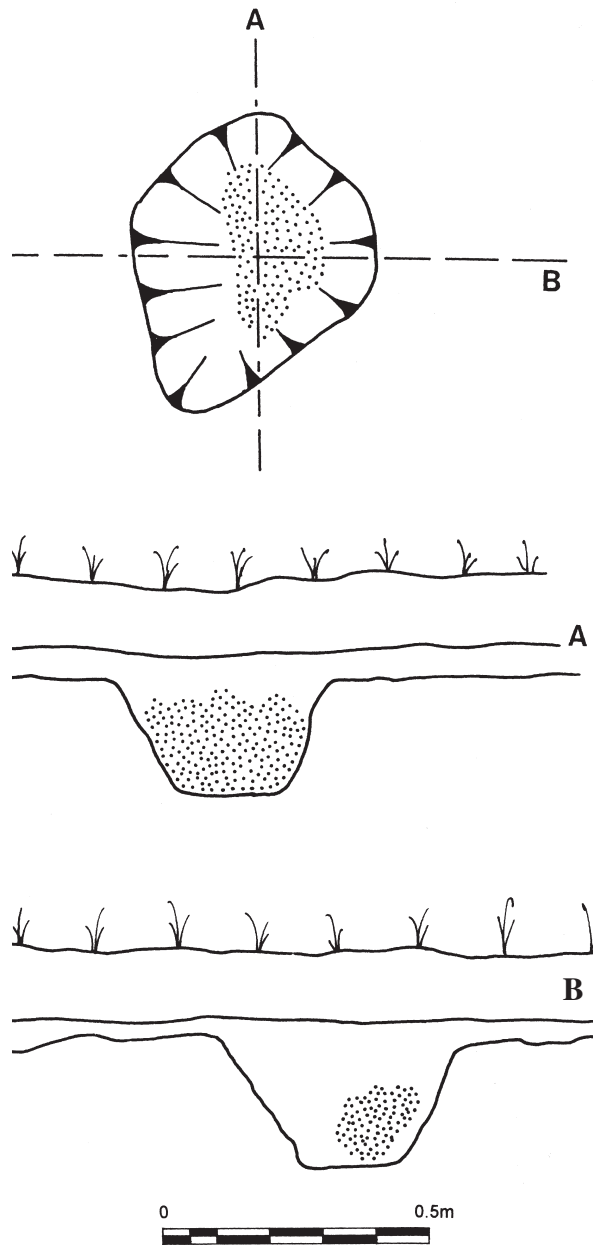

FIG. 4.9 Plan and section of possible pyre debris deposit 10.

with urned cremation placed centrally, occupying full N/S dimensions. Cremated bone placed in (2), (3) placed in mouth of urn.

**Cremated human bone** Adult (40–60 years); female. Wt. 1324.6g (including 0.3g animal bone). Pathology: exo – iliac crest.

### Pyre goods

1 B01. Wt. 4g. (BC/KY). A very burnt BB1 bodysherd. Hadrianic to mid fourth-century.

### Grave goods

2\* O01. Wt. 2200g. RE 100, BE 100 (BC/KY). A complete constricted-necked jar. Cf. Gillam (1970) type 30, A.D. 160–210. Later second to early third-century.

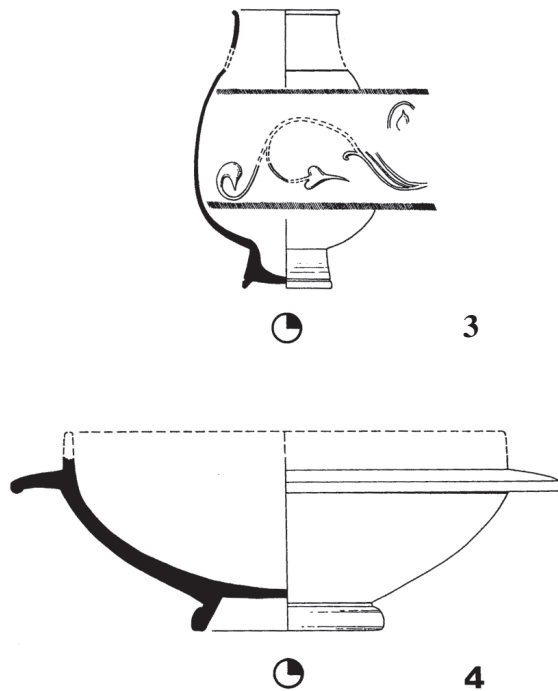

FIG. 4.10 Grave goods from urned cremation burial 12.

- 3 B01. Wt. 105g. BE 69. Four base sherds and 21 bodysherds from the lower wall of a BB1 jar, all sherds being heavily burnt orange. Hadrianic to mid fourth-century.

**Interpretation** Urned cremation burial.

#### 14 1967/220 UNPHASED

Plan FIG. 4.2; details FIG. 4.12.

**Description** Partial cist with sandstone slabs on northern side of square steep-sided pit with flat base (0.76 x 0.71m; major axis N/S). Fill: light brown with considerable traces of charcoal. No material collected.

**Interpretation** Redeposited pyre debris.

#### 15 1967/215 PHASE 2

Plan FIG. 4.2; details FIG. 4.13.

**Description** Long cist in rectangular pit, sides partially lined with sandstone slabs including tombstone 5 (2.06 x 0.95m, major axis NW/SE). Fill: light brown with scatter of sherds over base of pit, and a scatter of cremated bone and charcoal behind slabs on south-western side. See Tombstone 5, Chapter 10, FIG. 10.4.

**Cremated human bone** Adult (18–100 years); unsexed. Wt. 49.7g (including 0.3g animal and 0.4g worked bone).

**Charcoal** *Betula* sp. (\*).

**Pyre goods**

- 1 Iron; nail.

#### Finds in fill

- 2 B01. Wt. 135g. BE 30 (BC/ND). Thirteen bodysherds from a BB1 jar with obtuse lattice zone with groove above. *c.* A.D. 240–350.
- 3 B01. Wt. 75g. RE 14, BE 4 (BC/ND). Two rimsherds and a base sherd from a simple-rimmed dish, with intersecting arc decoration, the base has intersecting circles, exterior sooted. *c.* A.D. 200–350.

**Interpretation** ?Inhumation.

#### 16 1967/139 PHASE 3

Plan FIG. 4.2; details FIG. 4.14.

**Description** Sub-circular pit with deeper depression in south-western corner (0.5 x 0.42m; major axis N/S). Fill: light brown with urned cremation burial set in depression. Truncated by plough or machine.

**Cremated human bone** Two groups. (i) from jar (4), (ii) from sample taken from surface of (4) prior to lifting urn.

- (i) Adult (30–40 years); female. Wt. 357.1g (including 0.7g worked bone).
- (ii) Adult (18–100 years); unsexed. Wt. 16.4g.

**Charcoal** *Betula* sp.

**Pyre goods**

- 1 Iron; nail.
- 2 Bone veneer types: A2.2\*; A4; A4.4; A5.5; B2.2; E2.1.
- 3 B01. Wt. 5g. Two very burnt BB1 bodysherds.

**Grave goods**

- 4\* B01. Wt. 1400g. RE 86, BE 71 (BC/JE). Most of a BB1 jar with everted rim, its diameter not exceeding the maximum girth, with an obtuse lattice zone with groove above, exterior sooted. *Cf.* Gillam (1976) no. 9, mid to later third-century. *c.* A.D. 240–270.

**Finds of uncertain status**

- 5 F03. Wt. 1g. (BC/JE). A Nene Valley colour-coated ware bodysherd.
- 6 B01. Wt. 4g (BC/JE). A flange fragment from a BB1 developed beaded-and-flanged bowl. Later third to mid fourth-century.

**Interpretation** Urned cremation burial.

#### 17 1967/182 UNPHASED

Plan FIG. 4.2; details FIG. 4.15.

**Description** Cist in steep-sided square pit with flat base (pit 0.88 x 0.84m; cist 0.63 x 0.63m; major axis NE/SW). Fill: light brown with scatters of bone and charcoal concentrations. Relationships: cuts F32.



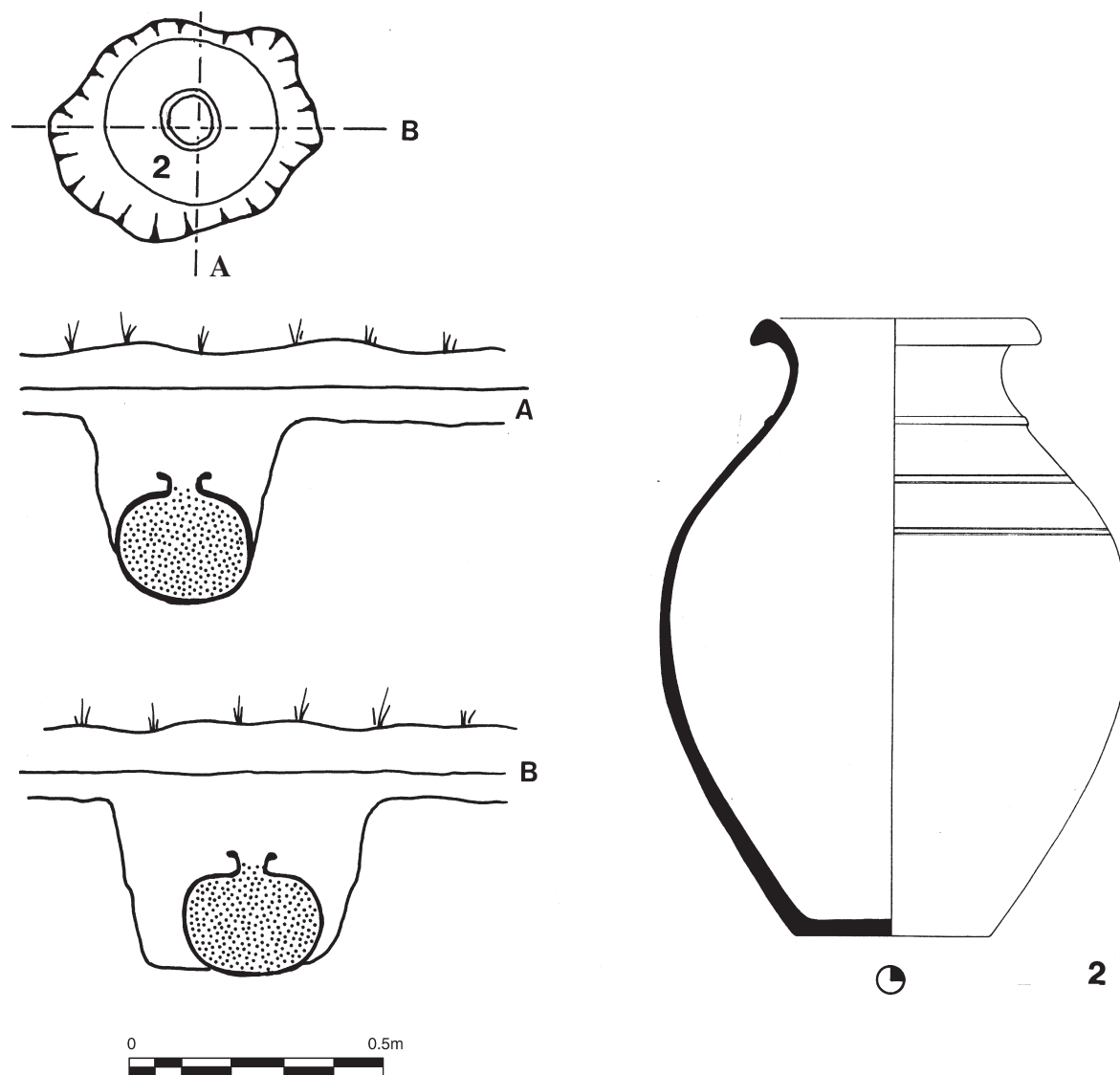

FIG. 4.11 Plan, section and urn from urned cremation burial 13.

**Cremated human bone** Adult (18–100 years); unsexed. Wt. 71.2g (including 7.5g worked bone). Heavily charcoal-stained.

**Pyre goods**

- 1 Copper alloy; fragment.
- 2 Iron; hobnail, found in cremated bone.
- 3 Iron; nails (4).
- 4 Bone veneer types: A3.1; A4; A7.1; B1.1; C2.1; E3; F.
- 5 B01. Wt. 220g. BE 76 (BC/LS). A BB1 jar base and many bodysherds from the lower wall, some burnt. Hadrianic to mid fourth-century.

**Finds of uncertain status**

- 6\* F01. Wt. 40g. (BC/LS(A)). The base from a globular Rhenish Trier beaker. c. A.D. 200–60.

**Interpretation** Redeposited pyre debris.

**18 1967/212 PHASE 2**

Plan FIG. 4.2; details FIG. 4.16.

**Description** Rectangular pit with sloping sides and flat base (0.7 × 0.38m; major axis N/S). Fill: light brown with concentration of cremation debris especially to N. Relationships: cuts F37.

**Cremated human bone** Adult (18–100 years); unsexed. Wt. 19.2g (including 1.5g worked bone).

**Pyre goods**

- 1 Copper alloy; fragment (found in cremated bone); molten fragments (2).
- 2 Iron; hobnails (20).
- 3 Iron; nails (11 including 8 fragments).
- 4 Bone veneer types: B1.1; C2.1.
- 5\* B01. Wt. 115g. RE 21, BE 55 (BC/NA). Most of the lower two-thirds of a BB1 jar and

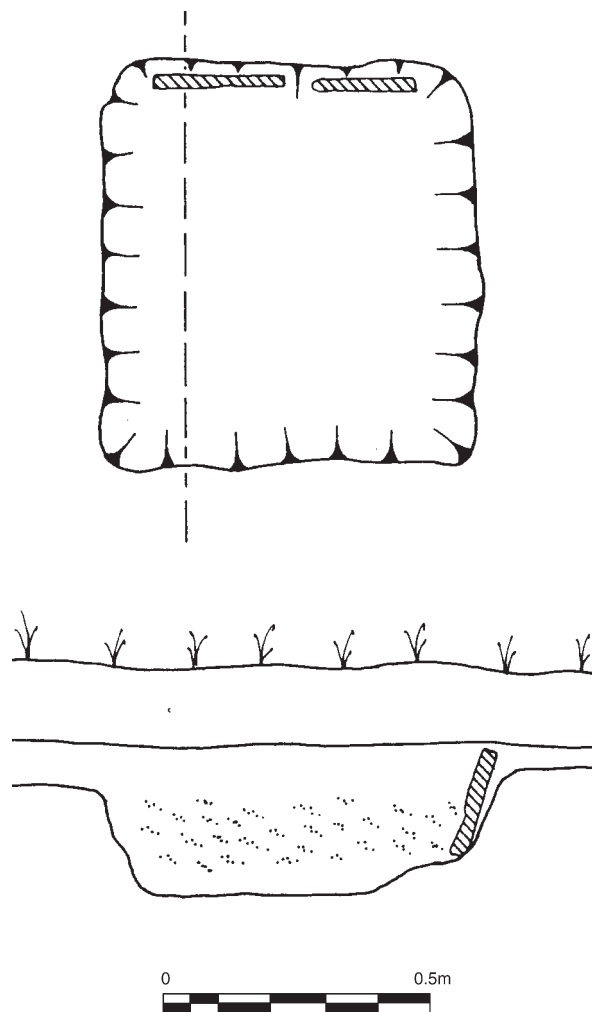

FIG. 4.12 Plan and section of pyre debris deposit 14.

some rim fragments. The everted rim has a lesser diameter than the maximum girth and the obtuse lattice zone has a groove above it. Most of the sherds are burnt. Cf. Gillam (1976) no. 9, mid to late third-century. c. A.D. 240–270.

**Interpretation** Redeposited pyre debris.

### 19 1967/149 PHASE 3

Plan FIG. 4.2; details FIG. 4.17.

**Description** Oval pit with sandstone slab on southern side (0.36 x 0.3m, major axis NE/SW). Fill: light brown. Cremated bone from (4).

**Cremated human bone** Infant–juvenile (3–7 years); unsexed. Wt. 8.4g.

**Charcoal** *Betula* sp. (xx).  
*Alnus* sp. (x).

#### Pyre goods

- 1 Iron; nail (3 including fragments).
- 2 Bone veneer type: B1.1.

- 3 B01. Wt. 145g. RE 17, BE 17. Two rim fragments, eight bodysherds and a base sherd from a BB1 jar with strongly everted rim, sooted, with obtuse lattice zone with groove above, several sherds burnt; from fill. Cf. Gillam (1976) nos 12–14, early to mid fourth-century. Later third to mid fourth-century.

#### Grave goods

- 4\* B01. Wt. 390g. RE 5 (BC/JL). Fragments from a BB1 jar shoulder and rim, some sherds burnt, twelve sherds have obtuse lattice decoration, none grooved, some sherds

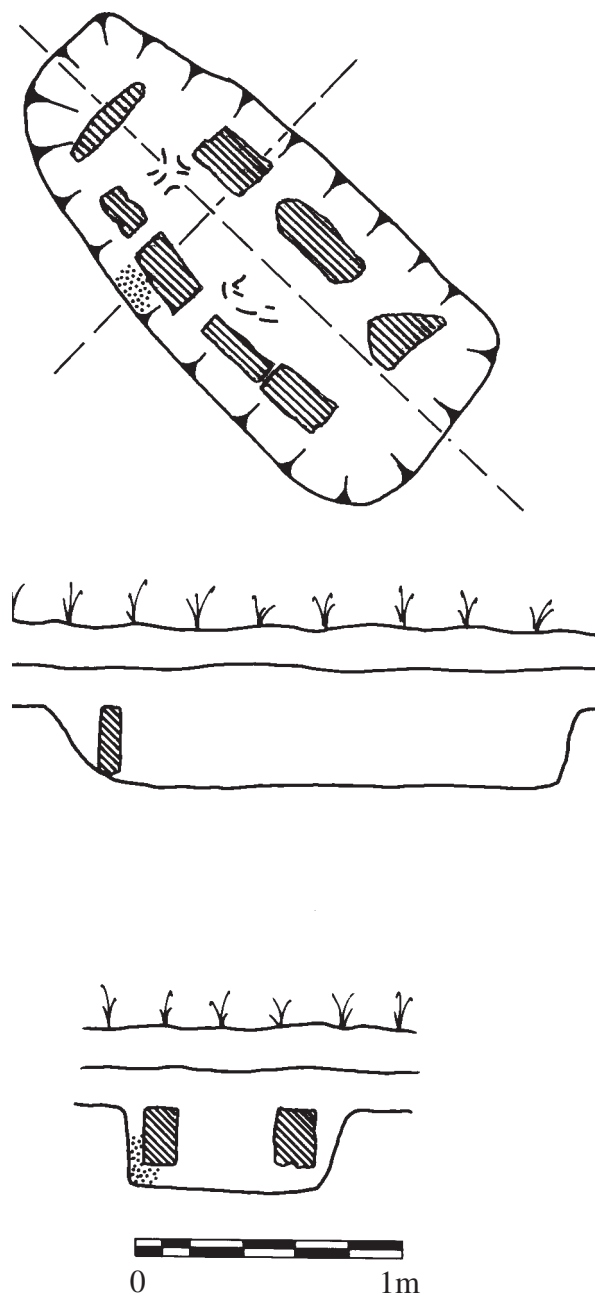

FIG. 4.13 Plan and sections of long cist 15.

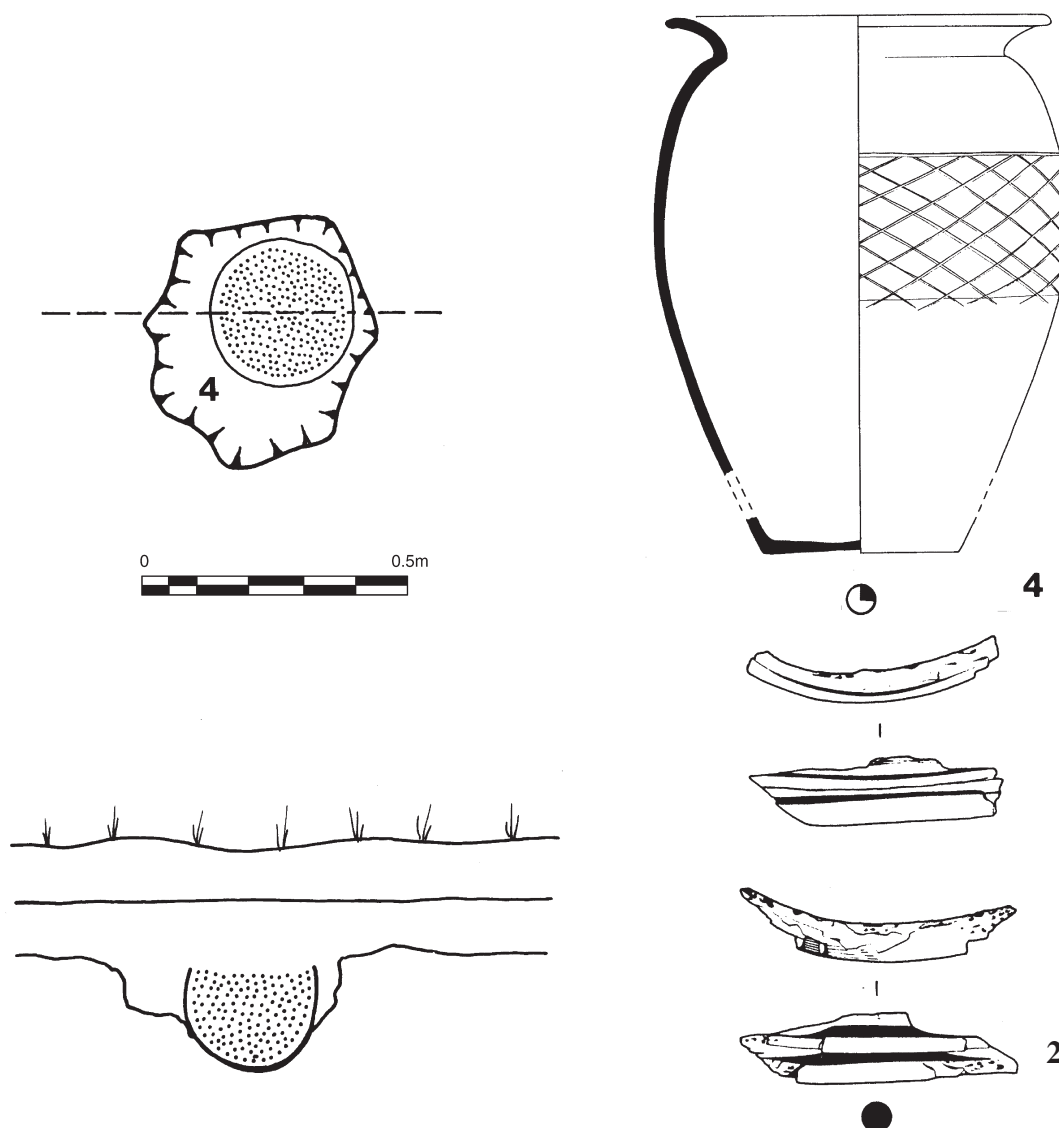

FIG. 4.14 Plan, section, pyre goods and urn from urned cremation burial 16.

sooted. Cf. Gillam (1976) no. 11, later third to mid fourth-century.

#### Finds of uncertain status

- 5 B01. Wt. 14g. RE 15 (BC/JL). A BB1 jar rim (3 joining fragments), everted, sooted. Probably third-century.

**Interpretation** Urned cremation burial.

#### 20 1967/156 PHASE 3

Plan FIG. 4.2; details FIGS 4.18, 4.19.

**Description** Cist in rectangular steep-sided pit with flat base; sandstone slabs lining walls (0.74 x 0.42m; major axis W/E). Fill: light brown with cremated bones in (6) in NW corner, accessory jar (7) in NE corner and samian accessory dish (8) between them. Accessory jar (7) covered by sandstone slab.

**Cremated human bone** Adult (40–50 years); male.

Wt. 576.4g (including 5g worked bone and ivory). Pathology: abscess – maxillary left M1.

#### Pyre goods

- 1 Iron: hobnail (2 found in cremated bone).  
 2 Iron; nail (2).  
 3\* Bone; piece ?chape. Two small fragments.  
 4 Ivory; fragments (2).  
 5 B01. Wt. 3g. (BC/KU(A)). A BB1 bodysherd, heavily burnt. Hadrianic to mid fourth-century.

#### Grave goods

- 6\* R03. Wt. 2400g. RE 29, BE 100 (BC/KU(A)). Most of a constricted-necked jar with a bifid, frilled rim. Probably north-western and early to mid third-century.  
 7\* B01. Wt. 610g. RE 41, BE 100 (BC/JV). Part of the rim and most of a BB1 jar with everted rim of, perhaps, greater diameter than the maximum girth, with an obtuse lattice zone on the latter with a groove above. Cf. Gillam

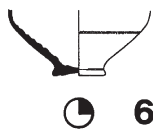
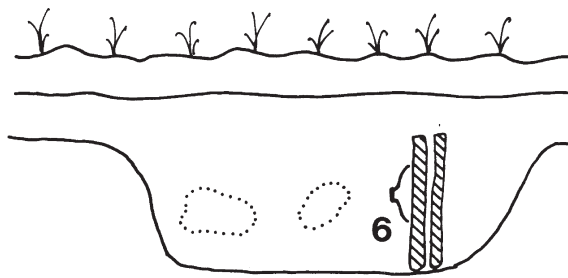
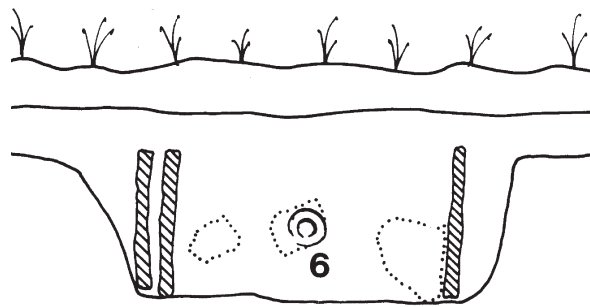
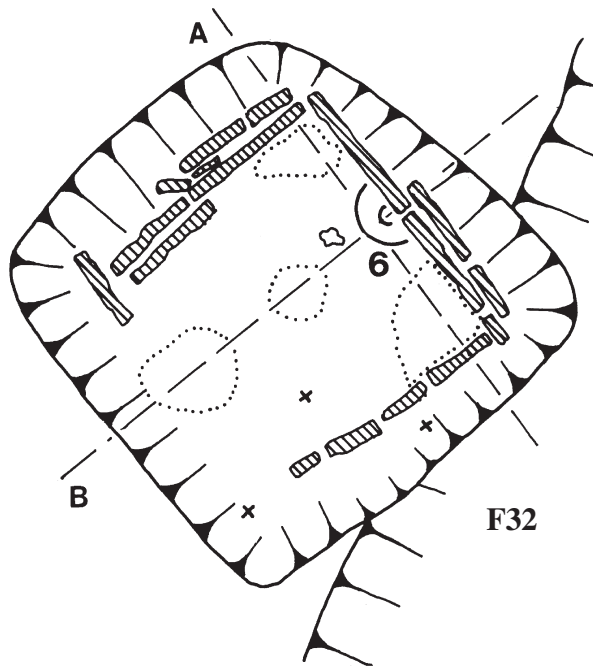

FIG. 4.15 Plan, section and pyre goods from pyre debris deposit 17.

(1976) nos 10–11, later third to early fourth-century. *c.* A.D. 270–300.

- 8\* S30. Wt. 775g. RE 90, BE 78 (BC/KW). Form 31R (Sb/Sh). East Gaulish (Trier). Almost complete, in many pieces, very abraded inside, though less so on the outside. The footring is heavily eroded and possibly worn. The stamp PARE T[I VS] is almost certainly from Die 2b of Parentinus of Trier. For details of the potter see 264.6.

#### Finds of uncertain status

- 9 B01. Wt. 5g. (BC/KU(B)). Two joining BB1 jar shoulder sherds. Hadrianic to mid fourth-century.
- 10\* R13. Wt. 400g. RE 26 (BC/KU(B)). Two rim fragments and 16 greyware bodysherds from a necked jar.

**Interpretation** Urned cremation burial.

#### 21 1967/158 PHASE 1

Plan FIG. 4.2; details FIG. 4.20.

**Description** Oval pit with steep sides and flat base (0.69 x 0.55m; major axis NW/SE). Fill: light brown with cremated bone placed in (1), and two accessory vessels (2 and 3) placed centrally; mouth of cremation urn covered by sandstone slab.

**Cremated human bone** Adult (18–100 years); unsexed. Wt. 173.5g (including 1.3g animal bone).

**Cremated animal bone** Large ungulate.

#### Grave goods

- 1\* B01. Wt. 650g. RE 100, BE 70 (BC/KF). Much of a BB1 jar, the rim is complete but part of the base is missing, quite heavily sooted, with everted rising rim of lesser diameter than the maximum girth and with obtuse lattice zone on girth (without groove). *Cf.* Gillam (1976) no. 7, early to mid third-century. Perhaps *c.* A.D. 200/220–240.
- 2\* B01. Wt. 475g. RE 74, BE 100 (BC/KE). Much of a tubby BB1 cooking pot, with everted rising rim and acute lattice decoration on the body. *Cf.* Gillam (1976) nos 6–7, early to mid third-century. *c.* A.D. 150–200/220.
- 3\* S20. Wt. 525g. RE 100, BE 100 (BC/KD). Form Ludowici Tg, complete, with slightly worn footring. The potter's stamp reads ROT(TLLIM) (Die 1a). Rottalus worked at Lezoux in the mid to late-Antonine period. This stamp occurs at Benwell and Chesters forts and on forms 31R, 79, 79R and 80. *c.* A.D. 160–200.

**Interpretation** Urned cremation burial.

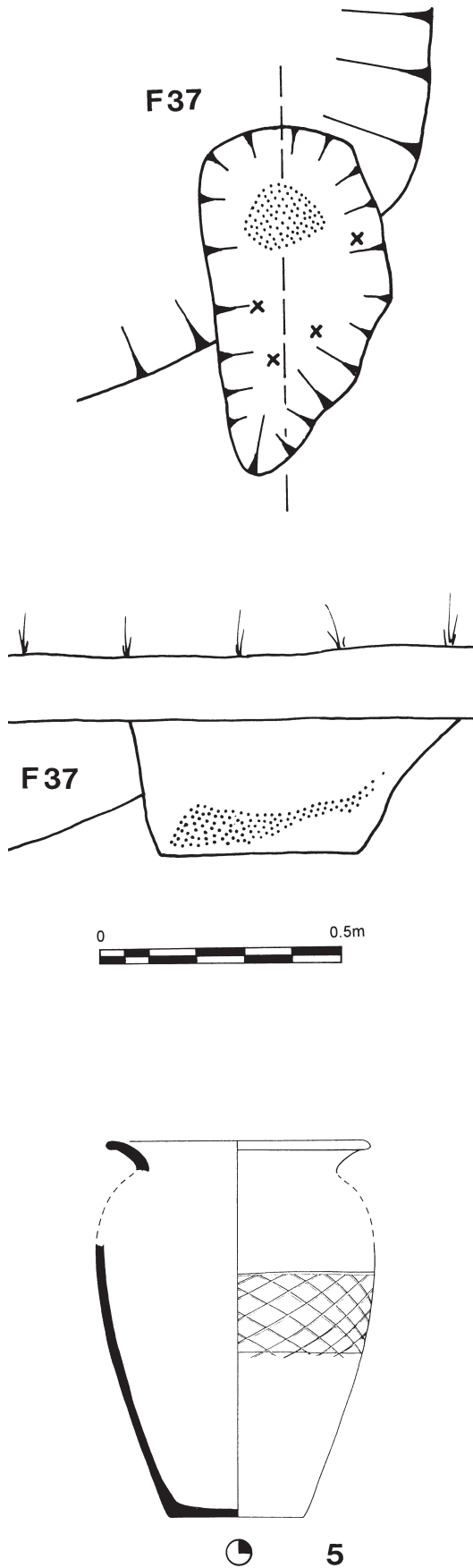

FIG. 4.16 Plan, section and pyre goods from pyre debris deposit 18.

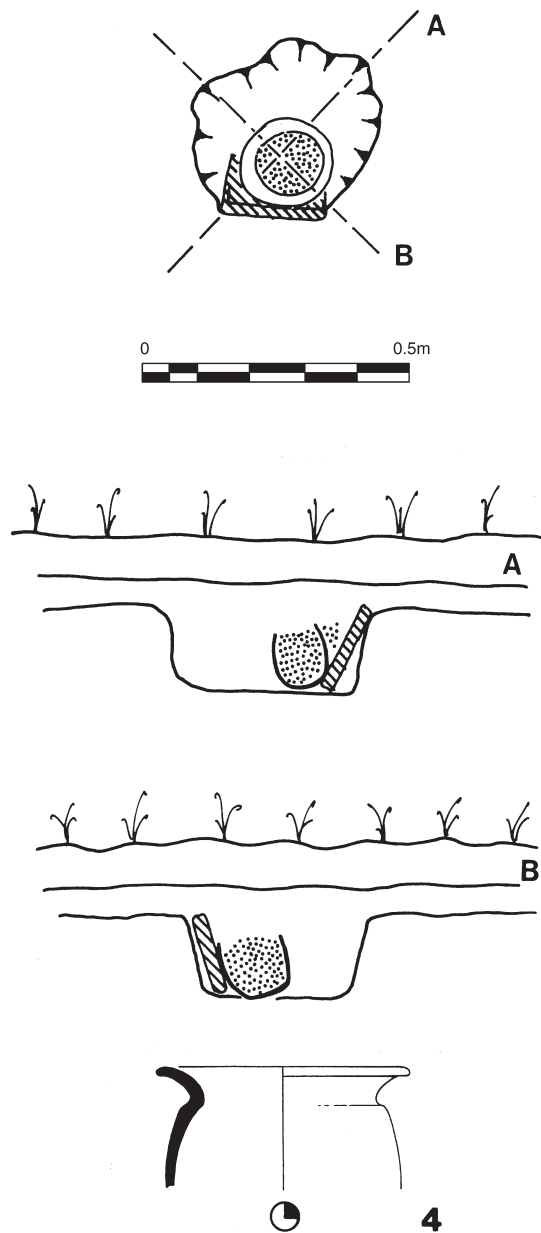

FIG. 4.17 Plan, section and urn from urned cremation burial 19.

22 1967/159 PHASE 2

Plan FIG. 4.2; details FIG. 4.21.

**Description** Oval pit with steeply sloping sides and flat base (0.61 x 0.5m; major axis N/S). Fill: light brown with urned cremation (7) to N, accessory dish (9) to SW and beaker (8) placed on its side to E.

**Cremated human bone** Two groups from one individual. (i) from jar (7), (ii) from beaker (8).

- (i) Adult (18–100 years); unsexed. Wt. 13.6g (including 0.6g worked bone).
- (ii) Adult (18–100 years); unsexed. Wt. 14.7g (including 0.9g worked bone).

**Pyre goods**

- 1\* Copper alloy; stud, diameter 25mm, L. 8mm.

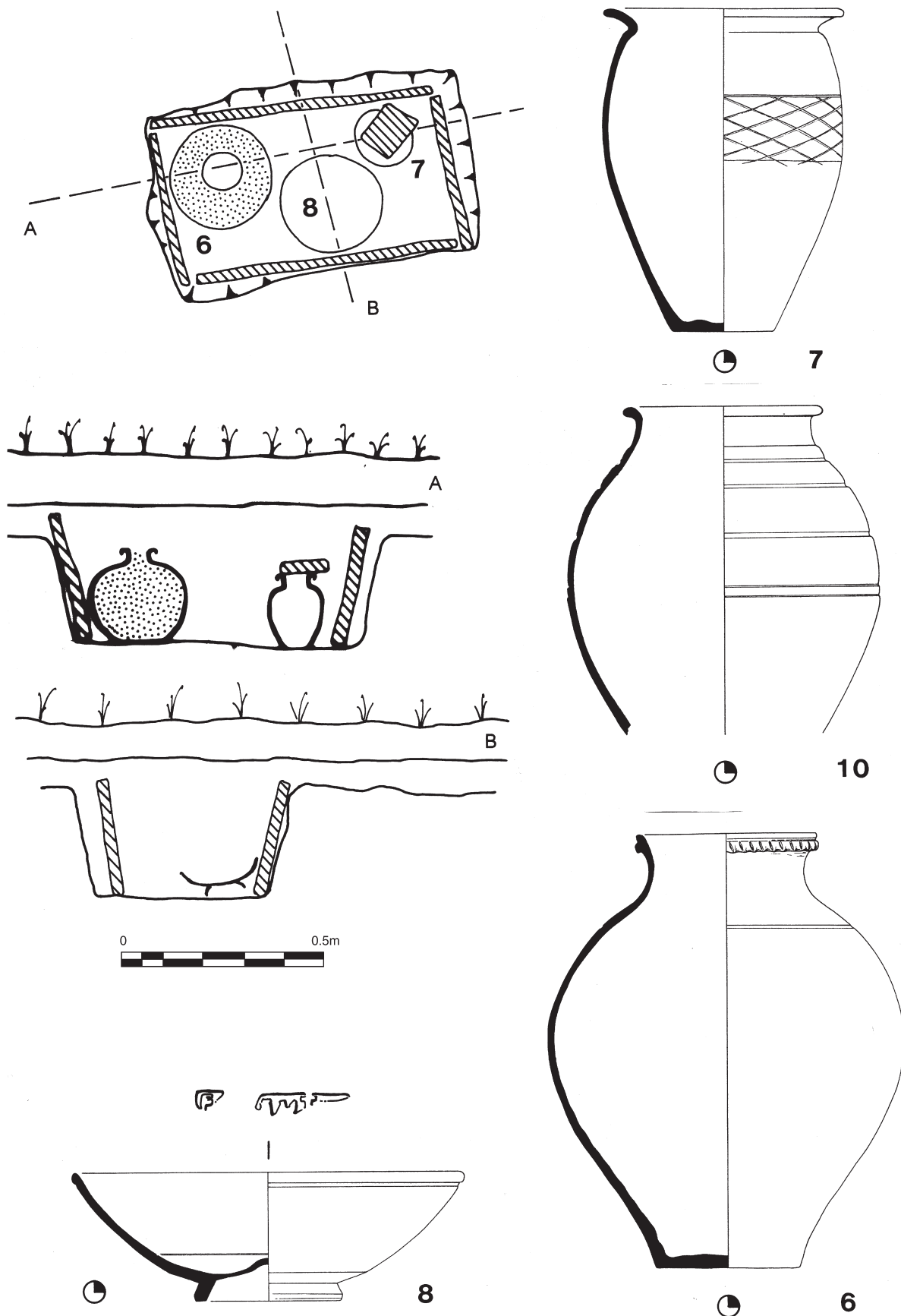

FIG. 4.18 Plan, section, grave goods and jar (10) of uncertain status from urned cremation burial 20.

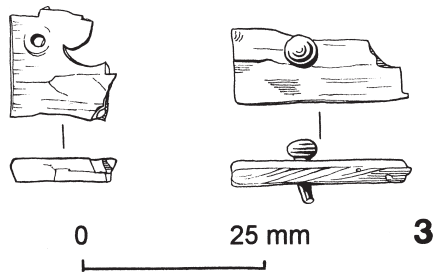

FIG. 4.19 Bone chape fragments from urned cremation burial 20.

- 2 Iron; hobnail.
- 3 Iron; nail associated with jar (7).
- 4 Iron; nail (2 plus fragments) associated with beaker (8).
- 5 Iron; nail (2 fragments) found in cremated bone.
- 6 Bone veneer types:A5.4; A7.1; D\*.

#### Grave goods

- 7\* B01. Wt. 600g. BE 100 (BC/KG). A complete profile of a BB1 jar from the shoulder down, with obtuse lattice zone on girth, with groove above, sooted, and several sherds heavily burnt. *c.* A.D. 240+.
- 8\* F02. Wt. 550g. RE 100, BE 100 (BC/KH). A slit-folded Nene Valley colour-coated oxidised beaker with rouletted horizontal line decoration, a form clearly copying early to mid third-century Trier forms, *cf.* Gillam (1970) type 44, A.D. 190–240; Howe *et al.* (1980) nos 52–3 illustrate fourth-century examples. The form is an early to mid third-century one, although it does not seem to have been copied until the mid third century, which is unusual, perhaps it started at the point when real Trier beakers were becoming scarce.
- 9\* S30. Wt. 550g. RE 96, BE 100 (BC/KI). Form 31 (Sa), almost complete, stamped PA TOR by Pastor iii (Die 1a). The footring of this dish appears to be well worn and the inside of the dish is heavily eroded. A homonym began work at Kräherwald and moved to Rheinabern, where his output was entirely forms 32 and 32R. This dish and the one stamped with the same die 160.4 are, however, in Trier fabric and will almost certainly be the work of another man. None of his stamps is known from Trier, or anywhere else but Brougham. Probably first half of the third century.

#### Finds of uncertain status

- 10 B01. Wt. 4g. (BC/KG). A BB1 dish/bowl bodysherd, interior and exterior burnished, sooted. Hadrianic to mid fourth-century.

- 11 ?R08. Wt. 3g. ( BC/KG). A greyware bodysherd with oxidised core, exterior decorated with acute lattice. Hadrianic to Antonine.

**Interpretation** Either urned cremation burial or, given small quantity of human bone in this undisturbed burial, a vessel deposit or memorial.

#### 23 1967/137 PHASE 3

Plan FIG. 4.2; details FIG. 4.22.

**Description** Circular pit with steep sides and flat base (diameter 0.38m). Fill: light brown, samian dish (3) placed in base of pit first followed by flagon (2) and then urn containing cremation burial (1). Truncated by plough or machine.

**Cremated human bone** Juvenile (7–10 years); unsexed. Wt. 124g. Pathology: infection – femur.

#### Grave goods

- 1\* B01. Wt. 825g. RE 12, BE 82 (BC/JB). An apparently fairly complete BB1 jar except that most of the rim is missing, with an everted rim, the diameter is around that of the maximum girth, with obtuse lattice zone with a groove above, exterior sooted. *Cf.* Gillam (1976) no. 10, later third century. *c.* A.D. 260–280.
- 2\* F02. Wt. 450g. BE 100 (BC/JD). A disc-necked flagon in Nene Valley colour-coated ware with rouletted bands. *Cf.* Perrin (1999) 98, third to fourth-century.
- 3\* S30. Wt. 440g. RE 100, BE 100 (BC/JC). Eight fragments giving a complete dish of a deep variety of form 31(Sa), East Gaulish (Trier). The footring shows moderate wear. The vessel was never stamped. Probably third-century.

**Interpretation** Urned cremation burial.

#### 24 1967/141 PHASE 4

Plan FIG. 4.2; details FIG. 4.23.

**Description** Long cist placed in steep-sided rectangular pit, sides and base lined with sandstone slabs and cist capped by similar slabs. The SE end of cist removed by 26 (>1.18 x 0.61m; major axis NW/SE). Fill: light brown, sandstone slabs collapsing into 26 include (1–4) and scatter of wood charcoal which may have been resting on capping slab. Relationships: cut by 26.

**Cremated human bone** Adult (18–100 years); unsexed. Wt. 12.5g.

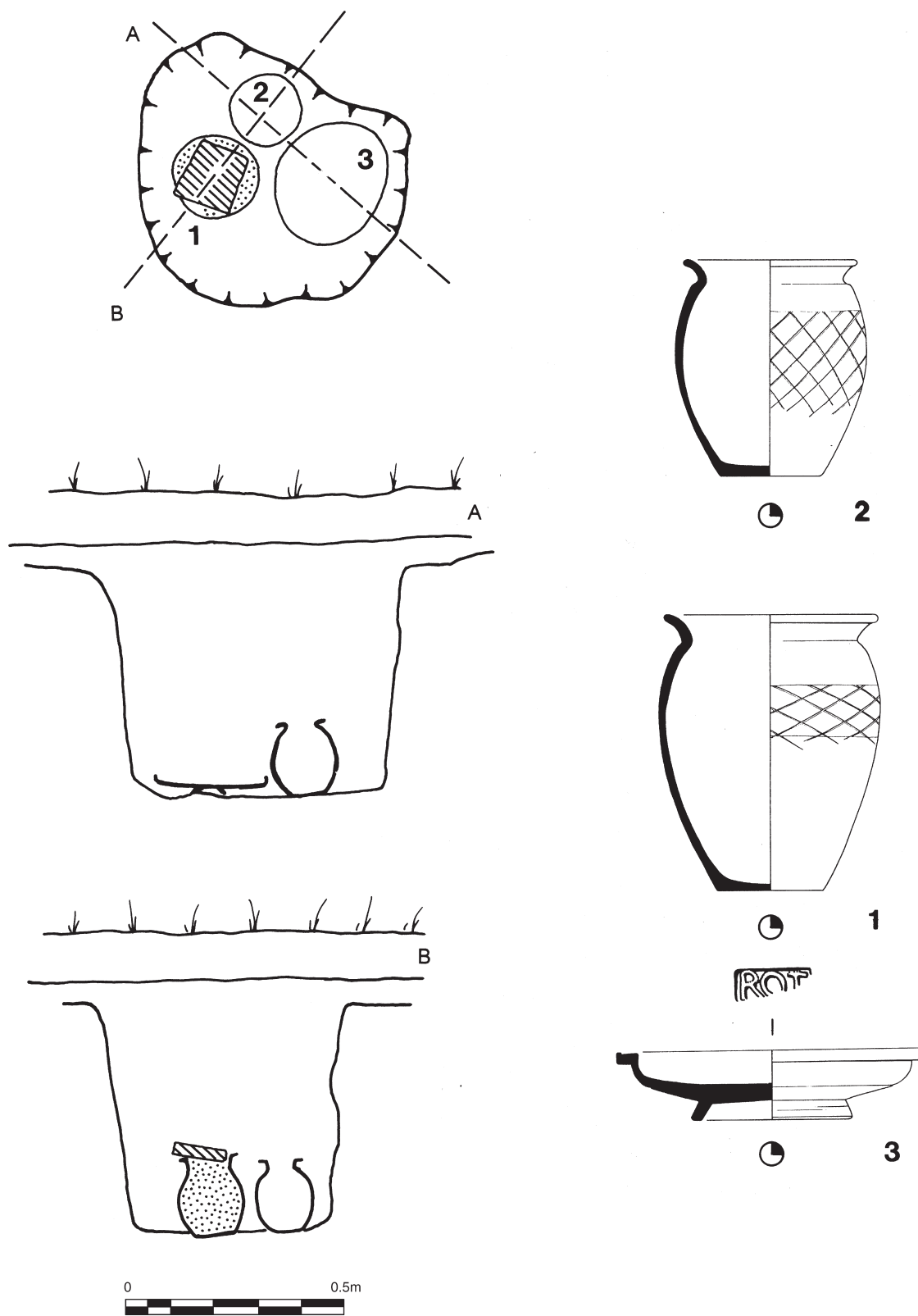

FIG. 4.20 Plan, section and grave goods from urned cremation burial 21.



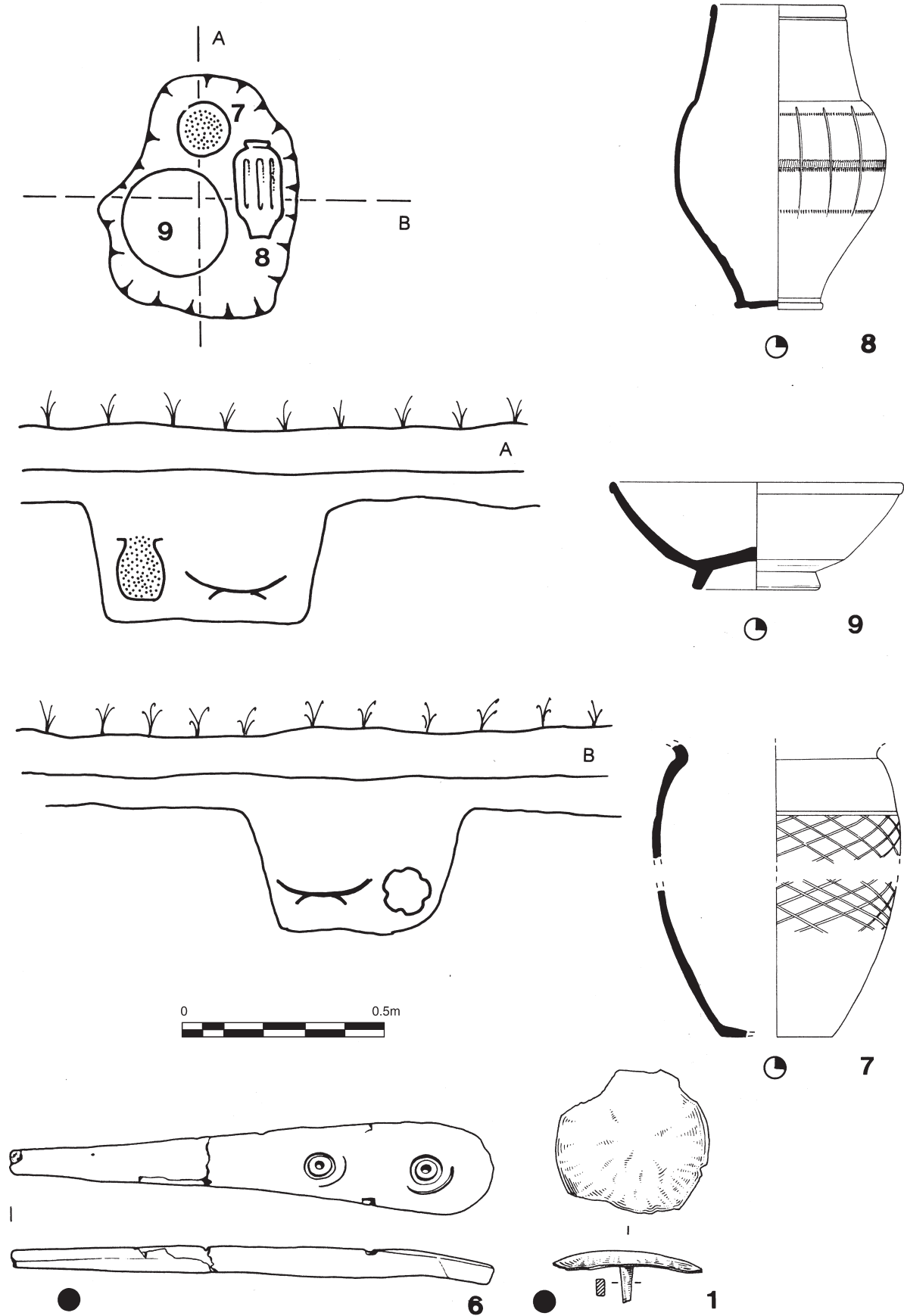

FIG. 4.21 Plan, section, pyre and grave goods from urned cremation burial 22.

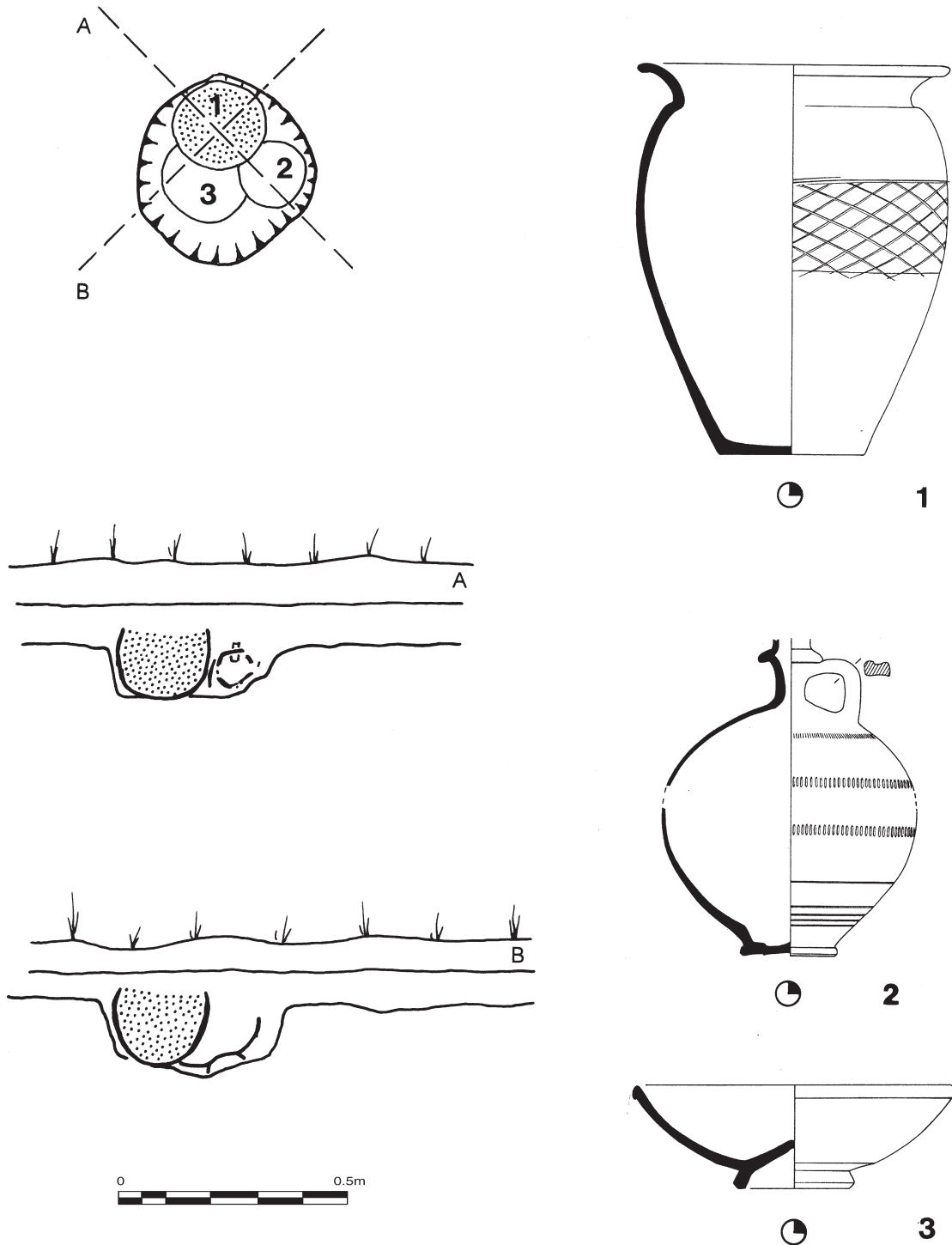

FIG. 4.22 Plan, section and grave goods from urned cremation burial 23.

**Charcoal** *Quercus* sp. (xx).  
*Betula* sp. (x).

**Finds of uncertain status**

- 1 F01. Wt. 1g. (BC/JV). A Trier Rhenish ware bodysherd, c. A.D. 200–260.  
2\* F02. Wt. 44g. BE 100 (BC/JV). A base of a Nene Valley colour-coated ware indented beaker. c. A.D. 160/170+.

- 3 F03. Wt. 3g. RE 10 (BC/JV). A Nene Valley colour-coated ware cornice-rimmed beaker rim fragment. c. A.D. 160/170–250.  
4 B01. Wt. 43g. (BC/JV). Seven sherds from a BB1 jar including sherds with obtuse lattice decoration. Third to fourth-century.

**Interpretation** Inhumation burial.

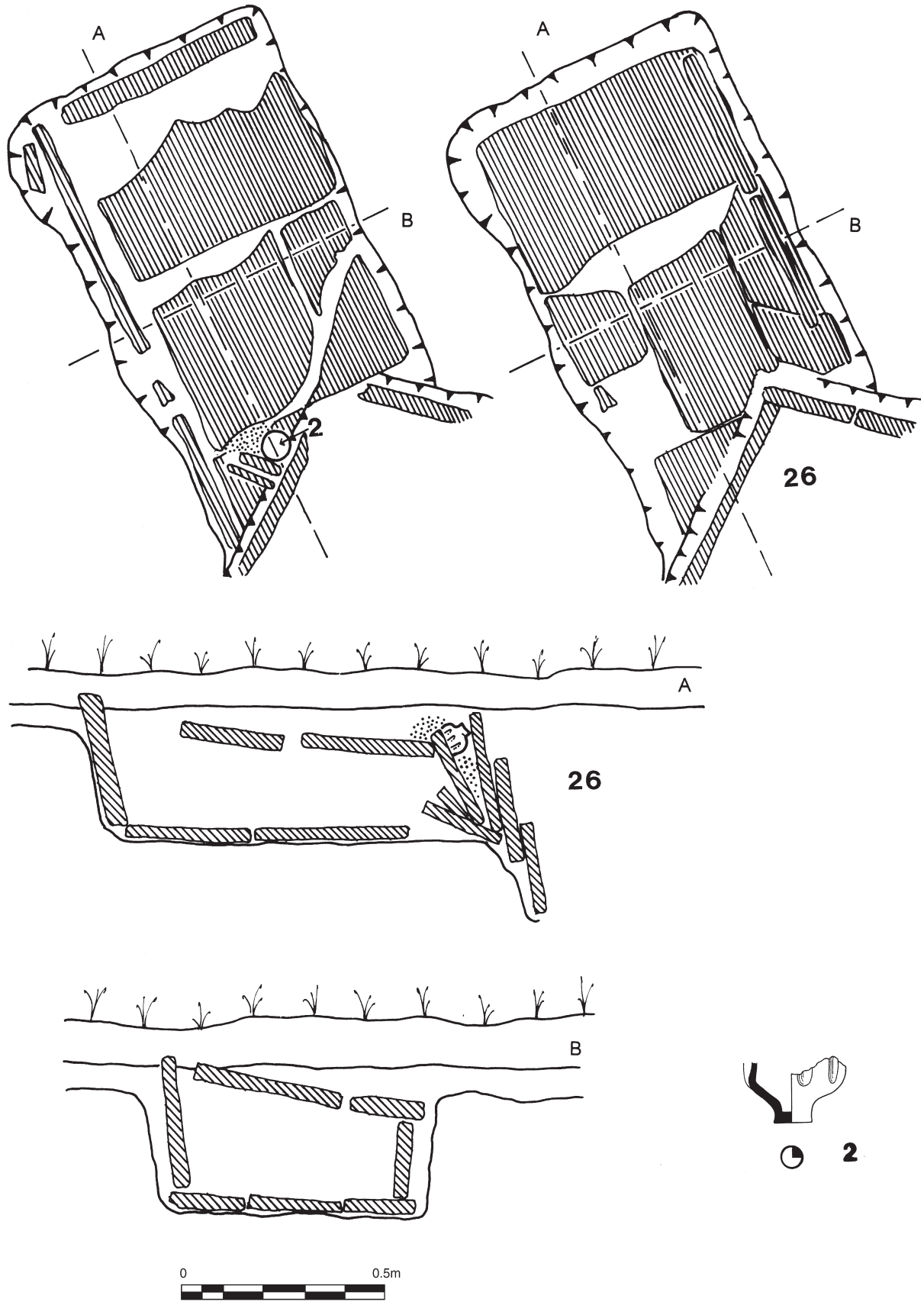

FIG. 4.23 Plan, section and finds from fill of long cist 24.

## 25 1967/138 PHASE 4

Plan FIG. 4.2; details FIG. 4.24.

**Description** Long cist placed in steep-sided rectangular pit, sides and base lined with sandstone slabs; capping stones missing (1.28 x 0.36m; major axis N/S). Fill: light brown.

**Interpretation** Inhumation burial.

## 26 1967/153 PHASE 4

Plan FIG. 4.2; details FIG. 4.25.

**Description** Long cist placed in steep-sided rectangular pit, sides lined with sandstone slabs; parts of capping slabs impacted into fill (1.82 x 0.76m; major axis N/S). Fill: light brown with small quantity of cremated bone and sherds resting on one of impacted capping stones. Relationships: cuts 24.

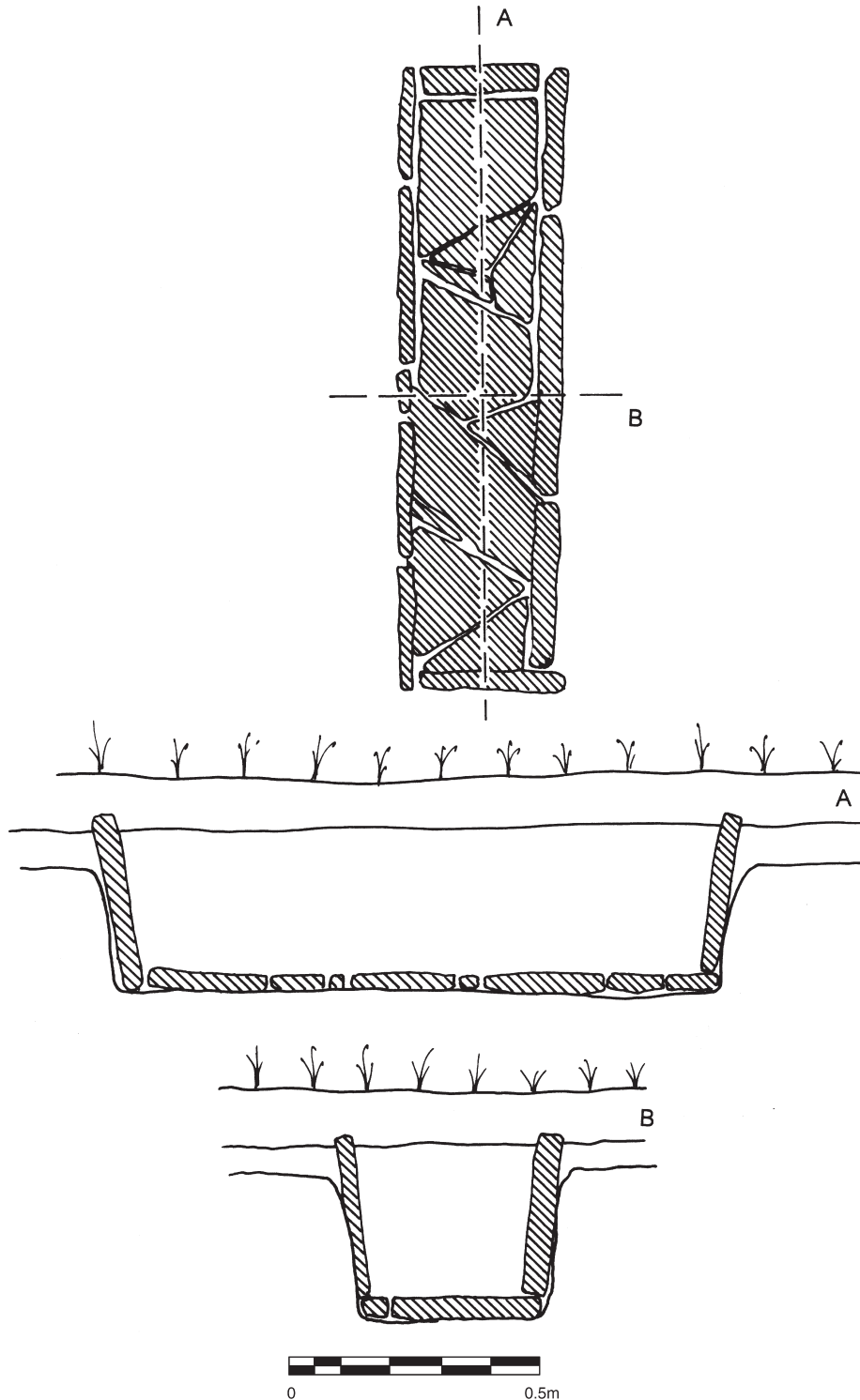

FIG. 4.24 Plan and section of long cist 25.

**Cremated human bone** Adult (18–45 years); unsexed. Wt. 59.5g (including 1.6g worked bone).

**Charcoal** *Fraxinus* sp. (xx).

*Betula* sp. (xx).

*Alnus* sp. (x).

**Pyre goods**

1 Iron; strap or blade fragments (7).

2 Iron; nail (6 including fragments).

**Finds of uncertain status**

3 BO1. Wt. 12g. BE 4 (BC/KB). Two BB1 dish/

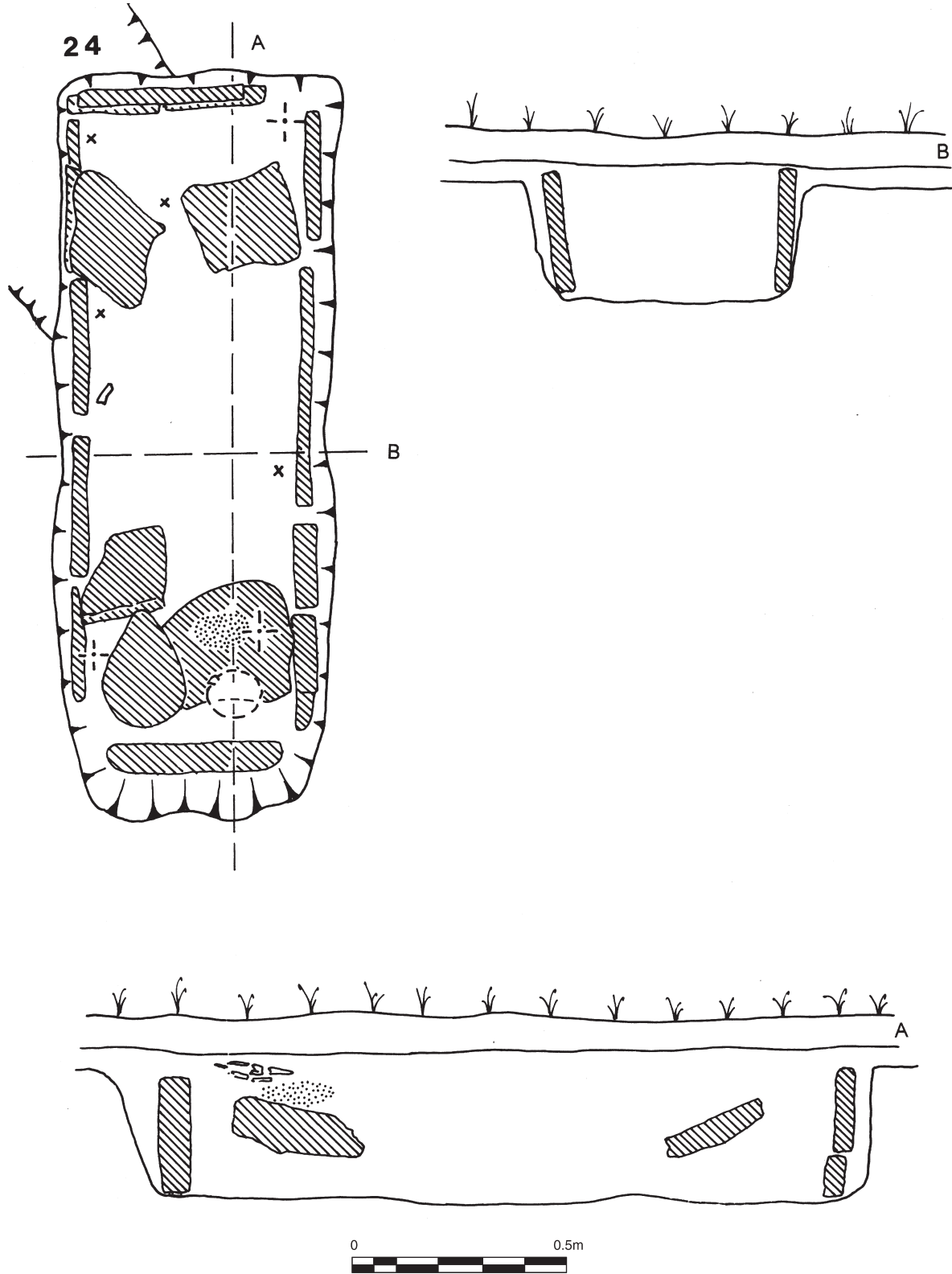

FIG. 4.25 Plan and section of long cist 26.

- bowl base sherds with intersecting arcs on the base. Hadrianic to mid fourth-century.
- 4 B01. Wt. 72g. BE 10 (BC/KB). Nine BB1 jar bodysherds and a base sherd with obtuse lattice zone on girth with groove above, sooted. *c.* A.D. 240+.
- 5 O01. Wt. 47g. (BC/KB), u/s. Fourteen bodysherds from an oxidised jar/constricted-necked jar. Second to third-century.
- 6 ?O02. Wt. 6g. (BC/KB), u/s. An oxidised bodysherd.
- 7 A01. Wt. 6g. (BC/KB). ?Dressel 20 bodysherd. First to third-century.
- 8 F03. Wt. 1g. (BC/KB). A Nene Valley colour-coated ware bodysherd. *c.* A.D. 160/170+.
- 9 S20. Wt. 1g. A Central Gaulish flake. Second-century.

**Interpretation** Inhumation burial.

## 27 1967/155 PHASE 2

Plan FIG. 4.2; details FIG. 4.26.

**Description** Oval pit with shallowly sloping sides and flat base (0.6 x 0.53m; major axis W/E). Fill: light brown with urned (1) cremation burial placed centrally, dish (2) forms lid impacted into urn.

**Cremated human bone** Infant–juvenile (3–6 years); unsexed. Wt. 8.1g.

### Grave goods

- 1\* B01. Wt. 400g. RE 30, BE 85 (BC/KB). A complete profile from a BB1 jar with everted rim, its diameter not exceeding that of the girth, with an obtuse lattice zone on the girth with a groove above, sooted and some sherds moderately burnt. *Cf.* Gillam (1976) nos 7–8, early to mid third-century. *c.* A.D. 240–70.
- 2\* S30. Wt. 375g. RE 52, BE 100 (BC/KC). Fifty-seven small fragments making up the greater part of a dish of form 31 (Sa), East Gaulish, stamped C•AT•VLLV, with an (?accidental) diagonal stroke before the C. The footring shows only slight wear, but the inside of the dish is heavily worn. The style of the lettering is not a Rheinzabern one and it is likely that this piece is the work of Catullus vi (Die 2a); one of his stamps, from a different die, occurs on a waster at Trier (Frey 1993, 26, no. 64).

### Finds of uncertain status

- 3\* ?O01. Wt. 150g. BE 38 (BC/KB). Five joining fragments from the base of an oxidised jar or constricted-necked jar.
- 4 S30. Wt. 2g. BE 16. S30. An East Gaulish footring (Rheinzabern or Argonne). Late

second or third-century. NB This fragment may have come from 26.

**Interpretation** Urned cremation burial.

## 28 1967/161 PHASE 2

Plan FIG. 4.2; details FIG. 4.27.

**Description.** Oval pit with shallowly sloping sides and slightly curved base (0.8 x 0.48m; major axis NW/SE). Fill: light brown with urned cremation burial (1) in NW end with jar (2) to SE, both vessels covered by platter (3) impacted into tops of the vessels, presumably by weight of machine.

**Cremated human bone** Adult (18–100 years); unsexed. Wt. 88.2g.

### Grave goods

- 1\* B01. Wt. 225g. (BC/KJ). Two rim fragments and 19 bodysherds from the wall of a BB1 jar decorated with an obtuse lattice zone with a groove above. *c.* A.D. 240+.
- 2\* B01. Wt. 375g. RE 32, BE 14 (BC/KL). Six rimsherds, 103 bodysherds and a base fragment from a BB1 jar with a strongly everted rim with an obtuse lattice zone on the girth with a groove above. Perhaps *cf.* Gillam (1976) nos 9–14, later third to mid fourth-century. *c.* A.D. 250–330.
- 3\* B01. Wt. 850g. RE 87, BE 100 (BC/KK). A complete BB1 simple-rimmed dish with intersecting arc decoration on the exterior wall and intersecting circles on the base. *c.* A.D. 200–350.

**Interpretation** Urned cremation burial.

## 29 1967/180 PHASE 3

Plan FIG. 4.2; details FIG. 4.28.

**Description** Oval pit with steeply sloping sides and flat base (0.46 x 0.38m; major axis N/S). Fill: layer of cremation debris in base of pit with urned cremation burial (5) and accessory vessels (6–8) placed on this; upper fill light brown. NB the fragments from the two jars (6 and 7) were recorded on site as being a single vessel. It is not now clear whether cremation (ii) was originally in one of these or both.

**Cremated human bone** Two groups from one individual. (i) from jar (5), (ii) from jar (6–7).

- (i) Adult (30–45 years); unsexed. Wt. 453.8g (including 8.7g worked bone). Pathology: Schmorl's – 1T.
- (ii) Adult (18–100 years); male. Wt. 95.7 (including 7.7g worked bone). Charcoal-stained.

**Charcoal** *Fraxinus* sp. from (5).

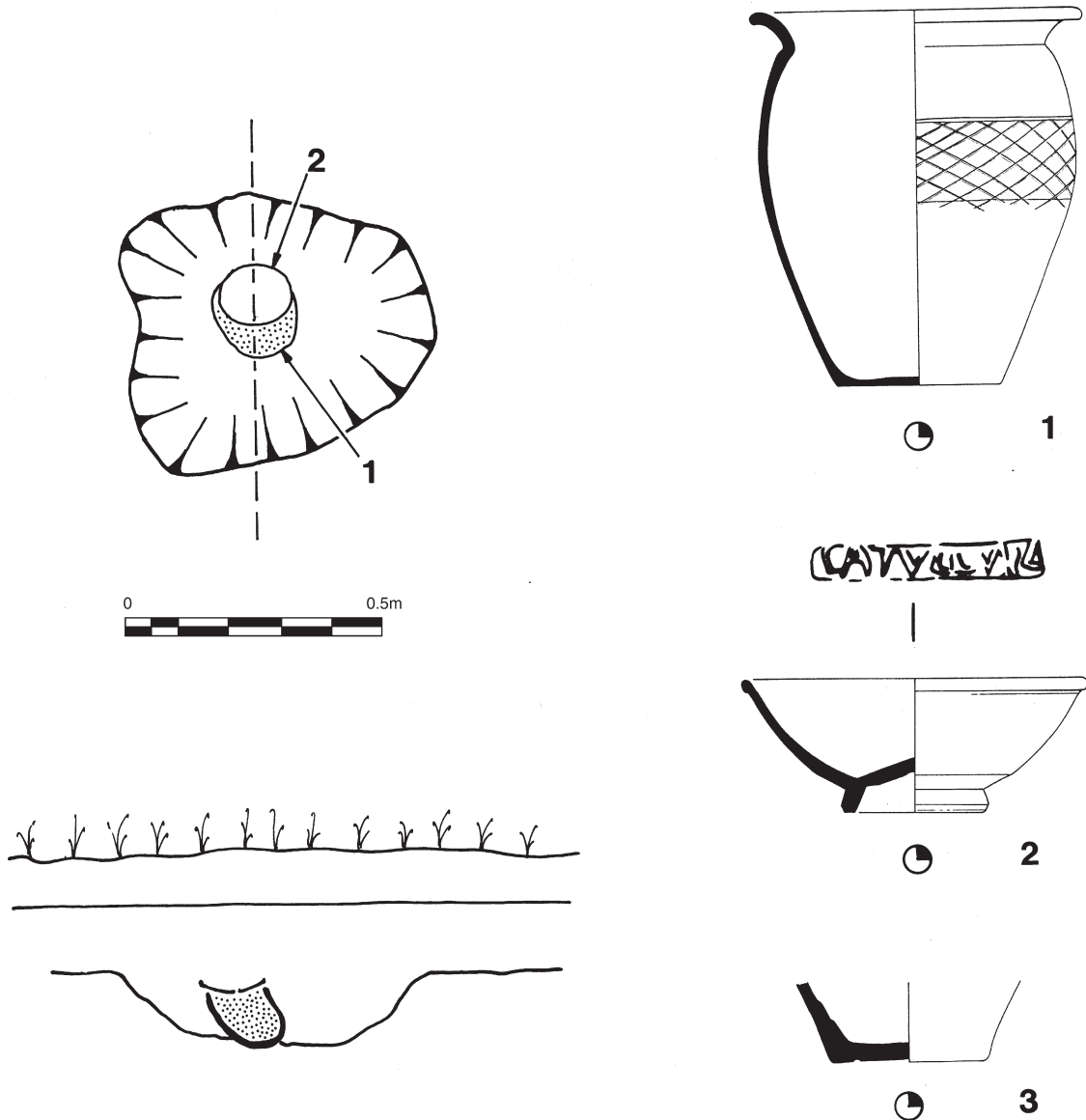

FIG. 4.26 Plan, section, grave goods and jar (3) of uncertain status from urned cremation burial 27.

**Pyre goods**

- 1 Iron; nail shank from cremated bone.
- 2 Iron; nail (21 plus fragments including uncorroded examples) from jar (5).
- 3 Iron; nail (17) from jar (6-7).
- 4 Bone veneer types: A1.1; A7.1; B1.1; C2.1; D1.2; E2.1; E2.4.

**Grave goods**

- 5\* B01. Wt. 750g. RE 10, BE 21 (BC/LO). Sherds giving the profile of a BB1 jar with everted, rising rim of smaller diameter than the maximum girth which has an obtuse lattice zone on it with a groove above, exterior sooted, interior has some traces of limescale or other calcareous deposits. Cf. Gillam (1976) nos 9-10, mid to later third-century.
- 6\* B01. Wt. 340g. RE 40, BE 100 (BC/LP(A)). A large proportion of a BB1 jar with everted

rim of similar diameter to the maximum girth and obtuse lattice decoration on the girth with a groove above. Cf. Gillam (1976) nos 10-11, later third to early fourth-century. c. A.D. 260-300.

- 7\* B01. Wt. 310g. RE 31, BE 100 (BC/LP(B)). A complete profile of a small BB1 jar with everted rim of similar diameter to the maximum girth with obtuse lattice zone on the girth with a groove above. Cf. Gillam (1976) no. 10, later third-century. c. A.D. 260-300.

(Also: B01. Wt. 13g. (BC/LQ). Five jar bodysherds probably from one of the jars in this grave.)

- 8\* B01. Wt. 622g. RE 100, BE 100 (BC/LQ). A complete BB1 developed beaded-and-flanged bowl with intersecting arc decoration on exterior. c. A.D. 270-350.

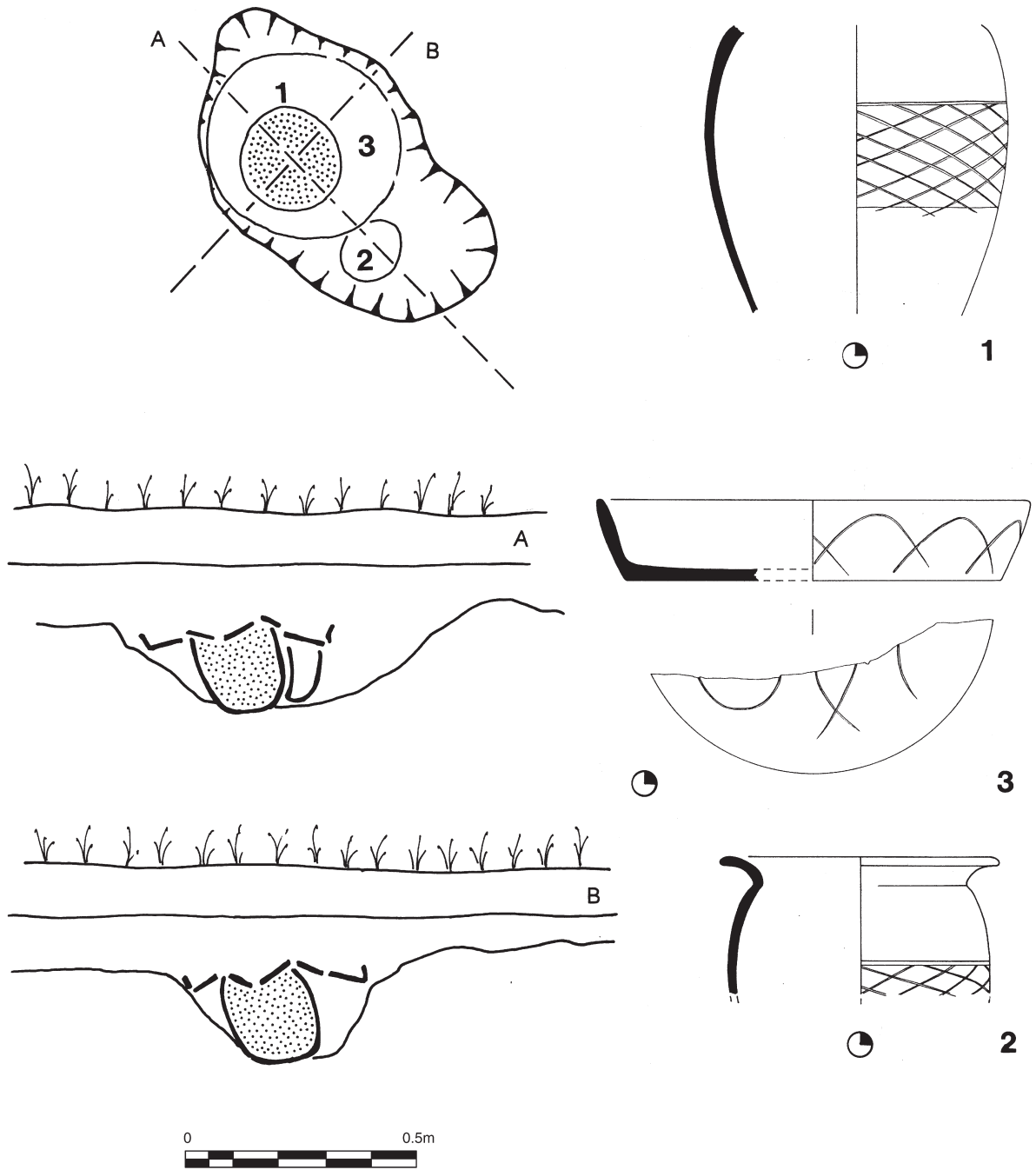

FIG. 4.27 Plan, section and grave goods from urned cremation burial 28.

**Finds of uncertain status**

9 ?R03. Wt. 6g (BC/LP(B)). A greyware body sherd.

**Interpretation** Urned cremation burial.

**30 1967/227 UNPHASED**

Plan FIG. 4.2; details FIG. 4.29.

**Description** Sub-circular pit with irregularly sloping sides, steepest to N (0.48 x 0.46m). Fill: light brown with tip of bone and charcoal in northern part. No material collected.

**Interpretation** Redeposited pyre debris.

**31 1967/142 PHASE 2**

Plan FIG. 4.2; details FIG. 4.30.

**Description** Circular pit with steep sides and flat base (0.27 x 0.25m). Fill: light brown with urned cremation burial centrally; truncated by plough or machine.

**Cremated human bone** Infant-juvenile (1-8 years); unsexed. Wt. 5.2g.

**Charcoal** *Betula* sp. (\*).

**Grave goods**

1 B01. Wt. 310g. BE 42 (BC/JK). Seventy-nine sherds from the lower wall and base of a



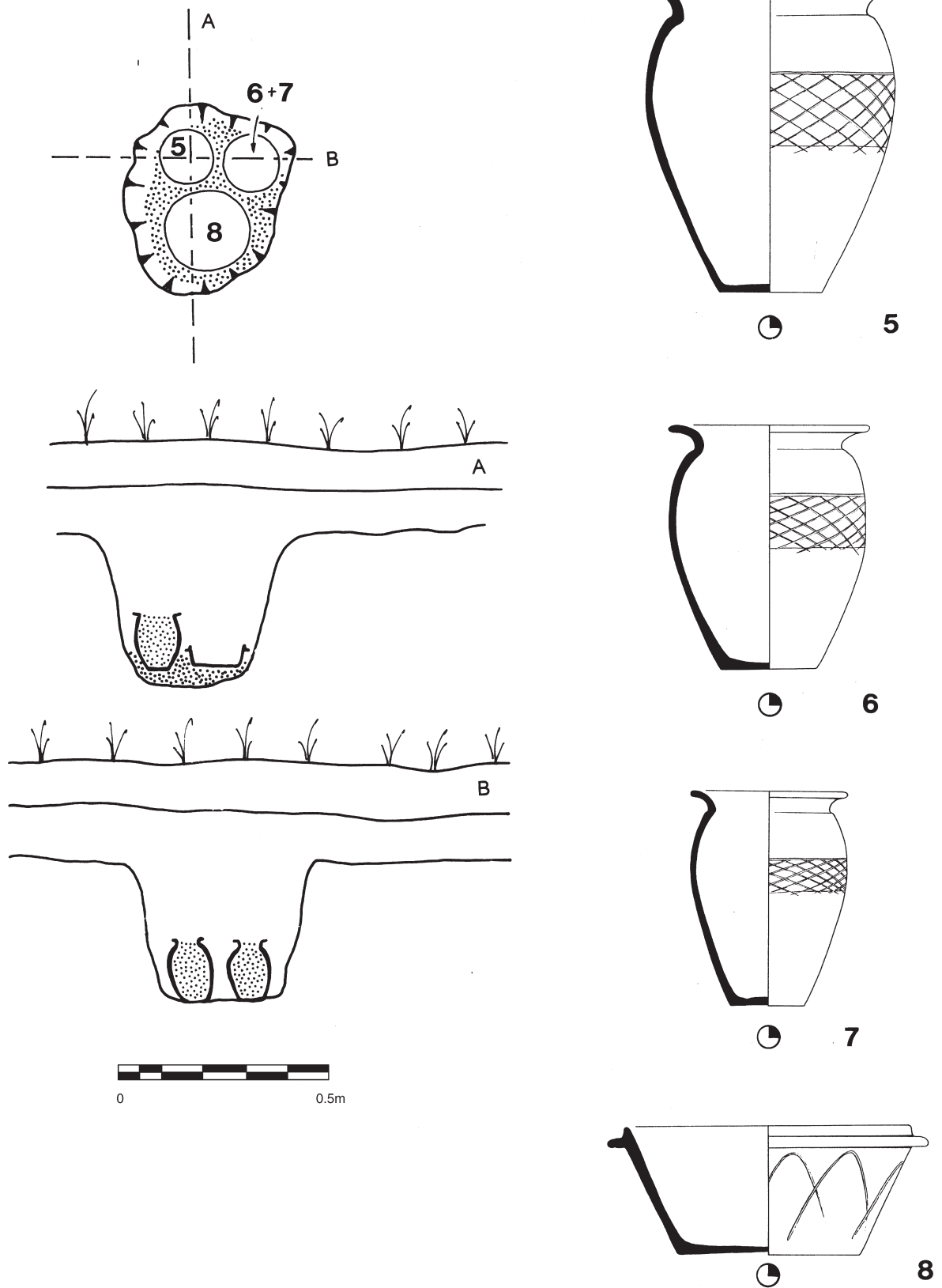

FIG. 4.28 Plan, section and grave goods from urned cremation burial 29.

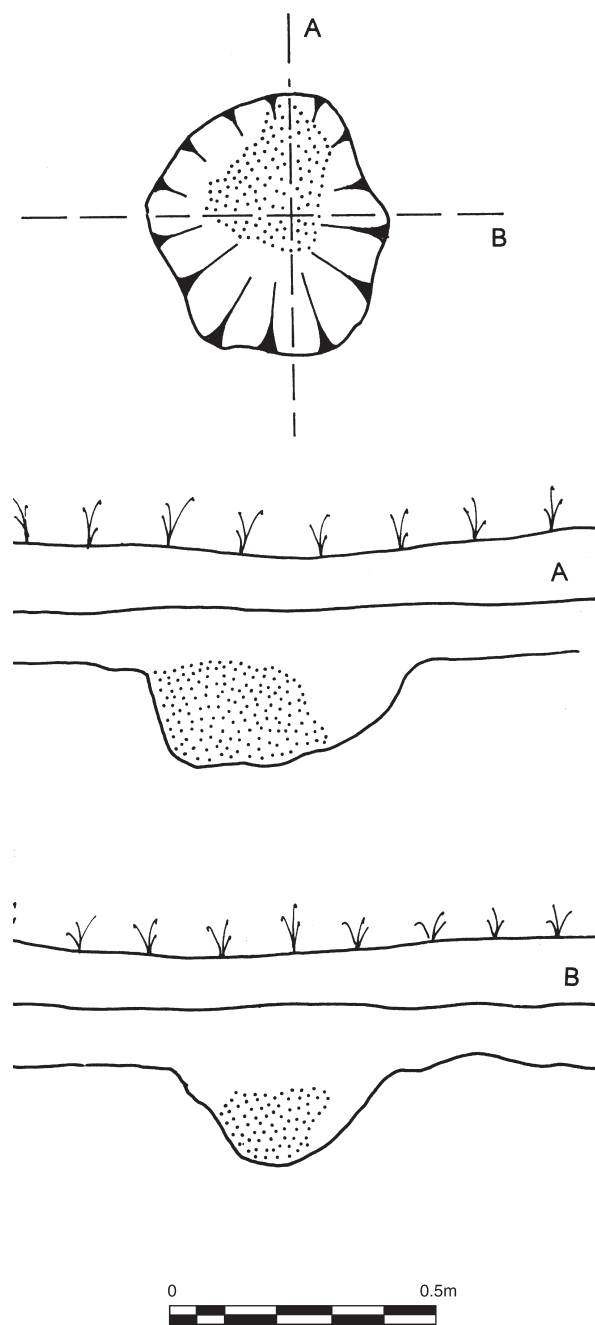

FIG. 4.29 Plan and section of pyre debris deposit 30.

BB1 jar with obtuse lattice decoration with groove above. Six sherds are heavily burnt.  
c. A.D. 240+.

**Interpretation** Urned cremation burial.

### 33 1967/217 PHASE 3

Plan FIG. 4.2; details FIG. 4.31.

**Description** Circular pit with steep sides and flat base (diameter 0.48m). Fill: light brown with fragmented urn and cremation debris in northern half of pit. Relationships: cuts F38.

**Cremated human bone** Adult (18–100 years); unsexed. Wt. 21.4g. Worn appearance.

**Charcoal** *Populus / Salix* sp. (x).

*Betula* sp. (x).

#### Pyre goods

1 Bone veneer type: E2.1.

#### Grave goods

2\* B01. Wt. 310g. RE 30, BE 95 (BC/NG). Sherds forming a jar profile with everted rim which has a greater diameter than the maximum girth and an obtuse lattice zone. It is impossible to determine if there was a groove above this; the whole vessel is heavily burnt orange. Cf. Gillam (1976) nos 10–11, later third to early fourth-century. Probably later third-century.

#### Finds of uncertain status

3 ?R08. Wt. 3g. Bodysherd.

**Interpretation** Probably urned cremation burial.

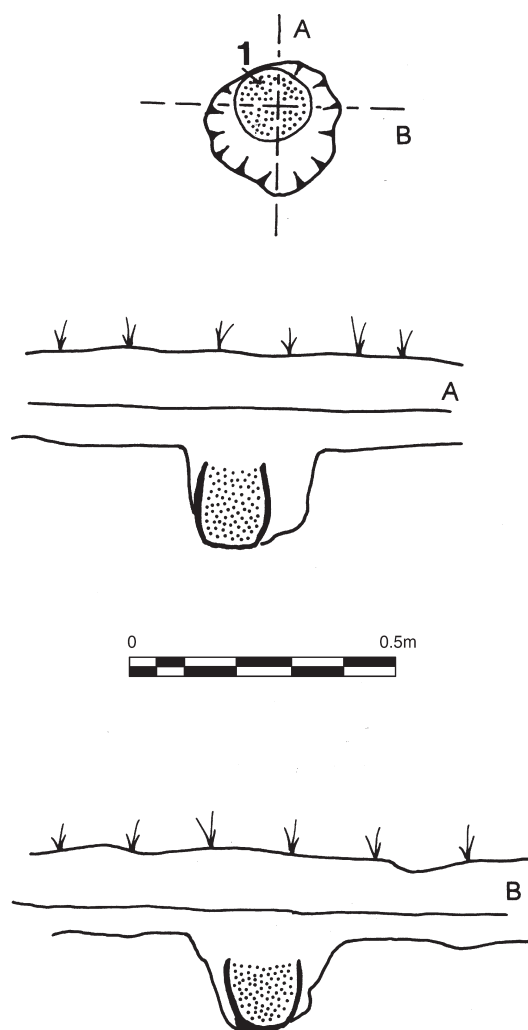

FIG. 4.30 Plan, section and grave goods from urned cremation burial 31.

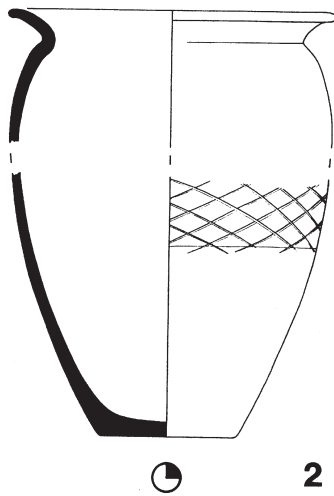
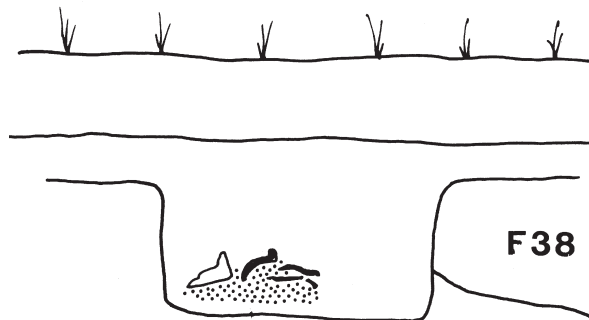
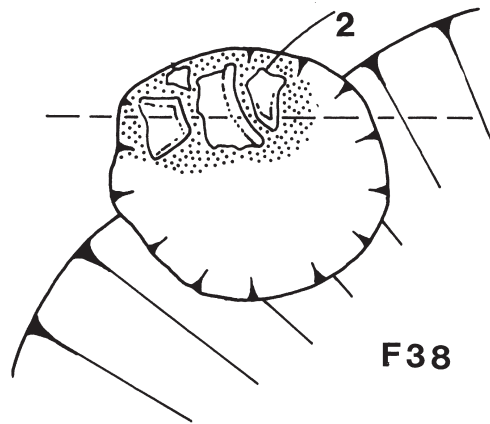

FIG. 4.31 Plan, section and urn from possible urned cremation burial 33.

### 34 1967/211 PHASE 1

Plan FIG. 4.2; details FIG. 4.32.

**Description** Oval pit with shallowly sloping sides and flat base (0.55 x 0.38m; major axis SW/NE). Fill: light brown with scatter of cremation bone and charcoal with sherds of (1), possibly truncated. Relationships: cut into F38.

**Cremated human bone** None collected.

#### Grave goods

1\* O01. Wt. 140g. RE 18 (BC/MZ). Sherds from a constricted-necked jar with hooked rim. Second to third-century.

**Interpretation** Possibly urned ?cremation burial but uncertain as material recorded does not survive in archive and may not have been collected.

### 35 1967/224 PHASE 1

Plan FIG. 4.2.

**Description** ?Circular pit (diameter 0.67). Fill: light brown with scatter of cremated bone shown on plans as separate from 'considerable spread of pottery sherds' though description states they were found 'together with' pottery. Sandstone slab lying to one side.

**Cremated human bone** Adult (30–45 years); unsexed. Wt. 260.7g (including 5.5g animal bone and 0.5g worked bone). Pathology: amlt – maxillary left I1; exo – iliac crest.

**Cremated animal bone** Large ungulate, small ungulate, bird.

#### Pyre goods

1 Iron: nail (4).  
2 Bone veneer type: A7.  
3 S20. Wt. 6g. (BC/NL). A burnt fragment of form 37. Central Gaulish. The large double-bordered medallion or arcade with dancer (D.216 = O.353) has parallels in the work of Do(v)eccus and Iullinus ii, which suggests a date in the range A.D. 160–200.

#### ?Grave goods

4 'Hard fired flagonware sherds' – now missing.

**Interpretation** Majority of pottery now missing; this *may* have been an urned cremation with a sandstone slab lid.

### 36 1967/194 PHASE 1

Plan FIG. 4.2; details FIG. 4.33; see also FIG. 2.2.

**Description** Cist in steep-sided rectangular pit, sides lined with sandstone slabs with northern slab

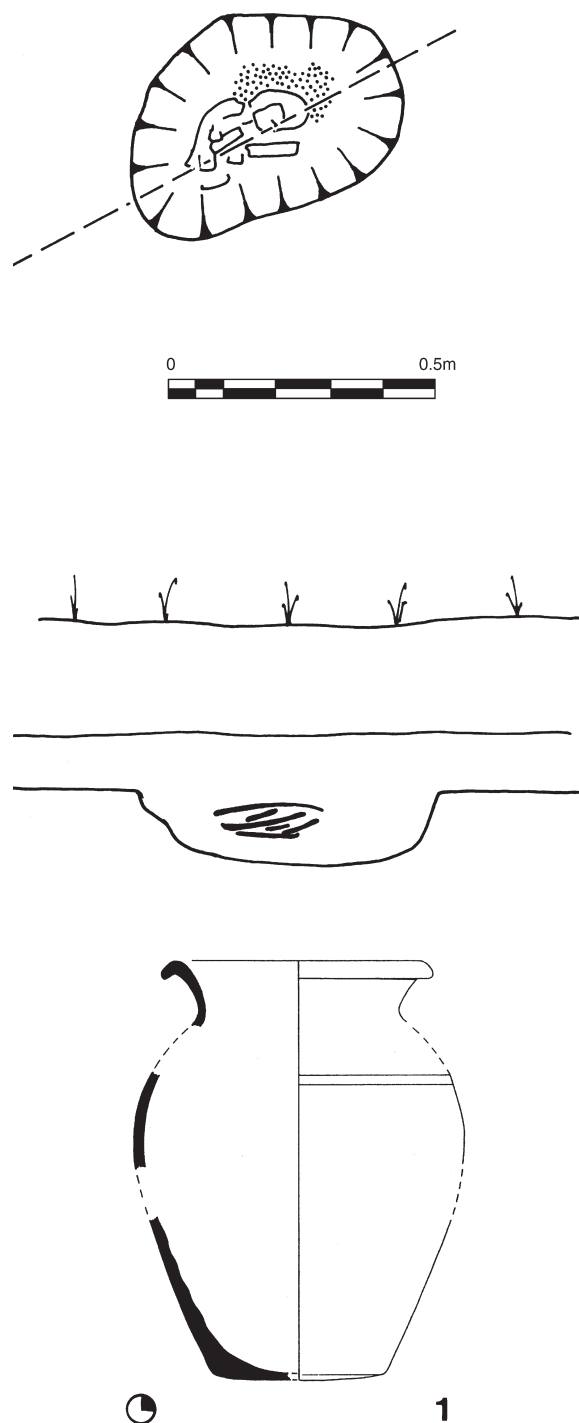

FIG. 4.32 Plan, section and urn from possible urned cremation burial 34.

displaced into central part of cist, capping slab partially collapsed into top of cist (0.61 x 0.46m; major axis N/S). Fill: light brown with intact pottery vessels. Flagon (8) placed in dish (7) in NW corner, beaker (2) placed on (6) in SW corner; beaker (3) with cremated bone in SW corner; beakers (4 and 5) on southern side.

**Cremated human bone** Two groups from two individuals cremated separately. (i) from dish (6), (ii) from beaker (3).

- (i) Adult (30–45 years); unsexed. Wt. 246.5g (including 0.4g animal bone and 4.8g worked bone). Pathology: amtl – 1 mandibular; pitting – C ap.
- (ii) Infant (3–4 years); unsexed. Wt. 22.7g (including 0.2g animal bone).

**Cremated animal bone** Small ungulate, bird.

#### Pyre goods

- 1 Iron: nail (4 including shank fragment adhering to cremated bone) from (2).

#### Grave goods

- 2\* F03. Wt. 300g. RE 100, BE 100 (BC/MBb). A complete bag beaker with a simple rim with groove beneath with barbotine hunt scene of dogs pursuing a hare. *c.* A.D. 160/70–250. (FIG. 8.17).
- 3\* F03. Wt. 290g. RE 100, BE 100 (BC/MBc). A complete bag beaker with a simple rim, groove on the shoulder and barbotine scroll decoration beneath. *c.* A.D. 160/170–250.
- 4\* F03. Wt. 55g. RE 90. BE 100 (BC/MBe). A complete small cornice-rimmed bag beaker in Nene Valley colour-coated ware. *Cf.* Howe *et al.* (1980) nos 26 and 28–30, later second to mid third-century.
- 5\* F03. Wt. 78g. RE 100, BE 100 (BC/MBd). A complete small Nene Valley colour-coated ware indented beaker with a simple rim. *Cf.* Howe *et al.* (1980) nos 42–3, mid to later third-century; Perrin (1999) 94, *c.* A.D. 225–300.
- 6\* B01. Wt. 460g. RE 100, BE 100 (BC/MBg). A complete BB1 incipient beaded-and-flanged bowl with intersecting arc decoration and intersecting circles on the base, sooted. *Cf.* Gillam (1976) nos 43–4, early to mid third-century.
- 7 A dish described as coarse greyware, Gillam 330, with graffito of V. Recorded but now missing.
- 8\* W02. Wt. 350g. RE 100, BE 100 (BC/MBa). A complete, unbroken, pear-shaped flask with everted rising rim and cordoned shoulder with red paint bands on the body in Nene Valley parchment ware. Second to third-century. (FIG. 8.13).

#### Other finds

- 9\* Glass; bead. Gold-in-glass; slightly squashed spherical. Section 5.5mm, L. 4.5mm, perforation diameter 1mm (in fill). Late second to fourth-century.

**Interpretation** Urned cremation burial of two individuals cremated separately.

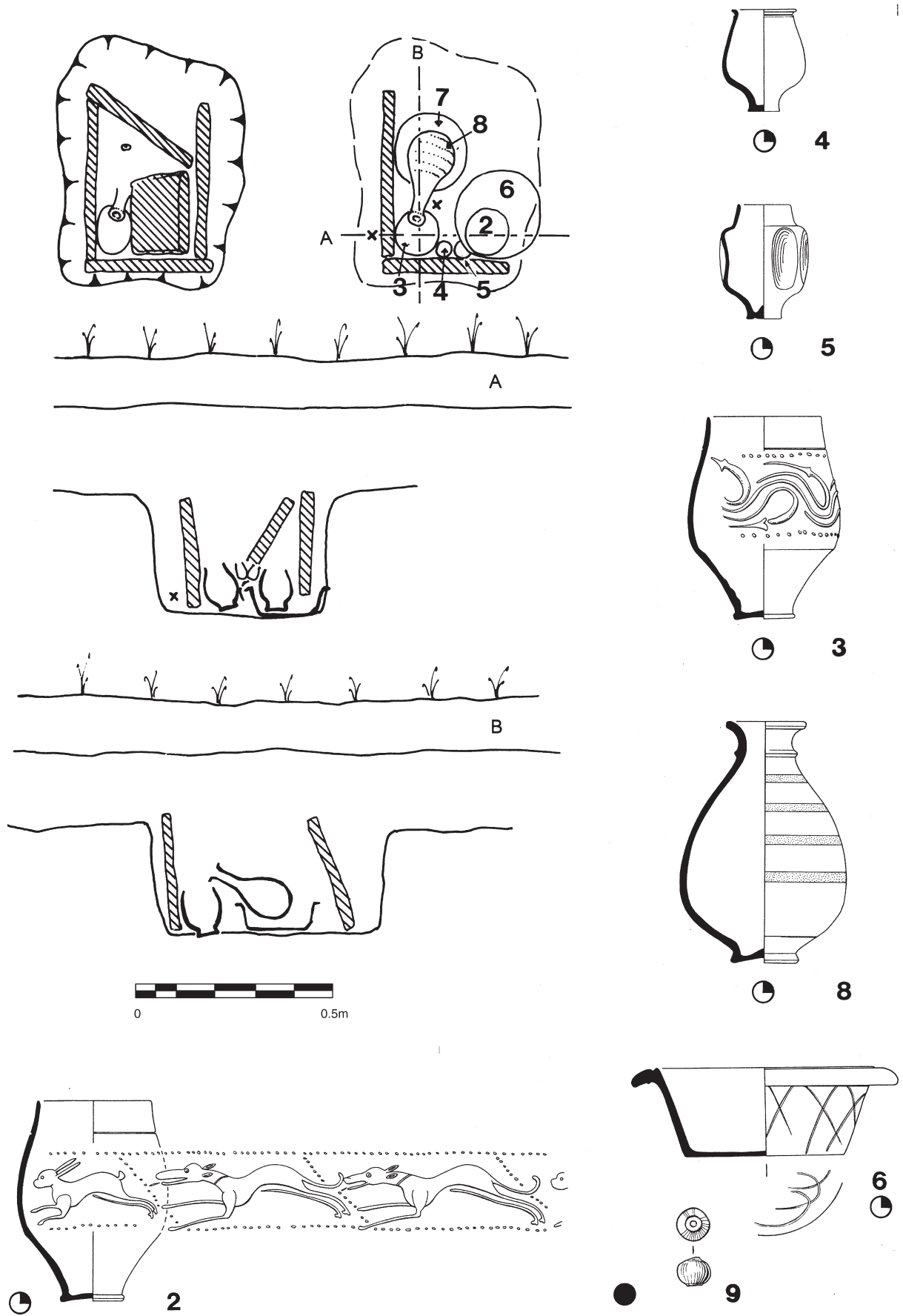

FIG. 4.33 Plan, section and grave goods from urned cremation burial 36.

## 37 1967/216 PHASE 2

Plan FIG. 4.2; details FIG. 4.34.

**Description** Rectangular pit; shape unknown (0.57 x 0.48m; major axis N/S). Fill: dark brown/black with diagonal band of sherds and cremation debris; probably truncated and spread by plough. Original records describe (2) as being inverted over cremated bone. Relationships: cuts **F38**.

**Cremated human bone** Adult (18–100 years); unsexed. Wt. 35.9g.

**Charcoal** *Populus/Salix* sp. (x).  
*Alnus* sp (x).

**Pyre goods**

1 Iron; nail possibly from cinerary urn.

**Grave goods**

2 R07. Wt. 450g. RE 72, BE 15 (BC/NE). A greyware BB-copy jar with dark grey slip, with everted rim and obtuse lattice zone on the body. Probably early to mid third-century. *c.* A.D. 200/220–270.

3\* F03. Wt. 140g. RE 23, BE 100 (BC/NF). An indented Nene Valley beaker with vertical grooved rim. *Cf.* Gillam (1970) types 52 and 54, A.D. 250–300; Howe *et al.* (1980) nos 42–3, mid to later third-century; Perrin (1999) 94, *c.* A.D. 225–300.

**Interpretation** Urned cremation burial.

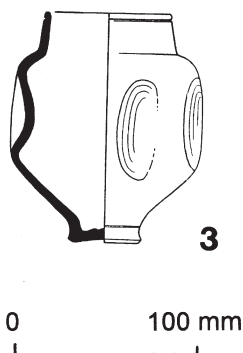

FIG. 4.34 Beaker from urned cremation burial 37.

## 38 1967/237 PHASE 1

Plan FIG. 4.2; details FIG. 4.35.

**Description** Rectangular pit; shape unknown (1.22 x 0.7m; major axis N/S). Fill: dark brown/black with pyre goods, ash and charcoal spread throughout. Relationships: dug into **F37**.

**Cremated human bone** Subadult–adult (13–100 years); unsexed. Wt. 0.8g.

**Pyre goods**

1 Iron; hobnail.

2 S20. Wt. 52g. RE 2, BE 25 (BC/OS). Four fragments, possibly all from the same form 31, Central Gaulish, to judge by the shape.

Heavily burnt and molten glass has trickled onto the fragments, which include one with a moderately worn footring. Late second-century. A.D. 160–200.

3\* S30. Wt. 5g (BC/OS). Form 37 body fragment, heavily burnt, East Gaulish. The bowl carries the stamp COM[ITIL ISF] retrograde (Die 5c) in sunken letters on a raised label (Ludowici 1927, 240, d). *Cf.* Ricken 1948, Taf. 91 for examples of medallions combined with plant fronds. This particular medallion is Ricken and Fischer 1963, K20A. Comitialis worked at Rheinzabern in the late second or early third century. A bowl from a mould stamped with this die is known from Niederbieber. *c.* A.D. 180–220.

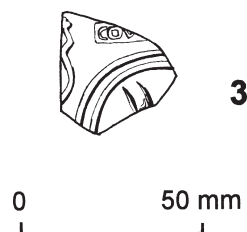

FIG. 4.35 Stamped decorated samian sherd from pyre debris deposit 38.

4 S30. Wt. 12g. RE 3 (BC/OS). Form 37 rim fragment, heavily burnt. Possibly from the same vessel as 38.3.

5 S30. Wt. 12g. Form 37 fragment, heavily burnt East Gaulish. The decoration includes a double medallion containing a figure. Probably Rheinzabern ware.

**Finds of uncertain status**

6 B01. Wt. 14g. (BC/OS). A BB1 dish/bowl wall bodysherd. Hadrianic to mid fourth-century.

7 B01. Wt. 80g. RE 20, BE 26 (BC/OS). Three rim fragments, three base fragments and ten bodysherds from a BB1 jar with obtuse lattice decoration. *Cf.* Gillam (1976) nos 5–7, later second to early third-century. *c.* A.D. 200–40.

8 B01. Wt. 115g. RE 18, BE 20. Twelve sherds from a BB1 simple-rimmed dish with intersecting arc decoration on exterior and intersecting circles on the base. *c.* A.D. 200–350.

9 ?R06. Wt. 10g. A greyware bodysherd from a jar with horizontal rouletted lines.

10 ?R12. Wt. 10g. A greyware BB copy jar bodysherd with acute burnished lattice decoration. Perhaps Hadrianic to Antonine.

11 ?O05. Wt. 5g. An oxidised bodysherd.

12 R10. Wt. 85g. BE 17. Seven sherds from the lower wall and base of a greyware jar.

- 13 F03. Wt. 160g. Sherds from a simple-rimmed or cornice-rimmed bag beaker with barbotine scroll decoration in Nene Valley colour-coated ware. Cf. Howe *et al.* (1980) nos 26–30 and 44–5. c. A.D. 160/170–250.
- 14 S30. Wt. 42g. (BC/OS). Part of the base of a form 37, East Gaulish. No decoration survives, but the fragment shows two very heavy basal ridges. Late second or early third-century.

**Interpretation** Redeposited pyre debris.

**39 1967/238 PHASE 2**

Plan FIG. 4.2; details FIG. 4.36.

**Description** Rectangular pit with shallowly sloping S and W sides, others steep-sided, flat base (0.57 x 0.46m; major axis N/S). Fill: spread of charcoal and cremation debris in base of pit with jar (3) placed on top; upper fill light brown.

**Cremated human bone** Juvenile–subadult (5–14 years); unsexed. Wt. 2.5g.

**Pyre goods**

- 1 Iron; nail (fragment).
- 2 Glass; vessel. Blue/green melted lump containing fragments of cremated bone (3g).

**Grave goods**

- 3\* B01. Wt. 300g. BE 90 (BC/OK). Bodysherds forming the profile of a BB1 jar with obtuse lattice zone on the girth with a groove above. Possibly some slight sooting, base and lower wall burnt orange. c. A.D. 240+.

**Interpretation** Jar (3) is described as an accessory vessel suggesting this was not an urned cremation burial. The description and finds could be interpreted as some form of vessel deposit.

**40 1967/232 UNPHASED**

Plan FIG. 4.2; details FIG. 4.37.

**Description** Circular pit with straight sides and convex base (diameter 0.4m). Fill: 'entirely composed of bone and other cremation debris'.

**Cremated human bone** Adult (30–45 years); unsexed. Wt. 111.6g. Heavily charcoal-stained.

**Interpretation** Redeposited pyre debris.

**41 1967/208 PHASE 3B**

Plan FIG. 4.2; details FIGS 4.38, 4.39.

**Description** Rectangular pit with steep sides and flat base, two sandstone slabs arranged in V-shape (0.91 x 0.63m; major axis SW/NE). Fill: light brown with row of vessels placed between slabs with urned cremation in jar (5) placed centrally,

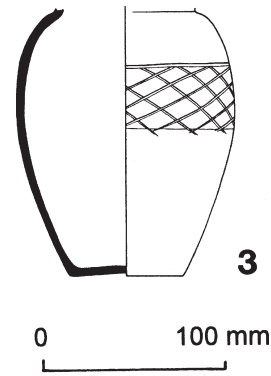

FIG. 4.36 Jar from possible vessel deposit 39.

concentration of cremation debris in NE corner; slabs possibly disturbed by machine.

**Cremated human bone** Adult (18–100 years); unsexed. Wt. 59.5g.

**Pyre goods**

- 1 Copper alloy; fragment distorted by heat; also sheet.
- 2 Lead alloy; fragments from cremated bone.
- 3 Iron; nail (5 including 2 fragments), general BC/MX–V.
- 4 Iron; nail ?in urn.

**Grave goods**

- 5\* G05. Wt. 700g. RE 12, BE 100 (BC/MV). A Dales-type jar, the lower half fairly complete, but only one fragment of the rim survives, exterior sooted.
- 6\* W02. Wt. 181g. BE 100 (BC/MX). A white-ware flagon or flask base, probably Nene Valley creamware. Second to fourth-century.

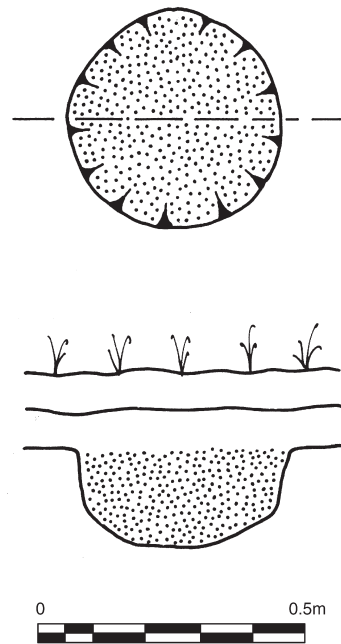

FIG. 4.37 Plan and section of pyre debris deposit 40.

7\* R04. Wt. 580g. RE 33, BE 100 (BC/MW). Fragments from a Crambeck type 1 beaded-and-flanged bowl, originally described as almost complete, but not so now. A.D. 285–400.

**Interpretation** Urned cremation, possibly with redeposited pyre debris in fill though the spread may be due to disturbance.

42 1967/207 PHASE 3B

Plan FIG. 4.2; details FIGS 4.39, 4.40.

**Description** Partial cist. Oval pit with steep sides and flat base with sandstone slabs tilted at angles on W and E sides (0.7 x 0.53m; major axis W/E). Fill: light brown with jar (3) found between pit wall and slab in NW corner. Bone and charcoal in

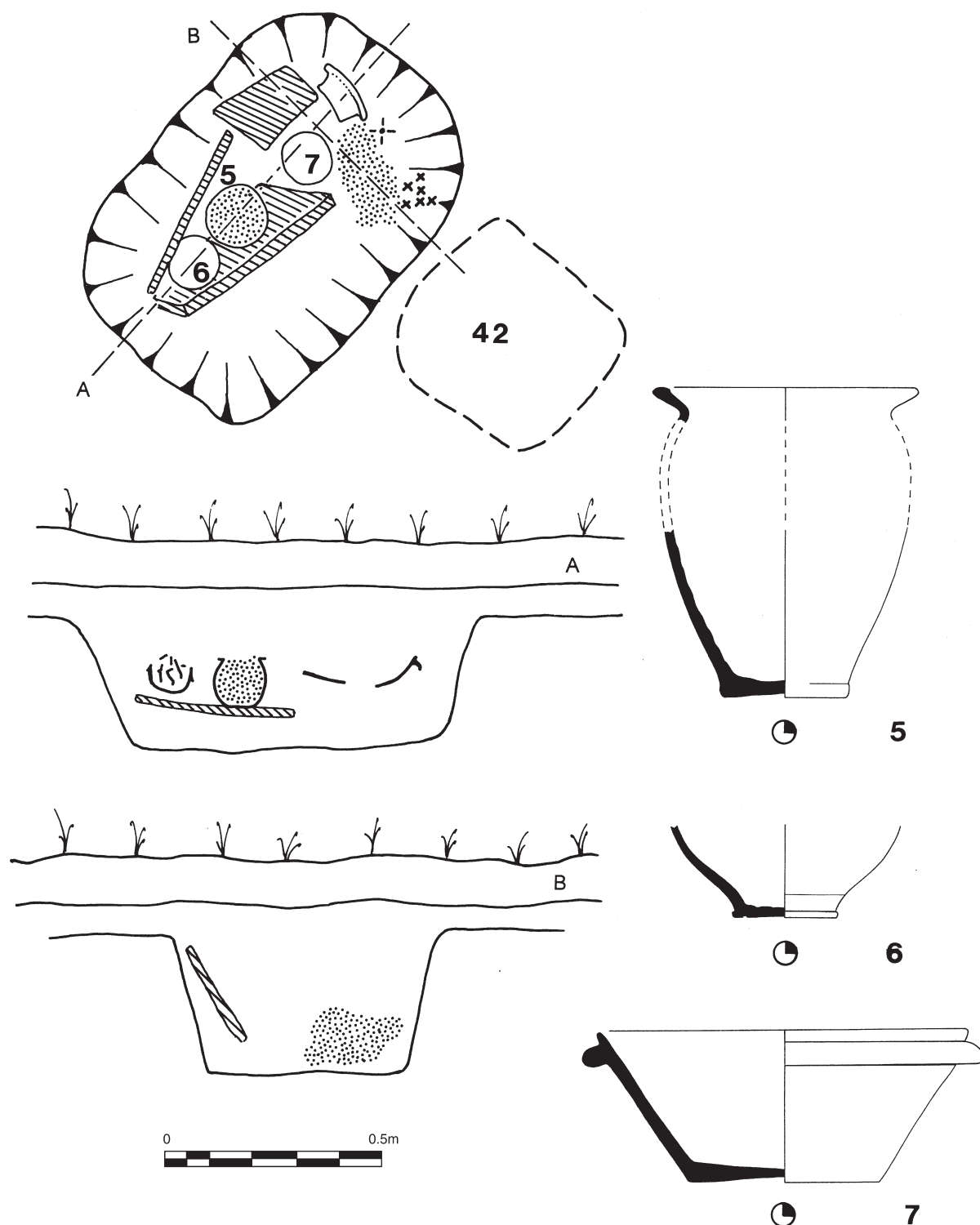

FIG. 4.38 Plan, section and grave goods from urned cremation burial 41.





FIG. 4.39 Urned cremation burial 41 in foreground with unurned burial 42 behind; scale in inches.

spread either side of eastern slab. Truncated by machine which may have displaced slabs.

**Cremated human bone** Adult (18–100 years); unsexed. Wt. 6.4g.

**Pyre goods**

- 1 Iron; nail (3).
- 2 Iron; small burnt nail found in cremated bone.

**Grave goods**

- 3\* R05. Wt. 350g. BE 100 (BC/MU). A complete greyware jar base with vertical burnished line decoration in a panel from the girth upwards. Perhaps the Catterick Crambeck-copy fabric. Early to mid fourth-century.

**Interpretation** Possibly unurned cremation burial.

**43 1967/99 PHASE 1**

Plan FIG. 4.2; details FIG. 4.41.

**Description** Feature destroyed by machine.

**?Grave goods**

- 1\* S20. Wt. 575g. RE 75, BE 26 (BC/HL). About two-thirds of a bowl of form 37 from a mould stamped [DOIC]CVS retrograde (Die 13a), upside down among the decoration (Stanfield and Simpson 1958, pl. 147, 2). This stamp was commonly used on plain samian but is one of the rarer stamps on decorated ware. However, it is on form 37 at Benwell, South Shields, and in the Newcastle Museum (presumably from Hadrian's Wall). The positive impression of the stamp is on plain ware at Benwell, Chesterholm, Wallsend and twice at Haltonchesters. Scroll decoration is not common in Do(v)eccus's work, but a similar, though less elaborate, design occurs on a stamped bowl from London (Stanfield and Simpson 1958, pl. 147, 7). The ovolo is Rogers B161, the polygonal leaf a smaller

version of Rogers J1 with much finer beading around the edge, the heart-shaped leaf Rogers J16, the pointed leaf Rogers H152, the trifid motif Rogers G225, the beaded ring Rogers E58 and the *cantharus* Rogers T14. The heart-shaped leaf is only used once in place of the large polygonal leaf. The footring is well worn. c. A.D. 165–200.

**Interpretation** None possible.

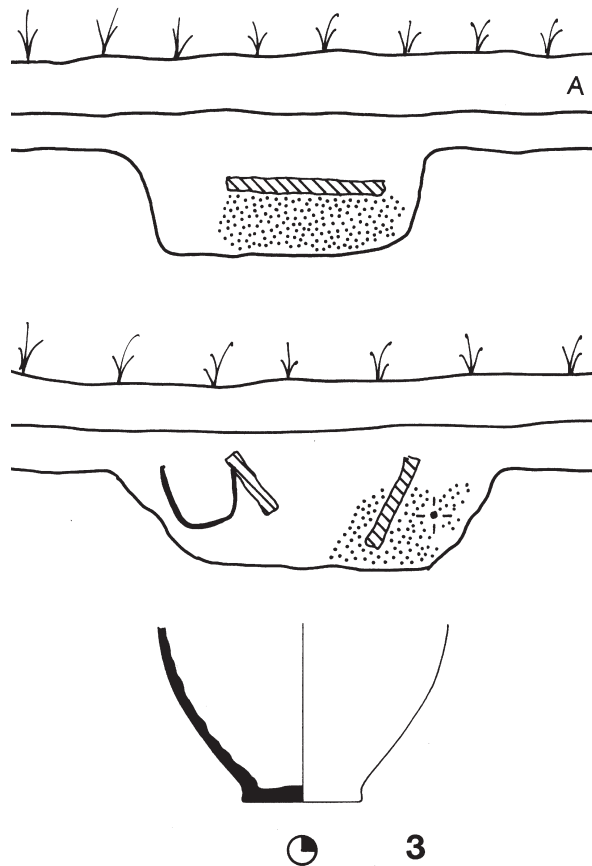
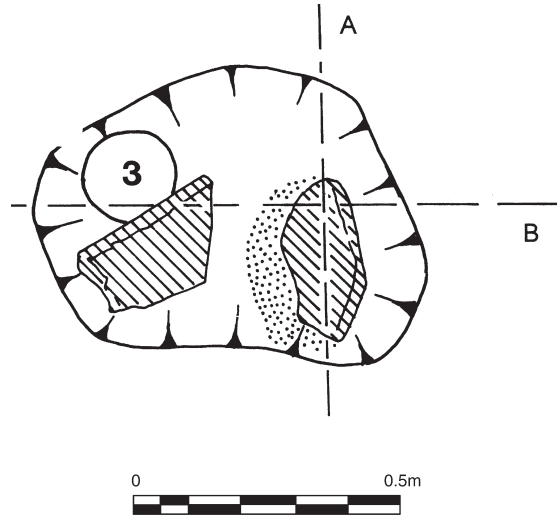

FIG. 4.40 Plan, section and grave goods from unurned cremation burial 42.

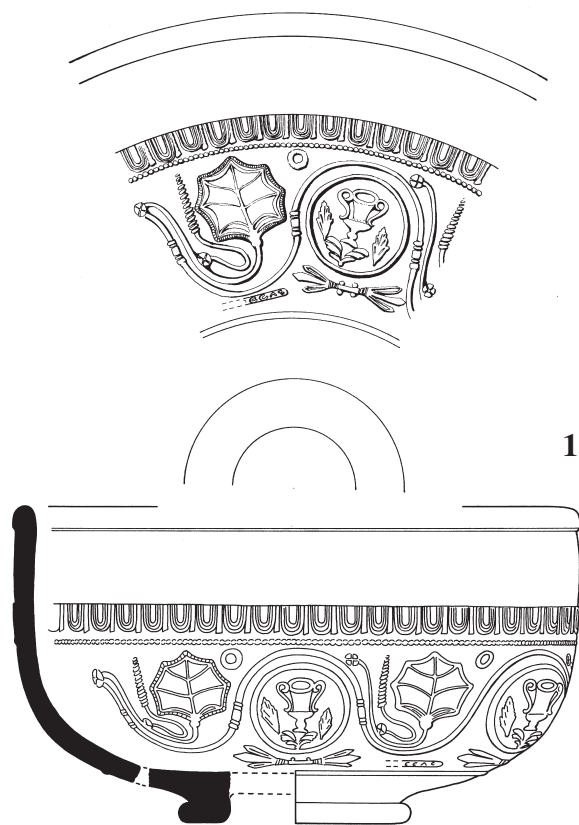

FIG. 4.41 Form 37 from deposit 43.

**44 1967/89 PHASE 1**

Plan FIG. 4.2.

**Description** No detailed description survives. Described as 'rectangular pit 1'10" x 2' x 5" deep' (0.56 x 0.61 x 0.13m).

**Cremated human bone** Subadult–adult (13–100 years); unsexed. Wt. 1g.

**Finds in fill**

- 1 R03. Wt. 6g. (BC/GO). Eight greyware bodysherds from a jar with ?acute burnished lattice decoration. ?Hadrianic to Antonine.

**Interpretation** None possible.

**45 1967/203 PHASE 2**

Plan FIG. 4.2; details FIG. 4.42.

**Description** Oval pit with steep sides and slightly rounded base (0.59 x 0.48m; major axis N/S). Fill: light brown with fragmented vessel and cremation debris placed slightly off-centre to E with plough scatter to SW. Sandstone slab to W. Truncated by ploughing.

**Cremated human bone** Subadult–adult (13–100 years); unsexed. Wt. 10.3g.

**Grave goods**

- 1 B01. Wt. 45g. RE 16 (BC/MQ). Sixty-two sherds from a BB1 jar with everted rim, many burnt and some sooted, with obtuse lattice zone on the girth with a groove above. c. A.D. 250–350.

**Interpretation** Urned cremation burial.

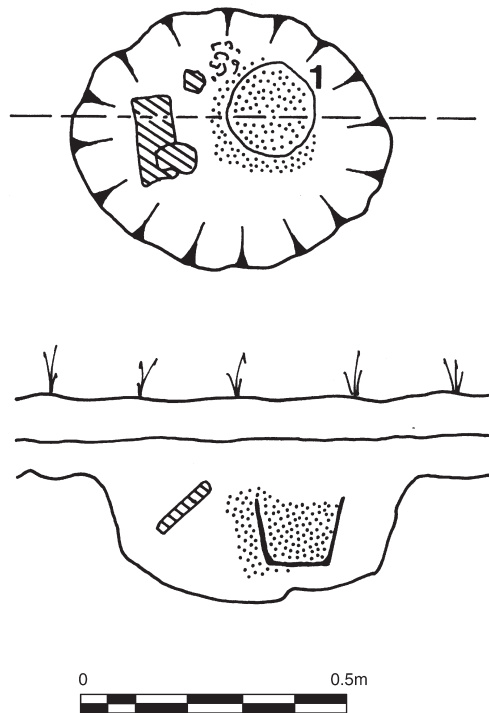

FIG. 4.42 Plan and section of urned cremation burial 45.

**46 1967/192 PHASE 1**

Plan FIG. 4.2; details FIG. 4.43.

**Description** No detailed description survives; described as 'damaged cist' but drawn evidence shows no sign of sandstone slabs. Oval shallow pit (0.61 x 0.48m; major axis NE/SW). Fill: crushed urn (2) found in horizontal position on NW side. Probably truncated.

**Cremated human bone** Juvenile–adult (5–100 years); unsexed. Wt. 4.6g.

**Pyre goods**

- 1 Bone veneer type: A7.1.

**Grave goods**

- 2 B01. Wt. 250g. RE 23, BE 38 (BC/LZ). Four rim fragments, three base sherds and 44 bodysherds from a BB1 jar, many base and lower wall sherds are heavily burnt. Cf. Gillam (1976) no. 7, early to mid third-century. Possibly c. A.D. 200–230.

**Interpretation** Urned cremation burial.

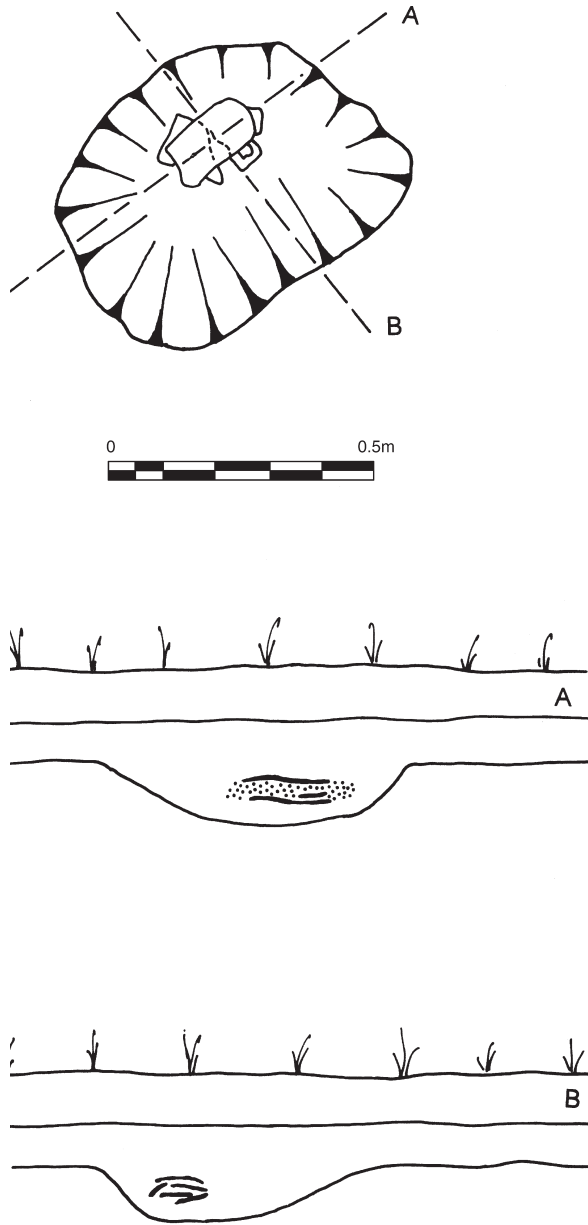

FIG. 4.43 Plan and section of urned cremation burial 46.

47 1967/191 PHASE 1

Plan FIG. 4.2; details FIG. 4.44.

**Description** Triangular cist placed in eastern side of oval pit (0.63 x 0.53m; major axis W/E): Fill: light brown with bone and charcoal at base of cist and outside of cist by N wall of pit. Beaker (1) in W corner of cist described as 'filled with bone and charcoal'.

**Cremated human bone** Infant (0-4 years); unsexed. Wt. 0.2g.

**Charcoal** *Betula* sp. (\*).

**Grave goods**

1\* F04. Wt. 255g. RE 80, BE 100. A fairly complete beaker, just missing part of the

rim. Cf. Gillam (1970) types 47-8, in Central Gaulish Rhenish ware, c. A.D. 150-200.

**Interpretation** Urned cremation burial probably with redeposited pyre debris in fill. NB Much of the cremation debris either not collected or does not survive in archive.

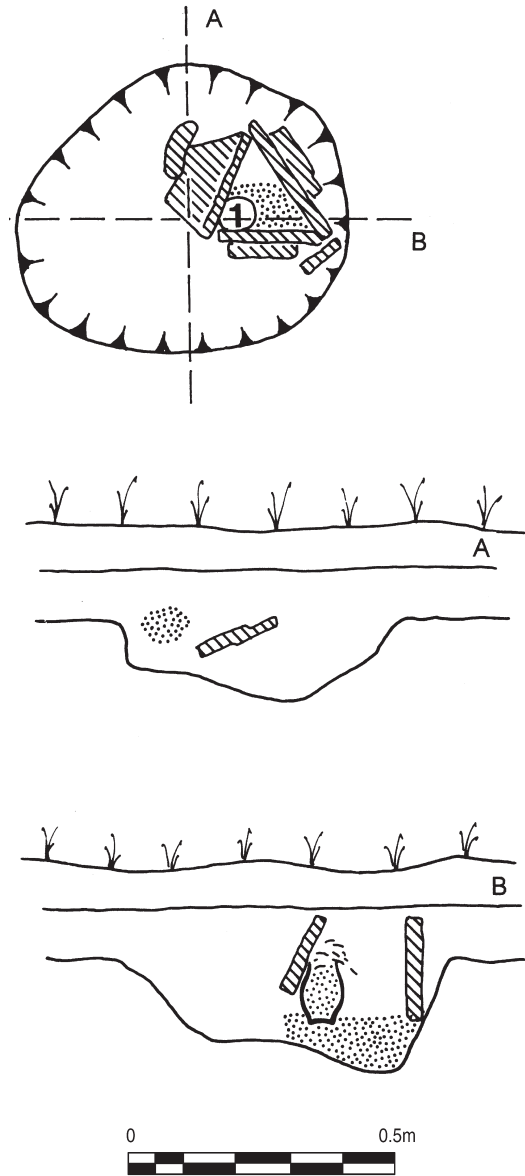

FIG. 4.44 Plan, section and urn from urned cremation burial 47.

## 48 1967/187 PHASE 2

Plan FIG. 4.2; details FIG. 4.45.

**Description** Circular pit with steep sides and gently rounded base (diameter 0.28 x 0.24m). Fill: light brown with fragmented beaker (1) on SE side, beaker described as 'filled with bone and charcoal' and spread of similar material below sherds and between them and wall of pit. Truncated by ploughing.

**Grave goods**

- 1\* F02. Wt. 330g. RE 19, BE 100 (BC/LV). A Nene Valley colour-coated ware indented scale beaker. Cf. Howe *et al.* (1980) no. 39, mid to later third-century; Perrin (1999) nos 165-7, c. A.D. 225-300.

**Interpretation** Urned cremation burial. NB None of the bones or charcoal was collected.

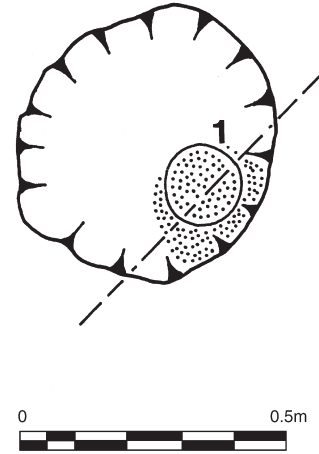

## 49 1967/188 PHASE 2

Plan FIG. 4.2; details FIG. 4.46.

**Description** Rectangular cist (0.63 x 0.47m; major axis N/S) placed in oval pit (0.74 x 0.66m). Cist wall 0.46m high at NW corner. Fill: light brown in northern part with patches of burnt bone and charcoal in NW and NE corners; greater concentrations of bone and charcoal in southern half spreading to N along E and W walls, beaker (8) placed in SE corner. Square depression in base of cist. Fill in area between cist and pit wall described as 'burnt earth, charcoal and bone'.

**Cremated human bone** Three groups from same individual. (i) found with sherds of jar (MC), (ii) from fill between cist and pit wall, (iii) from fill.

- (i) Adult (21-45 years); unsexed. Wt. 121.3g. Heavily charcoal-stained.
- (ii) Adult (21-45 years); unsexed. Wt. 66.1g (including 0.6g animal bone and 1.2g worked bone). Heavily charcoal-stained.
- (iii) Adult (25-45 years); unsexed. Wt. 9.5g. Heavily charcoal-stained.

**Cremated animal bone** Small ungulate.

**Charcoal** Three separate samples were taken. (i) and (ii) were from the fill and (iii) from fill between cist and pit wall.

- (i) *Betula* sp. (\*).
- (ii) *Betula* sp. (\*).
- (iii) *Alnus* sp. (x).
- Betula* sp. (x).

**Pyre goods**

- 1 Copper alloy; sheet fragment (8), also two fragments distorted by heat.
- 2 Iron; hobnail.
- 3 Iron; nail burnt shank fragment found in cremated bone.

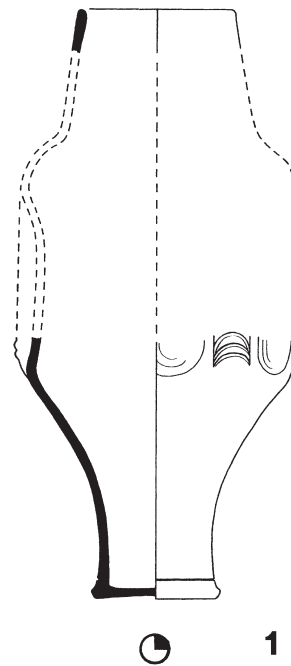
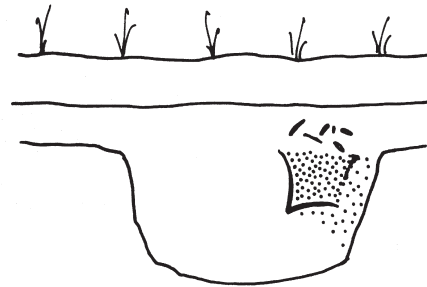

FIG. 4.45 Plan, section and urn from urned cremation burial 48.