

ROMAN VILLA AT SANDILANDS ROAD,  
WALTON-ON-THE-HILL.  
EXCAVATIONS OF 1948-49

BY

A. W. G. LOWTHER, F.S.A.

THE presence of a Roman villa at this site (that of the garden of the present bungalow named *Windmill Bank*) was first discovered during 1915, when practice trench-digging was being carried out in what was then an open field (the glebe meadow) by a detachment of the Public Schools Battalion, which was then in training in the area.

An apsidal plunge-bath, and certain other foundations, were then cut through, but no detailed excavations were then possible. Fortunately, the find was reported to Mr. Edward Yates, F.S.A., who visited the site together with the late Mr. Mill Stephenson, F.S.A., and the position of the bath was noted by them and photographs taken (here reproduced—Plate V).

The trenches were filled in and nothing further was done until 1948, when Mr. Frere, with the assistance of boys from Epsom College, commenced excavations which were continued by the writer during the winter and the spring of the following year. Though the meadow had, since 1915, been divided into two separate holdings, and a dwelling erected on the front portion of each plot, practically the whole of the villa (as the excavations showed) lay within the confines of one plot and, despite the fact that it had been laid out as a garden, by careful selection of the points at which the trenches were sited, it was possible to recover the plan of the villa fairly completely and with a minimum of damage to the garden concerned.

Amongst those volunteers who assisted with this work, a special tribute is due to the late Michael Berry of Tadworth, whose death in 1944, while serving in Italy with the R.A.F., has deprived archaeology of one of its keenest workers and of one who, had he been spared, was likely to have done much for the archaeology of Surrey.

*Description of the Site.*

The site lies to the north of Walton and close to Tadworth and is on the extreme northern edge of a plateau, or level summit, of the North Downs, at a height of 550 ft. o.d., with Banstead Heath to the south-west and Walton Heath to the south. The subsoil consists of five to six feet of gravel and sand resting on chalk. From the northern end of the villa the ground drops

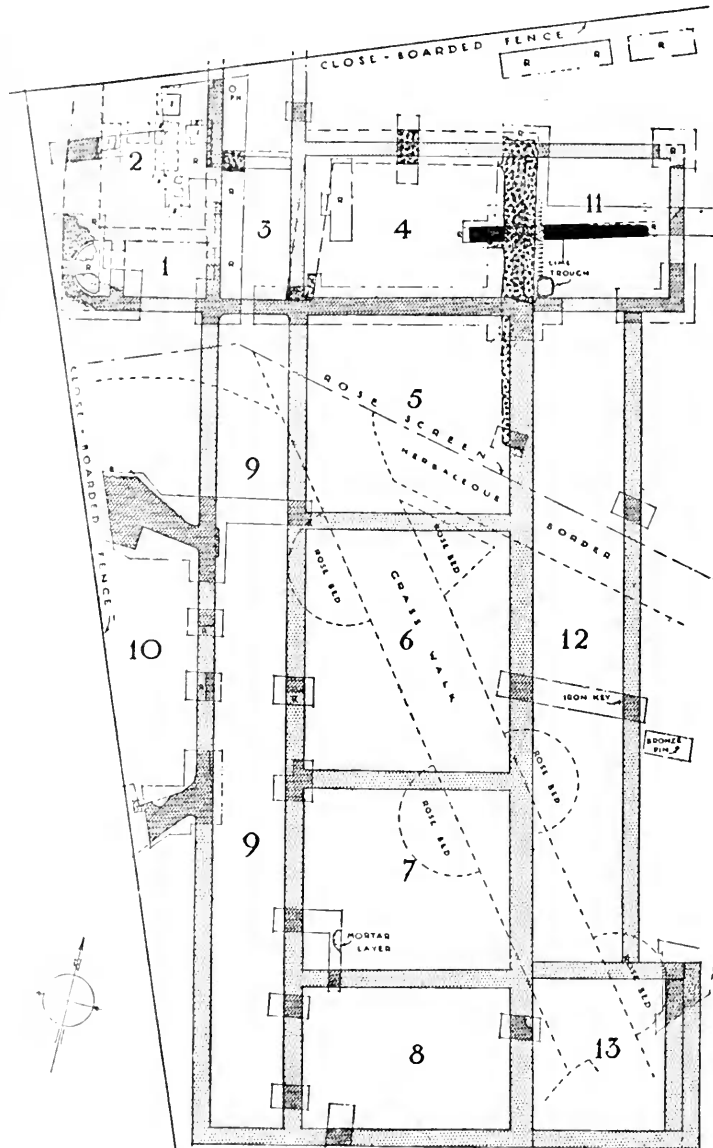

FIG. 1.—PLAN OF SITE.  
 (Block kindly lent by Society for Promotion of Roman studies.)

ROMAN VILLA  
 AT  
 "WINDMILL BANK"  
 WALTON ON THE HILL  
 EXCAVATIONS 1939-40



INDICATIONS

- PERIOD I C.100 A.D.
- PERIOD II C.180 A.D.
- PERIOD III C.300 A.D.

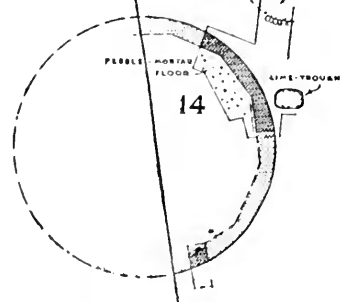

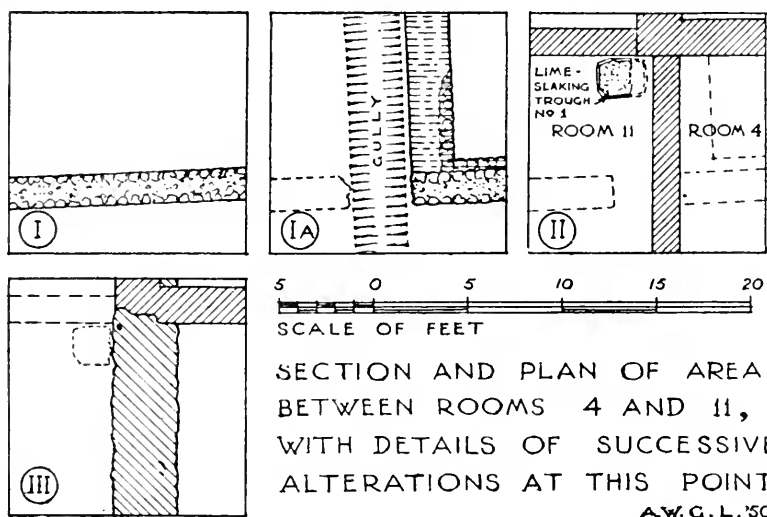
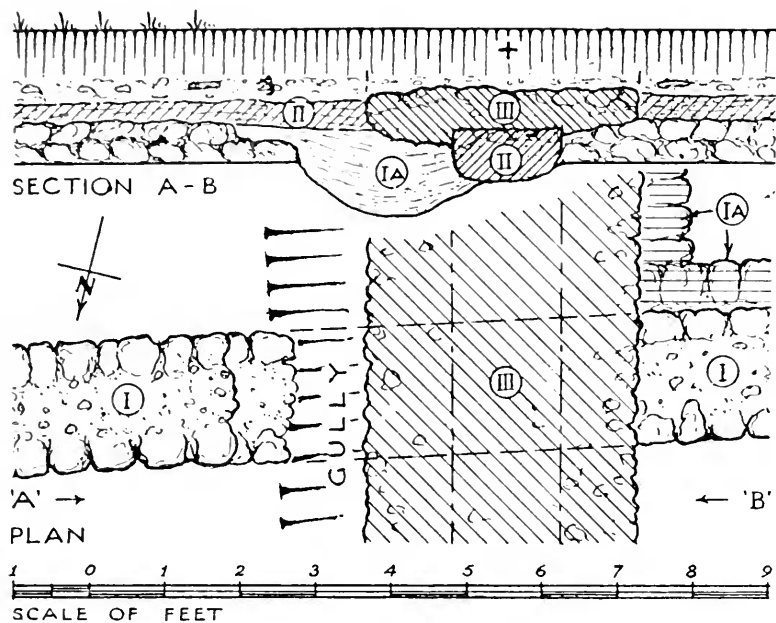

FIG. 2.—PLAN AND SECTION DETAIL.

away fairly steeply to the north and there is an uninterrupted view of many miles in this direction, over the Epsom race-course and beyond to the hills of Kingston and Wimbledon. (The site is recorded on the 6-inch and 25-inch o.s. maps, and the grid reference to the site on the one-inch New Popular Edition map, London, S.W., sheet 170, is 223557). It is  $1\frac{1}{2}$  miles from the Roman villa on Walton Heath; the latter, lying in an east-of-south direction, is the subject of a separate report in this volume (p. 57).

The initial work of 1948 exposed once again the apsidal plunge-bath, and a long trial trench dug to the east of it disclosed a complex junction of walls, of three separate periods, (between rooms 4 and 11 on plan) and proved to be the most important find as regards the elucidation of the history of the successive buildings and so is described in some detail later on (p. 72 and Fig. 2).

### *Summary of Results.*

The site proved to have been occupied in pre-Roman times, during the latter part of the Iron Age, and a certain quantity of pottery dating *circa* A.D. 10-43 was found, mostly in an occupation layer (level 3) about two to three inches thick (with charcoal, calcined flints and some roughly worked flints) resting immediately above the gravel subsoil. This pottery includes pieces of a vessel of south-eastern "B" type (Fig. 5, No. 1) with traces of painted ornamentation on the shoulder; a piece of an (imported) "terra rubra" dish (No. 6), found with the latter, and pieces of several vessels of Patch Grove ware types; all typical of pottery in use during the decade or two prior to the Claudian invasion of A.D. 43.

It appears that there may then have been a gap in the occupation of this site, until the latter part of the 1st century A.D., though this is not certain as some few of the pieces of pottery found (including one or two of the Samian ware fragments) are of the Claudian-Flavian period. Anyhow, a solitary piece of wall, about 25 feet in length as now surviving, and completely robbed of its material at either end (crossing rooms 11 and 4 on plan) was the only remaining portion of a structure dated (from associated pottery) to *circa* A.D. 100. This wall, which is likely to have been part of a small single room, barn-like structure, was not retained when the subsequent villa was erected (*circa* A.D. 180),<sup>1</sup> and the wall separating rooms 4 and 11 had its foundations trench dug through the remaining lower part of this earlier wall.

There was clearly an interval of some years between the destruction of the period I building and the erection of the villa in period II, as a small ditch or gully (containing a certain amount of Hadrianic pottery, had been cut through the early

<sup>1</sup> It was, however, subjected to certain alterations (1a on plan) and this alteration appears to have been of the same date as that of the gully.

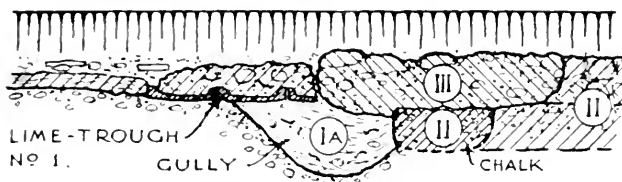

a. E-W SECTION THROUGH LIME -  
SLAKING TROUGH No 1.

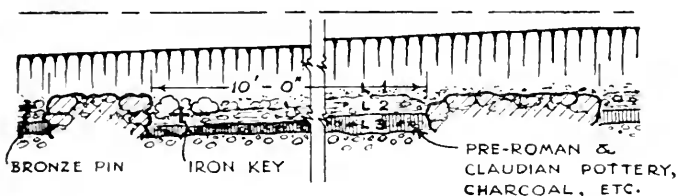

b. E-W SECTION ACROSS CENTRE  
OF CORRIDOR 12.

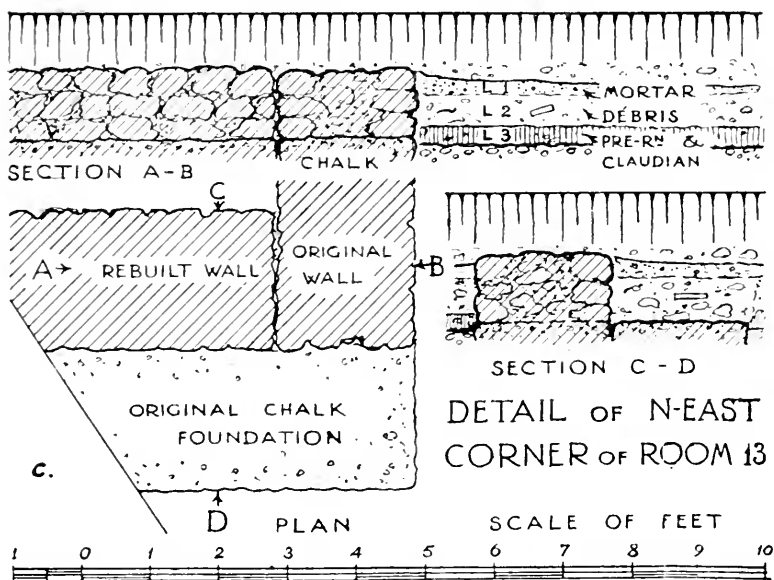

FIG. 3.—DETAILS OF SECTIONS.

wall and then filled with soil and debris before the construction of the period II villa took place, since the foundation of the wall between 4 and 11 (made of chalk, like the other wall foundations of this period) rested on the material filling the lower part of the gully. Hence a period of some fifty years, or more, may have elapsed between the destruction of the early building (*circa* A.D. 200) and the date of the erection of the period II villa (*circa* A.D. 250, or later).

The villa (which was entirely of one period, discounting subsequent repairs or the partial rebuilding in period III) had consisted of a single range of rooms running in a north-south direction, with a corridor, or verandah, at the back and another at the front (see plan). The entrance, on the axis of the largest room (6) of the range, was on the eastern side. Two splayed foundations on the west side (extending into the adjoining garden, where it was not possible to excavate) are likely to have formed part of an octagonal room similar to that at the villa at Great Witcombe, Glos. (*Arch.*, XIX, 1821), and at several other Roman villas. If so, it was probably the main room of the villa, and probably had an elaborate mosaic pavement, but (as was the case with much of the villa) only a few inches of the lowermost part of the foundations had survived, and that at a depth much below that of the original floor.

At the north-eastern corner of the villa were the bath quarters, of which only the plunge-bath and the room off which it opened (1) and the hypocaust of the *tepidarium* (2) could be excavated.

The *caldarium*, *sudatorium* and furnace room, with its stoke-hole, which extended (in this order) to the north of room 2, had been outside the present site, and have clearly all been destroyed both by the present footpath and garden beyond, as well as by reason of the slope of the ground which now drops away fairly sharply to the north from the northern limits of our site.

Room 2, the *tepidarium*, consisted of a hypocaust, of which all the overlying floor had been destroyed, but of which the floor supports (*pilæ*) were for the part excavated, still *in situ*. These consisted of two different types and clearly of different date, so that the bath, if not most of the villa, had become ruinous and had been reconstructed at a later date, but before the date of the final partial rebuilding described later on. A coin of Tetricus II (270-274) found in the débris filling the ruined hypocaust (a coin which was in a very good state of preservation) suggests that the baths were finally destroyed about this date so the reconstruction referred to may have taken place about A.D. 280 or 300.

The purpose of the isolated circular structure (14) with a polygonal-sided internal room, and with some of its *opus signinum* floor and quarter-round angle moulding still in position, is not certain. (More than half of it extended beyond the limits of the site.) It has a fairly close parallel in the polygonal detached room found at the villa at Stroud, near Petersfield, Hants (*Arch.*

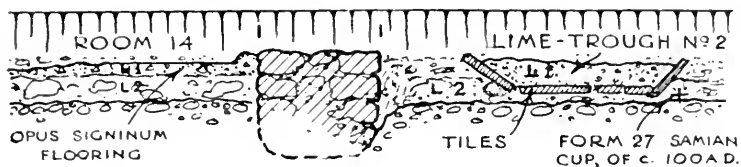

a. W-E SECTION THROUGH CIRCULAR BUILDING (RM 14) AND LIME-TROUGH 2

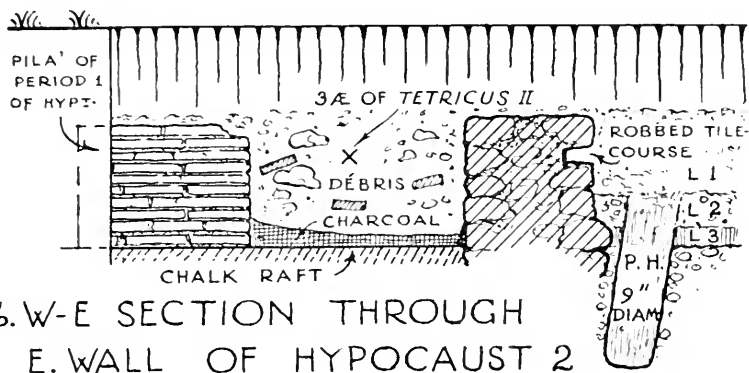

b. W-E SECTION THROUGH E. WALL OF HYPOCAUST 2

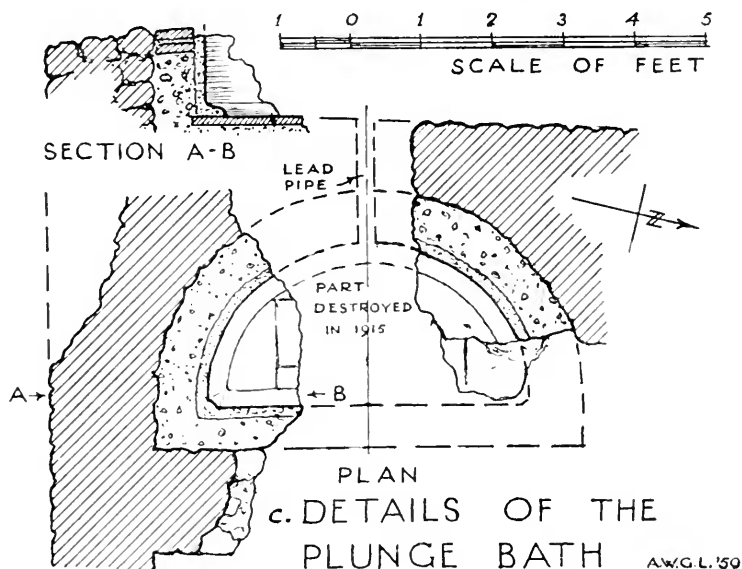

c. DETAILS OF THE PLUNGE BATH

FIG. 4.—HYPOCAUST AND PLUNGE BATH DETAILS.

*Journ.*, LXVI, 38, 1909).<sup>1</sup> It seems probable, from the care taken to shape the inner wall-surface, that it was intended for some domestic, rather than utilitarian, purpose.

The east wall of the small square room (13) at the south end of the east corridor possessed a feature of particular interest (Fig. 3c). It had been built (perhaps only partially) two feet farther to the east than was evidently intended, or than the amount of the projection of the corresponding wall at the north end of the villa (that to room 11). To correct this, a fresh chalk foundation was formed inside this wall, and the flint walling pulled down and rebuilt on the new foundation. Such a correction, and of an error which would not have been very apparent if it had been allowed to remain, implies that the building work was carried out under the supervision of someone who was the equivalent of a present-day architect, or of a clerk of the works.

Evidence of the latest work—a rebuilding apparently of only a part of the villa, and at some time late in the 4th Century A.D.—was found only at the northern end of the site. It consisted of the lowest part of some very broad foundations, executed in very poor materials (flints set in yellow, sandy mortar, with much chalk and semi-slaked lime), and its nearness to the present surface of the ground probably accounts for there being no trace of this rebuilding for the southern half of the villa, where the fall in the ground level would account for its disappearance. Three *minimissimæ*—minute coins of Lydney type and dating *circa* A.D. 400—were found in contact with these latest foundations and immediately above them.

Some of the earlier walls were completely rebuilt in this late period, and are covered by the broad foundations (*e.g.*, the north and west walls of 4). Others were thickened (*e.g.*, the east wall of 5), while the west wall of 4 was rebuilt, overriding the earlier foundation and on a different alignment. Some of the earlier walls must, however, have still been standing, at least as regards their lowest part (*e.g.*, the south wall of 3 and 4) as the later work is carried up to and against them. It is likely that this latest rebuilding should be dated to the extreme end of the 4th Century A.D., rather than *circa* A.D. 300 as has been suggested on the plan (Fig. 1). In short, the site was occupied from about A.D. 10 to about A.D. 400.

#### *Details of the Excavations.*

As regards the recovery of the history of the various buildings, or rebuilt structures, the most important evidence was obtained from the part, already mentioned, between rooms 4 and 11. Here (Fig. 2) walls of three periods,<sup>2</sup> and a ditch or gully of a

<sup>1</sup> Or to the octagonal room at the villa at Loose Road, Maidstone, Kent, published in *Arch. Cant.* X; 1876.

<sup>2</sup> Also the alterations, previously noted, to the period I wall.



PLATE III



*Photos by S. S. Frere, F.S.A*

1. GENERAL VIEW OF NORTH END OF SITE, LOOKING EAST, DURING PROGRESS OF EXCAVATIONS.
2. WALL BETWEEN ROOMS 4 AND 11 : VIEW LOOKING SOUTH-EAST.
3. INTERSECTION OF WALLS OF PERIODS I-III : VIEW LOOKING EAST.

PLATE IV



*Photos by S. S. Freere, F.S.A.*

1. PART OF LIME SLAKING TROUGH, NO. 1.
2. NORTH-EAST CORNER OF ROOM 13. (See Fig. 3c.)
3. OUTER WALL AND FLOOR OF CIRCULAR BUILDING (14), LOOKING NORTH-WEST.

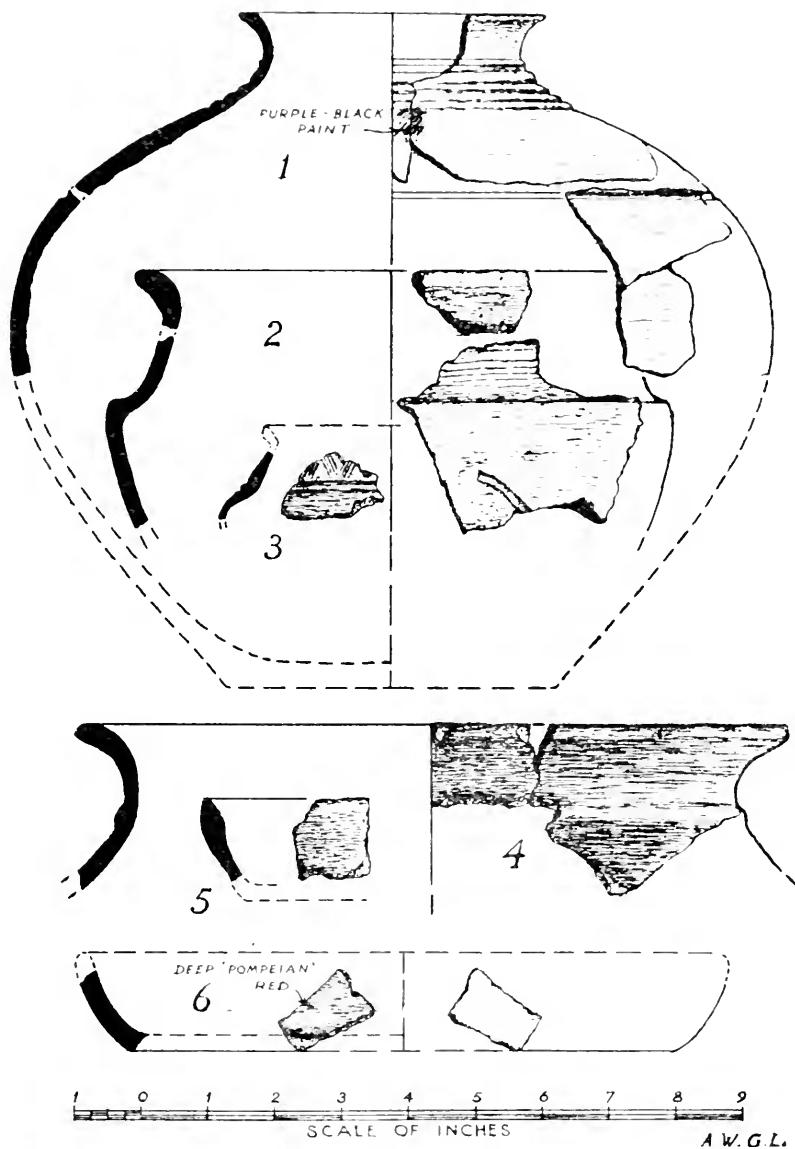

FIG. 5.—NATIVE, AND IMPORTED, PRE-CLAUDIANT POTTERY FROM THE EARLIEST OCCUPATION LEVEL.

period (Ia) between that of the two first periods, all either intersect or lie one upon the other. In addition, in the south-west corner of 11 was found the lime-trough (formed of roof-tiles) in which lime used for the plastering of the period II walls was slaked (Fig. 3a). In the lime still remaining in this trough were found the pieces of a cooking pot (Fig. 8, No. 29) which are of late 3rd-century, or early 4th-century, date. Also, about half of this trough was cut away when the late broad-wall foundation, between rooms 4 and 11, was constructed.

The pottery from the gully which cuts across the period I wall and underlies, in part, both the period II foundation and the lime-trough, includes some pieces (Fig. 7) which are of Antonine date, but most of it is Hadrianic, while some of it is of still earlier date. From the fact that it consists of stray pieces from a number of vessels, and includes no complete, or even nearly complete, pots, it is likely that this pottery was lying on the surface when the gully was filled in and that it represents pottery used when the period Ia structure was in use. Also the gully, from an absence of silt, appeared not to have been open for any great length of time and to have been filled deliberately. The fact that it nearly coincides with the wall between rooms 4 and 11, and does not extend beyond the north and south walls of these rooms, implies that it was dug as an external drain for the shortened building of period Ia.

Some further evidence for dating period II was obtained, in the form of pottery including the Samian ware cup-base (form 33) with the stamp of the Antonine potter Genialis, in corridor 9, and beneath a thin spread of mortar. Another lime-trough and some more stratified pottery was found just outside the isolated, circular room, No. 14, as well as from beneath the remains of *opus signinum* flooring inside this building. As well as some pottery of Hadrianic-Antonine date, it included some earlier pieces, amongst which was the upper part of the native-ware pot, Fig. 6, No. 7.

The small apsidal plunge-bath, originally uncovered in 1915, was located and re-excavated, and calls for no special comment. It had been very well constructed of tiles covered with *opus signinum*, of good hard quality and with a very smooth surface, and with quarter-round angle-mouldings. The narrow trench cut through it in 1915 (when the lead outlet-pipe was discovered) was apparent, and can be seen on the photographs taken at that date by Mr. E. Yates, F.S.A., to whom I am indebted for the copies here reproduced. (Plate V).

Room 2, the *tepidarium* (Fig. 4b), originally had square (18 inch by 18 inch, approx.) tile built floor supports. When, as mentioned above, this hypocaust was reconstructed, some additional smaller supports were inserted, and some of these were built against the earlier supports, or *pilæ*. (For the earlier *pilæ*, in addition to tiles of normal dimensions, some of those employed measure 3 inches

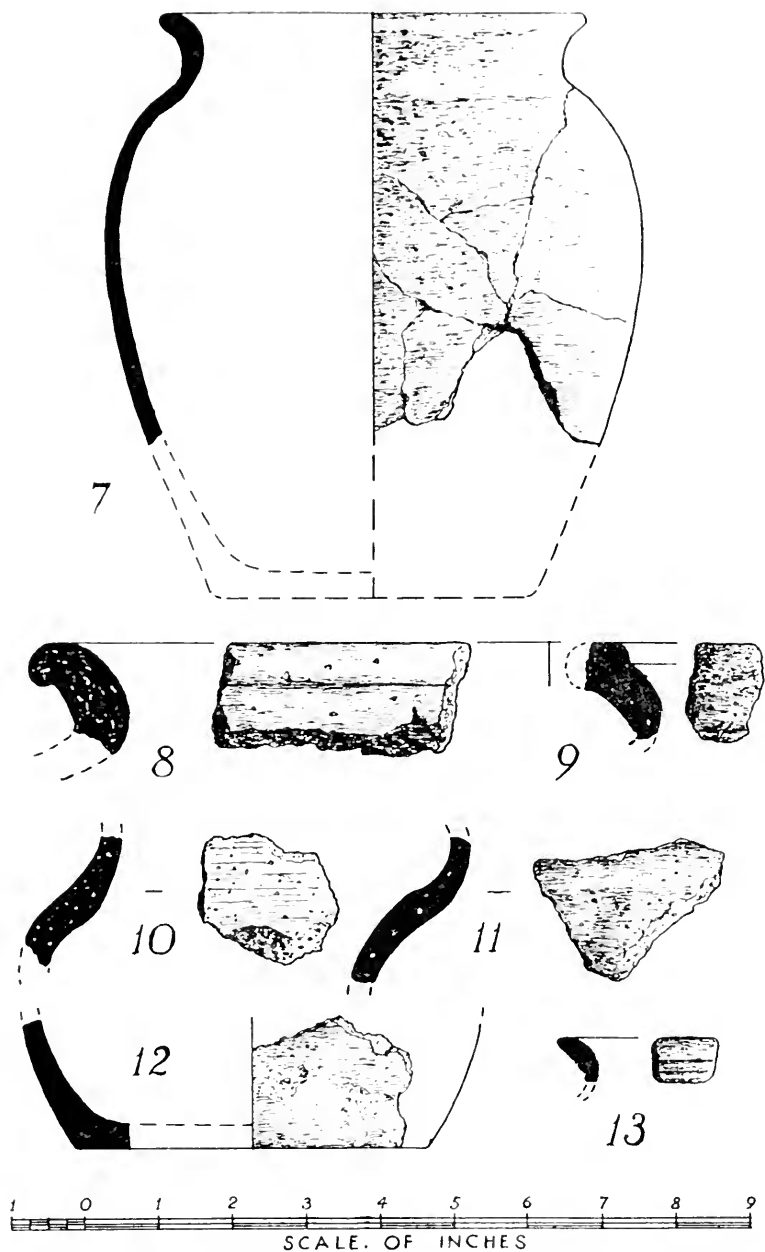

FIG. 6.—NATIVE WARE OF THE EARLIEST OCCUPATION PERIOD.

by 6 inches by  $15\frac{1}{2}$  inches. It is a point worth noting that bricks of such unusual size and shape were sometimes employed in the Roman period, since, if found apart from a Roman building, it might be difficult to decide as to their actual date).

The post-hole found immediately outside the east wall of 2, in the northward extension of corridor 9, was probably formed by part of the scaffolding used when the period II building was erected. It had been filled in with soil and debris and had contained a circular post, or pole, of 9-inch diameter, extending to a depth of 2 feet 6 inches below the top of the adjacent wall-foundation (Fig. 4b).

The remains of the buildings were extensively robbed during mediæval times and, at the same period, there was some digging of the site for gravel, extending to a depth of three or four feet, in the area north of rooms 4 and 11, as well as inside room 4. Refuse, including much pottery dating from *circa* 1250-1400, had been deposited in the pits so formed, and it seems likely that this removal of gravel, tiles, etc., took place in connection with building work at Walton Manor, which is at no great distance to the south and which, in addition to the 14th-century work still to be seen there, has a Norman *motte* close to it and on which the foundations of some structures were found (but not properly recorded) during the last century.

Some of the robbing had, however, clearly taken place in Roman times and prior to the erection of the final building. Evidence of this was found in the hypocaust of room 2 of the baths, and in connection with the east wall of this room. The robbing of tiles from the *pilæ* of the reconstructed hypocaust, and from the bonding-course of the east wall (where the removal of tiles had left a slot in the outer face of the wall), had taken place in late Roman times, as shown by the stratification. Hence, as at many other sites, it is clear that the bath annexe was not included in the latest and final reconstruction of the villa.

### *Building Materials.*

In addition to the use of flints for the rubble masonry of the walls, some few pieces of greensand stone were employed, but as roughly broken pieces of stone and not as squared or dressed masonry. One or two large pieces of gravel-iron conglomerate, the so-called pudding stone, were also found built into the walls.

A number of loose, brick *tesserae* were found, and a few mosaic *tesserae* (of hard chalk, etc.), but probably as the result of subsequent ploughing and the slope of the site already mentioned, no paving was found *in situ*, apart from the small patch of *opus signinum* in the isolated circular building (14).

The fact that, save for a very few small pieces, no flue-tile fragments were found in the debris filling the ruined hypocaust (2) suggests that these flue-tiles had been carefully removed when the bath annexe was dispensed with, either for re-use at another

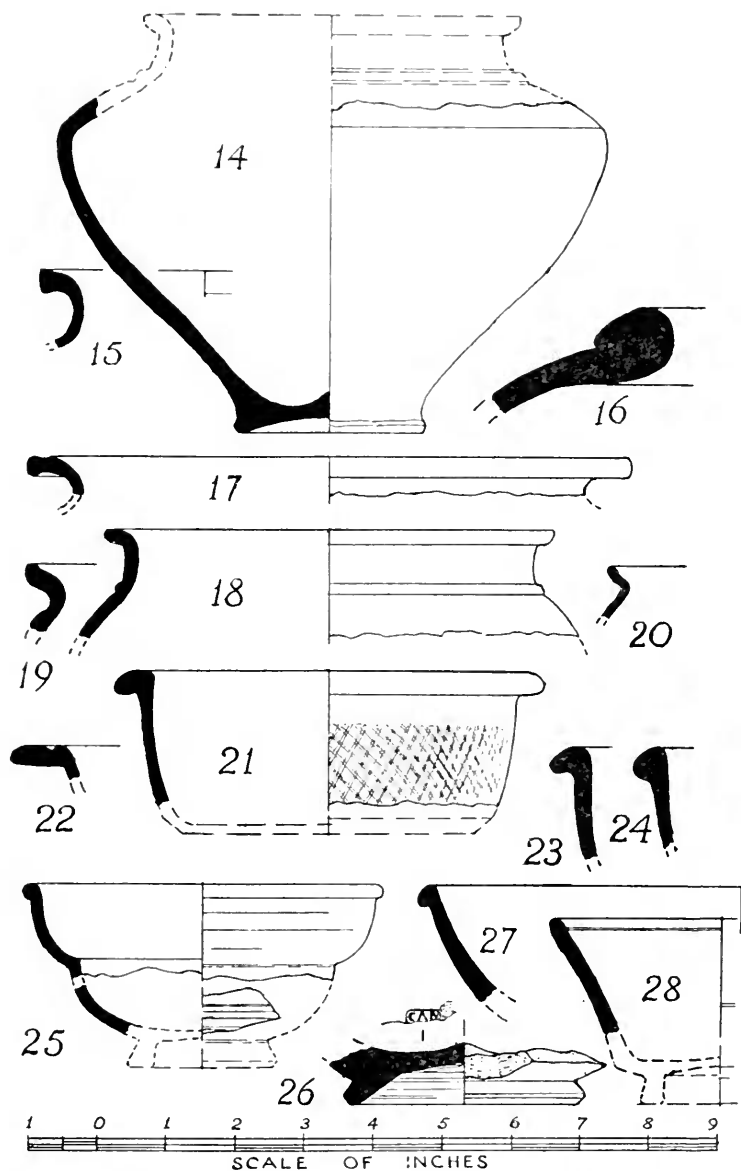

POTTERY FROM THE GULLY OF  
PERIOD I A. A.W.G.L.'50.

FIG. 7.—PERIOD IA POTTERY.

site or (as was sometimes the case, e.g., at the Ashted Common site) for use as drain pipes.

*Finds (not including the pottery).*

(a) *Stone.*

Piece of a quern, of a hard grit-stone, 2 inches thick and of 18 inches diameter, with a central hole, originally about  $1\frac{1}{2}$  inches in diameter. (Not figured).

(b) *Iron.*

Key (Fig. 9a). Probably a door-key; of a common Roman type, it was found in level 2, close to the front wall of the east corridor.

Tanged knife-blade (Fig. 9b). Found with 4th-century pottery (level 1) beside south wall of room 3.

Two styli (not figured). Both from level 1.

(c) *Bronze.*

Pin,  $4\frac{1}{4}$  inches long, with conical head. From level 2, outside wall of east corridor.

(d) *Coins.*

The four coins found during the excavations (a 3 Æ of Tetricus II, and three 4th- and 5th-century minimissimæ, of Lydney type) together with three or four coins found (during gardening operations) in the adjoining garden, were, unfortunately, lost in the post when (October, 1940) being sent to an expert for his opinion on them. They were not, however, of much consequence for dating the various periods of the structures, and this can only be arrived at, somewhat approximately, from the pottery from the various stratified levels.

*The Pottery.*

(a) *From the earliest occupation level (level 3) on the natural subsoil. (Figs. 5 and 6).*

1. Upper part of a large pot, of orange-brown soapy-surfaced ware. Horizontal ribbing at the neck, and with remaining traces of painted ornamentation, in a purple-black paint. This vessel, of "eastern-B" type, has parallels from sites in Sussex. No. 13 may be from a similar vessel.

2, 4, 7, 11 and 12. Pieces of pots of Patch Grove ware, similar to some found at Purberry Shot, Ewell (S.A.C., L.)

3. Shoulder fragment of a small pot of a black, burnished ware and with a band of ornament consisting of alternate sloping lines. Hand-made, Belgian ware.

5. Piece of rim of a dish of brown, soapy, hand-made ware.

6. Dish, of imported *terra rubra* ware. Buff, micaceous paste, coated internally with a thick coating of deep pompeian red colour.

8, 9 and 10. Pieces of large store-pots of hand-made gritted ware. (Many pieces from the walls of vessels of this type were found in level 3 and later levels).

(b) *Arretine ware from level 3 (Fig. 9).*

41. A single small piece from rim and side of an Arretine platter, apparently of the type S4B as found at Colchester (*Camulodunum*, Hawkes and Hull, pl. XXXIX, and p. 182) was obtained from level 3, outside the east wall of room 2 (Section, Fig. 4b). Date:—pre-Claudian, or Claudian.

(c) *From the gully of Period 1a (Figs. 2 and 7). Samian and coarse ware of typical Hadrianic and Hadrian-Antonine forms, including some pieces (e.g., the store-jar bead-rim, no 16) of earlier ware.*

*Bowls as 21, 23, and 24, were present in some quantity.*

26. Base of Samian bowl, form 18/31, of thick poor quality, Antonine ware. Part of the stamp with letters CAN. . . (Candidus?).

25 and 28. Samian cups, of forms 27 and 33, of Hadrian-Antonine ware.



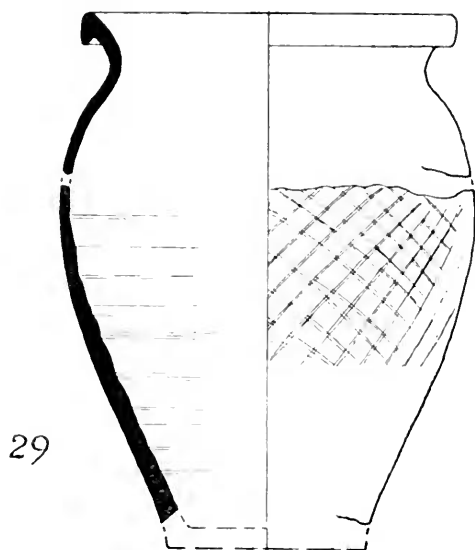

COOKING - POT FROM LIME IN  
SLAKING - TROUGH No. I.

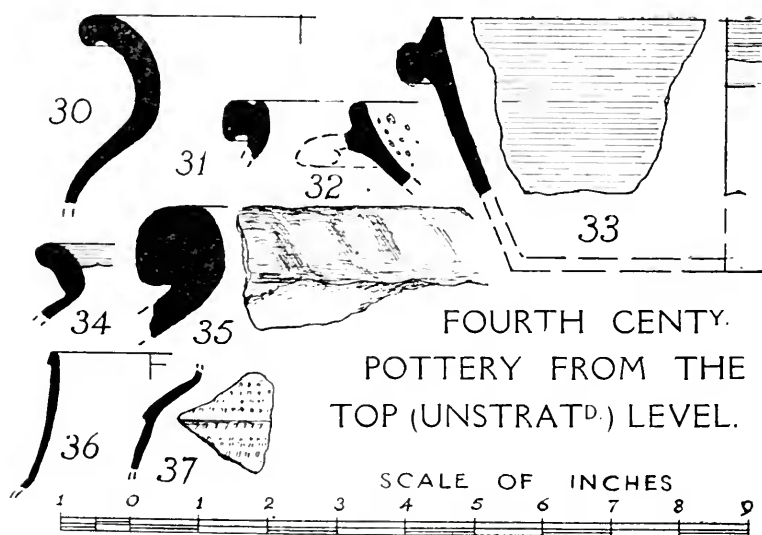

FOURTH CENTY.  
POTTERY FROM THE  
TOP (UNSTRAT<sup>D</sup>.) LEVEL.

SCALE OF INCHES

FIG. 8.—POTTERY.

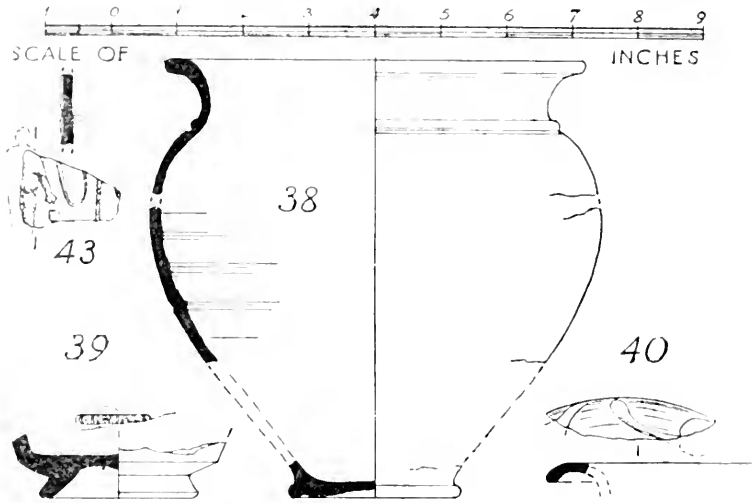

POTTERY PRE-DATING PERIOD II VILLA. (L.2, BELOW E. CORRIDOR)

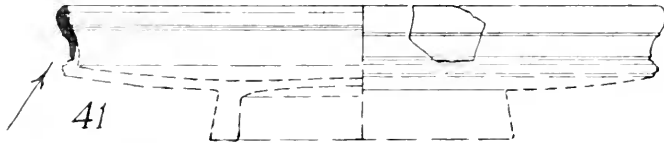

PIECE OF 'ARRETINE' PLATTER (L.3, AD NAT.)

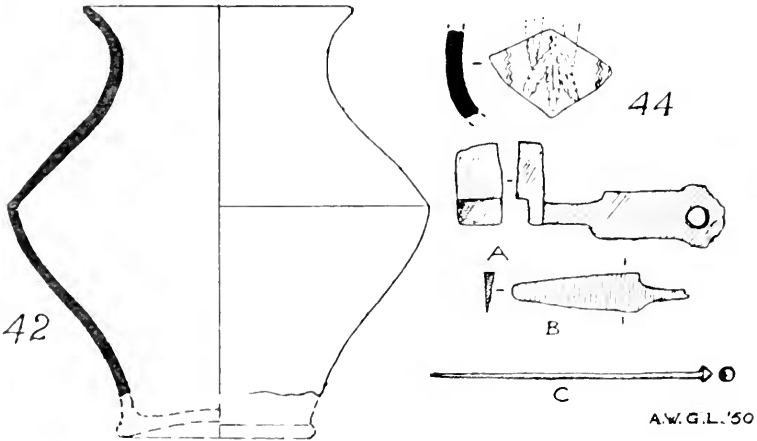

FIG. 9.—POTTERY AND SMALL FINDS (A—C).  
 A, Iron key ; B, Iron knife-blade ; C, Bronze pin.



*Photos by E. Yates, I. S. A.*

THE APSIDAL PLUNGE BATH ROOM I AS EXPOSED IN 1915 AFTER  
PARTIAL DESTRUCTION BY ARMY TRENCHING.



1 AND 2. VIEWS OF HYPOCAUST (ROOM 2).

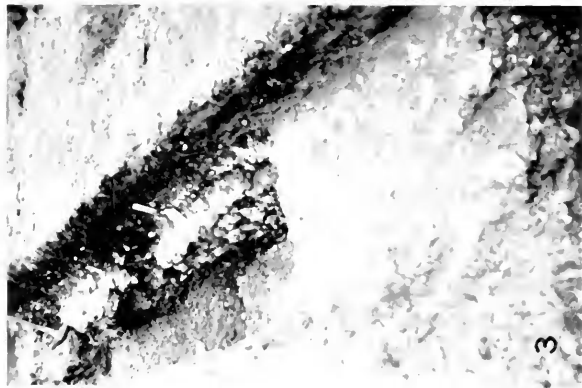

*Photos by S. S. Freyre, F.S.A.*

3. VIEW, LOOKING EAST, OF BROAD  
(PERIOD III) FOUNDATION BE-  
TWEEN ROOMS 4 AND II; PERIOD  
I WALL IN BACKGROUND.

27. Rim, of form 18/31, of good ware. Early 2nd-century.
- (d) *From the lime in the lime-slaking trough No. 1. (Figs. 3a, and 8).*
29. Pieces, forming about half, but without the base, of a cooking pot of hard, dark blue-grey ware, with band of roughly executed lattice ornament. Probably of early 4th-century date. This pot must have been thrown into the lime in this trough while the lime was still soft, since the pieces were all embedded in it. The trough belongs to the Period II building, but may have been formed to slake lime for re-decorating (replastering) the walls, and need not have been used for the original period II building work. Part of it was destroyed by the broad-wall foundation of period III, the final period.
- (e) *Late Roman (4th-5th-century) pottery from the uppermost level (level 1) and from the top-soil. (Fig. 8, Nos. 30-37).*
30. Rim of pot, of hard buff ware containing coarse grit particles. 4th-century. Unstratified.
31. Rim of a narrow-necked large jar (probably of globular shape and with band of combed ornament) identical to those made at the Snailslynch kiln site at Farnham. This much worn fragment has lost all traces of the white slip surfacing which is usual with these vessels. Late 3rd, or early 4th-century.
32. Piece of a mortarium of hard, white ware, with pinkish quartz gritting to inner surface. 3rd-century.
33. Flanged bowl, of grey ware with white slip coating to inside and top of rim. Typical of vessels made at the 4th-century kiln sites at Farnham and in Hants. (Alice Holt, and at the New Forest sites). For similar vessels from the bath-house at Cobham *v. S.A.C., L., p. 86, Fig. 6.*
34. Rim of grey ware with white slip coating. Typical of vessels produced at the Farnham kiln sites. Late 3rd-century.
35. Cable-patterned rim of a large store-jar of New Forest and Alice Holt type and probably made at the 4th-century potteries in the Farnham district.
- 36 and 37. Pieces of colour-coated beakers, the latter of a common shouldered and rouletted type. *Circa A.D. 300.*
- (f) *Pottery (from level 2) found beneath the east and west corridors, and pre-dating the period II villa. (Figs. 3b and 9).*
38. Wide mouthed jar of dark grey ware, flecked with small white and black particles. Antonine—of about A.D. 200.
39. Samian cup base, form 33, with stamp of the Antonine potter Genialis, who worked at the Reinzabern pottery works. West corridor, level 2.
40. Samian bowl rim, with barbotine ornament, form 35. 2nd-century.
43. Piece of a decorated Samian ware bowl, form 30. Draped figure, with extended left arm. *Circa A.D. 90-100.* East corridor, level 2.
- (g) *From beneath lime-slaking trough No. 2, (Section Fig. 4a, level 2).*
42. Carinated pot of dark brown-grey ware. Date—*circa A.D. 100*, this type (of which examples were found at the Purberry Shot, Ewell, and Ashted Common sites) is a late form of the sharply carinated pots of Claudian and Flavian date.
44. (Unstratified).
- Piece of a decorated Samian bowl (form 37) with part of a panel of leaf and tendrill ornament, between vertical zig-zag lines. Date—*circa A.D. 90-100.*