

HIGH FELLSIDE, MIDDLETON, CUMBRIA

Archaeological Building Recording



Client: Mike Smith

NGR: 363598 488903

Planning Application Ref.:
SL/2009/0903

© Greenlane Archaeology Ltd

August 2012



Greenlane Archaeology Ltd,
2 Albrights Yard, Theatre Street,
Ulverston, Cumbria, LA12 7AQ

Tel: 01229 588 500
Email: info@greenlancearchaeology.co.uk
Web: www.greenlancearchaeology.co.uk

Contents

Non-Technical Summary	3
Acknowledgements.....	3
1. Introduction	4
2. Methodology	6
3. Desk-Based Assessment.....	7
4. Building Recording.....	11
5. Discussion.....	30
6. Bibliography	32
Appendix 1: Details from the Census Returns, 1841-1901	34

Illustrations

List of Figures

Figure 1: Site location	5
Figure 2: North and east external elevations and plan of the lower level features.....	17
Figure 3: South and west external elevations and plan of the upper level features.....	18
Figure 4: Cross-section A-A1.....	19

List of Plates

Plate 1: General view of the site from the west, with the barn to the left and rebuilt house to the right.....	4
Plate 2 (left): Extract from the estate plan of 1801 (CAC(K) WDB/35 1801).....	7
Plate 3 (right): Extract from the Tithe map of 1843 (CAC(K) WDRC/8/292 1843)	7
Plate 4 (left): Extract from the Ordnance Survey map of 1862.....	8
Plate 5 (right): Extract from the Ordnance Survey map of 1898	8
Plate 6: Extract from the Ordnance Survey map of 1914.....	8
Plate 7 (left): East end of the south external elevation.....	12
Plate 8 (right): Central part of the south external elevation	12
Plate 9 (left): Graffiti in the jamb of the wagon doorway.....	12
Plate 10 (right): The wagon doorway and adjacent window in the centre of the south external elevation.....	12
Plate 11 (left): West end of the south external elevation.....	13
Plate 12 (right): General view of west external elevation	13
Plate 13 (left): Return in the centre of the west external elevation.....	14
Plate 14 (right): West end of the north external elevation	14
Plate 15 (left): Wagon doorway in the centre of the north external elevation.....	15
Plate 16 (right): Centre and east end of the north external elevation.....	15
Plate 17 (left): General east end of the east external elevation	16
Plate 18 (right): Southern section of the east external elevation.....	16
Plate 19 (left): South-west corner of the Ground Floor Room 1	20
Plate 20 (right): Stall partitions in Ground Floor Room 1	20

Plate 21: Alcove in the west elevation of Ground Floor Room 1	20
Plate 22 (left): Stall partitions in the Ground Floor Room 3.....	21
Plate 23 (right): Detail of the stall partitions in Ground Floor Room 3.....	21
Plate 24 (left): North elevation of Ground Floor Room 3	22
Plate 25 (right): East elevation of Ground Floor Room 3	22
Plate 26 (left): South elevation of Ground Floor Room 3	22
Plate 27 (right): Partially blocked doorway at the east end of the south elevation of Ground Floor Room 3.....	22
Plate 28 (left): West elevation of Ground Floor Room 4.....	23
Plate 29 (right): Detail of the stone partition on the ground floor with graffitied rail above.....	23
Plate 30 (left): Wagon door in the north elevation of Ground Floor Room 4	23
Plate 31 (right): Vent slots in the north elevation of Ground Floor Room 4.....	23
Plate 32 (left): The east elevation of Ground Floor Room 4.....	24
Plate 33 (right): Blocked doorway in the south elevation of Ground Floor Room 4	24
Plate 34: Doorway in the south elevation of Ground Floor Room 4	24
Plate 35 (left): North elevation of Ground Floor Room 5	25
Plate 36 (right): West elevation of Ground Floor Room 5	25
Plate 37 (left): North elevation of Ground Floor Room 6	25
Plate 38 (right): Doorway on the east elevation of Ground Floor Room 6	25
Plate 39: Doorway in the south elevation of Ground Floor Room 6	26
Plate 40 (left): North elevation of Ground Floor Room 7	26
Plate 41 (right): West end of the south elevation of Ground Floor Room 7	26
Plate 42 (left): West elevation of Ground Floor Room 7.....	27
Plate 43 (right): South end of First Floor Room 1.....	27
Plate 44 (left): South-west corner of First Floor Room 2	28
Plate 45 (right): Truss above the west end of First Floor Room 2.....	28
Plate 46 (left): General view of the trusses in First Floor Room 2, looking west.....	28
Plate 47 (right): Detail of the easternmost truss in First Floor Room 2	28
Plate 48: '1711' chiselled into the truss	28

Non-Technical Summary

Following the submission of a planning application for the conversion of a disused barn at High Fellside, Middleton, Cumbria, a condition was placed on the application that an English Heritage Level 2 archaeological building recording be carried out. Although not listed the farm is shown on Jefferys' map of Westmorland, dated 1770, and so the building is considered to be of some historic interest and therefore worth recording so that a permanent record of it is made prior to conversion. Greenlane Archaeology was commissioned to carry out the building recording, which was undertaken in August 2012.

Little is known about the early history of the building, and there is some confusion in the documentary sources as there were originally two farms known simply as Fellside, now High and Low Fellside. The farm now known as High Fellside is shown on Jefferys' plan of 1770 and on a detailed estate plan of 1801, by which time it had clearly taken much of its present form. Later maps show that some additional extensions were made during the 19th and 20th century and a detailed description of the building contained in sales particulars of 1919 shows that it comprised a number of elements.

The building recording revealed that the earliest phase of the building comprises a large threshing barn, comprising a variant form of bank barn and Lancashire barn that, on comparison with other known sites in the local area, seems to be a type found specifically in the upper Lune Valley. A date of 1711 chiselled into one of the trusses is likely to be the date of construction, and it is clear from the plan of 1801 that the original building had been enlarged with the addition of two extensions by this time. It was clearly further enlarged again during the 19th and 20th century, probably to provide additional accommodation for cattle. During the latter part of the 20th century and into the 21st the most significant alterations have been the need for repair and stabilisation of several parts of the walls.

The building represents a good example of a variant bank barn and is also similar in style to two other barns recorded in the upper Lune Valley, which appear to represent a local form, apparently a variation on a Lancashire Barn. This, plus the relatively good dating evidence for its initial construction are certainly noteworthy features.

Acknowledgements

Greenlane Archaeology would like to thank Mr Mike Smith for commissioning the project and for his help and assistance on site, and the Wright Design Partnership, in particular Frances Atkinson, for providing the 'as existing' drawings of the building. Additional thanks are due to the staff of the Cumbria Archive Centre in Kendal (CAC(K)) for their help in accessing their records.

The desk-based assessment was carried out by Dan Elsworth and the building recording was carried out by Dan Elsworth and Tom Mace. The report was written by Dan Elsworth and the illustrations produced by Tom Mace. The report was edited by Jo Dawson and Dan Elsworth managed the project.

1. Introduction

1.1 Circumstances of the Project

1.1.1 Following the submission of a planning application (Ref. SL/2009/0903) to convert a disused barn at High Fellside, Middleton, Cumbria (NGR 363598 488903) into a domestic dwelling, a condition was placed by South Lakeland District Council, that an English Heritage Level 2 type recording of the building should be carried out (English Heritage 2006). This is intended to provide a record of the building before conversion. Greenlane Archaeology was commissioned by the Wright Design Partnership on behalf of Mr Mike Smith (hereafter 'the client') to carry out the building recording. A project design was produced in response and following its acceptance by Jeremy Parsons, Historic Environment Officer at Cumbria Country Council, the work was carried out in August 2012.

1.1.2 The building is not listed but the farm is recorded on Jefferys' map of 1770 and so it is considered likely to be at least 18th century in date.

1.2 Location, Geology, and Topography

1.2.1 The site is situated approximately 3.5km north of the nominal centre of Middleton, the nearest towns being Kirkby Lonsdale to the south and Sedbergh to the north, and it is less than 1km east of the former Roman road running north/south up the Lune Valley, now the A683 (Figure 1). It is on the edge of open moorland to the east and at approximately 180m above sea level (Ordnance Survey 2005). The barn is situated on the north side of a track that winds up from the A683 to the west, with the site of the former farmhouse, now rebuilt but on the same footprint and apparently called High Fellside Hall, on the opposite side of the track to the south (Plate 1).



Plate 1: General view of the site from the west, with the barn to the left and rebuilt house to the right

1.2.2 The solid geology of the area is dominated by Bannisdale slates of the Silurian group, although there is a large area of Downtonian Scout Hill Flags immediately to the south, and extensive areas of Carboniferous limestone to the east and west (Moseley 1978, plate 1). The solid geology is overlain by glacial till, which forms thick hummocky deposits in the valley bottoms (Countryside Commission 1998, 66). The landscape is characterised by 'low fells and ridges' dominated by pasture set within dry stone walls with only small areas of woodland (*op cit*, 64). Higher ground is more rugged, comprising 'heathland and rough grassland, interspersed with rocky outcrops, small tarns and becks, and stretches of bracken' (*op cit*, 66).

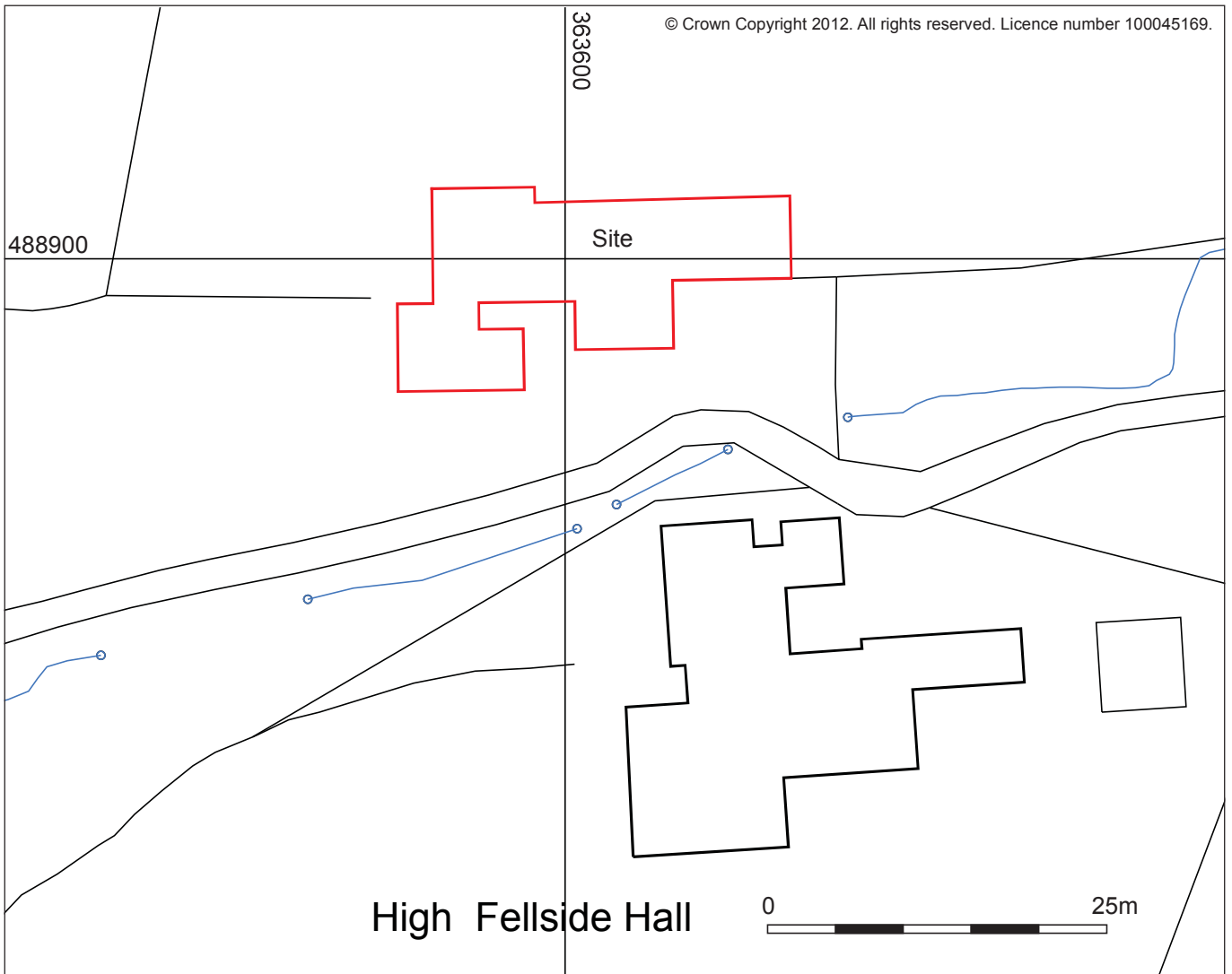
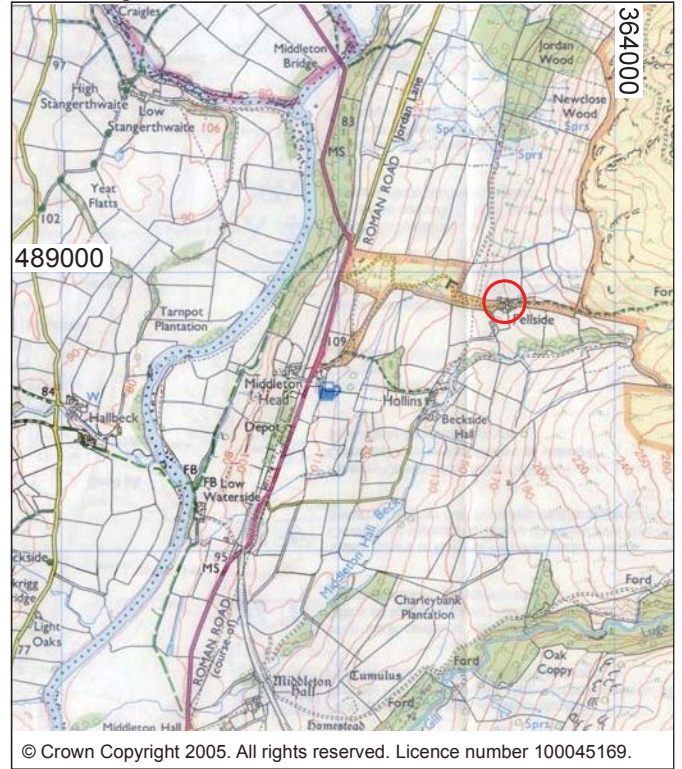
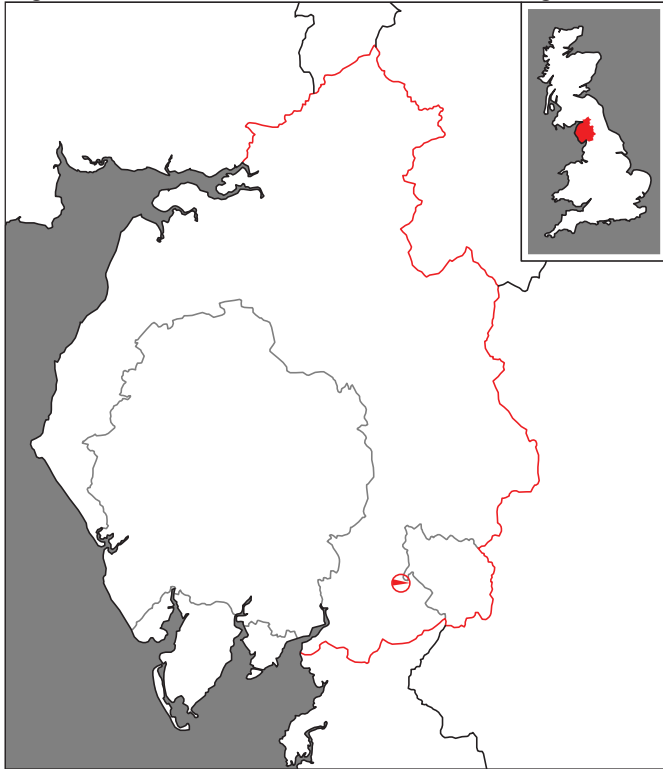

Client: Mike Smith

© Greenlane Archaeology Ltd, August 2012

Figure 1: Site location

2. Methodology

2.1 Introduction

2.1.1 The building investigation comprised three separate elements intended to provide a suitable record of the structure, in line with English Heritage standards (English Heritage 2006) and the guidelines of the Institute for Archaeologists (IfA 2008a). In addition a desk-based assessment was carried out in accordance with the project design and IfA guidelines (IfA 2008b) prior to the building recording, and a suitable archive was compiled to provide a permanent record of the project and its results in accordance with English Heritage and IfA guidelines (English Heritage 1991; Brown 2007).

2.2 Desk-Based Assessment

2.2.1 Information was gathered from the following locations:

- **Cumbria Archive Centre, Kendal (CAC(K))**: this was visited in order to examine early maps of the site and other primary sources as well as secondary sources such as trade directories in order to identify information about the development and use of the building;
- **Greenlane Archaeology library**: additional secondary sources were used to provide information for the site background.

2.3 Building Recording

2.3.1 The building recording was carried out to English Heritage Level-2 type standards (English Heritage 2006), which is a largely descriptive investigation, with the interpretation only making a limited use of the available documentary information. The recording comprised the following elements:

- **Written record**: descriptive records of all parts of the building were made using Greenlane Archaeology *pro forma* record sheets;
- **Photographs**: photographs in both 35mm colour and colour digital format were taken of the main features of the building, its general surroundings, and any features of architectural or archaeological interest. A selection of the colour digital photographs is included in this report, and the remaining photographs are in the project archive;
- **Drawings**: drawings were produced by hand-annotation of printed plots of 'as existing' architect's drawings provided by the client's architect. In addition, a cross-section was produced by hand. The drawings produced ultimately comprised:
 - i. each of the principal elevations at a scale of 1:100;
 - ii. a plan of each of the principal floors at a scale of 1:100;
 - iii. a cross-section at a scale of 1:50.

2.4 Archive

2.4.1 A comprehensive archive of the project has been produced in accordance with the project design and current IfA and English Heritage guidelines (Brown 2007; English Heritage 1991). The paper and digital archive and a copy of this report will be deposited in the Cumbria Archive Centre in Kendal on completion of the project. Three copies of this report will be provided for the client, and one will be retained by Greenlane Archaeology. In addition a digital copy of the report will be provided to client's agent and the Cumbria Historic Environment Record (HER) in Kendal and a digital record of the project will be made on the *Online Access to the Index of Archaeological Investigations* (OASIS) scheme.

3. Desk-Based Assessment

3.1 Map Regression

3.1.1 **Introduction:** very early maps of the area tend to be relatively lacking in detail and are certainly not specific enough to be useful in understanding the development of the property. The earliest useful maps are therefore only from the 19th century, although Jefferys' map of 1770 also provides some information in this case.

3.1.2 **Jefferys 1770:** this map, although not as detailed as those that follow, is of use as it clearly labels 'Fell Side' although only as a point rather than showing any specific detail. It is not therefore clear whether this represents a single building or close group of buildings, or what their exact form was, but it demonstrates the existence of the farm at this time.

3.1.3 **Estate Plan, 1801:** remarkably an early estate plan showing the site exists in the archives (CAC(K) WDB/35 1801). This is very detailed for its time and clearly shows the building had taken on much of its present form by this date (Plate 2).

3.1.4 **Tithe map, c1843:** the tithe map shows the layout of the building in more detail than the previous map, confirming the basic arrangement, but also showing an addition to the south-west section (Plate 3).

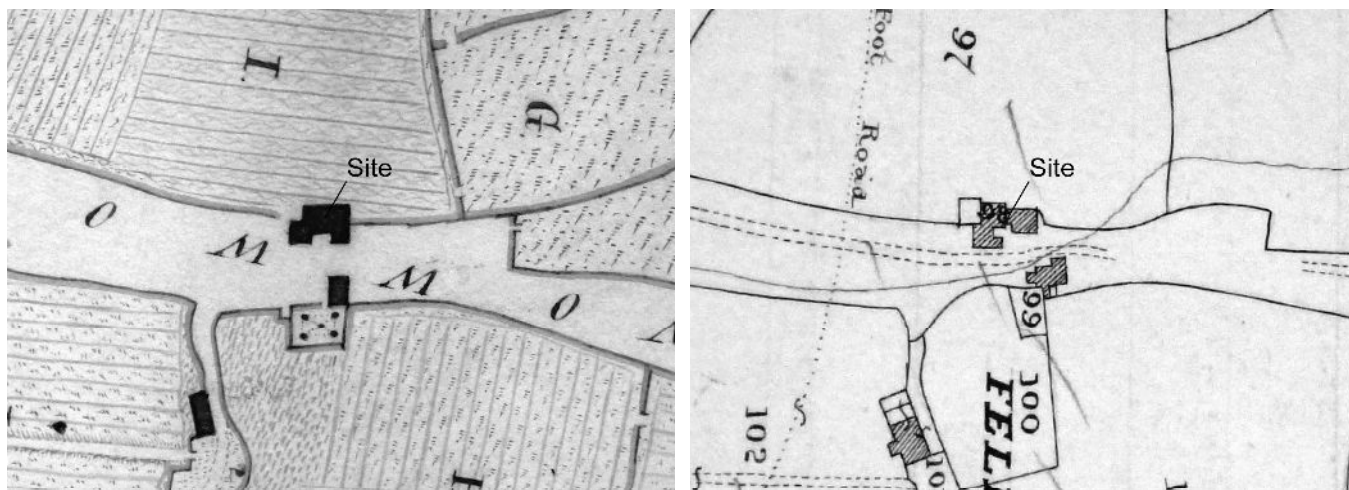

Plate 2 (left): Extract from the estate plan of 1801 (CAC(K) WDB/35 1801)

Plate 3 (right): Extract from the Tithe map of 1843 (CAC(K) WDRC/8/292 1843)

3.1.5 **Ordnance Survey, 1862:** the layout of the buildings is largely unchanged, although this plan is not as detailed as the previous and does not appear to show the small addition to the south-west (Plate 4).

3.1.6 **Ordnance Survey, 1898:** this is the first particularly detailed plan of the site but a similar arrangement is shown to the earlier plans (Plate 5). It is apparent that the building has essentially its present form, although without the extensions to the east end. The house on the opposite side of the road, by contrast, has evidently been substantially enlarged since 1862.



Plate 4 (left): Extract from the Ordnance Survey map of 1862

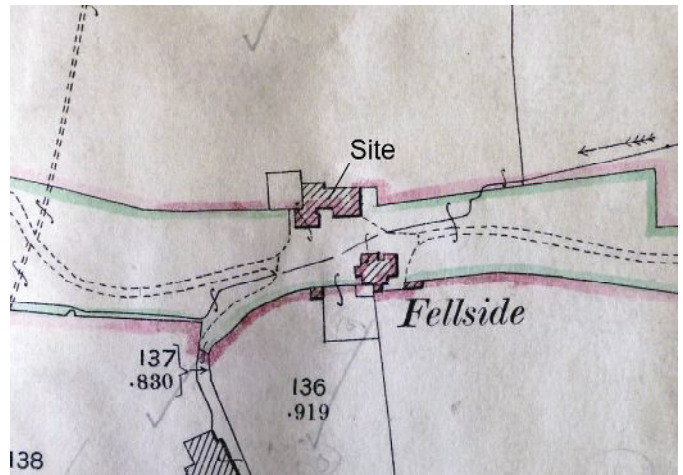

Plate 5 (right): Extract from the Ordnance Survey map of 1898

3.1.7 **Ordnance Survey, 1914:** this shows that relatively little has changed by this date, although an extension has been added to the east end of the building (Plate 6).

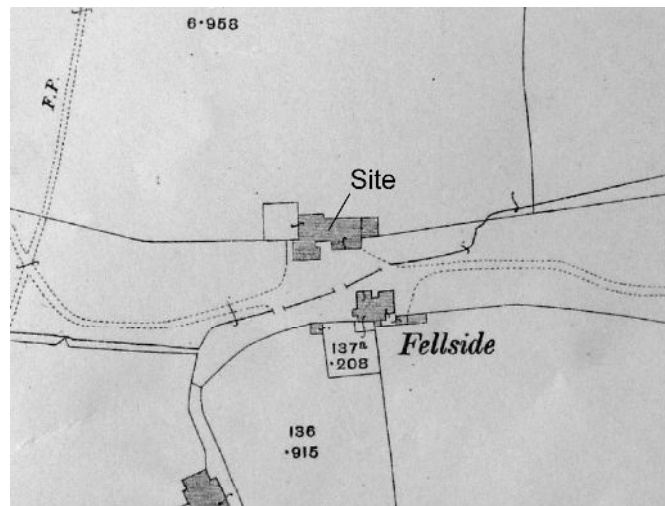

Plate 6: Extract from the Ordnance Survey map of 1914

3.2 Site History

3.2.1 **Introduction:** there is little specific historical information about the property prior to the 19th century. However, there is some confusion with another site in the same township, approximately 4km to the south, as both were earlier known simply as Fellside; they are now High Fellside and Low Fellside respectively. While Middleton was recorded in the Domesday Survey and several of the nearby settlements within the same parish (Middleton was a township in Kirkby Lonsdale parish) also have at least medieval origins it is unlikely that High Fellside is as early.

3.2.2 **Occupiers:** details of the people occupying the site cannot be ascertained with any certainty until the 19th century. The burial of a Jacob Gosling of 'Fel-side' is recorded in the parish registers for Middleton in 1677 (Haswell 1925, 61; Smith 1967, 55), but it is not clear which of the two Fellsides this is referring to. The earliest detailed directory for the area only lists one occupier at Fellside, a Joseph Tomlinson (Parson and White 1829, 697), so it is again uncertain whether this is a reference to the correct site. Other documentary sources are not plentiful until later in the 19th century, by which time it is easier to distinguish the two Fellsides, although these mostly relate to records of occupiers. A summary of these is presented in Table 1, below.

Date	Name	Occupier	Occupation	Source
1843	Fellside	John Ellwood	-	CAC(K) WDRC/8/292 1843
1879	Fellside	James Braithwaite	-	CAC(K) Microfilm JAC 649
1885	Fellside	Robert Braithwaite	Farmer	Bulmer 1885, 692
1894	Fellside	Robert Braithwaite	Farmer	Kelly and Co 1894, 108
1897	Fellside	Robert Braithwaite	Farmer	Kelly and Co 1897, 102
1905	Fellside	Robert Braithwaite	Farmer	Bulmer 1905, 544
1906	Fellside	Robert Braithwaite	Farmer	Kelly's Directories Ltd 1906, 104
1910	Fellside	Robert Braithwaite	Farmer	Kelly's Directories Ltd 1910, 108
1910	Fellside	Robert Braithwaite	-	CAC(K) WT/DV2/45 1910
1914	Fellside	Robert Braithwaite	Farmer	Kelly's Directories Ltd 1914, 108
1919	Fellside	Robert Braithwaite	-	CAC(K) WDB/35/SP97 1919
1921	Fellside	Robert Braithwaite	Farmer	Kelly's Directories Ltd 1921, 102
1925	Fellside	Caleb James Fletcher	Farmer	Kelly's Directories Ltd 1925, 102
1929	Fellside	John N Lancaster	Farmer	Kelly's Directories Ltd 1929, 99
1930	Fellside	Jane Eliza Lancaster	Farmer	The Westmorland Gazette 1930, 201
1934	Fellside	John N Lancaster	Farmer	Kelly's Directories Ltd 1934, 101
1938	Fellside	John N Lancaster	Farmer	Kelly's Directories Ltd 1938, 98

Table 1: Known occupiers of High Fellside recorded directories and other sources

3.2.3 The available census entries, from 1841 to 1901, also provide a considerable amount of additional information about the families occupying the farm during that time (*Appendix 1*). The earliest entry corresponds with the Tithe Map in being Thomas Ellwood and family, but following them two generations of the Braithwaite family occupy the site for at least 50 years, between 1851 and 1901. The first generation, Robert and his wife Sarah had at least nine children, including eight sons! In addition all of the census entries mention farm servants or labourers, latterly one with specific description of 'Cattle man' and this, combined with the acreages given show the size and productivity of the farm.

3.2.4 **Owners:** details of the owners are more difficult to ascertain, however, the Tithe Map (CAC(K) WDRC/8/292 1843) shows that at that time it belonged to Thomas Upton, whose family had been at Ingmire Hall near Sedbergh since the late 18th century (Nicholson and Burn 1777, 280). It clearly remained in the Upton family for some time as a JH Upton is described as owner in 1910 (CAC(K) WT/DV/2/45 1910) and in 1919 (CAC(K) WDB/35/SP97 1919), at which time the estate was being sold and so it presumably passed out of the family at this date.

3.2.5 **The Building:** the farm now known as High Fellside was certainly in existence by 1770 as it is shown on Jefferys' plan, although only labelled 'Fell Side', but it is clearly shown on the plan of 1801 (see *Section 3.1.2* and *3.1.3*) and had evidently taken much of its present form by that time. Some information regarding its development can be ascertained from the later maps (see *Sections 3.1.4-3.1.7*) but there are relatively few other sources of information that describe it. However, sales particulars from 1919 (CAC(K) WDB/35/SP97 1919) do provide a relatively detailed account:

'Lot 1 – Fellside Farm 235,858 Acres Arable, Meadow and Pasture Now in the occupation of Mr Robert Braithwaite.

The House with the outbuildings afford simple accommodation for the requirements of the Farm.

The House contains Kitchen, Parlour, Scullery, Dairy, Pantry, 4 Bedrooms, Attic.

The outbuildings consist of 3-stalled stable, Tying-up for 30 cows and 6 young beasts, 7 Calf Halls, 2 Large Barns, Granary, Root-shed, Store Room, Tool Shed, Cart Shed and Lofts'.

It is not clear whether all of these elements were contained within the building under consideration and some may have been included in the separate building across the road to the south-west.

3.3 Conclusion

3.3.1 The confusion in the documentary sources makes establishing the origin of the farm at what is now known as High Fellside difficult. The early reference, from 1677, cannot be certainly associated with

the site and is perhaps more likely to relate to what is now Low Fellside. The plan from 1770 confirms that the farm had been established by that date and it had clearly taken on much of its present form by 1801. The arrangement of the building remained largely unchanged following that date, although it is apparent from the later maps that further additions were made in the 19th and early 20th centuries.

4. Building Recording

4.1 Arrangement and Fabric

4.1.1 The building comprises a main central section, consisting of a large threshing barn, orientated east/west, on to which have been added a number of additions, primarily to the east end but also to the south-west (Figure 1). The main part is essentially a bank barn, built into the slope, with the lower end to the west, although it is not low enough to provide a full storey below the ground floor proper and so is only, in effect, a half bank barn. Some of the extensions to this structure have two storeys; while others are only small monopitch outshuts.

4.1.2 The entire building is constructed from a mixture of grey volcanic slate and grey or dark yellow sandstone, all of which is presumably locally derived. Pointing is largely with gravelly white lime mortar, although several areas have been repaired or largely rebuilt and these have used modern concrete mortar. The roof is finished with a mixture of grey slate and yellow flags, although corrugated metal sheeting is used on some of the smaller outshuts. Internally the stonework is typically exposed, although traces of lime mortar are present in many areas, and some brick has been used although largely only for later blocking. Floors are a mixture of stone flags, concrete and beaten earth on the ground floor, with timber floorboards typical on the upper floors, although stone flags have been used in the main threshing barn. The timber internally is largely hand-finished, with a considerable amount of re-used material, much of it evidently former cruck blades, although sawn timber is present in several places.

4.2 External Detail

4.2.1 **South elevation:** the east end is formed by what is now the side of a monopitch outshut, although it seems likely that this was originally a larger structure, perhaps gabled, as there are large quoins at the east end (Plate 7). To the west is a wagon doorway with a concrete lintel, the area above which has been extensively rebuilt, and a plank and batten double door. This section projects slightly from the wall to the west and the return to the north appears to be keyed in suggesting that the east outshut is butted against it. The adjoining section is two storeys in height, with a pedestrian doorway on the ground floor with a timber lintel and a plank and batten door and a first floor loading door above, but slightly to the east, with a timber lintel and surround, but with concrete over the sill. The wall then returns to the south to the west of this where there is a monopitch outshut extending across the full height of the elevation. The return of this is relatively plain (and actually forms part of the east elevation), while the south face has evidently been substantially repointed or rebuilt on the east side and there is a wagon doorway on the west with a timber lintel, with a stone drip course above, and the remains of a plank and batten double door (Plate 8). The west jamb of the doorway is constructed from large quoins and the wall returns to the north after this, forming the side elevation of the outshut. This wall butts against the wall of the barn proper, where there is a doorway with a dressed sandstone lintel, blocked with stone. The return of the wall to the west immediately forms a tall wagon doorway, with a porch over it (Plate 8 and Plate 10), the structure of which is constructed from a large slab of sandstone orientated east/west, supported on corbelled stone built into the outshut to the east, with timber joists supporting a stone flag roof. The doorway itself has a flat stone voussoir arch with a timber lintel below, a plank and batten double door, and there is some evident rebuild in the wall above. In the east jamb one of the quoins has graffiti carved into it including the initials 'JL', 'HL', 'HPD', and 'AB and the dates '1912'[?], '1939' and '1942' and at least one daisy wheel motif (Plate 9).



Plate 7 (left): East end of the south external elevation



Plate 8 (right): Central part of the south external elevation



Plate 9 (left): Graffiti in the jamb of the wagon doorway



Plate 10 (right): The wagon doorway and adjacent window in the centre of the south external elevation

4.2.2 The west jamb of the wagon doorway is formed by a return to the south, which extends beyond the line of the wall making the west end of the main part of the building wider than the east. This section is relatively plain, although there is a former doorway on the east side with a stone lintel, which has been partially blocked to form a window with a six-light timber casement and stone sill, and a blocked ventilation slot to the west of this with a massive stone lintel (Plate 10). Across this part of the elevation there are also numerous throughstones. At the west end of this section the remains of a stone staircase butt against the wall, topped with a large stone slab. The return to the south forms part of the east elevation (see *Section 4.2.5* below), while the west end of the south elevation comprises the gable end of the south-west section of the building (Plate 11). This is further extended on the east side by the side of a small monopitch outshut, which is plain apart from a vent at the junction between it and the gabled end, which it butts. The gabled section has quoined ends, although the upper part of the west side has been substantially rebuilt, and a plinth at the base, although this disappears into the slope to the east. There is an owl hole at the top with a projecting stone sill and lintel (effectively a drip course) and a small window low on the west side with a stone lintel and sill and a four-light timber casement.



Plate 11 (left): West end of the south external elevation



Plate 12 (right): General view of west external elevation

4.2.3 **West elevation:** the south side of this comprises the side elevation of the extension to the south-west of the main part of the building, and the north its gable end (Plate 12). The south side has quoins at the north and south ends, and a drip course, comprising two thin layers of stone, across the majority of the elevation at about first floor level. Below this, on the south side, is a doorway with a stone lintel and timber frame but no surviving door. This section returns to the east at its north end, where it forms part of the gable end (actually forming part of the north elevation), which is relatively plain although it has an aperture, presumably a low doorway, west of the centre with a rough timber lintel, which is blocked with stone (Plate 13). There is also what appears to be a small square vent above. At the return to the north this section evidently butts against the wall of the main part of the barn at ground floor level, but appears to have been roughly keyed in above. The north part of the elevation comprises the gable end of the main building, although the roof level has been raised slightly on the south side to meet the added south-west extension. There are several rows of throughstones high in the elevation, and on the ground floor level there is a doorway on either side, both with dressed sandstone lintels and plank and batten doors, with a small window in the centre between them, with a stone lintel, concrete sill and 1-light timber casement.



Plate 13 (left): Return in the centre of the west external elevation

Plate 14 (right): West end of the north external elevation

4.2.4 **North elevation:** the west end is relatively plain, although there are rows of through stones and two ventilation slots visible on the ground floor (Plate 14). The quoins at the west end are relatively small, while those at the return to the south are larger. The return meets a wagon doorway, opposing that in the south elevation, which also has a flat stone voussoir arch supported by a timber lintel (Plate 15). To the east of this the main part of the elevation has more rows of throughstones and a pair of ventilation slots on each floor and is finished with large quoins at the east end (Plate 16). Butting against these is a two storey extension, the upper level with a first floor aperture with a timber lintel, presumably a loading door, set against the end of the main barn and blocked with stone. There is a small window to the east of this at ground floor level with a stone lintel and sill and an incomplete timber casement with three lights remaining. This section is extended again to the east by a monopitch outshut, after a slight return in the wall to the south, which is relatively plain, although it has a window at the east end with a stone lintel.



Plate 15 (left): Wagon doorway in the centre of the north external elevation

Plate 16 (right): Centre and east end of the north external elevation

4.2.5 **East elevation:** the lower part of the main section is covered by the monopitch outshut, which is finished with corrugated sheet metal. The wall of this section is stone, built into the slope, and partially collapsing, with a timber wall plate on top supporting the roof. It is attached against the higher gable end of the section to the west, which is essentially plain, although the stone ridge time is topped with a flat base for a finial and the ends of the purlins project through the wall. There is a skim of concrete across the wall where the corrugated roof is joined to it (Plate 17). The east elevation is continued to the south by two additions projecting from the main wall, one to the east and one to the west. The eastern one comprises the side wall of the central monopitch outshut, and is described in *Section 4.2.1* above. The western one is the side of the large south-west extension, and has a doorway on the north side at the top of the flight of stone steps with a rough re-used timber lintel with a gap below above the surround for the door, which is of plank and batten construction. The main part of the elevation is relatively plain, with quoins at the south end, although the lower part is largely covered by a monopitch outshut with a corrugated sheet metal roof. This outshut has a doorway on its north side with a plank and batten door (Plate 18).

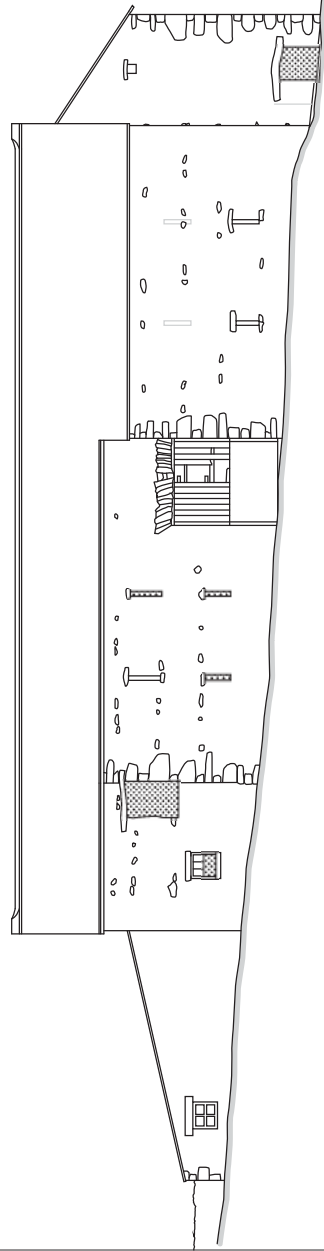

Plate 17 (left): General east end of the east external elevation

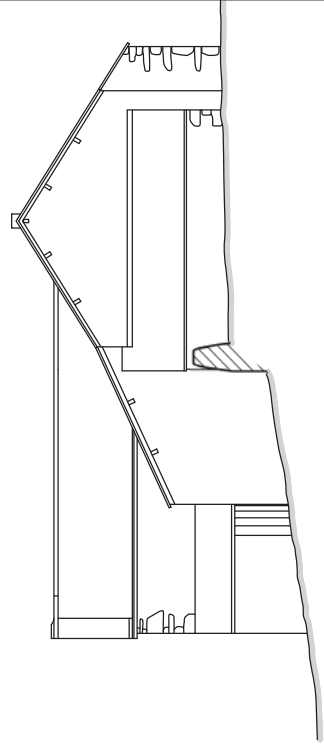

Plate 18 (right): Southern section of the east external elevation

NORTH ELEVATION



EAST ELEVATION



Elevation key:
 blocked feature
 cross-sectional wall
 visible from the inside only

PLAN OF THE LOWER LEVEL FEATURES

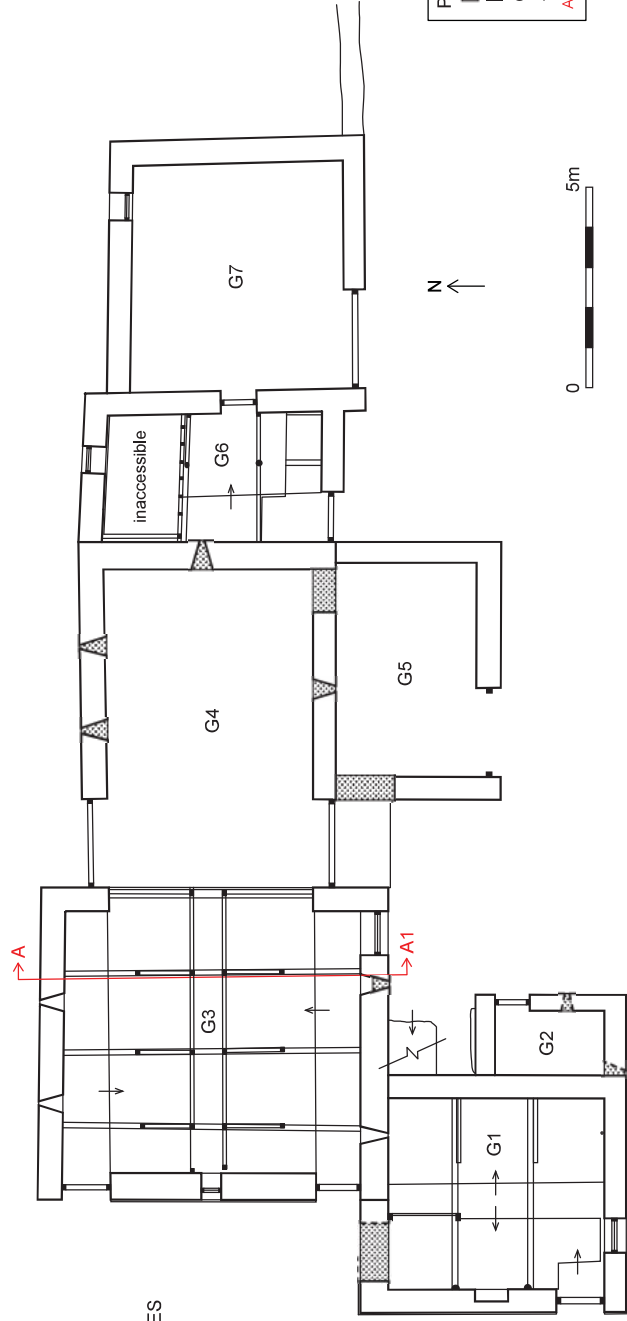

Plan key:
 blocked feature
 cross-sectional timber
 room number
 overhead features
 A1-A1 cross-section

Figure 2: North and east external elevations and plan of the lower level features

CROSS-SECTION A-A1

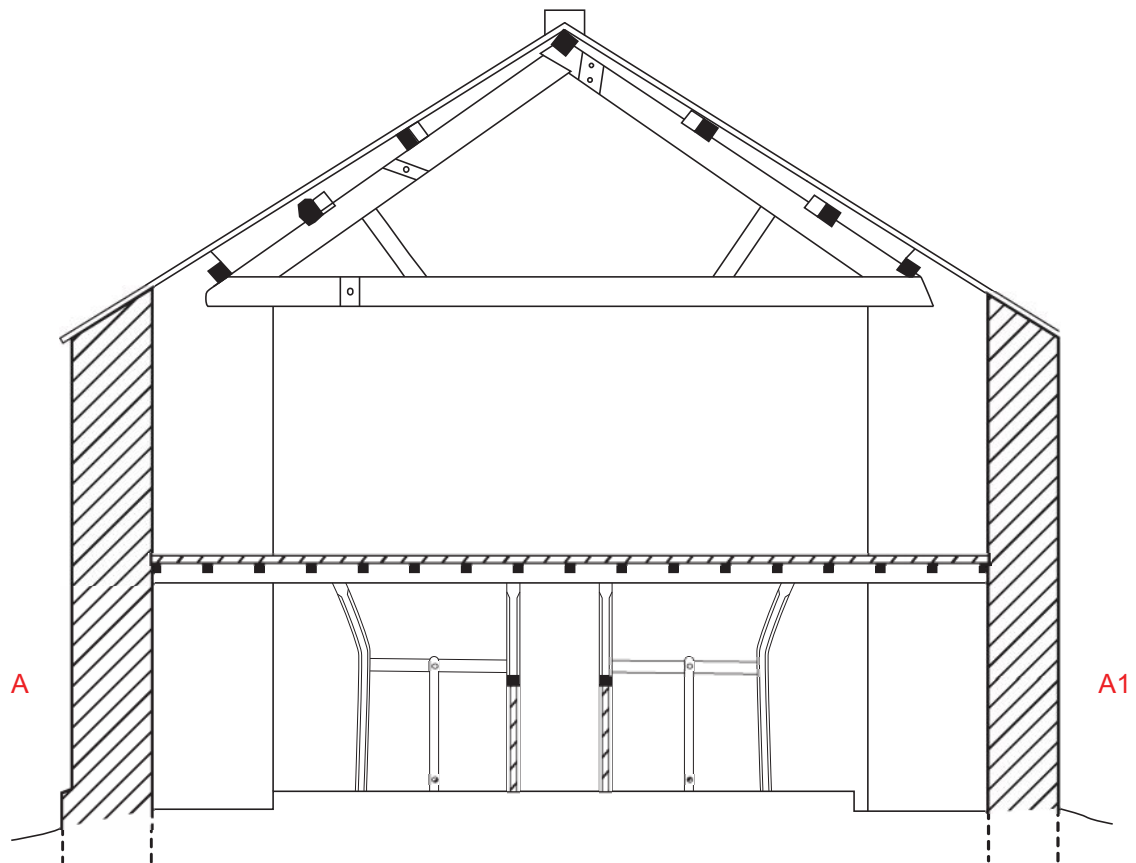

Key: ■ cross-sectional timber ▨ cross-sectional stone

4.3 Internal Detail

4.3.1 **Ground Floor Room 1:** this comprises the lower floor in the south-west extension. It has a concrete floor, which is raised against the east and west sides (more so to the east) forming a north/south dung channel, and is also stepped to the doorway in the south-west corner (Plate 19). There are two concrete stall partitions on the raised area to the east, against the east wall and a timber one on the north side of the room (Plate 20). The ceiling is supported by two roughly chamfered hand-finished east/west beams, the northern of which is supported by a chamfered post forming part of the timber stall partition. The joists of the ceiling are sawn, as are the floorboards they support. The walls are mostly exposed stone, although there is some limewash finishing the north and west elevations. The north elevation has a stall against the centre and a doorway on the west side, with a rough timber lintel, that is blocked with stone. The wall is built directly onto the slate bedrock in the centre and to the east. The east elevation is plain, apart from having two concrete stall partitions against it. The south elevation is also relatively plain, apart from a window to west, which has a rough timber lintel and a three-light timber casement, attached on top of the four-light casement visible externally. The west elevation has a doorway on the south side with a rough timber lintel and rebated timber frame. There is a further upright post against this elevation below each beam, and in the centre there is an alcove with a rough timber lintel, limewashed jambs and timber battens attached within for shelves, the remains of one of which survives (Plate 21).



Plate 19 (left): South-west corner of the Ground Floor Room 1

Plate 20 (right): Stall partitions in Ground Floor Room 1



Plate 21: Alcove in the west elevation of Ground Floor Room 1

4.3.2 Ground Floor Room 2: this is within the small monopitch outshut attached to the east of the south-west extension to the building. The floor is covered by wood chippings and other debris but appears to comprise stone flags. The walls are essentially plain and all exposed stone. There is a doorway on the north side of the east elevation with a stone lintel and plank and batten door, and there is a small splayed vent in the wall to the south of this (although this was not evident externally, suggesting that the wall has to some extent been rebuilt). The south elevation also a small vent with splayed jambs on the west side, against the west wall.

4.3.3 Ground Floor Room 3: this forms the west end of the main barn, and is at a lower level than the main room to the east (Ground Floor Room 4) but not actually an entire floors depth lower, as would be expected in a bank barn proper. It has a concrete floor, which is lower along the north and south sides to form east/west orientated dung channels. In the centre of the room there are three rows of stall partitions, either side of an east/west orientated feed channel (Plate 22). Both the stall partitions and the sides of the feed channel are constructed from timber posts and rails supporting upright stone slabs (Plate 23). Each stall partition has two posts, one at either end, which in turn support two north/south beams, which hold the joists of the floor above, which is constructed from stone flags. The posts are all stop chamfered, the outer ones on each side bend outwards, and within the stalls timber tether bars are bolted to the stone sides and metal water troughs with associated pipes are fixed to the central wall. The walls all have the remains of limewash over the rough stone. The north elevation is plain apart from two ventilation slots, which are covered with rough planking and there are three timber corbels projecting below the ceiling although not apparently supporting anything (Plate 24). The east elevation has masonry walls returning at either end but the central part is filled with more upright stone flags, set beneath a heavy timber beam, which is evidently reused and originally a cruck blade with two large empty joist slots (Plate 25). Below the beam a thick piece of timber has been attached to neaten the junction between the slabs and the beam, at either side there are timber posts performing the same function but perhaps also supporting the beam and in the centre there is a doorway with timber jambs, one with iron pintels, which is covered by a piece of chipboard in the room to the east. The south elevation has two vents with splayed jambs and stone lintels (Plate 26) and on the east side is a former doorway, partially blocked with stone to form a window with a six-light timber casement (Plate 27). It has a rough timber lintel and the sill is formed by machine made bricks finished with a concrete skim.

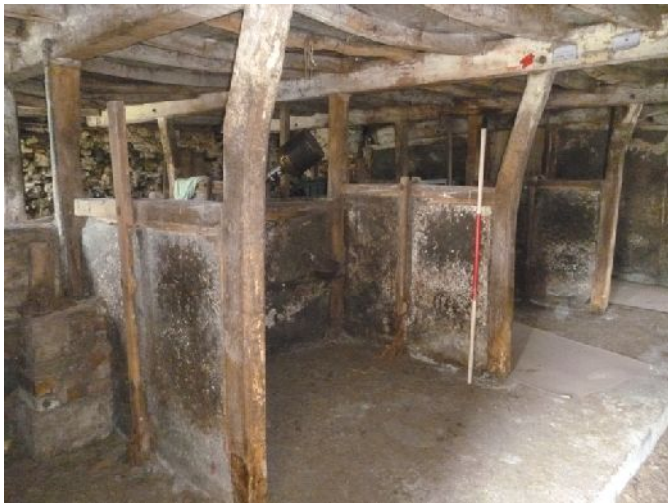

Plate 22 (left): Stall partitions in the Ground Floor Room 3

Plate 23 (right): Detail of the stall partitions in Ground Floor Room 3



Plate 24 (left): North elevation of Ground Floor Room 3

Plate 25 (right): East elevation of Ground Floor Room 3



Plate 26 (left): South elevation of Ground Floor Room 3

Plate 27 (right): Partially blocked doorway at the east end of the south elevation of Ground Floor Room 3

4.3.4 Ground Floor Room 4: this comprises the lower level of the main part of the threshing barn. It has a flag threshing floor in the entrance, which is raised on the east side with timber (perhaps re-used railway sleepers) and earth although it is covered with debris and pieces of timber. The room is open to the roof (see *Section 4.3.9*). The walls are exposed stone except on the west elevation, which is open to the roof above a rough timber lintel atop a wall of stone flags (Plate 28 and Plate 29). The edging strip below has graffiti carved into it, mostly pairs of initials (including an early form of 'W'). The north elevation has a wagon doorway on the west side with a re-used cruck forming the lintel and a double plank and batten door (Plate 30) to the east of which there are two blocked vent slots (Plate 31). The one to the east has a timber lintel. The east elevation forms the gable end, which is plain apart from a possible blocked vent in the centre (Plate 32). On the east side of the south elevation there is a blocked

doorway with a chamfered lintel (Plate 33) and there is a blocked vent to the west. Further to the west there is a plank and batten wagon door with a massive rough timber lintel, which may be a re-used cruck (Plate 34).



Plate 28 (left): West elevation of Ground Floor Room 4

Plate 29 (right): Detail of the stone partition on the ground floor with graffitied rail above



Plate 30 (left): Wagon door in the north elevation of Ground Floor Room 4

Plate 31 (right): Vent slots in the north elevation of Ground Floor Room 4



Plate 32 (left): The east elevation of Ground Floor Room 4

Plate 33 (right): Blocked doorway in the south elevation of Ground Floor Room 4



Plate 34: Doorway in the south elevation of Ground Floor Room 4

4.3.5 **Ground Floor Room 5:** this room probably has an earth floor but it is covered in debris. The walls are exposed stone and it has a monopitch roof with two machine cut purlins (see Plate 36). The north elevation has some throughstones and a vent slot near the centre and a doorway to the east which has a stone lintel and is blocked with stone (Plate 35). The east elevation is plain although it may have been rebuilt. The east side of the south elevation is plain and also might have been rebuilt. There is a large doorway to the west with a rough timber lintel above a machine cut lintel, but only the door frame remains. The west elevation has been rebuilt and the doorway on the north side has a timber lintel and is blocked with concrete blocks (Plate 36).



Plate 35 (left): North elevation of Ground Floor Room 5

Plate 36 (right): West elevation of Ground Floor Room 5

4.3.6 **Ground Floor Room 6:** this room has a concrete floor and a north/south aligned dung channel along the west side. A boarded area at the north end of the room is partitioned off by machine cut tongue and groove timber cladding (Plate 37). There are two stalls against the east elevation with round posts supporting the east/west aligned beams of the ceiling. The support beams are also rounded with random timbers laid on top comprising the ceiling. The walls are exposed stone with a rough lime mortar, which is covered by timber walling to the north. There is a central doorway on the east elevation with a plain surround and a rough timber lintel and an early looking plank and batten door hung on strap hinges (Plate 38). There is a doorway with a rough timber lintel and a square frame and plank and batten door with a single light on the west side of the south elevation (Plate 39). This elevation appears to butt against the east elevation. The west elevation has a central rough lintel, presumably for an aperture which is now blocked.



Plate 37 (left): North elevation of Ground Floor Room 6

Plate 38 (right): Doorway on the east elevation of Ground Floor Room 6



Plate 39: Doorway in the south elevation of Ground Floor Room 6

4.3.7 **Ground Floor Room 7:** this room has an earth floor, exposed stone walls, and a monopitch roof made from corrugated metal. The roof is supported by a single east/west beam and six timber purlins, all machine cut timber. The north elevation has a large timber trough against it supported on two timber corbels set into the wall with additional support under the east end corbel (Plate 40). The window at the east end has a rough timber lintel and six-light casement roughly fixed over. The east elevation is plain. There is a wide doorway on the west side on the south elevation, with a concrete lintel and a plank and batten double door, with some rebuilding work evident above (Plate 41). The west elevation has a central doorway with a voussoir stone arch and a rough timber lintel and plank and batten door (Plate 42). The west elevation is butted by the north elevation.



Plate 40 (left): North elevation of Ground Floor Room 7

Plate 41 (right): West end of the south elevation of Ground Floor Room 7



Plate 42 (left): West elevation of Ground Floor Room 7



Plate 43 (right): South end of First Floor Room 1

4.3.8 First Floor Room 1: this room is located above Ground Floor Room 1 but is not fully accessible due to the poor condition of the timber board floor. The room is open to the roof and has a single simple tie beam truss, with lap jointed principals and three purlins per pitch and a diagonal ridge (Plate 43). All the timber is hand-finished. The walls are exposed stone with thick lime mortar. The elevations are mostly plain. There is a doorway with a roughly chamfered timber lintel above a gap over the door frame proper, which is stop-chamfered and houses a plank and batten door on the north side of the east elevation and there is a high level owl hole in the south elevation.

4.3.9 First Floor Room 2: this room comprises the open area above Ground Floor Room 3 and 4, the main part of the threshing barn. The space is open to the ground floor at the east end and is wider at the west end, above Ground Floor Room 3, where it has a stone flag floor which is thought likely to be hazardous in its current condition (Plate 44). The room is open to the roof and has a single tie beam truss at the west end (above Ground Floor Room 3) with a collar and a single angled brace on the north side (Plate 45). All the timbers of the trusses are peg-jointed and the principals are lap-jointed together, the south sitting on top of the north. There are carpenter's marks ('IIII') at the junction between the brace and the principal. The truss is hand-finished and there are three purlins per pitch, apparently later replacements, with wedges and additional sawn timbers below. There are three trusses to the east, at the narrower end of the room, effectively above Ground Floor Room 4. These are all tie beam with a pair of angled braces (Plate 46 and Plate 47). There are carpenter's marks, which read 'I', 'II', and 'III' from east to west, at the junctions between the brace and principals and all the joints are pegged and the timbers are hand-finished. The third west of the three trusses with angled braces has '1711' chiselled into the east face of the tie beam (Plate 48). There are two purlins per pitch for the most part and a diagonally set ridge purlin, which are hand-finished, and the rafters are machine cut. Most of the trusses are made of re-used cruck fragments. The walls are all exposed stone with a thick lime mortar. The north elevation has two blocked vents in the west section and two more in the east section, one of which is open, and one has a timber lintel. The two to the west both have timber lintels. The east elevation has a single vent slot at about mid-height and an owl hole above (which is still in use). The south elevation has two vent slots in the east and west ends, with a mix of stone and timber lintels. The west elevation is plain, with a plaster finish, which is very rough, with some rebuilding apparent below the purlins.



Plate 44 (left): South-west corner of First Floor Room 2



Plate 45 (right): Truss above the west end of First Floor Room 2



Plate 46 (left): General view of the trusses in First Floor Room 2, looking west



Plate 47 (right): Detail of the easternmost truss in First Floor Room 2



Plate 48: '1711' chiselled into the truss

4.3.10 **First Floor Room 3:** the room above Ground Floor Room 6 is not accessible due to the condition of the rough floor which is made from odds and ends of timber and corrugated sheeting. The room is open to the roof and has two sawn purlins per pitch, spanning between the east and west walls, and a diagonally set ridge. The walls are exposed stone with a rough lime mortar. The north elevation has an aperture with a rough timber lintel on the west side. The opening is blocked with stone. The east elevation is plain. There is an off-centre aperture on the west side of the south elevation with a rough

timber lintel and a square frame. The west elevation is plain apart from an owl hole at the top and some throughstones and a vent slot is visible.

5. Discussion

5.1 Phasing

5.1.1 **Introduction:** the building clearly retains a considerable amount of original fabric but has also undergone a number of alterations and modifications. In total, five phases of development were identified, most of which can be dated quite accurately either because of the detailed early mapping or because of features within the building.

5.1.2 **Phase 1 (early 18th century):** the earliest element of the building evidently comprises a large combination variant bank barn, with a cow house (or byre) in the lower west end and threshing floor and associated storage in the east end and over the cow house. The form of the barn is of interest as its wider west end, incorporating two access doors into the cow house, is a variant of the Lancashire barn (Brunskill 2007, 111-113) but with both sides extending beyond the width of the threshing floor, rather than just one. In this respect it is identical to two buildings also recorded in the upper Lune Valley; at Thompson Fold in Lupton (Greenlane Archaeology 2008), and Drybeck Farm in Killington (Greenlane Archaeology 2011). The dating of this phase is likely to correspond to the date chiselled into the truss, 1711. This fits very well with the example at Thompson Fold, which is thought to shortly post-date the earliest phase at that site dated by a datestone to 1701. The documentary evidence for High Fellside certainly confirms that this phase of the barn was complete by 1801. The presence of re-used cruck blades throughout the roof and other elements belonging to this phase might indicate that an earlier building was present on the site that was demolished and the materials re-used, but it cannot be stated with any certainty that this was the case and the timber could have come from much further afield. The reuse of materials from demolished buildings was commonplace throughout the 17th and 18th centuries (Tyson 2000) and so is not particularly remarkable in this case.

5.1.3 **Phase 2 (late 18th century):** the estate plan of 1801 clearly shows that by this date two additions had been made to the building, the two storey extension to the south-west (comprising Rooms G1 and F1) and the monopitch outshut to the east of the centre of the south elevation (comprising Room G5). The south-west extension was presumably intended to provide a granary on the top floor, with increased animal housing below, while the monopitch extension was perhaps intended as a stable, loose box or cart shed, although it has few distinguishing features.

5.1.4 **Phase 3 (early 19th century):** the mapping evidence shows that between 1801 and 1843 only a minor addition was made, a small monopitch outshut on the east side of the earlier south-west elevation. This almost certainly formerly formed a loose box or similar, and, with the earlier additions, shows a general increase in emphasis towards housing cattle and dairy farming. This is certainly something that is known to have been a general trend in this period, as a result of the increased demand for dairy products during the Industrial Revolution (Brunskill 2007, 67).

5.1.5 **Phase 4 (late 19th – early 20th century):** the latest Ordnance Survey map examined shows clearly that a further extension was added to the east between 1898 and 1914. This corresponds to Rooms G6 and F3, and probably provided further animal housing and storage on the first floor, perhaps for hay, which was most likely loaded through the apertures on the north and south sides. Some alterations may also have been carried out elsewhere during this period. The style of brick used in the blocking of the doorway into Room G3 suggests a late 19th or early 20th century date, and this may correspond with the addition of concrete floors with dung channels in Rooms G1 and G3. These must have been later additions since concrete was not available when the building was first constructed, although it is unclear how this could have been added later and whether that means that the stalls were rebuilt as a result. Clearly the concrete stalls in Room G1 are a later addition, probably of this period. Many of the ventilation slots around the building were probably also blocked during this phase or earlier, again as a result of the building being used primarily if not exclusively for housing cattle rather than threshing and storing corn.

5.1.6 **Phase 5 (20th century – early 21st century):** the map evidence shows that the extension to the east end of the building (comprising Room G7) was added after 1914. It is possible that this corresponds to the 'root store' listed in the sales particulars of 1919; the large timber trough perhaps indicating that

the building was used for feeding animals. If this is the case it must have been built shortly after 1914. The rest of this phase is typified by further minor alterations and a general decline in condition of the building, which resulted in some recent repair to prevent collapse (Mike Smith pers comm.). The wide doorway in Room G7 is clearly a later modification, perhaps to turn this building into a garage. Any remaining open ventilation slots were probably also blocked during this period, although some remain open, and rebuilding or repair work was carried out to the outshut housing Room G5 and the south-west corner of the south-west extension.

5.2 Significance

5.2.1 The building represents another good example of what appears to be a local variation of a Lancashire Barn and variant bank barn, something that was probably once quite common in the area. The early detailed map of the site and the apparent date chiselled into the truss both provide very useful evidence in terms of dating its initial construction, almost certainly in 1711, which is relatively unusual in buildings of this type.

5.2.2 It is also worth noting that the original farmhouse was demolished without recording in 2007 before the present house was built. Had a requirement been made to record this too a much more useful record of the whole farmstead would have ultimately been available.

6. Bibliography

6.1 Primary and Cartographic Sources

CAC(K) WDRC/8/292, 1843 *Plan of the Enclosed Lands of the Township of Middleton in the Parish of Kirkby Lonsdale and County of Westmorland*

CAC(K) WDB/35, 1801 *Plan: Fell-Side, Raismere Side, Beckside-Hall and Hold in Middleton*

CAC(K) WDB/35/SP97, 1919 *Sales Particulars: The Middleton Estate of Major JH Upton*

CAC(K) WT/DV/2/45, 1910 The Commissioners of Inland Revenue, 1910 *Duties on Land Values: Record of Valuations made by the Commissioners of Inland Revenue, in accordance with the provisions of Part I. of the Finance (1909/10) Act, 1910. County of Westmorland Division of Lonsdale Ward. A Valuation Book for the Parish or Place of Middleton*

CAC(K) Microfilm JAC 649 *Register of Wills 1879*

HO 107/1161/12, 1841 *Census Return*

HO 107/2441, 1851 *Census Return*

Jefferys, T, 1770 *The County of Westmorland Surveyed*

Ordnance Survey, 1862 *Westmorland Sheet 40*, 1: 10,560, surveyed in 1858

Ordnance Survey, 1898 *Westmorland Sheet 40.13*, 1: 2,500, revised in 1896

Ordnance Survey, 1914 *Westmorland Sheet 40.13*, 1: 2,500, revised in 1907

Ordnance Survey, 2005 *Yorkshire Dales Southern & Western Areas: Showing Whermside, Ingleborough, Pen-y-ghent, Pennine Way and Part of the National Park, OL2*, 1:25,000

RG 9/3968, 1861 *Census Return*

RG 10/5284, 1871 *Census Return*

RG 11/5211, 1881 *Census Return*

RG 12/4331, 1891 *Census Return*

RG 13/4910, 1901 *Census Return*

6.2 Secondary Sources

Brown, DH, 2007 *Archaeological Archives: A Guide to Best Practice in Creation, Compilation, Transfer, and Curation*, IfA, Reading

Brunskill, RW, 2007 *Traditional Farm Buildings of Britain*, 4th edn, London

Bulmer, TF (ed), 1885 *History, Topography and Directory of Westmorland*, Manchester

Bulmer, T, (ed), 1905 *History, Topography, and Directory of Westmorland*, Preston

Countryside Commission, 1998 *Countryside Character, Volume 2: North West*, Cheltenham

English Heritage, 1991 *The Management of Archaeological Projects*, 2nd edn, London

English Heritage, 2006 *Understanding Historic Buildings: A Guide to Good Recording Practice*, Swindon

Greenlane Archaeology, 2008 *Thompson Fold, Lupton, Cumbria: Archaeological Building Recording*, unpubl rep

Greenlane Archaeology, 2010 *Drybeck Farm, Killington, Cumbria: Archaeological Building Recording*, unpubl rep

Haswell, JF (trans), 1925 *The Registers of Middleton-in-Lonsdale, Westmorland, 1670-1812*, Penrith

- Institute for Archaeologists (IfA), 2008a *Standards and Guidance for the Archaeological Investigation and Recording of Standing Buildings or Structures*, revised edn, Reading
- IfA, 2008b *Standard and Guidance for Archaeological Desk-Based Assessment*, revised edn, Reading
- Kelly and Co Ltd, 1894 *Kelly's Directory of Cumberland and Westmorland*, London
- Kelly and Co Ltd, 1897 *Kelly's Directory of Cumberland and Westmorland*, London
- Kelly Directories Ltd, 1906 *Kelly's Directory of Cumberland and Westmorland*, London
- Kelly Directories Ltd, 1910 *Kelly's Directory of Westmorland*, London
- Kelly's Directories Ltd, 1914 *Kelly's Directory of Westmorland*, London
- Kelly's Directories Ltd, 1921 *Kelly's Directory of Cumberland and Westmorland*, London
- Kelly's Directories Ltd, 1925 *Kelly's Directory of Cumberland and Westmorland*, London
- Kelly's Directories Ltd, 1929 *Kelly's Directory of Westmorland*, London
- Kelly's Directories Ltd, 1934 *Kelly's Directory of Cumberland and Westmorland*, London
- Kelly's Directories Ltd, 1938 *Kelly's Directory of Cumberland and Westmorland*, London
- Moseley, F. (ed), 1978 *The Geology of the Lake District*, Yorkshire Geological Society, occ publ **3**, Leeds
- Nicholson, J, and Burn, R, 1777 *The History and Antiquities of the Counties of Westmorland and Cumberland*, Vol 1, London
- Parson, W, and White, W, 1829 *History, Directory, and Gazetteer of the Counties of Cumberland and Westmorland, with that part of the Lake District in Lancashire, Forming the Lordships of Furness and Cartmel*, Leeds
- Smith, AH, 1967 *The Place-Names of Westmorland: Part 1 Introduction River- & Lake-Names, Road-Names, the Barony of Kendal*, Cambridge
- Tyson, B, 2000 *Management Attitudes Towards Reusing Materials in Traditional Cumbrian Buildings, Vernacular Architecture*, **31**, 32-44
- Westmorland Gazette, The, 1930 *The Westmorland Directory, Year Book and Diary*, Kendal

Appendix 1: Details from the Census Returns, 1841-1901

1841 Census HO 107/1161/12				
Name	Age	Occupation	Address	Place of Birth
John Ellwood	49	Farmer	Fellside	Westmorland
Mary Ellwood	48	-	Fellside	Westmorland
Elizabeth Ellwood	20	-	Fellside	Westmorland
John Ellwood	16	-	Fellside	Westmorland
Margaret Ellwood	12	-	Fellside	Westmorland
Hannah Ellwood	8	-	Fellside	Westmorland
Agnes Ellwood	6	-	Fellside	Westmorland
William Atkinson	27	Male servant	Fellside	Westmorland
Mary Moreland	32	Female servant	Fellside	Westmorland

1851 Census HO 107/2441				
Name	Age	Occupation	Address	Place of Birth
James Braithwaite	39	Farmer of 500	Fellside	Yorkshire, Sedbergh
Sarah Braithwaite	42	Farmer's wife	Fellside	Yorkshire, Sedbergh
Thomas Braithwaite	19	Farmer's son, employed on farm	Fellside	Yorkshire, Sedbergh
John Braithwaite	17	Farmer's son, employed on farm	Fellside	Yorkshire, Sedbergh
James Braithwaite	15	Farmer's son, employed on farm	Fellside	Yorkshire, Sedbergh
Richard Braithwaite	12	Farmer's son	Fellside	Yorkshire, Sedbergh
Matthew Braithwaite	10	Scholar	Fellside	Yorkshire, Sedbergh
William Braithwaite	8	Scholar	Fellside	Yorkshire, Sedbergh
Robert Braithwaite	4	-	Fellside	Westmorland, Middleton
George Braithwaite	1	-	Fellside	Westmorland, Middleton
George Fawcett	36	Farm labourer	Fellside	Yorkshire, Sedbergh
Jane Crawford	25	House servant	Fellside	Westmorland, Middleton
John Dodgson	64	Farm labourer	Fellside	Yorkshire, Sedbergh
Ann Handley	20	House servant	Fellside	Yorkshire, Sedbergh
Ann Braithwaite	56	Visitor	Fellside	Yorkshire, Sedbergh

1861 Census RG 9/3968				
Name	Age	Occupation	Address	Place of Birth
James Braithwaite	50	Farmer of 170 acres	Fellside	Yorkshire, Sedbergh
Sarah Braithwaite	53	Farmer's wife	Fellside	Yorkshire, Sedbergh
James Braithwaite	25	Farmer's son	Fellside	Yorkshire, Sedbergh
William Braithwaite	18	Farmer's son	Fellside	Yorkshire, Sedbergh
Jane Braithwaite	16	Farmer's daughter	Fellside	Yorkshire, Sedbergh
Robert Braithwaite	14	Scholar	Fellside	Westmorland, Middleton
Henry Braithwaite	10	Scholar	Fellside	Westmorland, Middleton
Sarah Braithwaite	6	Scholar	Fellside	Westmorland, Middleton

1871 Census RG 10/5284				
Name	Age	Occupation	Address	Place of Birth
James Braithwaite	59	Farmer of 200 acres	Fellside	Yorkshire, Sedbergh
Sarah Braithwaite	62	Farmer's wife	Fellside	Yorkshire, Sedbergh
William Braithwaite	28	Farmer's son	Fellside	Yorkshire, Sedbergh
Robert Braithwaite	24	Farmer's son	Fellside	Westmorland, Middleton
Sarah Braithwaite	16	Farmer's daughter	Fellside	Westmorland, Middleton
Ellen Bowman	17	General servant/domestic	Fellside	Yorkshire, Dent
Henry Braithwaite	22[?]	Grocer	Fellside	Westmorland, Middleton

1881 Census RG 11/5211				
Name	Age	Occupation	Address	Place of Birth
Robert Braithwaite	34	Farmer of 226 acres	Fellside	Westmorland, Middleton
Sarah Braithwaite	73	Annuitant	Fellside	Yorkshire, Sedbergh
James Braithwaite	41	Farm servant, indoor	Fellside	Yorkshire, Sedbergh
Sarah Braithwaite	26	-	Fellside	Westmorland, Middleton
Isabella Fisher	19	Domestic servant	Fellside	Westmorland, Kirkby Lonsdale
Thomas Atkinson	17	Farm servant, indoor	Fellside	Westmorland, Kirkby Lonsdale

1891 Census RG 12/4331				
Name	Age	Occupation	Address	Place of Birth
Robert Braithwaite	44	Farmer	Fellside	Westmorland, Middleton
Mrs Hayton	38	Housekeeper	Fellside	Westmorland, Barber Green
William Wilkinson	23	Farm servant	Fellside	Westmorland, Kirkby Lonsdale
Samuel Saxton	22	Farm servant	Fellside	Westmorland, Kirkby Lonsdale
Margaret Morris	16	General servant	Fellside	Lancashire, Carnforth
William Thistlethwaite	15	Farm servant	Fellside	Westmorland, Shap

1901 Census RG 13/4910				
Name	Age	Occupation	Address	Place of Birth
Robert Braithwaite	54	Farmer	Fellside (North)	Westmorland, Middleton
Thomas Park	17	Journeyman on farm	Fellside (North)	Westmorland, Lyth
George Dunncliff	21	Cattleman on farm	Fellside (North)	Staffordshire, Stoke
Margaret Dixon	14	General servant (domestic)	Fellside (North)	Westmorland, Kendal