



INDEX DATA	RPS INFORMATION
Scheme Title M25 link roads junctions 12-15	Details Archaeological Field Evaluation Technical Report
Road Number M25	Date April 1994
Contractor Oxford Archaeological Unit	
County Surrey	
OS Reference TQ06	
Single sided <input checked="" type="checkbox"/> Double sided A3 <input type="checkbox"/> Colour <input type="checkbox"/>	

m25 (B2)
M25 LINK ROADS BETWEEN JUNCTIONS 12 AND 15

ARCHAEOLOGICAL FIELD EVALUATION

TECHNICAL REPORT

OXFORD ARCHAEOLOGICAL UNIT

APRIL 1994

CONTENTS	PAGE
SUMMARY	1
1.0 INTRODUCTION TO THE REPORT	3
2.0 THORPE FIELDS	6
3.0 LAND WEST OF THORPE BYPASS	10
4.0 LAND BETWEEN LONGSIDE LAKE AND GREAT FOSTERS	12
5.0 LAND NORTH OF WICKHAM LANE	14
6.0 UNIGATE DAIRIES (PETTERS SPORTS FIELD)	19
7.0 LAND WEST OF QUEENSMEAD LAKE	22
8.0 YEOVENEY LODGE	24
9.0 CAMBRIDGE KENNELS	29
10.0 POYLE MEADOWS	35
REFERENCES	37
FIGURES	
1-2 General location of the evaluation sites	
3 Thorpe Fields, trench locations	
4 Thorpe Fields, plan and section, Trench 23	
5 Land west of Thorpe Bypass, trench locations	
6 Land between Longside Lake and Great Fosters, trench locations	
7 Land north of Wickham Lane, trench locations	
8 Land north of Wickham Lane, plan and sections, Trench 2	
9 Land north of Wickham Lane, plan and sections, Trench 3	
10 Land north of Wickham Lane, plan and section, Trench 6	
11 Land north of Wickham Lane, section of ditch 9, Trench 6	
12 Unigate Dairies (Petters Sports Field), trench locations	
13 Unigate Dairies (Petters Sports Field), plan and section, Trench 100	
14 Land west of Queensmead Lake, trench locations	

- 15 Land west of Queensmead Lake, plan and section, Trench 71
- 16 Yeoveney Lodge, trench locations
- 17 Yeoveney Lodge, plan and sections, Trench 82
- 18 Cambridge Kennels, trench locations
- 19 Cambridge Kennels, plans and section, Trench 30
- 20 Cambridge Kennels, plan and section, Trench 35
- 21 Cambridge Kennels, plan, Trench 36
- 22 Cambridge Kennels, plan and section, Trench 38
- 23 Poyle Meadows, trench locations
- 24 Poyle Meadows, plan, Trench 42

TABLES

- 1 Thorpe Fields, flint typology
- 2 Thorpe Fields, context details
- 3 Land west of Thorpe Bypass, context details
- 4 Land between Longside Lake and Great Fosters, context details
- 5 Land north of Wickham Lane, flint typology
- 6 Land north of Wickham Lane, context details
- 7 Unigate Dairies (Petters Sports Field), context details
- 8 Land west of Queensmead Lake, context details
- 9 Yeoveney Lodge, flint typology
- 10 Yeoveney Lodge, context details
- 11 Cambridge Kennels, environmental sample details
- 12 Cambridge Kennels, details of seeds from samples 1 and 3-5
- 13 Cambridge Kennels, details of molluscs in samples 3 and 4
- 14 Cambridge Kennels, context details
- 15 Poyle Meadows, context details

SUMMARY

The Oxford Archaeological Unit (OAU) was commissioned by Chris Blandford Associates (on behalf of the Department of Transport) to undertake a programme of field evaluation on nine sites between Junctions 12 and 15 on the M25 motorway. The fieldwork represented the stage 3 evaluation of proposed link roads and associated works between Junctions 12 and 15, in line with Volume 11 of the *Design Manual for Roads and Bridges* (DoT, 1993). The evaluated sites are: Thorpe Fields; land west of the Thorpe Bypass; land between Longside Lake and Great Fosters; land north of Wickham Lane; the Unigate Dairies; land west of Queensmead Lake; Yeoveney Lodge; Cambridge Kennels; and Poyle Meadows.

The evaluation at Thorpe Fields comprised the excavation of six trial-trenches in an area currently given over to public open space and a copse. The only archaeological feature to be located was a single ditch containing flint flakes and small fragments of prehistoric pottery. Although no archaeological features were located in the south half of the site several flint flakes and a piece of burnt flint were retrieved from a buried soil horizon in two of the trenches. Excavation of test-pits on land west of the Thorpe Bypass and an area between Longside Lake and Great Fosters showed that mineral extraction had taken place on both sites, and that their archaeological potential was therefore minimal.

The evaluation of land north of Wickham Lane, Egham, comprised the excavation of 12 trial-trenches. Several ditches were found in the area to the west of the motorway. A small assemblage of neolithic or bronze age flint flakes and pieces of burnt flint was associated with these features. An area of alluvium was also noted; the alluvium sealed one of the ditches. No significant archaeological deposits were located in the area to the east of the motorway.

The evaluation of the Unigate Dairies site (formerly Petters Sports Field), Egham, comprised the excavation of two trial-trenches, one each to the north and south of an area which had already been archaeologically excavated. A single ditch, containing modern artefacts, was located in the trench through the north-east area of the site. No archaeological features were found in the trench through the south half of the site.

The evaluation of land at Queensmead Lake, Wraysbury, Berkshire, comprised the excavation of five trial-trenches/test-pits. The site is overgrown, and trenches could only be excavated in the few clearances where major trees did not exist. Furthermore a considerable depth of overburden was

present at the southern end of the site (nearly 2 m). The depth of overburden was mostly due to a build-up of alluvium, but modern dumping was also present. Similar, but much shallower deposits were observed in the trenches in the central and northern areas of the site. No archaeological deposits were located in any part of the site.

The evaluation of the land at Yeoveney Lodge, in the parishes of Spelthorne, Surrey, and Wraysbury, Berkshire, comprised the excavation of one trial-trench and three test-pits. Test-pits excavated on the line of the original A30 Staines Bypass, which ran through the length of the site (see Figure 16), showed that the road had been scoured deep into the original landscape. Its construction would have severely truncated or destroyed any archaeological remains in its path. A test-pit excavated in a small area in the south-west corner of the site, unaffected by the road, showed that this area had also been subjected to deep modern disturbance. A trial-trench through a triangular area of land in the north-east corner of the site (formed between the line of the original road A30 and the present road) not only established that this area survives undisturbed, but also located archaeological remains. The remains consisted of a ditch containing burnt and struck flints probably of bronze age date, and a few small sherds of prehistoric pottery, a possible pit and a posthole.

The evaluation of the land at the Cambridge Kennels, Spelthorne, Surrey, comprised the excavation of nine trial-trenches. A palaeo-channel (ancient river bed) containing pieces of preserved worked wood was located running through the western half of the site. Two ditches, also containing waterlogged material, were found in the area immediately to the west of the palaeo-channel. No datable finds were retrieved either from the palaeo-channel or from the ditches. Environmental evidence, however, is consistent with a later prehistoric or earlier historic date. No significant archaeological deposits were located in the eastern half of the site, where extensive modern disturbance (landscaping), was observed throughout.

The evaluation of the land at the Poyle Meadows, Spelthorne, comprised the machine-excavation of a series of test-pits. These established that gravel extraction had taken place virtually throughout the site.

1.0 INTRODUCTION TO THE REPORT

1.1 This report describes in detail the results of nine archaeological site evaluations carried out along the line of the proposed M25 link roads between Junctions 12 and 15. The fieldwork was carried out by the Oxford Archaeological Unit, commissioned by Chris Blandford Associates on behalf of the Department of Transport (DoT). The work formed part of an assessment of the impact on known and/or potential archaeological sites of the scheme. The impact of the scheme would vary depending upon the nature and scale of road construction, soil mounding and landscape measures. This report represents the stage 3 fieldwork evaluation in line with Volume 11 of the *Design Manual for Roads and Bridges* (DoT 1993), which states that field evaluation can be undertaken where there is insufficient evidence to accurately determine the impact of a scheme. The results of this fieldwork have been incorporated into the Environmental Statement (Volume 1 and Volume 2, Report 12 Cultural Heritage). The aim of the evaluations was to establish the presence and degree of preservation of any archaeological deposits, and to determine their extent and date range.

1.2 A desk study identified a number of areas of archaeological potential which could be affected by the scheme, as well as areas which had already been truncated or destroyed by earlier developments such as mineral extraction.

1.3 Sites were selected for field evaluation on the basis of the desk study. The selection criteria for evaluation were based on four principal concerns:

- 1 The extent to which existing information covered by the desk study provided a sufficient basis for assessing the likely impact of the proposals;
- 2 The extent and nature of the impact of the proposals (eg road construction, soil mounding, landscaping including tree plantation);
- 3 The potential for significant archaeological deposits to survive, based on the desk assessment of geotechnical and other information (including consideration of areas already truncated or destroyed);
- 4 Areas where the recent land history, and therefore the potential for surviving

archaeology, was unclear.

- 1.4 The desk study, including the proposed scope of field evaluation, was seen by English heritage and the County Archaeological Officers (or their equivalents) in October 1993.
- 1.5 Detailed archaeological Written Schemes of Investigation (WSIs) were prepared for the proposed field evaluations, as defined in the Department of the Environment's *Planning and Policy Guidance: Archaeology and Planning* (PPG 16, November 1990, paragraph 30). These were submitted to English Heritage and the County Archaeological Officers (or their equivalents) in two groups, during January and February 1994. The WSIs set the parameters within which each evaluation would take place. These included recording strategies, the sample basis, and the number and location of trial-trenches. It was accepted, however, that the detailed methodology for any given site might have to be adapted in the field to take account of physical obstacles, ground conditions, local accessibility, and more detailed geotechnical information which might become available (some geotechnical works and reports were ongoing during the preparation of the WSIs).
- 1.6 Ten WSIs were prepared. The first group covered:- Thorpe Fields; land north of Wickham Lane; Unigate Dairies (Petters Sports Field); and Yeoveney Lodge. A WSI was also prepared for possible evaluation work at Runnymede Bridge; however, in the light of the engineering design and in consultation with English Heritage and the County Archaeologist for Surrey, it was agreed that sufficient was known from previous investigations for the purposes of the Environmental Assessment. The second group covered:- land west of the Thorpe Bypass; land between Longside Lake and Great Fosters; Queensmead Lake; the Cambridge Kennels; and Poyle Meadows. The WSIs were approved before fieldwork commenced. The County Archaeological Officers (or their equivalents) and English Heritage were kept informed of the progress and results of the evaluations throughout, and were offered the opportunity to visit the sites while fieldwork was in progress. Unfortunately other commitments precluded such visits.
- 1.7 The evaluations were undertaken in two stages. Thorpe Fields, the land north of Wickham Lane and the Unigate Dairies (Petters Sports Field) sites were evaluated between 31 January and 11 February 1994. The remaining sites were evaluated between 21 February and 4 March 1994. The field team consisted of up to five technicians, supervised by Chris Bell. All finds

processing and analysis was undertaken at the Oxford offices of the Oxford Archaeological Unit. Pottery and flint artefacts were assessed by Alistair Barclay and Philippa Bradley respectively. The assessment of the environmental samples from the Cambridge Kennels site was undertaken by Dr Mark Robinson at the Environmental Archaeology Laboratory, University Museum, University of Oxford. Maisie Taylor of the Fenland Archaeological Trust examined the wood from the Cambridge Kennels site. The project was managed by Graham Keevill.

- 1.8 Unless otherwise stated in the individual site reports, topsoil and other non-archaeological deposits in trenches were excavated down to the top of archaeological features, or in their absence to the top of the natural subsoil, using a JCB mechanical excavator with a toothless ditching bucket. Trench surfaces were then cleaned and recorded in plan and section. Archaeological features were excavated as appropriate. Trench plans were drawn at a scale of 1:100, with sections and plans of individual features drawn in more detail where necessary. Contexts were also fully described, and a representative photographic record was also made.
- 1.9 Trenches and test-pits were numbered individually site-by-site. The numbers were chosen so as to avoid any duplication of trench numbers between sites. Soils and archaeological deposits were then assigned context numbers within each trench. The trench number acts as a prefix for the context number; 26/1, therefore, represents context 1 in trench 26.
- 1.10 Each individual evaluation was assigned a site code for reference purposes. The first two digits of each code are taken from the parish containing the site: RU for Runnymede, Surrey; SP for Spelthorne, Surrey; and WR for Wraysbury, Berkshire. Yeoveney Lodge straddles the county boundary between Surrey and Berkshire and thereby lies within two parishes. The SP site code prefix was used because most of the planned trenches were within Surrey. The remaining digits refer to a more localised identifiable feature or name. The individual site reports presented here also include details of associated population centres where relevant (eg Thorpe and Egham).

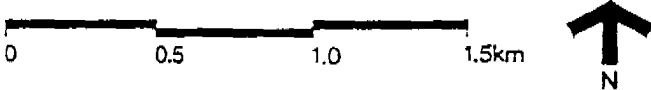
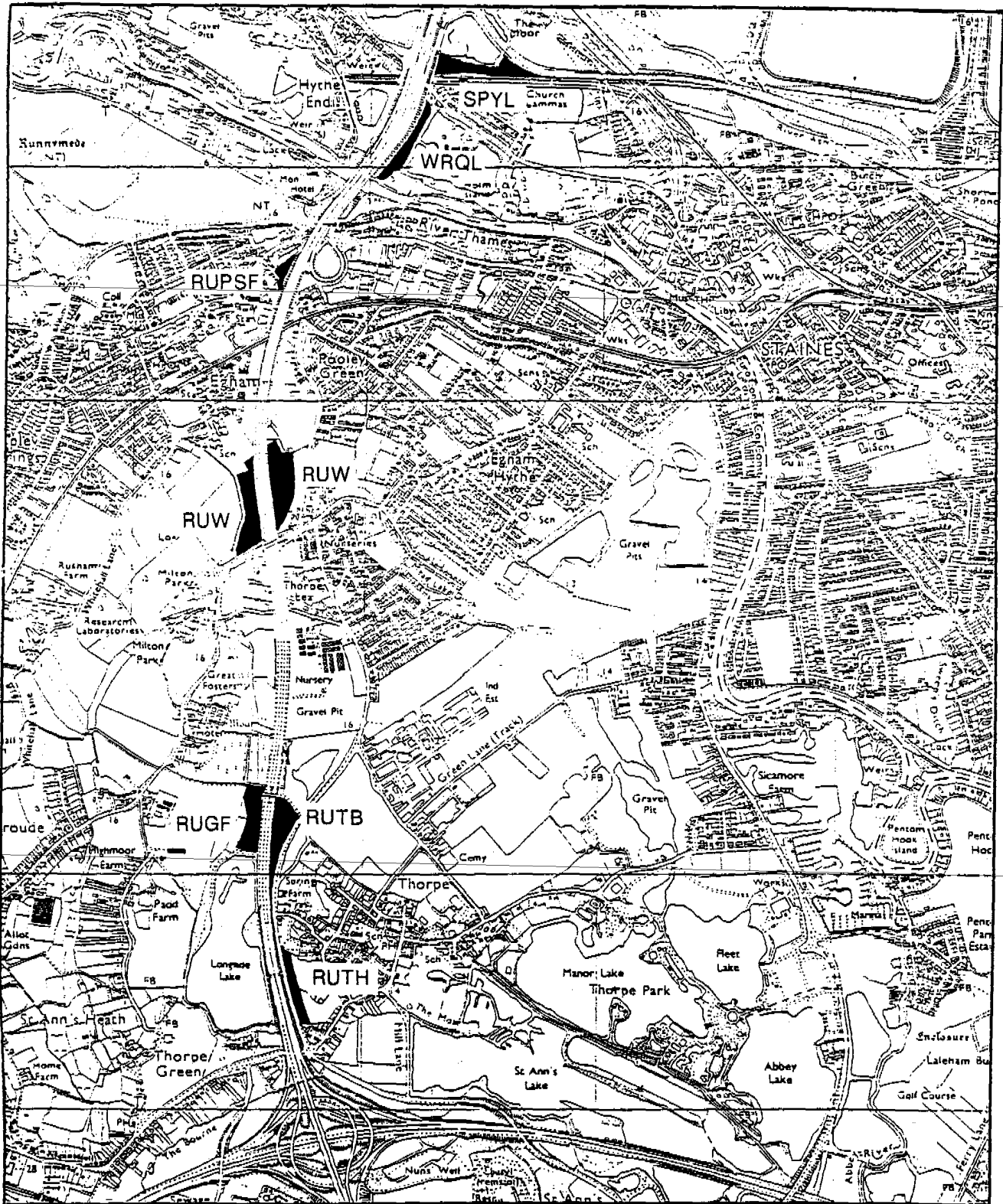

- Areas evaluated
- SPYL - Yeoveney Lodge
- WRQL - Queensmead Lake
- RUPSF - Unigate Dairies (Petters Sports Field)
- RUW - Land North of Wickham Lane
- RUTB - Thorpe Bypass
- RUGF - Great Fosters
- RUTH - Thorpe Fields

General location of the evaluation sites

Figure 1

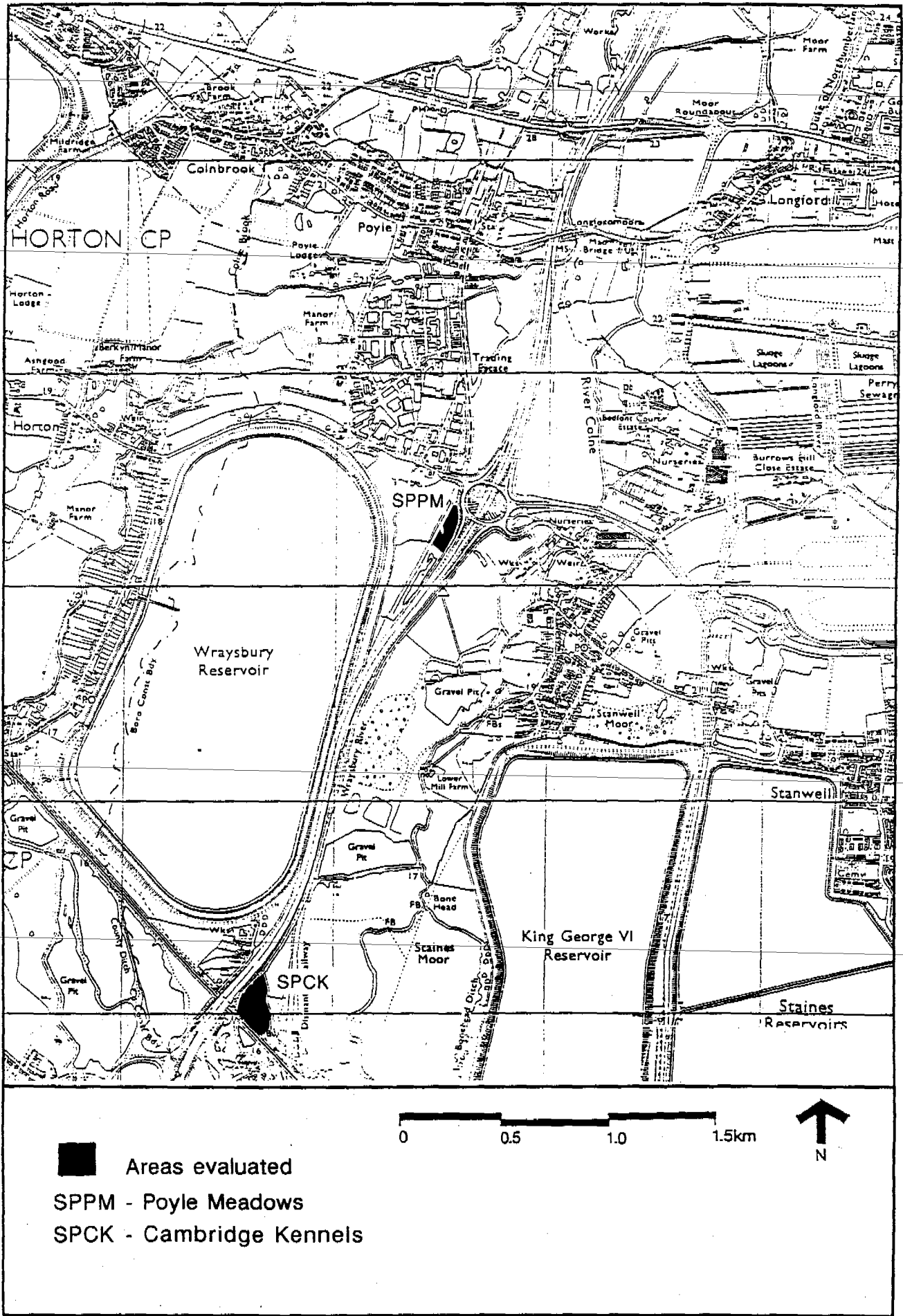

General location of the evaluation sites

Figure 2

2.0 THORPE FIELDS

2.1 Fieldwork took place at Thorpe Fields, Thorpe, Surrey (Figure 3; NGR TQ 017685, site code RUTH) over a period of three days, 9-11 February 1994. It was also intended to establish the possible continuation of a ditch complex seen during construction of the M25, and if possible to determine the date and character of the ditches. It had been intended to excavate two trenches in a separate plot of land immediately north of the Thorpe Field. Access permission was not forthcoming, however, and these trenches could not be excavated.

2.2 ARCHAEOLOGICAL BACKGROUND

2.2.1 Bronze age activity in the form of a ring ditch, pottery and bone were located during gravel extraction at Muckhatch Farm, in the area to the west of Thorpe Fields. A ditch complex was located during M25 construction. Hearths, burnt flint and pits were found with some bronze age pottery during the construction of the Thorpe Bypass. The Thorpe Fields site was therefore identified as an area of high archaeological potential, especially for the late bronze age.

2.3 TOPOGRAPHY AND GROUND CONDITIONS

2.3.1 A field boundary divides the site roughly in half, with the area to the south of the boundary being lower lying. The underlying geology in the south half of the site is clay silt, changing to sand and gravel in the north half of the area. The area of investigation is a recreation ground with a small copse at the north end.

2.3.2 Much of the site is low-lying. A prolonged period of wet weather immediately before fieldwork took place had saturated the ground. The three trenches in the south half of the field were badly affected by flooding.

2.4 STRATEGY

2.4.1 Five trenches 30 m in length x 1.6 m wide and two 15 m long x 1.6 m wide were excavated (Figure 3). This constituted a 2 % sample of the evaluation area. The position and length of trench 25 was dictated by the existence of trees, as this was the only clear area within a copse

at the north end of the site. As the trench was limited to 15 m in length, a second 15 m trench (trench 26) was excavated in the area between trenches 23 and 24. The trenches were numbered in sequence, from 20 to 26.

2.5 RESULTS

2.5.1 Trenches 20 to 22

2.5.1.1 The top of the natural silt was reached at an average depth of 0.5-0.6 m below the present ground surfaced. No archaeological features were observed in any of these trenches. A single flint flake was found in a layer of buried soil stratified between the natural silt and the topsoil in trench 20 (20/2). Two flint flakes and a piece of burnt flint were retrieved from the equivalent layer in trench 22 (22/2). These layers were generally well-sorted, with a minimal stone fraction; they may represent earlier ploughsoils. A deposit of bluish alluvium existed above the natural silt in the southern third of trench 20.

2.5.2 Trenches 23 to 26

2.5.2.1 The average depth of overburden removed to reveal archaeological features or the top of the natural sand was 0.5 m. The only archaeological feature located in these trenches was a north-west to south-east aligned ditch in trench 23 (Figure 4). The ditch (23/6) was some 0.6 m wide and 0.4 m deep. It contained two flint flakes, six pieces of burnt flint and three small fragments of prehistoric pottery. A flint flake was also retrieved from a layer of buried soil (23/2) which overlaid the ditch. The only other finds to come from this area were a few small fragments of tile from trenches 24 and 25.

2.6 ARTEFACTS RETRIEVED

2.6.1 Flint

2.6.1.1 A small assemblage of six pieces of struck flint and seven pieces of burnt unworked flint was recovered from the evaluations. No diagnostic retouched pieces were recovered, so that the date of the material is difficult to determine. The flint is a mid brown colour with some

lighter mottles. The cortex is thin and abraded, and ranges in colour from white to buff. This material may be available locally in river gravels.

Context	Typology
20/2	1 plunging flake
22/2	2 flakes, 1 burnt unworked flint
23/2	1 flake
23/3	2 flakes, 6 burnt unworked flints

Table 1: Thorpe Fields, flint typology

2.6.1.2 Both hard and soft hammers were used. A flake from 23/3 is very small and squat. All the burnt flint is heavily calcined. It is very difficult to date such a small assemblage, but the use of soft-hammers and the parallel blade scars on flakes from 20/2 and 22/2 may suggest a mesolithic or earlier neolithic date. Burnt unworked flint is often found on bronze age sites.

2.6.2 Pottery

2.6.2.1 Context 23/5 contained three small sherds of pottery, weighing a total of 3.0 g. Two sherds refit along a fresh break. All three sherds are in a worn condition. There are two fabrics: calcined flint, and sand and quartzite. It is difficult to date such small sherds. They are probably late bronze age in date, although they could be earlier.

2.7 DISCUSSION

2.7.1 The water table was very high at the time of the evaluation and the three trenches in the south half of the site partially flooded soon after excavation. The absence of archaeological features in this area meant that this did not affect the results.

2.7.2 The evaluation revealed a low level of archaeology. A single ditch was found, although

subsoil layers containing artefacts were also found in the south half of the site. It should be noted nevertheless that the ditch contained enough finds to suggest the presence of more extensive archaeology in the vicinity. The hearth of burnt flints and pits found in the vicinity of TQ 017686 during construction of the Thorpe Bypass, however, were not reflected in the evaluation. It seems likely that the bronze age sites in the area are small and discrete. It is possible that such sites could fall between trial-trenches. Typical sample patterns and levels, however, generally have a high statistical likelihood of locating such sites.

Context	Type	Width m	Depth m	Finds	Comments
20/1	Topsoil	-	0.30	-	Modern
20/2	Layer	-	0.18	1 flint flake	Buried ploughsoil?
20/3	Layer	-	0.20	-	Alluvium
20/4	Natural	-	-	-	Silt
20/5	Layer	-	0.16	-	Disturbed natural?
21/1	Topsoil	-	0.30	-	Modern
21/2	Layer	-	0.16	-	Buried ploughsoil?
21/3	Natural	-	-	-	Clay silt
22/1	Topsoil	-	0.28	-	Modern
22/2	Layer	-	0.24	2 flint flakes 1 piece of burnt flint	Buried ploughsoil?
22/3	Natural	-	-	-	Clay silt
22/4	Disturbance	0.70	0.52	-	Modern
22/5	Layer	-	0.52	-	Fill of 22/5
23/1	Topsoil	-	0.30	-	Modern
23/2	Layer	-	0.18	1 flint flake	Buried ploughsoil?
23/3	Ditch fill	-	0.36	2 flint flakes 6 pieces of burnt flint	Upper fill of 23/6
23/4	Ditch fill	-	0.12	-	Middle fill of 23/6
23/5	Ditch fill	-	0.10	2 fragments of prehistoric pottery	Lower fill of 23/6
23/6	Ditch	0.70	0.56	-	NW-SE, irregular U profile
24/1	Topsoil	-	0.20	-	Modern
24/2	Layer	-	0.20	1 piece of tile	Buried ploughsoil
24/3	Layer	-	0.08	-	Old ground surface?
24/4	Natural	-	-	-	Clay sand
24/5	Natural	-	-	-	Sandy silt
25/1	Topsoil	-	0.20	-	Modern
25/2	Layer	-	0.25	2 pieces of tile	Buried ploughsoil
25/3	Natural	-	-	-	Sandy silt
26/1	Topsoil	-	0.25	-	Modern
26/2	Layer	-	0.15	-	Buried ploughsoil?
26/3	Natural	-	-	-	Sand

Table 2: Thorpe Fields, context details

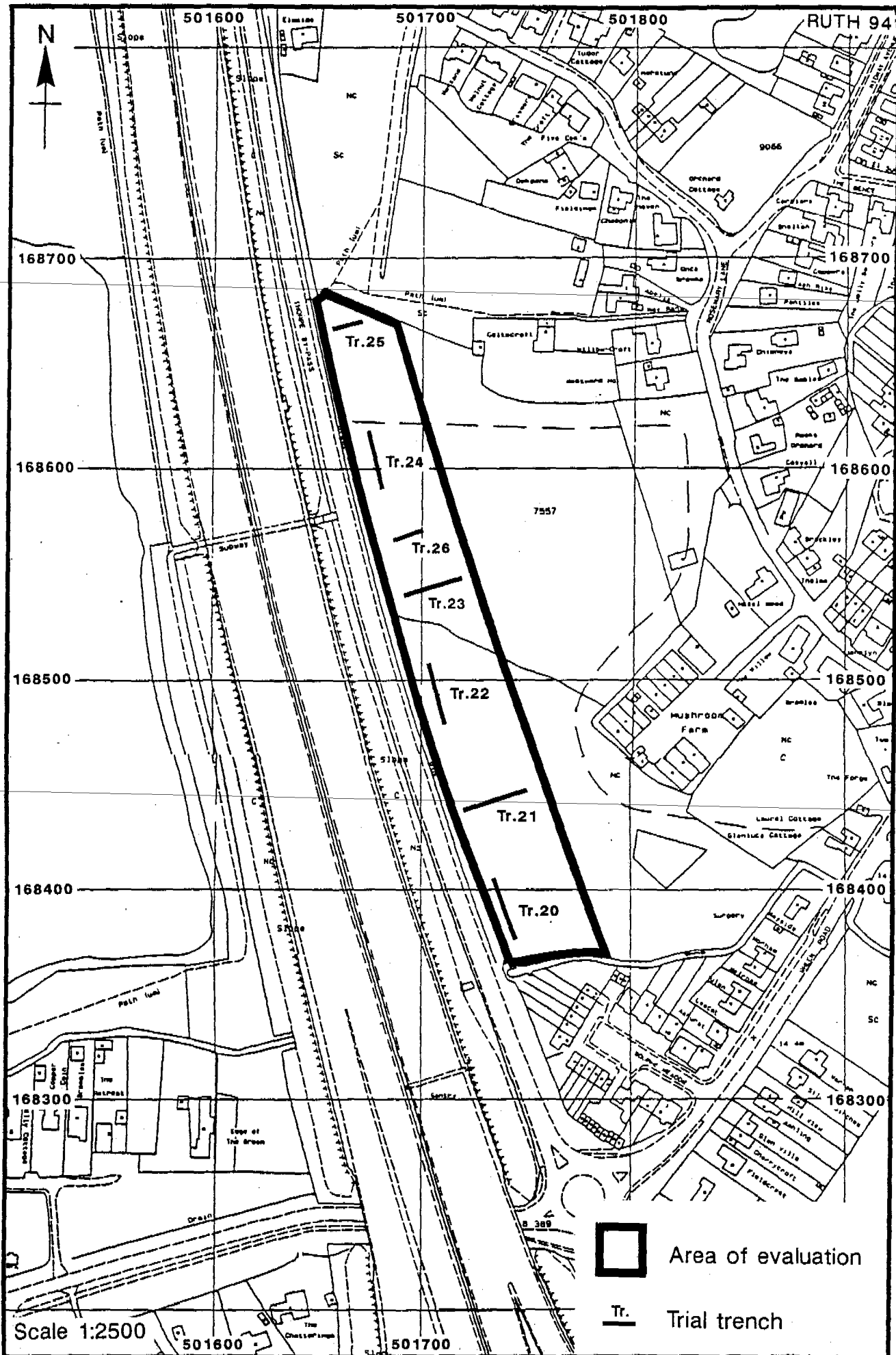

Thorpe Fields, trench locations

Figure 3

Trench 23

RUTH 94

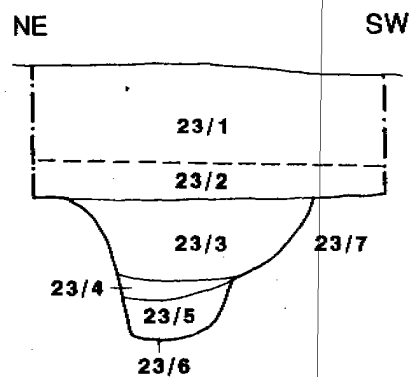
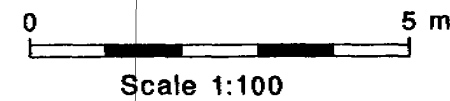
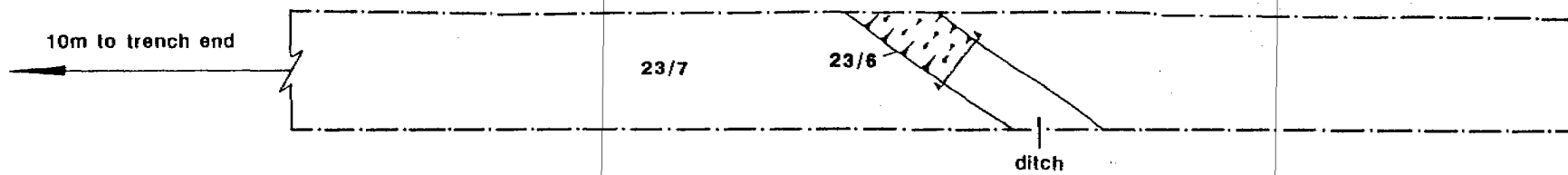

Thorpe Fields, plan and section, Trench 23

Figure 4

3.0 LAND WEST OF THORPE BYPASS

3.1 Fieldwork took place on land west of the Thorpe Bypass, Thorpe, Runnymede, Surrey (Figure 5; NGR TQ 016691, site code RUTB) on 1 March 1994. Access for a mechanical excavator was not possible, so two test-pits were dug by hand. The aim of the evaluation was to determine whether mineral extraction had occurred on the site.

3.2 ARCHAEOLOGICAL BACKGROUND

3.2.1 Bronze age activity in the form of a ring ditch, pottery and bone were located during gravel extraction at Muckhatch Farm which resulted in the creation of Longside Lake. Hearths, burnt flint and pits were located with some bronze age pottery during the construction of the Thorpe Bypass, and several sites and finds of prehistoric and Roman date were located between Muckhatch Farm and Hall Aggregates' gravel pit during the M25 construction and in advance of subsequent gravel extraction.

3.3 TOPOGRAPHY AND GROUND CONDITIONS

3.3.1 The area in question is a broadly triangular strip of flat land immediately to the north-west of Thorpe village between the Thorpe Bypass and the M25. A group of ponds and a lake to the north show that the area has been subjected to gravel extraction in the past. There was considerable uncertainty as to whether all or part of the area of investigation had also been quarried. Information from Redland Aggregates suggested that the area had been extracted in recent times, and that the site had subsequently been used as a contractor's compound during roadworks on the M25. At the time of excavation, the land was saturated, with standing water on the surface of the field in places.

3.4 STRATEGY

3.4.1 Two test-pits 0.9 m long x 0.7 m wide were excavated by hand to a depth of 0.5 m (Figure 5). They were then described and photographed.

3.5 RESULTS

3.5.1 The two hand-dug test-pits were located in the north half of the site, some 40 m apart. Modern backfill of clay, brick and rubble was discovered immediately below the topsoil in both of the test-pits. The backfill was observed to a depth of 0.5 m below the present ground surface, and though it clearly continued down below this level deeper excavation by hand became impractical. The same clay deposit, however, was visible over much of the field where, for instance, horseshoe marks had penetrated the grass cover.

3.6 DISCUSSION

3.6.1 The results from the test-pits confirmed that the area of investigation has been subjected to gravel extraction. Although the pits only represent a very small sample of the area, there were no topographical or vegetational changes to indicate that any other part of the site is unaffected. The limited depth achieved by hand excavation means that the results are not absolutely conclusive. The backfill could be due to dumping or landscaping. This remains unlikely, however, especially as it has been established that the land on the opposite side of the motorway between Longside Lake and Great Fosters has also been quarried (see sections 4.5 and 4.6).

Context	Type	Depth m	Comments
60/1	Topsoil	0.15	Modern
60/2	Layer	0.35	Modern
61/1	Topsoil	0.15	Modern
61/2	Layer	0.35	Modern

Table 3: Land west of Thorpe Bypass, context details

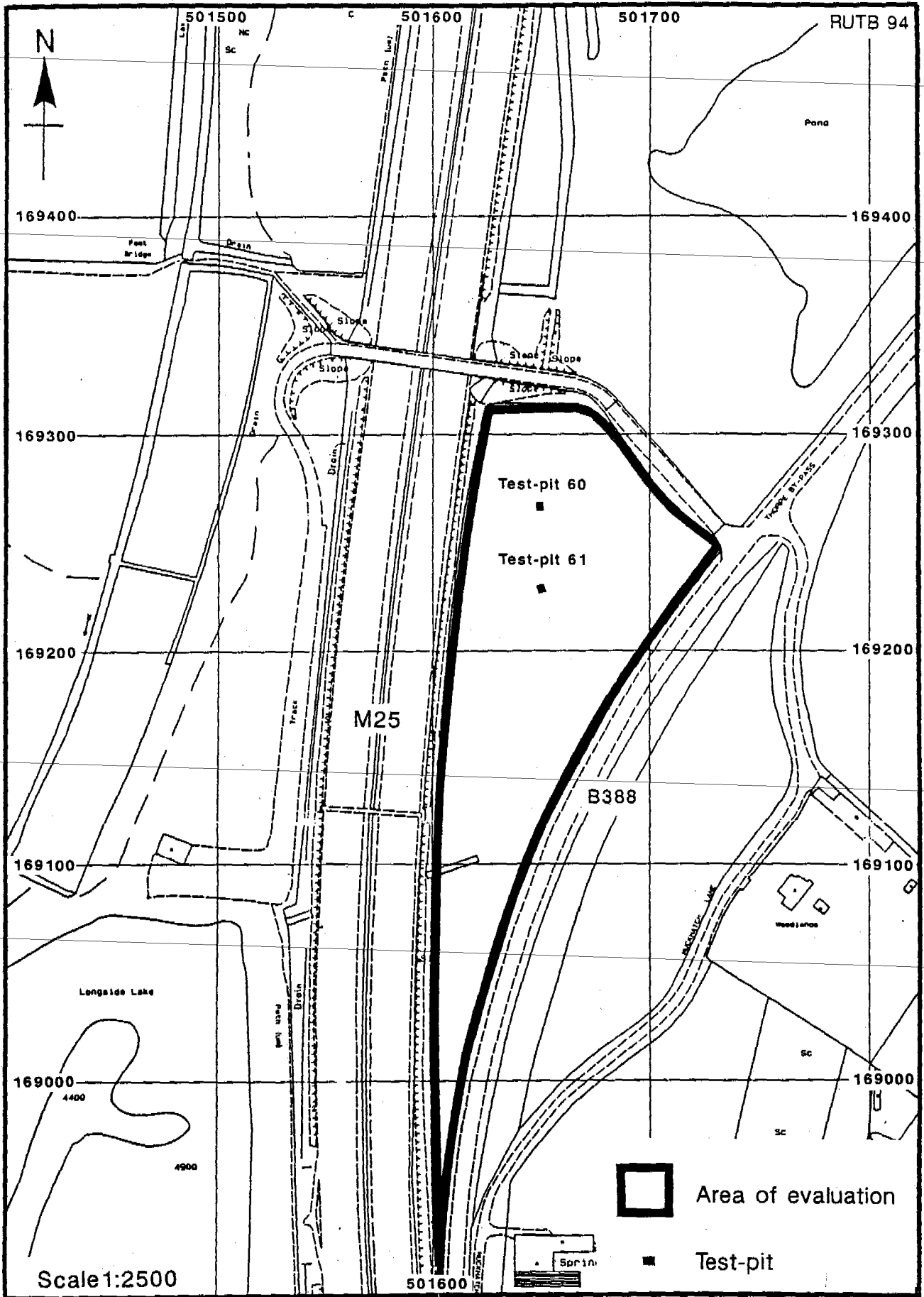

Land west of Thorpe Bypass, trench locations

Figure 5

4.0 LAND BETWEEN LONGSIDE LAKE AND GREAT FOSTERS

4.1 Fieldwork took place on land between Longside Lake and Great Fosters, Thorpe, Runnymede, Surrey (Figure 6; NGR TQ 015692, site code RUGF) on 1 March 1994.

4.2 ARCHAEOLOGICAL BACKGROUND

4.2.1 Bronze age, iron age, Romano-British and post-medieval activity was recorded on a series of sites to the east of Great Fosters. Various features, pottery, bones and other artefacts were excavated. More recent work by Surrey County Council on the east side of the M25 opposite Great Fosters has revealed significant bronze age, iron age and Romano-British occupation at the Hall Aggregates gravel pit. Further bronze age activity in the form of a ring ditch, pottery, and bone was located during gravel extraction at Muckhatch which resulted in the creation of Longside Lake.

4.3 TOPOGRAPHY AND GROUND CONDITIONS

4.3.1 The area in question lies immediately to the west of the M25 and to the north of Longside Lake. The area is presently wasteland, with a plantation of tree saplings at the northern end of the site. Some landscaping, presumably carried out during the construction of the M25, has clearly taken place. It was unclear whether the gravel extraction which created Longside Lake extended into part or all of the area of investigation. Information from Redland Aggregates suggested that this area had been extracted for minerals at the same time as the quarrying of Longside Lake.

4.4 STRATEGY

4.4.1 It was proposed that five 30 m x 1.6 m trenches would be excavated if the land remained undisturbed, comprising a 2 % sample of the total area in question. If backfilled extraction was discovered, it was decided that only test-pits would be needed to establish the extent of the extraction. In the event four test-pits were excavated (Figure 6). The test-pits were excavated to a typical depth of 1.20 m, using a JCB mechanical excavator; test-pit 50 and the ends of trench 51 were further excavated, to a maximum depth of 1.7 m. The east edge of the site could not be examined, as it is an access track to Longside Lake. The trenches/test-

pits were numbered in sequence, from 50 to 52.

4.5 RESULTS

4.5.1 All of the test-pits contained the same sequence of modern clayey topsoil over a very similar clay backfill matrix. Both layers contained much modern rubble (for example concrete and cement blocks, bricks, and other ceramic building materials). Excavation in trench 50, at the south end of the site, revealed the backfill to be at least 1.2 m thick below topsoil (0.28 m in depth) and a redeposited gravel layer (0.2 m in depth).

4.6 DISCUSSION

4.6.1 Test-pitting in the northern quadrant of the site could not be achieved without causing considerable damage to the sapling plantation. There were no topographical or vegetational changes to suggest that the extraction did not continue into this area, and evaluation was not considered worthwhile. Examination of exposed areas of the soil confirmed that the same clay matrix mixed with modern rubble was present in the plantation.

4.6.2 The evaluation confirmed the evidence from Redland Aggregates that gravel extraction has taken place throughout the site. There is a slight possibility that archaeological deposits might survive on the periphery of the area.

Context	Type	Depth m	Comments
50/1	Topsoil	0.28	Modern
50/2	Layer	0.20	Modern gravel dump
50/3	Layer	>1.20	Modern backfill
51/1	Topsoil	0.30	Modern
51/2	Layer	>0.90	Modern backfill
52/1	Topsoil	0.20	Modern
52/2	Layer	>0.90	Modern backfill

Table 4: Land between Longside Lake and Great Fosters, context details

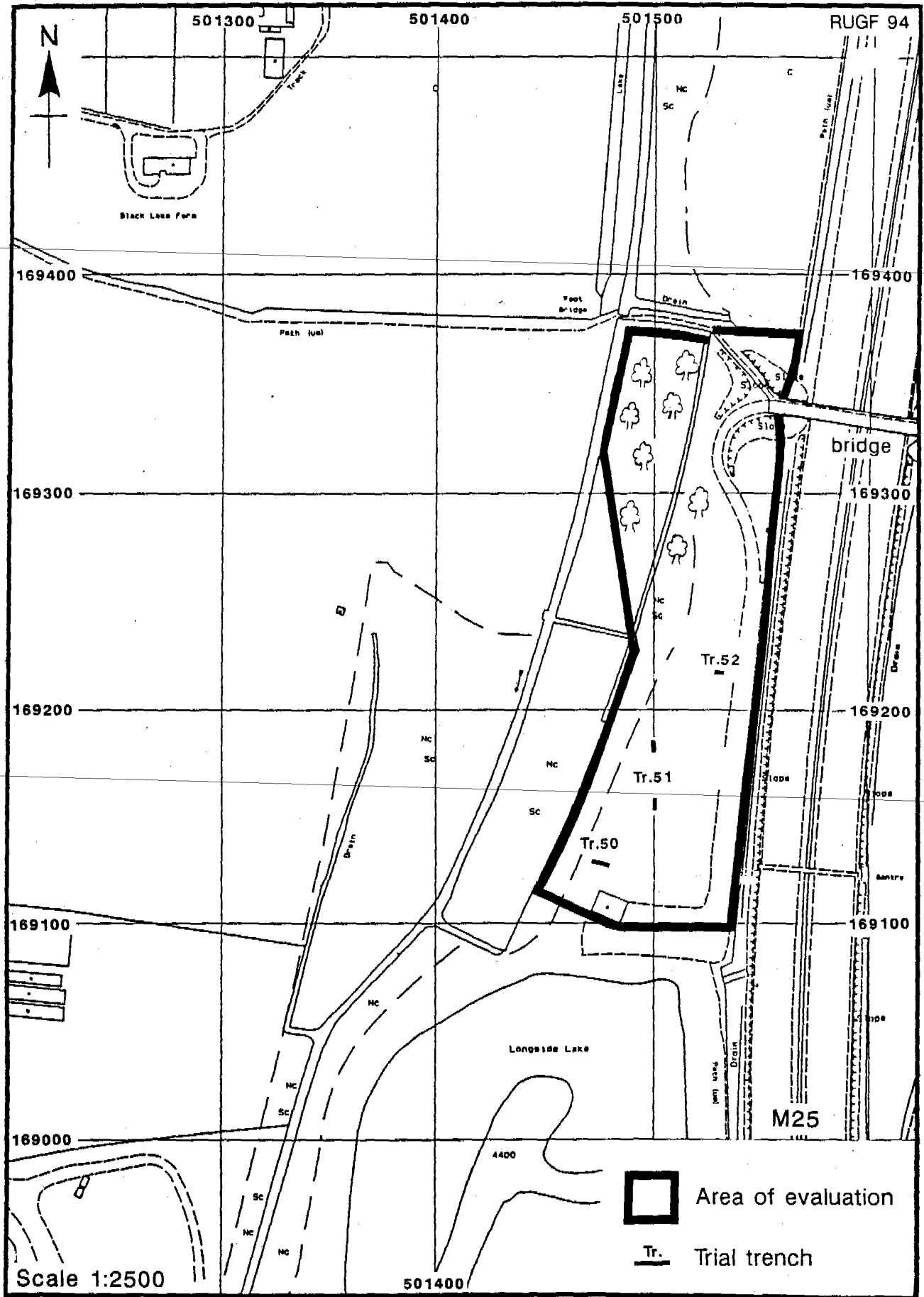

Land between Longside Lake and Great Fosters, trench locations

Figure 6

5.0 LAND NORTH OF WICKHAM LANE

5.1 It is proposed to construct two lakes on land immediately to the north of Wickham Lane, Egham, Runnymede, Surrey (Figure 7; NGR TQ 016706), one on either side of the motorway. These could have a major impact upon any archaeological deposits that might exist on the site. The aim of the evaluation was therefore to establish the presence and degree of preservation of any archaeological remains, and to determine their date range and character. Fieldwork (site code RUW) took place over a period of five days, from 31 January to 4 February 1994.

5.2 ARCHAEOLOGICAL BACKGROUND

5.2.1 The area immediately north of Wickham Lane only had one recorded site, at the north end of the area of investigation to the west of the motorway. A scatter of flint flakes and burnt flint was found here after topsoil stripping during the construction of the M25. The site, however, lies within an area of extensive prehistoric activity. The site was evaluated due to the large area of land take and the nature of the potential impact. A sample size of 1 % was selected, reflecting the low level of known archaeology.

5.3 TOPOGRAPHY AND GROUND CONDITIONS

5.3.1 The area of land take is c. 5.3 ha. The site consists of two fields on opposite sides of the motorway. Both fields are presently pasture land, but have been cultivated in recent times. The underlying geology is predominantly gravel.

5.3.2 Extensive rainfall in the period immediately preceding the fieldwork had left the ground saturated. Indeed the field on the west side of the motorway had been partially under water a week before the evaluation took place. The surface water had drained away by 31 January 1994 and excavation took place without hinderance. The deeper archaeological features did begin to fill with water after excavation, but this did not affect recording or interpretation.

5.4 STRATEGY

5.4.1 Twelve trenches were excavated (Figure 7). Five 30 m long x 1.6 m wide trenches and one 10 m long x 1.6 m wide trench were excavated in the field to the west of the motorway, while

six 30 m long x 1.6 m wide trenches were opened in the field to the east of the motorway. The trenches were numbered in sequence, from 1 to 12.

5.5 RESULTS

5.5.1 TRENCHES 1 TO 6 (WEST OF THE MOTORWAY)

5.5.1.1 The average depth of overburden removed to reveal archaeological features or the top of the natural gravel in this area was 0.55-0.7 m. Each of trenches 2, 3 and 6 contained two ditches. Both of the ditches in trench 2 were approximately 0.8 m wide x 0.4 m deep (Figure 8), and the furthest east, 2/6, produced two flint flakes. However, when the trench was slightly extended to reveal a complete cross section of the ditch two pieces of tile were found in the top fill. These may be intrusive (for example, introduced into the ditch fill by ploughing). A tree throw pit (2/10) containing large amounts of burnt flint was also located in this trench.

5.5.1.2 The two ditches in trench 3 lay towards the south end of the trench, some 2 m apart (Figure 9). The furthest south of the ditches, 3/7, was aligned east-north-east to west-south-west, and contained a single flint flake. Ditch 3/5, to the north, was aligned east-west and produced no finds.

5.5.1.3 Ditch 6/9, running through the centre of trench 6 (Figures 10 and 11), was the largest of the ditches. It was some 2.1 m wide and 0.95 m deep, was aligned east-west, and produced several flint flakes and a fragment of burnt flint. Ditch 6/6, at the south end of the trench (Figure 10), was also aligned east-west, and although only 0.1 m deep produced fragments of bone and a flint flake.

5.5.1.4 Trenches 1, 4 and 5 contained no archaeological features. Trenches 4 and 5, in the centre of the field, did contain a deposit of alluvium, and a piece of bone and a fragment of burnt flint were retrieved from the alluvium in trench 5. The alluvium also extended to the southern end of trench 6 (layer 6/5), where it overlay ditch 6/7.

5.5.2 TRENCHES 7 TO 12 (EAST OF THE MOTORWAY)

5.5.2.1 The average depth of overburden removed to reveal archaeological features or the top of the

natural gravel in this area was 0.35-0.5 m.

5.5.2.2 The only archaeological feature to be located in these trenches was a shallow pit in trench 11 (11/4), containing pieces of modern glass and slag. Deep modern disturbance was seen throughout trench 8, at the north end of the field, and a similar deposit to those filling the disturbance was also seen in the west end of trench 7 (layer 7/2).

5.6 ARTEFACTS RETRIEVED

5.6.1 Flint

5.6.1.1 A small assemblage of seven pieces of struck flint and 39 pieces of burnt unworked flint was recovered from the evaluation.

Context	Flake	Blade-like flake	Retouched	Burnt unworked	Total
2/5	1	-	1 serrated flake with gloss	-	2
2/11	-	-	-	36	36
3/6	1	-	-	-	1
4/4	-	-	-	1	1
5/6	-	-	-	1	1
6/7	1	-	-	-	1
6/8	1 (possibly from a polished implement)	2	-	1	4
Total	4	2	1	39	46

Table 5: Land north of Wickham Lane, flint typology

5.6.1.2 The flint generally has good flaking properties. The majority of the flint is mid brown in colour and is uncorticated. A blade-like flake from 6/8 exhibits medium cortication. Cortex

where present is thin and abraded and white or grey in colour. The cortex on one or two pieces is stained pinkish brown. There are two pieces of orange-brown flint (a flake from 2/5 with numerous cherty inclusions and a serrated flake also from this context). This material bears some similarity to the description of raw materials found at the causewayed enclosure at Staines (Healey and Robertson-Mackay 1983, 1). All of the flint seems to have come from small nodules, the exception being a blade-like flake of slightly better quality flint from context 6/8. Thus the majority of the flint may have come from local river gravels, although the blade-like flake from context 6/8 may have been brought in from slightly further afield.

5.6.1.3 None of the material is particularly diagnostic and is therefore difficult to date. The flakes, blade-like flakes and serrated flake have all been hard-hammer struck. A flake from fill 6/7 (ditch 6/6) and a blade-like flake from fill 6/8 (ditch 6/9) have been utilized. The latter has been struck from a core with at least two platforms. A flake from 6/8 has minute striations on its dorsal face and may be from a polished implement. It is a very small flake, however, and it is possible that the polishing is of natural origin.

5.6.1.4 The serrated flake would be consistent with a neolithic date. This example has silica gloss down its left-hand side and has been retouched along its right-hand side. The other flakes and blades may also be of this date although due to the size of the assemblage and the lack of diagnostic retouched pieces any dating must be regarded as tentative.

5.6.1.5 The concentration of burnt unworked flint in fill 2/11 (tree throw pit 2/10) is of interest. All of the flint has been heavily calcined or burnt; such deposits of burnt unworked flint are frequently associated with bronze age activity.

5.7 DISCUSSION

5.7.1 The water table was very high at the time of the evaluation, and some of the trenches in the area to the west of the motorway became partially flooded soon after excavation. This did not affect the overall interpretation because the stratigraphy was straightforward. The deep modern disturbance located on the east side of the motorway would appear to represent backfilled gravel extraction, perhaps associated with the construction of the M25. It was notable, however, that archaeological features were absent in trenches where the natural gravel had not been removed.

5.7.2 The evaluation established the presence of archaeology west of the M25. Six ditches were found, all apparently of prehistoric date. Four ditches were found at the south end of the site, while two were located at the extreme north end. A layer of alluvium in the centre and towards the north end of the area post-dated the southern ditch in trench 6. The distribution of the features suggests that two sites might be represented. Alternatively, the ditches could belong to a dispersed system of field boundaries and/or enclosures. In the latter instance, the different alignments of the ditches might suggest that more than one system was involved. Regardless of this, it is notable that the ditches mostly lie outside of the alluvial area. Presumably the slightly higher and more dry ground was deliberately chosen for activity.

5.7.3 Finds were restricted to worked and burnt flint. Two fragments of tile from the top fill (2/4) of ditch 2/3 may be intrusive. The flints suggest a date range in the neolithic and bronze ages, although the lack of strongly diagnostic artefacts must be noted. On the whole, however, the evaluation has confirmed the evidence recovered during the construction of the M25 for prehistoric activity on the west side of the motorway. The ditches in trench 6 seem especially likely to relate directly to the scatter of flint flakes and burnt flint found at TQ 01537078 (Johnson 1975, 25).

5.7.4 No archaeological features were found on the east side of the motorway. There was evidence for truncation of the natural gravel along the west edge of the area, ie immediately east of the M25. It is possible that this reflects activity associated with the motorway construction. It was notable, however, that archaeology was absent even where the gravel surface was undisturbed.

Context	Type	Width m	Depth m	Finds	Comments
1/1	Topsoil	-	0.24	-	Modern
1/2	Layer	-	0.26	-	Buried ploughsoil?
1/3	Natural	-	-	-	Silty clay
2/1	Topsoil	-	0.32	-	Modern
2/2	Layer	-	0.20	-	Buried ploughsoil?
2/3	Ditch	0.74	0.48	-	NE-SW, U-profile
2/4	Ditch fill	-	0.20	2 pieces of tile	Upper fill of 2/3
2/5	Ditch fill	-	0.30	2 flint flakes	Lower fill of 2/3
2/6	Ditch	0.84	0.40	-	N-S, U-profile
2/7	Ditch fill	-	0.08	-	Lower fill of 2/6
2/8	Ditch fill	-	0.22	-	Middle fill of 2/6
2/9	Ditch fill	-	0.18	-	Upper fill of 2/6
2/10	Tree throw pit	0.56	0.22	-	Contains burnt flint dump
2/11	Treehole fill	-	0.22	36 fragments of burnt flint	fill of 2/10
2/12	Natural	-	-	-	Clay
3/1	Topsoil	-	0.30	-	Modern
3/2	Layer	-	0.24	-	Buried ploughsoil?
3/3	Natural	-	-	-	Clay
3/4	Ditch fill	-	0.26	-	Fill of 3/5
3/5	Ditch	0.90	0.26	-	E-W, U profile
3/6	Ditch fill	-	0.22	1 flint flake	Fill of 3/7
3/7	Ditch	0.84	0.22	-	ENE-WNW aligned U-profile
4/1	Topsoil	-	0.22	-	Modern
4/2	Layer	-	0.15	-	Buried ploughsoil?
4/3		-	0.20	-	
4/4	Layer	-	0.25	-	Alluvium
4/5	Natural	-	-	-	Silty clay
5/1	Topsoil	-	0.26	-	Modern
5/2	Layer	-	0.15	-	Alluvium
5/3	Layer	-	0.14	1 piece of bone 1 piece of burnt flint	Alluvium
5/4	Natural	-	-	-	Clay silt
5/5	Tree throw pit	-	0.50	-	Not excavated
5/6	Treehole fill	-	-	-	Not excavated
6/1	Topsoil	-	0.20	-	Modern
6/2	Layer	-	0.26	-	Buried ploughsoil?

Context	Type	Width m	Depth m	Findings	Comments
6/3	Layer	-	0.14	-	
6/4	Natural	-	-	-	Clay
6/5	Layer	-	0.35	-	Alluvium
6/6	Ditch	0.80	0.10	-	E-W aligned
6/7	Ditch fill	-	0.10	5 pieces of animal bone + 1 flint flake	Fill of 6/6
6/8	Ditch fill	-	0.30	3 flint flakes 1 piece of burnt flint	Upper fill of 6/9
6/9	Ditch	2.00	0.95	-	E-W, U-profile
6/10	Ditch fill	-	0.24	-	Upper middle fill of 6/9
6/11	Ditch fill	-	0.23	-	Lower middle fill of 6/9
6/12	Ditch fill	-	0.12	-	Base fill of 6/9
7/1	Topsoil	-	0.40	-	Modern
7/2	Layer	-	0.20	-	
7/3	Layer	-	0.15	-	Buried ploughsoil
7/4	Natural	-	-	-	Gravel
8/1	Topsoil	-	0.24	-	Modern
8/2	Layer	-	1.30	-	Fill of modern disturbance
8/3	Layer	-	1/10	3 pieces post-med tile + 2 pieces of slag	Fill of modern disturbance
9/1	Topsoil	-	0.39	-	Modern
9/2	Layer	-	0.10	-	Redeposited gravel
9/3	Natural	-	-	-	Gravel and clay
10/1	Topsoil	-	0.30	-	Modern
10/2	Natural	-	-	-	Gravel
11/1	Topsoil	-	0.30	-	Modern
11/2	Layer	-	0.24	-	Buried ploughsoil?
11/3	Pit fill	-	0.40	1 piece of modern glass 1 piece of slag	Fill of 11/4
11/4	Pit	1.50	0.40	-	Modern
11/5	Natural	-	-	-	Gravel
12/1	Topsoil	-	0.27	-	Modern
12/2	Layer	-	0.21	-	Buried ploughsoil?
12/3	Natural	-	-	-	Gravel

Table 6: Land north of Wickham Lane, context details

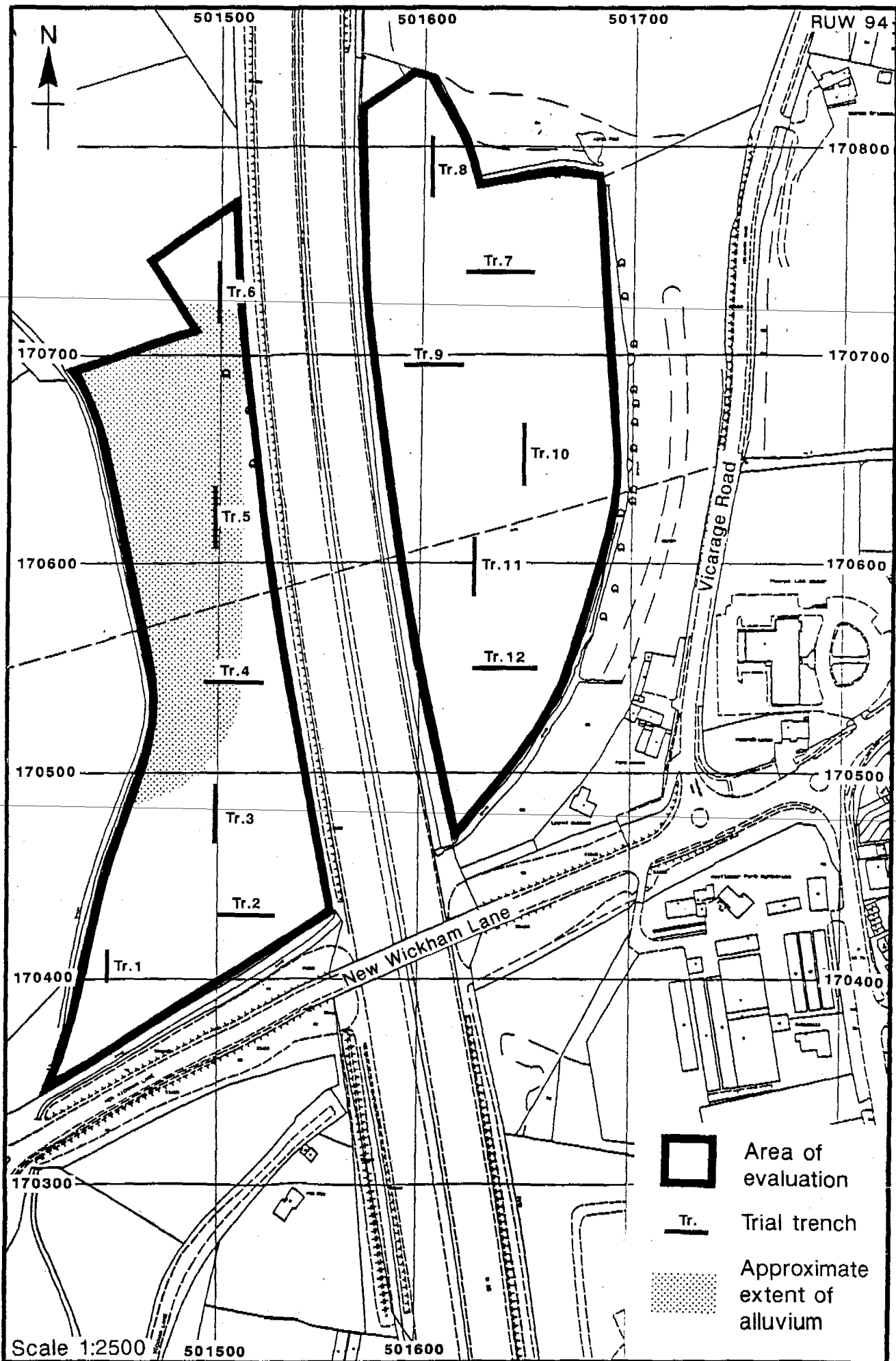

Land north of Wickham Lane, trench locations

Figure 7

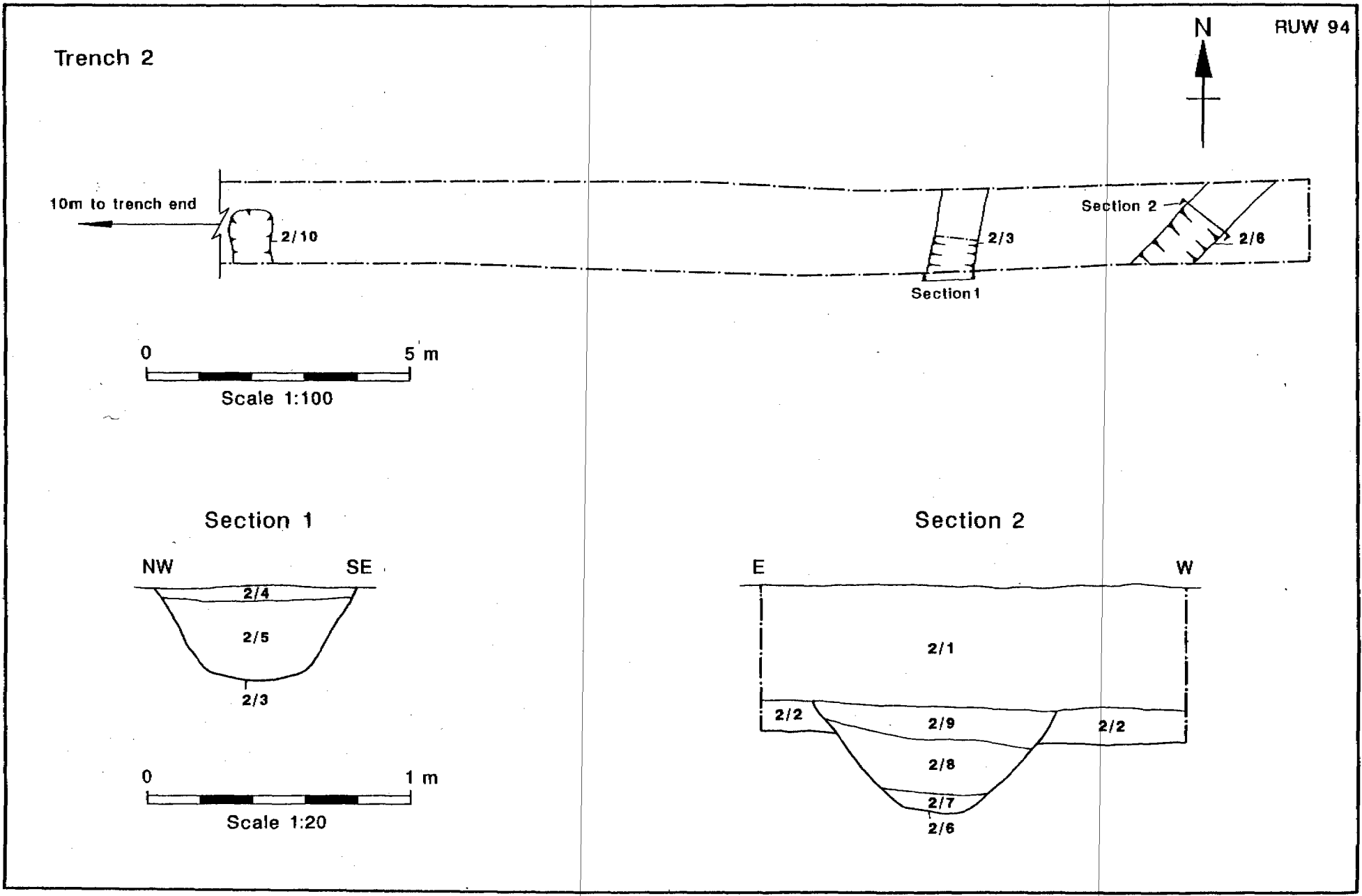

RUW 94



Land north of Wickham Lane, plan and sections, Trench 2

Figure 8

Trench 3

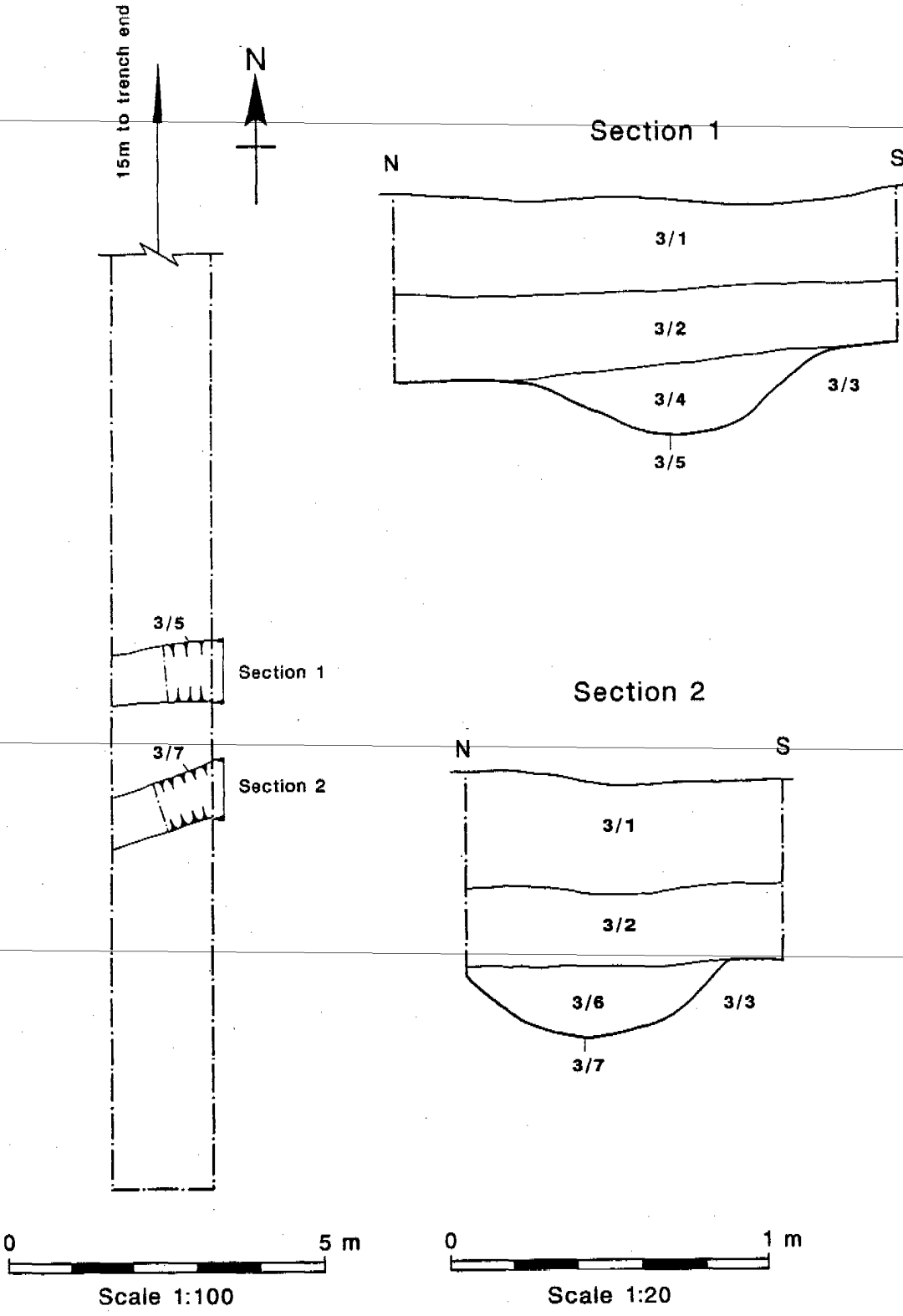

Land north of Wickham Lane, plan and sections, Trench 3

Figure 9

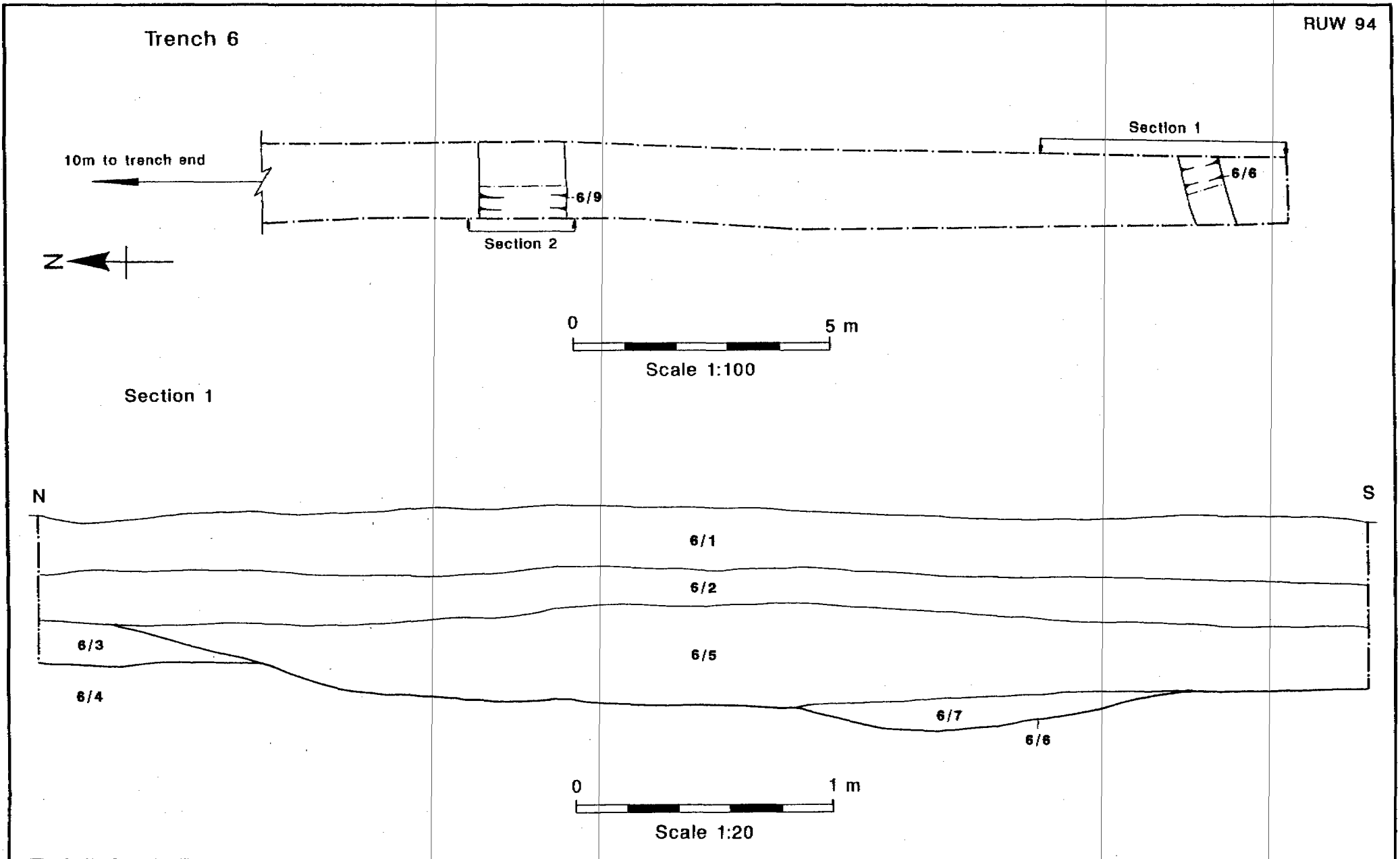

Land north of Wickham Lane, plan and section, Trench 6

Figure 10

Trench 6

Section 2

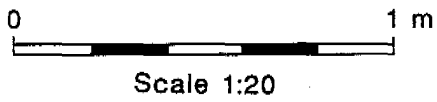
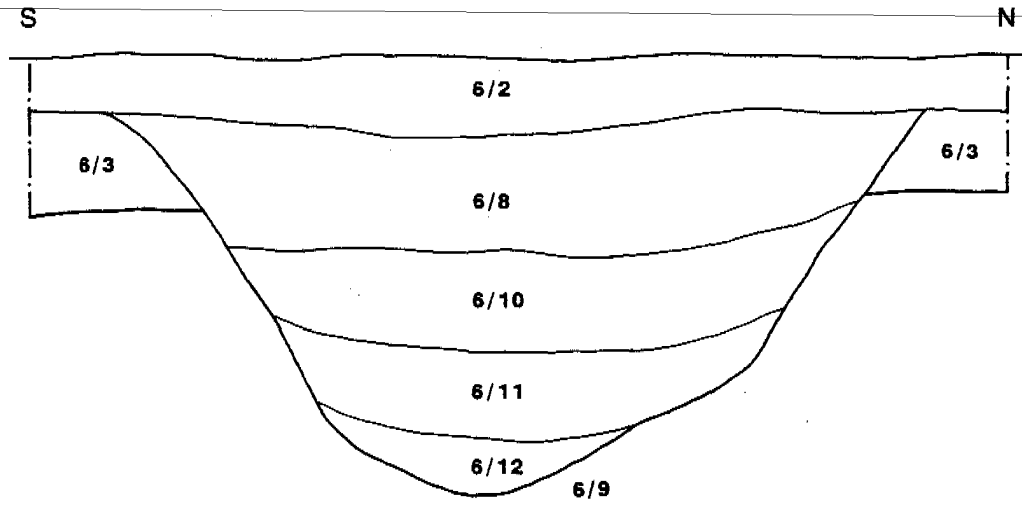

Land north of Wickham Lane, section of ditch 9, Trench 6

Figure 11

6.0 UNIGATE DAIRIES (PETTERS SPORTS FIELD)

6.1 Fieldwork took place at the Unigate Dairies (formerly Petters Sports Field), Egham, Runnymede, Surrey (Figure 12; NGR TQ 017716, site code RUPSF) over a period of two days, 7 and 8 February 1994.

6.2 ARCHAEOLOGICAL BACKGROUND

6.2.1 Trial-trenching in 1972 prior to the construction of the M25 located bronze age and Romano-British remains in the area of Petters Sports Field, Egham. The field was bisected by the motorway. There was evidence of early and middle bronze age activity, and more particularly an area of intense late bronze age occupation. This was notable for the finding of a stone mould for casting bronze axes (Johnson 1975, 12-14).

6.2.2 A substantial excavation was subsequently carried out immediately to the west of the motorway, in an area then thought to be threatened by development. The excavation revealed extensive remains from the neolithic to post-medieval periods. The most important phase of activity identified on the site occurred during the late bronze and early iron age and included a large ditch in which a hoard of bronzes had been deliberately deposited. Several hut circles and a number of pits which may have been contemporary with the hoard were also located (O'Connell 1986).

6.2.3 The evaluation was intended to establish whether remains relating to previously-excavated bronze age and Romano-British settlements extended into the area of investigation.

6.3 TOPOGRAPHY AND GROUND CONDITIONS

6.3.1 The underlying geology on the site is mostly gravel, changing to sand towards the south end of the site. The southern half of the evaluation area, investigated by trench 200, is presently overgrown wasteland. The northern part of the site, investigated by trench 100, has been used recently as a carpark. No trenches were excavated in the central area, as this part of the site was fully investigated in the 1970s. Small areas of unexcavated ground apparently survive in this area (O'Connell 1986, Figure 1), but little further information would be gained by trial-trenching at this stage.

6.4 STRATEGY

6.4.1 Two 30 m trenches, 1.6 m wide, were excavated down to the top of archaeological features, or in their absence to the top of the natural gravel (see Figure 12). The trenches were numbered 100 and 200.

6.4.2 The Written Scheme of Investigation had proposed that a trial-trench should be excavated on the east side of the M25 in order to determine whether the late major bronze age ditch which terminated in the earlier excavations continued eastwards (O'Connell 1986, 11-15 and Figure 8). It was impossible to gain access to the proposed trench location, however, because of the overgrown condition of the land, including semi-mature trees. Furthermore the proposed trench location contained a large topsoil dump. This trench, therefore, could not be excavated.

6.5 RESULTS

6.5.1 Trench 100 (north end of site)

6.5.1.1 Removal of the concrete and hardcore, which formed the carpark surface in this area, immediately revealed the natural gravel. The only archaeological feature located in this trench was a ditch (100/3) aligned north-east to south-west. A section was hand excavated through the ditch and a plastic bag was found within the fill. A second section was therefore excavated further to the north by machine, to determine whether the plastic was within an area of disturbance. The second section, however, contained a modern large steel nail.

6.5.2 Trench 200 (south end of site)

6.5.2.1 The top of the natural sand was reached at an average depth of 0.85 m below the present ground surface. A number of buried soil horizons were seen in section. Some of these were well-sorted, with minimal stone fractions, and were interpreted as old ploughsoils. No archaeological features were observed, however, and no finds were retrieved from any of the layers of overburden.

6.6 DISCUSSION

- 6.6.1 The concrete and hard core for the carpark surface in the area of trench 100 were laid down after truncation of the natural gravel. This truncation appears to have been severe. This is also indicated by the higher level of the undisturbed ground to the south.
- 6.6.2 The function of the recently infilled ditch found in trench 100 is unclear. It did not contain a pipe or cable, and would therefore not appear to be a service trench. It is conceivable that the feature is genuinely archaeological and has been excavated in the past. Johnson (1975, 12-14) briefly describes several ditches which were located and excavated during trial-trenching in 1972, but unfortunately there is no trench or feature location plan in the published report. The location of some of Johnson's trenches is shown in the Petters Sports Field monograph (O'Connell 1986, Figure 1), but it is difficult to establish the relationship between Johnson's description and O'Connell's plan. Certainly the latter does not show any trenches, either from 1972 or subsequently, in the same location as the 1994 excavation.
- 6.6.3 The absence of archaeological features in trench 200 suggests that the archaeological activity recorded in the 1970s does not extend significantly beyond the southern limit of those excavations. The north part of the site has been truncated in modern times during the laying of the carpark surface. Insubstantial archaeological features are likely to have been severely damaged or destroyed by this work. Deep features might still survive, but the degree of truncation will inevitably have reduced their potential information yield.

Context	Type	Width m	Depth m	Finds	Comments
100/1	Concrete	-	0.14	-	Carpark surface
100/2	Hardcore	-	0.16	-	Make-up for 100/1
100/3	Ditch	1.36	0.74	-	NE-SW, modern fill
100/4	Ditch fill	-	0.50	1 steel nail 1 plastic bag	Fill of 100/3
100/5	Ditch fill	-	0.32	-	Fill of 100/3
100/6	Natural	-	-	-	Gravel
200/1	Topsoil	-	0.22	-	Modern
200/2	Layer	-	0.16	-	-
200/3	Layer	-	0.19	-	Buried ploughsoil?
200/4	Layer	-	0.30	-	Buried soil
200/5	Layer	-	0.10	-	Buried soil
200/6	Layer	-	0.12	-	-
200/7	Natural	-	-	-	Clay sand
200/8	Layer	-	0.20	-	Buried soil
200/9	Layer	-	0.14	-	-
200/10	Layer	-	0.30	-	-

Table 7: Unigate Dairies (Petters Sports Field), context details

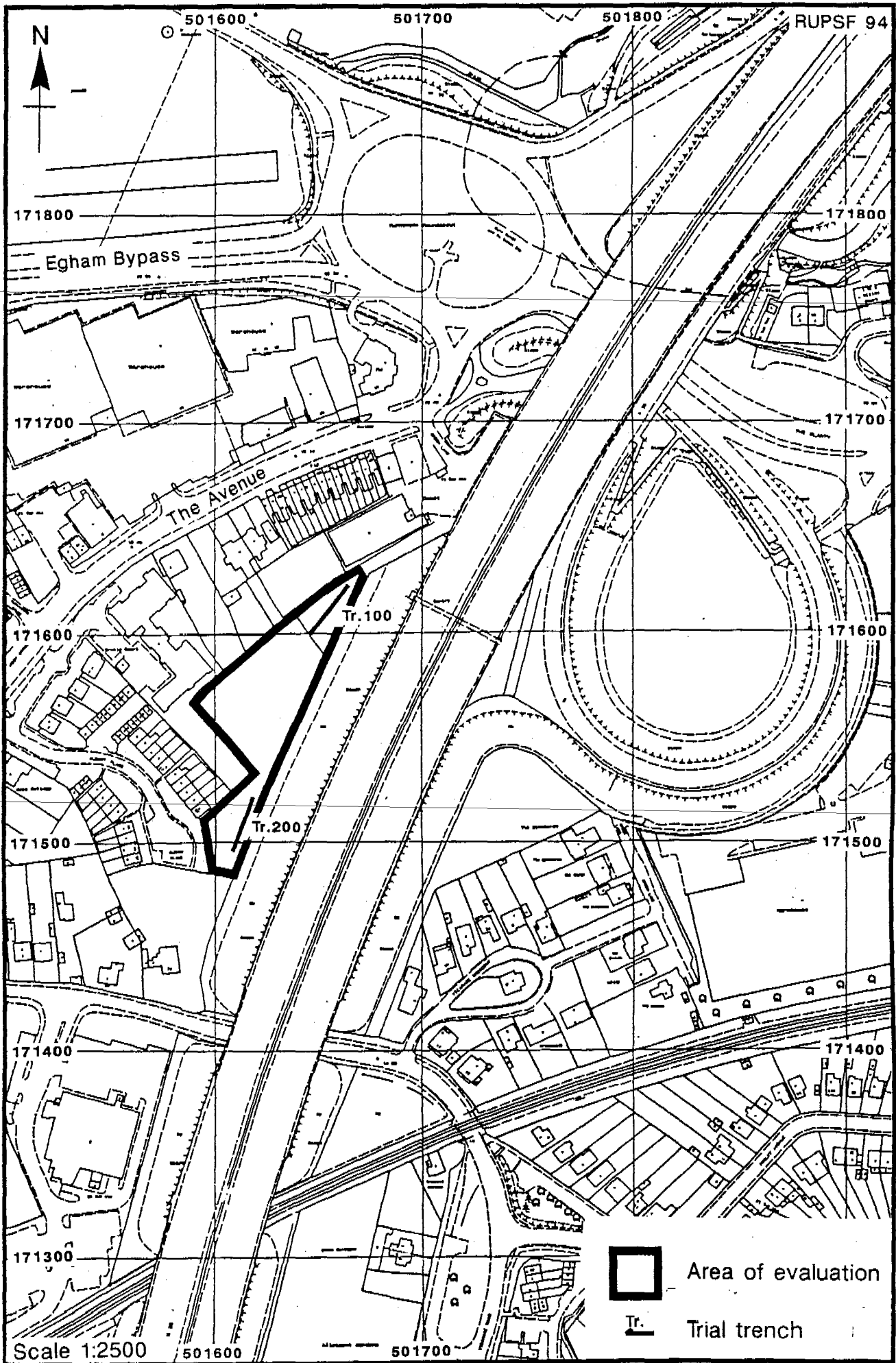

Unigate Dairies (Petters Sports Field), trench locations

Figure 12

Trench 100

RUPSF 94

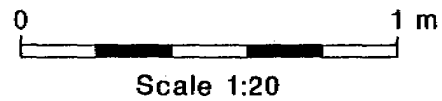
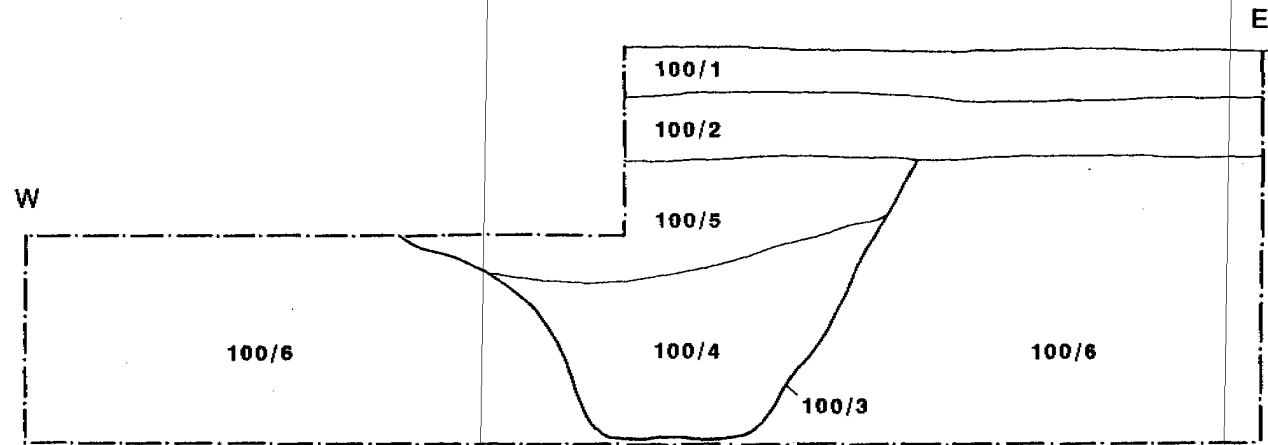
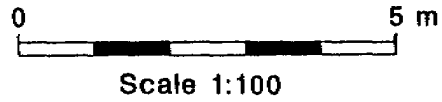
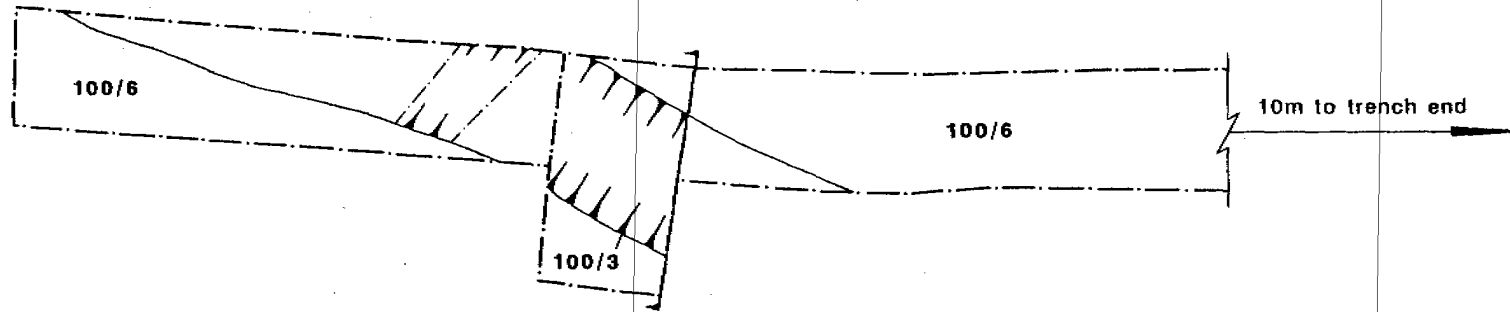
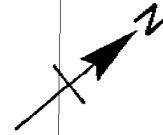

Unigate Dairies (Petters Sports Field), plan and section, Trench 100

Figure 13

7.0 LAND WEST OF QUEENSMEAD LAKE

7.1 Fieldwork took place on land to the west of Queensmead Lake, Wraybury, Berkshire (Figure 14; NGR TQ 220722, site code WRQL) over a period of one and a half days, 2-3 March 1994.

7.2 ARCHAEOLOGICAL BACKGROUND

7.2.1 Prehistoric pottery, and a possible pit associated with worked and burnt flints, were found during mineral extraction and construction of the reservoir. Other known archaeology in the vicinity includes the nationally important prehistoric site at Runnymede Bridge (including a late bronze age waterfront structure and associated settlement evidence), a bronze age enclosure at Church Lammas (TQ 02687213), a stone axe (TQ 02437232) and several finds from the Thames on the west side of Runnymede Bridge. The southern end of the area of the land take strip lies within an area shown as woodland on the first edition Ordnance Survey map.

7.3 TOPOGRAPHY AND GROUND CONDITIONS

7.3.1 The area of investigation is a heavily overgrown strip of mixed deciduous woodland between the Queensmead Lake reservoir and the M25. The underlying geology is gravel and the land is fairly flat.

7.4 STRATEGY

7.4.1 Five 1.6 m wide trenches of various lengths (dictated by the position of trees) were machine-excavated down to the top of the natural gravel (see Figure 14). The trenches were numbered in sequence, from 70 to 74.

7.5 RESULTS

7.5.1 In the two trenches excavated at the south end of the site (70 and 71) the top of the natural gravel was reached at a depth of 1.9 m below the present ground surface. This meant that for safety and reinstatement considerations only test-pits at either end of these trenches could be

excavated. In both trenches the natural gravel was overlaid by deep deposits of alluvium, above which were various deposits of modern dumping and in places deep modern disturbance (for example feature 4, Figure 15).

7.5.2 Trenches 72, 73 and 74, in the central and northern parts of the site, were excavated to lengths of 21.5 m, 8 m and 5 m respectively. The depth to the top of the natural gravel gradually shallowed out from 1.05 m at the south end of trench 72 to 0.55 m at the north end of trench 74. In all of these trenches the natural gravel was overlaid by deposits of alluvium, above which were modern dump layers. The only features located in these trenches were a few small tree throw pits, seen in the top of the natural gravel, in trenches 72 and 73. No archaeological features were observed in any of the five trenches, and no finds other than modern material were retrieved from any of the layers of overburden.

7.6 DISCUSSION

7.6.1 The limited areas free from major trees, and the depth of overburden at the south end of the site, meant that only some 55 m of trench could be excavated in total. This constitutes a sample of less than 1 % of the area of investigation. The failure of the evaluation to locate any archaeological features cannot therefore be seen as conclusive evidence for an absence of archaeology. Nevertheless the total absence of pre-modern features, pottery, flints, bone or other artefacts from any of the deposits excavated adds to the conclusion that the site is of low archaeological potential.

Context	Type	Width m	Depth m	Artefacts	Comments
70/1	Topsoil	-	0.15	-	Modern
70/2	Layer	-	0.55	-	Modern dumping
70/3	Layer	-	0.20	-	Buried soil (Modern)
70/4	Layer	-	0.30	-	Alluvium
70/5	Layer	-	0.60	-	Alluvium
70/6	Natural	-	-	-	Gravel
71/1	Topsoil	-	0.15	-	Modern
71/2	Layer	-	0.45	-	Buried soil
71/3	Layer	-	1.20	Concrete block	Modern backfill
71/4	Disturbance	0.70	1.20	-	Modern
71/5	Layer	-	0.34	-	Alluvium
71/6	Layer	-	0.46	-	Alluvium
71/7	Layer	-	0.50	-	Alluvium
71/8	Natural	-	-	-	Clay soil
72/1	Topsoil	-	0.13	-	Modern
72/2	Layer	-	0.20	-	Modern dumping
72/3	Layer	-	0.20	-	Modern
72/4	Layer	-	0.50	-	Alluvium
72/5	Natural	-	-	-	Gravel
72/6	Tree hole	-	-	-	Not excavated
72/7	Tree hole	-	-	-	Not excavated
73/1	Topsoil	-	0.22	-	Modern
73/2	Layer	-	0.18	-	Modern
73/3	Layer	-	0.17	-	Alluvium
73/4	Layer	-	0.11	-	Alluvium
73/5	Layer	-	0.20	-	Alluvium
73/6	Natural	-	-	-	Gravel
73/7	Tree hole	-	-	-	Not excavated
73/8	Tree hole	-	-	-	Not excavated
74/1	Topsoil	-	0.25	-	Modern
74/2	Layer	-	0.18	-	Modern
74/3	Layer	-	0.13	-	Buried soil
74/4	Layer	-	0.11	-	Alluvium
74/5	Natural	-	-	-	Sand
74/6	Natural	-	-	-	Gravel

Table 8: Land west of Queensmead Lake, context details

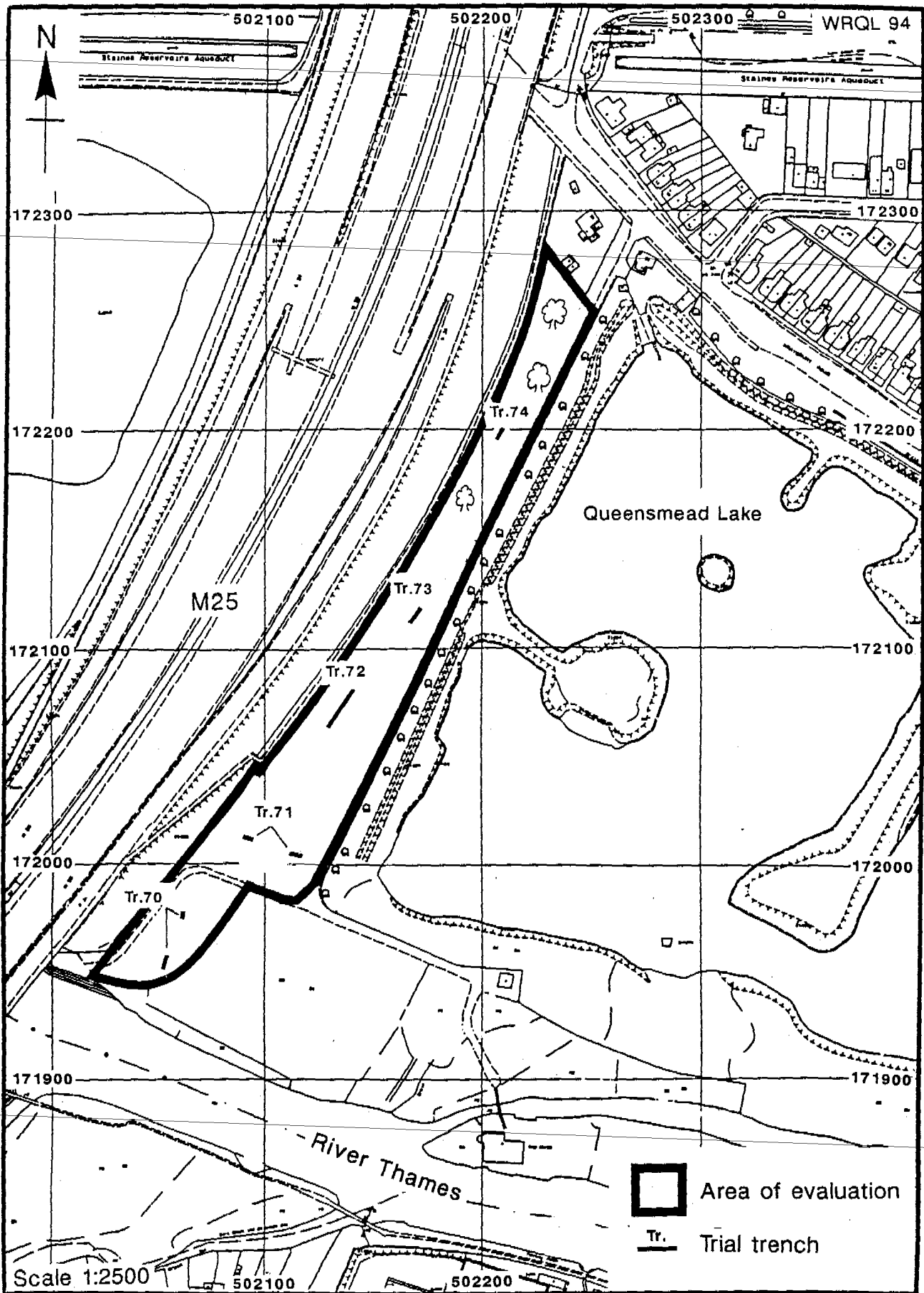

Land west of Queensmead Lake, trench locations

Figure 14

Trench 71

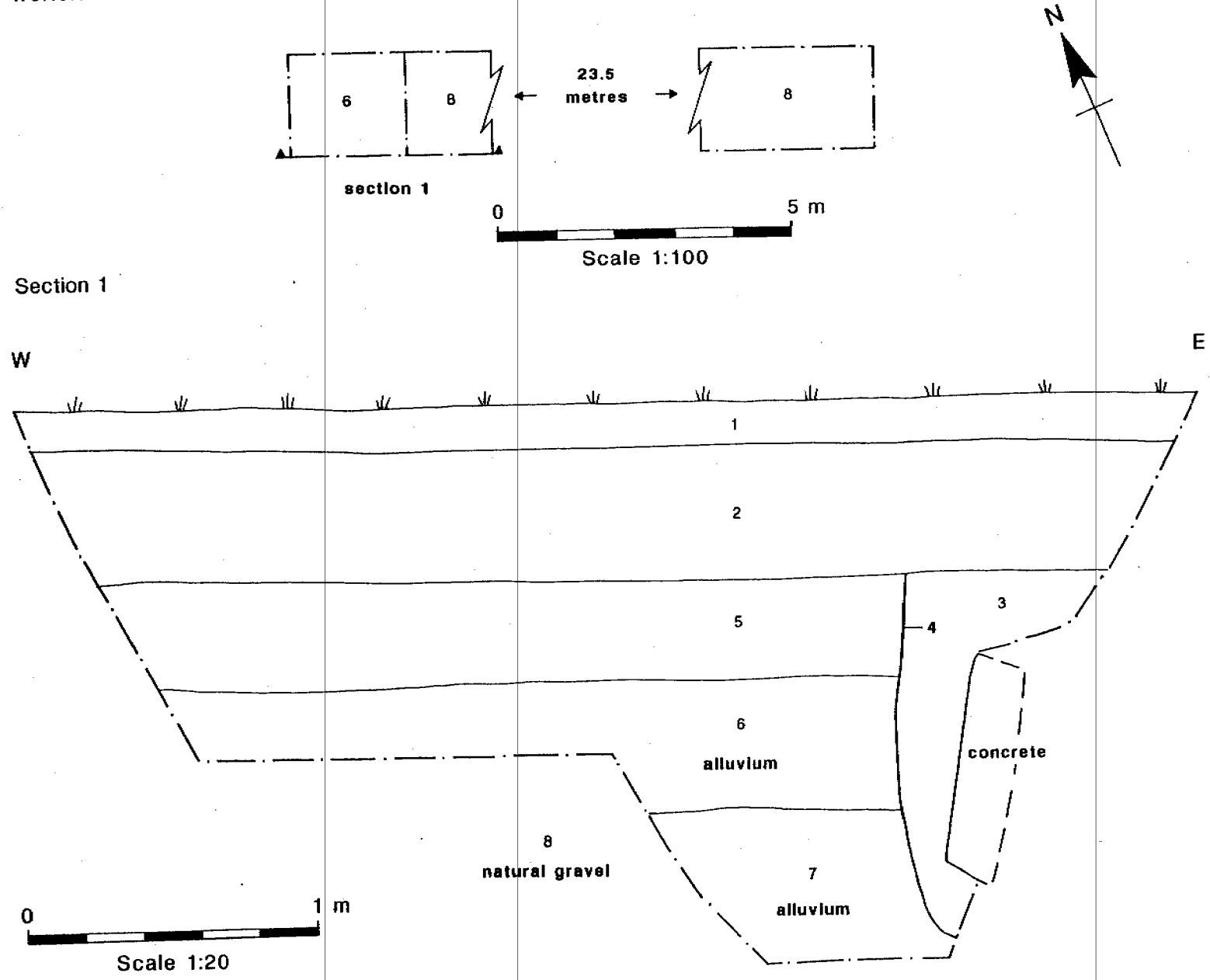

Figure 15

Land west of Queensmead Lake, plan and section, Trench 71

8.0 YEOVENEY LODGE

8.1 Fieldwork took place on land at Yeoveney Lodge, straddling the county boundary between Surrey (parish of Spelthorne) and Berkshire (parish of Wraysbury - Figure 16; NGR TQ 025724, site code SPYL) over a period of one and a half days, 3 and 4 March 1994. Construction work proposed for the site, including the remodelling of Junction 13, slip roads and associated landscaping, could have a substantial impact on any archaeological remains, especially at the west end of the area, where Junction 13 and associated access roads are to be remodelled. Landscaping elsewhere would have a lesser impact on any archaeology. The aim of the evaluation was therefore to establish the presence, degree of preservation and extent of any archaeological remains, so that possible mitigation strategies could be proposed. Of particular concern was the location of any activity contemporary with the Staines neolithic causewayed enclosure, previously excavated prior to mineral extraction, and to establish whether bronze age activity found at the causewayed enclosure and the Church Lammas site to the E, also extended into the area of investigation.

8.2 ARCHAEOLOGICAL BACKGROUND

8.2.1 An early to middle neolithic causewayed enclosure discovered by aerial photography south of Yeoveney Lodge in 1959 was excavated prior to gravel extraction in 1961-3 (Robertson-Mackay 1987). The enclosure, formed by two concentric interrupted ditches 20 m apart, covered an area of about 2.4 ha; most of this was destroyed by the extraction programme. Human burials were found within the interior of the enclosure, along with pits, gullies, post-and stakeholes. Various concentrations of neolithic pottery and struck and burnt flint were also found. Later prehistoric, Roman and medieval finds were also recovered.

8.2.2 Recent excavations by Surrey County Council revealed an unusual bronze age enclosure in Church Lammas field, about 500 m east of the causewayed enclosure. A rectangular enclosure approximately 25 m x 35 m contained a smaller, 10 m square enclosure. There was a possible burial pit inside the smaller enclosure (Hayman, 1991). Linear ditches on the same alignment as the main enclosure suggest that the site may have lain within a more extensive field system.

8.3 TOPOGRAPHY AND GROUND CONDITIONS

8.3.1 The area of investigation consists of a narrow, roughly triangular strip of land to the east of the M25, Junction 13. The Staines Bypass, which now runs to the north, originally ran through the middle of the site (Figure 16). Extensive disturbance and landscaping associated with the road and its later dismantling has clearly taken place. The line of the original road is still visible on the ground as a change in the vegetation. The field is presently pasture, but has been cultivated in recent times. The underlying geology is gravel. Mineral extraction has taken place over much of the surrounding area, but is not known to have extended into any part of the site.

8.4 STRATEGY

8.4.1 It was originally proposed to excavate seven trenches, 30 m in length x 1.6 m wide, comprising a 2 % sample of the area in question. If deep modern disturbance caused by the construction of the original Staines Bypass was identifiable, however, a more limited strategy of test-pitting would assess the extent of disturbance. Trenching would then be restricted to areas unaffected by the disturbance. In the event one 30 m trench and three 1.6 m-wide test-pits were excavated (Figure 16). Where deep modern disturbance was located, the general excavation depth was limited to 1.2 m for health and safety reasons, although deeper sondages were dug where necessary. The trench and test-pits were numbered in sequence, from 80 to 83.

8.5 RESULTS

8.5.1 Two test-pits were excavated on the line of the old A30 Staines bypass. Test-pit 80, in the northwest corner of the site, was excavated to a length (east-west) of 4.6 m and a depth of 0.6 m, at which point clean gravel was located. Machine excavation continued for a further depth of 0.6 m at the east end of the pit, establishing that the gravel was not redeposited. Coarse gravel and tarmac had been heavily compacted into the top of the gravel surface during the road construction. Above this level were layers of modern dumping. Test-pit 83, at the east end of the site, was 5 m long (east-west). It contained modern backfill to a depth of more than 1.2 m.

8.5.2 Test-pit 81, excavated in the south-west corner of site in a small area of land outside the line of the road, also located modern backfill to a depth of 1.35 m. The fill included broken-up tarmac, concrete, and other modern material. The gravel surface was not revealed, and the backfill continued beyond the limit of excavation.

8.5.3 A test-pit excavated in a triangular piece of land in the north-east corner of the site, also outside the road corridor, showed that this area survived undisturbed. The test-pit was therefore extended into a full 30 m trench (82) (Figures 16 and 17). The trench was excavated to the top of the natural gravel, which was reached at an average depth of 0.6 m. A north-east to south-west aligned ditch (82/7), some 1.2 m wide and 0.4 m deep, was cut into the natural gravel in the centre of the trench. The two fills (82/8 and 82/13) of the ditch produced a substantial quantity of struck and burnt flint and three small sherds of prehistoric pottery. A small circular feature (82/9) which appeared to be a pit truncated by later ploughing lay 2 m to the east of the ditch. A single posthole (82/11) was found at the east end of the trench. Neither the pit nor the posthole produced any finds. A number of tree throw pits were also observed in the top of the natural gravel. All of the features were sealed beneath a deposit of sandy clay (82/3) which appeared to be alluvial, although it may have been disturbed by cultivation.

8.6 ARTEFACTS RETRIEVED

8.6.1 Flint

8.6.1.1 An assemblage of 12 pieces of struck flint and 26 pieces of burnt unworked flint were recovered from the evaluation. The majority of the worked flint came from the upper fill (82/8) of ditch 82/7; the lower fill (82/13) contained a smaller assemblage (see below for details). The flint is fairly good quality and seems to be similar to raw materials found at the Staines causewayed enclosure (Healey and Robertson-Mackay 1987, 1-3).

Context	Typology
82/8	2 chips
	6 flakes
	1 ?fabricator
	19 burnt unworked flints
82/13	2 flakes
	1 single platform flake core (180 g)
	7 burnt unworked flints

Table 9: Yeoveney Lodge, flint typology

8.6.1.2 Both hard and soft hammers were used; flakes tend to be short and squat. A fabricator with crushed distal and proximal ends (context 82/8) seems to have been used for repeated striking or rubbing functions. A bronze age date would not be out of place for this artefact. Heavily burnt unworked flint is also commonly found on bronze age sites (although not exclusively so). The material from contexts 82/8 and 82/13 would not be out of place in a bronze age context although the use of soft hammers may imply an earlier element to the flintwork. In the absence of diagnostic forms it is, however, difficult to assess the possible earlier element at this stage.

8.6.2 PREHISTORIC POTTERY

8.6.2.1 The upper fill (82/8) of ditch 82/7 contained three plain body sherds and eight crumbs of earlier prehistoric pottery weighing a total of 13 g. The sherds are 10 mm thick and have been tempered with angular flint. This material includes no featured/diagnostic sherds and therefore could be either neolithic or bronze age in date.

8.7 DISCUSSION

8.7.1 The evaluation has established the presence of archaeology in the north-east corner of the site. A ditch dated to the late neolithic/bronze age period was located, along with a pit and a posthole. The substantial assemblage of flintwork and burnt flints from the ditch is notable, especially in the context of the relatively small excavated segment. The density of finds and

features strongly suggests the presence of an occupation site in the vicinity. Given the position and date of the features, it would appear that these remains are related to those found in the area to the east of the site, at Church Lammas.

8.7.2 The evaluation has also shown, however, that any archaeological remains on the line of the original Staines Bypass, which constitutes some 75 % of the site, has been severely truncated or destroyed. It is possible that the bottom of deep features could survive at the west end of the site, where the disturbance from the road appeared to be shallower. The natural gravel was located at a depth of 0.6 m below the present ground surface in this area, although this may not be the original surface level. It seems clear that the top of the natural gravel was lowered during construction or landscaping for the road. Furthermore the gravel surface had suffered severe compaction, while modern material had become incorporated in its surface.

8.7.3 The natural gravel was not exposed in test-pit 83 at the east end of the area, even though the gravel surface had been exposed at a typical depth of 0.6 m immediately to the north in trench 82. Taking account of the relative surface levels of the two excavations, the gravel should have appeared at a depth of 0.5-0.6 m in test-pit 83. Similarly, the gravel surface was not revealed within the excavated depth of 1.35 m in test-pit 81, although the evidence from test-pit 80 suggests that the surface (whether or not truncated) would have lain at a depth of about 0.6 m. The depth and type of backfill located in the south-west corner of the site suggests that this area has been subjected to gravel extraction, probably to establish a pit to dispose of material from the dismantling of the road.

Context	Type	Width m	Depth m	Artefacts	Comments
80/1	Topsoil	-	0.15	-	Modern
80/2	Layer	-	0.32	-	Modern dumping
80/3	Layer	-	0.10	-	Modern
80/4	Natural	-	-	-	Gravel
81/1	Topsoil	-	0.13	-	Modern
81/2	Layer	-	0.52	-	Modern dumping
81/3	Layer	-	0.23	-	Modern backfill
81/4	Layer	-	0.43	-	Modern backfill
82/1	Topsoil	-	0.21	-	Modern
82/2	Layer	-	0.23	-	Buried ploughsoil
82/3	Layer	-	0.20	-	Buried ploughsoil
82/4	Natural	-	-	-	Silty sand
82/5	Tree hole	-	-	-	Not excavated
82/6	Fill	-	-	-	Fill of 82/6
82/7	Ditch	1.10	0.39	-	N-S aligned U shaped profile
82/8	Ditch	-	0.14	8 flint flakes, 1 tool, 19 pieces of burnt flint, 3 pieces of prehistoric pot	Fill of 82/7
82/9	Pit?	1.00	0.29	8 flint flakes, 1 flint tool (fabricator), 19 pieces of burnt flint, 3 sherds of prehistoric pot	Plough truncated?
82/10	Fill	-	0.29	-	Fill of 82/10
82/11	Post hole	0.40	0.12	-	
82/12	Fill	-	0.12	-	Fill of 82/11
82/13	Fill	-	0.26	2 flint flakes, 1 flint core, 7 pieces of burnt flint	Fill of 82/7
83/1	Topsoil	-	0.30	-	Modern
83/2	Layer	-	0.90	-	Modern back fill

Table 10: Yeoveney Lodge, context details

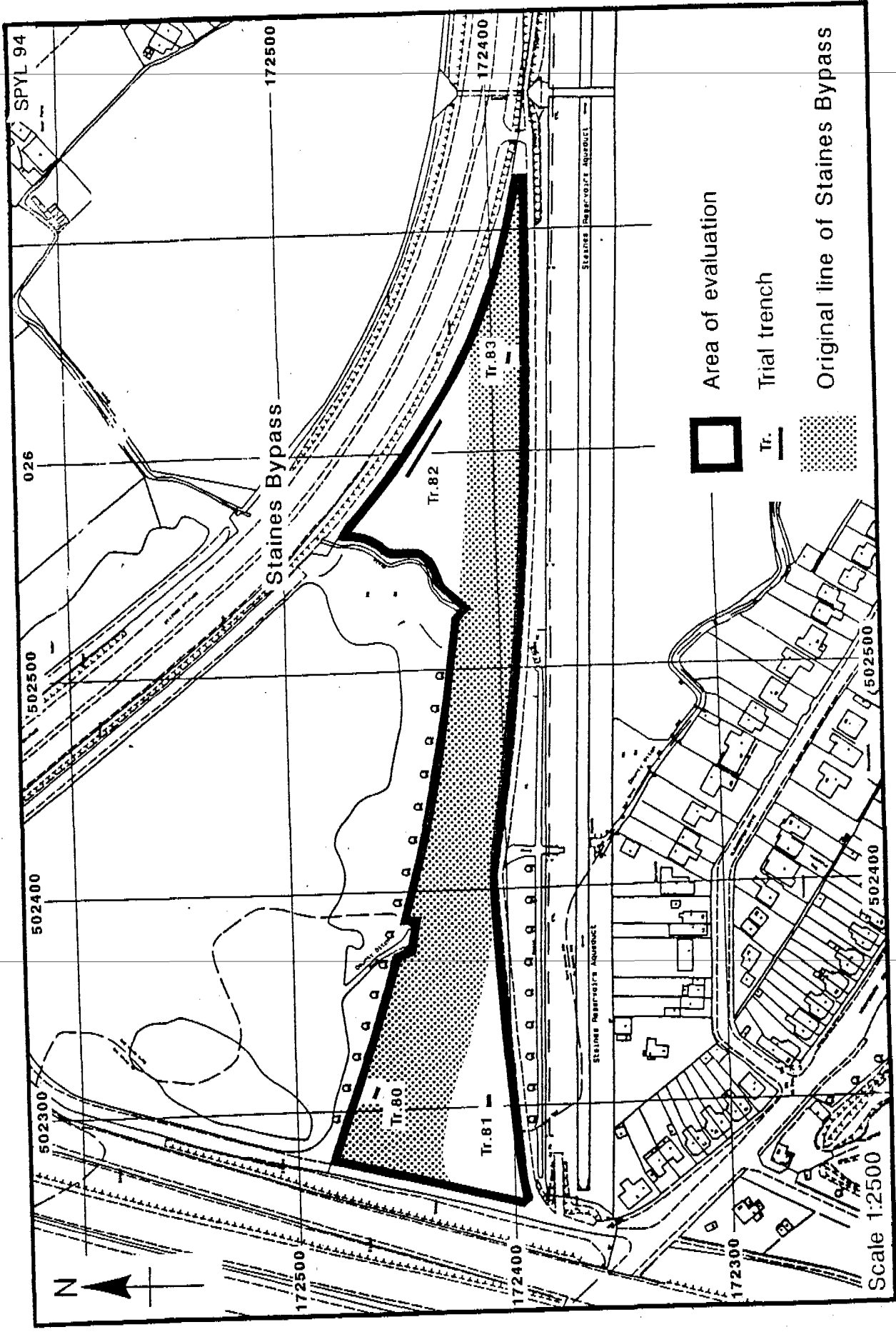

Yeoveney Lodge, trench locations

Figure 16

Trench 82

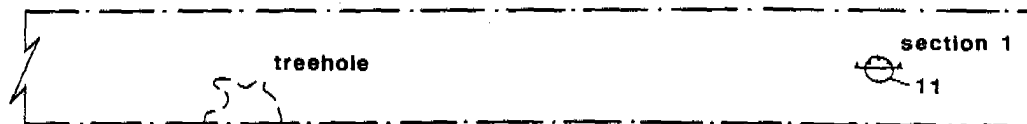
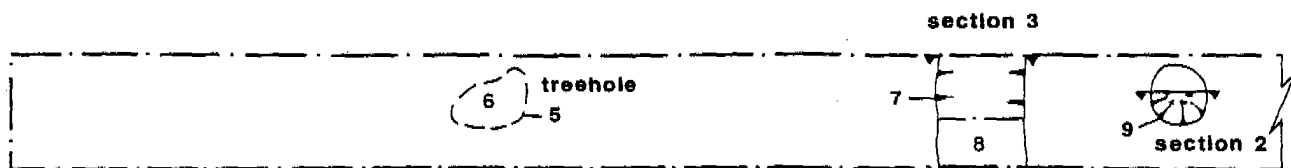

0 5 m

Scale 1:100



Section 1

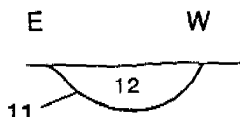

Section 2

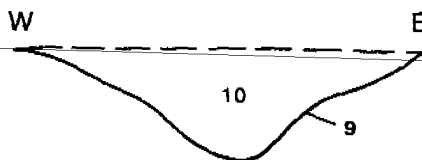

Section 3

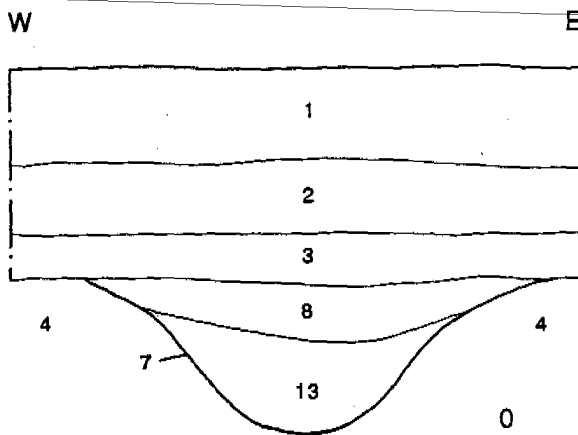

0 1 m

Scale for sections 1:20

Yeoveney Lodge, plan and sections, Trench 82

Figure 17

9.0 CAMBRIDGE KENNELS

9.1 Fieldwork took place at the Cambridge Kennels, Spelthorne, Surrey (Figure 18; NGR TQ 026730, site code SPCK) over a period of five days, 21-25 February 1994. The Cambridge Kennels site is one of the larger areas of land take, and any extensive construction work could have a major impact on any archaeological deposits on the site.

9.2 ARCHAEOLOGICAL BACKGROUND

9.2.1 The site lies on the south-west edge of Staines Moor, which contains a number of probably prehistoric cropmarks; the nearest are approximately 500 m to the east and 575 m to the north-east (ring ditches, possibly bronze age, at TQ 03117316 and TQ 03087346 respectively). The site is also approximately 500 m north of the destroyed Staines Causewayed Enclosure. There was also a cropmark complex c. 500 m to the west at TQ 02207323, in an area which has been extracted for gravel.

9.3 TOPOGRAPHY AND GROUND CONDITIONS

9.3.1 The southern two thirds of the site form the grounds for the Kennels. This area has been quite heavily landscaped, partly from the Kennels development, but also by the building of flood protection banks. The northern third of the area is a small triangle of land immediately to the north of the Kennels. This area is pasture land which appears to have been cultivated in recent times. All of the area is flat, low-lying ground, and prone to flooding. The underlying geology is predominantly gravel. The site had been completely flooded only a month before the fieldwork took place, and the water table was still very high at the time of the evaluation. The ground was therefore saturated, and work was often difficult because of this. Many of the trenches, particularly those in the area of the palaeo-channel, were badly affected by flooding.

9.4 STRATEGY

9.4.1 Nine trenches were excavated (Figure 18); each was to be 30 m in length x 1.6 m wide. Two of the trenches, 34 and 38, were not fully excavated due to the existence of deep modern disturbance. The trenches were numbered in sequence, from 30 to 38.

9.5 RESULTS

9.5.1 Trenches 30, 35, 36, 37 and 38 (associated with the palaeo-channel)

9.5.1.1 The average depth of overburden removed to reveal archaeological features or the top of the natural gravel in this area was 0.5 m.

9.5.1.2 A large linear feature, filled with waterlogged deposits of silt and clay, was located in trenches 30 (Figure 19), 35 (Figure 20), 36 (Figure 21), and 38 (Figure 22). This appeared to be the remains of a north-south aligned palaeo-channel (ancient river bed), running through the west half of the site. Several pieces of preserved, worked wood were found in the top of the palaeo-channel silts in trench 30 (see detail on Figure 19), where only the eastern edge of the channel lay within the trench. The full width of the palaeo-channel was seen only in trenches 35 and 36, where it was some 13-15 m wide. Extensive flooding in these two trenches meant that only machine-excavated sondages could be used to sample the channel, and these showed it to be approximately 1 m deep. No datable finds were retrieved from the channel fills in any of the trenches (but see environmental and wood reports below).

9.5.1.3 Two north-north-west to south-south-east aligned ditches were located immediately to the west of the palaeo-channel, in trench 35 (Figure 20, ditches 35/6 and 35/8). Both of the ditches, which were c. 0.7 m wide, were also filled with waterlogged material. No finds were retrieved from either of the ditches, the deepest of which, 35/8, could not be bottomed due to flooding.

9.5.1.4 Overlying the palaeo-channel in all these trenches, and also overlying the ditches in trench 35, were various deposits of alluvium, some of which were also slightly waterlogged. The waterlogged alluvium also extended into trench 37 (37/4), in the area immediately to the east of the palaeo-channel. No archaeological features were observed in this trench.

9.5.1.5 The palaeo-channel was partially truncated at the north end of the site, in trench 38 (Figure 22), by a large feature of unknown date (feature 38/6). This feature was also sealed beneath deposits of alluvium.

9.5.2 Trenches 31, 32, 33, and 34 (the south-eastern half of the site)

9.5.2.1 No significant archaeological deposits were found in any of these trenches. The only features to be located were a few modern ditches. Extensive modern disturbance had taken place throughout this area, and in all of these trenches deposits containing modern bricks and concrete directly overlaid the natural gravel. The disturbance also extended into the east half of trench 30. Deeper disturbance was seen in trench 34 where intrusions were recorded up to a depth of 1 m.

9.6 ENVIRONMENTAL RESULTS

9.6.1 Five samples were assessed for macroscopic plant and invertebrate remains from palaeo-channel and ditch deposits at Cambridge Kennels. Sample 2 was from a modern feature.

Sample	Context	Description
1	30/4	Dark brown organic silt from palaeo-channel
2	32/6	Dark grey gritty and gravelly very clayey loam from ditch
3	35/7	Grey brown slightly calcareous organic silt from ditch
4	35/9	Grey brown calcareous organic silt from ditch
5	35/11	Brown organic silt from palaeo-channel

Table 11: Cambridge Kennels, environmental sample details

9.6.2 Two hundred and fifty g of each sample was broken up in water, washed over onto a 0.2 mm mesh and the residue sieved over a 0.5 mm mesh. The samples were scanned under a binocular microscope. The results for seeds are listed in table 12 and for mollusca are listed in table 13, + indicating present and ++ indicating abundant. Insect remains are very sparse but sample 1 contains fragments of the beetle *Donacia* or *Plateumaris* sp. and sample 3 contains Trichoptera cases. Waterlogged organic remains are absent from sample 2 and mollusca are absent from samples 1, 2 and 5.

9.6.3 The results from the two palaeo-channel deposits, samples 1 and 5, suggest an abandoned channel in the later stages of silting. The seeds suggest a flora appropriate to shallow stagnant

water, with *Callitriche* sp. (starwort), *Carex* spp. (sedges), *Oenanthe* spp. (water dropwort) and *Mentha* sp. (water mint). The remaining seeds are mostly from plants of mud such as *Ranunculus sceleratus* (celery-leaved crowfoot) but both samples also contain seeds of *Rubus fruticosus* agg. (blackberry). Species of *Donacia* and *Plateumaris* feed on various aquatic and marsh plants. The absence of molluscs possibly resulted from the decay of organic material making conditions too acidic for the survival of shells.

- 9.6.4 The two ditch deposits in which shells are present, samples 3 and 4, supported a floating-leaved aquatic flora of *Ranunculus* S. *Batrachium* sp. (water crowfoot) and *Potamogeton* sp. (pondweed). Marginal vegetation apparently included *Juncus articulatus* gp. (rush) and *Carex* spp. (sedges). Exposed mud is suggested by *Ranunculus sceleratus* (celery-leaved crowfoot) from both samples. The occurrence of shells of the flowing water molluscs *Valvata piscinalis*, *Bithynia tentaculata* and *Pisidium amnicum* shows that the ditches either had water flowing along them or were silted by alluviation from the Thames system.
- 9.6.5 The absence of remains of *Alnus glutinosa* (alder) and the generally open conditions suggested by the seeds would be appropriate to a later prehistoric or historic date for the deposits. The contrast of the samples from archaeological deposits and the material from the modern feature (sample 2) would suggest that samples 1 and 3-5 are Anglo-Saxon at the latest.
- 9.6.6 In the absence of a more extensive archaeological context or date for the deposits, the results from these samples are unexceptional. However, with further archaeological work on the site, more detailed analysis would provide useful background environmental information.

Seeds	1	3	4	5
<i>Ranunculus sceleratus</i>	-	+	+	+
<i>R. S. Batrachium</i> sp.	-	++	++	+
<i>Lychnis flos-cuculi</i>	-	-	-	+
<i>Atriplex</i> sp.	-	+	-	-
<i>Rubus fruticosus</i> gp.	+	-	-	+
<i>Callitriche</i> sp.	++	-	-	-
<i>Oenanthe pimpinelloides</i> gp.	-	+	-	+
<i>O. aquatica</i> gp.	+	+	-	-
<i>Apium nodiflorum</i>	-	-	-	+
<i>Polygonum persicaria</i>	-	-	-	+
<i>Solanum dulcamara</i>	-	-	-	+
<i>Mentha</i> sp.	-	+	-	+
<i>Lycopus europaeus</i>	+	-	+	-
<i>Sambucus nigra</i>	+	-	-	-
<i>Eupatorium cannabinum</i>	-	-	-	+
<i>Alisma</i> sp.	-	+	-	-
<i>Potamogeton</i> sp.	-	++	-	-
<i>Juncus articulatus</i> gp.	-	+	++	-
<i>Sparganium</i> sp.	+	-	-	-
<i>Schoenoplectus lacustris</i>	-	-	+	-
<i>Eleocharis S. Palustres</i> sp.	-	+	-	+
<i>Carex</i> spp.	++	++	+	+
<i>Glyceria</i> sp.	-	-	-	+

Table 12: Cambridge Kennels, details of seeds from samples 1 and 3-5

Molluscs	3	4
<i>Valvata piscinalis</i>	-	+
<i>Bithynia tentaculata</i>	+	+
<i>Pisidium amnicum</i>	-	+

Table 13: Cambridge Kennels, details of molluscs in samples 3 and 4

9.7 WOOD

9.7.1 One piece of the worked wood from the top of the palaeo-channel silts in trench 30 (30/1) was retrieved for analysis. The wood is diffuse and porous, and is most likely to be coppiced hazel. It has been radially split from a pole 60 mm in diameter, and fashioned into a point at one end using an axe. The wood appears to have been somewhat decayed before preservation began, but the subsequent preservation by waterlogging is very good. It is not possible to give a precise date for the object. The wood's state of structural decay, however, suggests that it is unlikely to be earlier than Roman or later than medieval in date.

9.8 DISCUSSION

9.8.1 The palaeo-channel and the associated ditches cannot be closely dated at this stage. No artefacts were recovered from any of the features, but it is apparent that they were sealed by alluvium. The general sequence of overbank flooding in this area is imperfectly understood, but one would expect alluvial deposition to have begun by the early medieval period at the latest (information from Dr Mark Robinson). The environmental material and the worked wood would be consistent with a later prehistoric, Roman or Anglo-Saxon date for the palaeo-channel.

9.8.2 The modern disturbance throughout the east half of the site appears to be the result of landscaping. This is likely to have removed all traces of alluvium from the area. There was no evidence for the survival of pre-modern archaeological features under the landscaping deposits.

Context	Type	Width m	Depth m	Artefacts	Comments
30/1	Topsoil	-	0.17	-	Modern
30/2	Layer	-	0.07	-	Modern dumping
30/3	Layer	-	0.35	Modern brick and tile	Modern dumping
30/4	Palaeo-channel deposit	-	0.25	Preserved worked wood	Waterlogged
30/5	Natural	-	-	-	Gravel
30/6	Layer	-	0.08	Modern brick and tile	Modern dumping
30/7	Layer	-	0.30	Modern brick and tile	Fill of modern disturbance 30/8
30/8	Disturbance	-	0.30	-	Modern
30/9	Palaeo-channel	>9.00	>0.50	-	N-S aligned
31/1	Topsoil	-	0.37	-	Modern
31/2	Layer	-	0.11	-	Modern dumping
31/3	Layer	-	0.04	-	Gravel dump
31/4	Layer	-	0.19	Modern brick and tile	Modern dumping
31/5	Natural	-	-	-	Clay and gravel
31/6	Fill	-	0.39	Modern tile and glass	Fill of 31/7
31/7	Ditch	0.60	0.39	-	Modern
32/1	Topsoil	-	0.34	-	Modern
32/2	Layer	-	0.16	-	
32/3	Ditch	2.06	0.44	-	Modern
32/4	Fill	-	0.15	1 flint flake	Fill of 32/3
32/5	Fill	-	0.21	-	Fill of 32/3
32/6	Fill	-	0.12	-	Fill of 32/3
32/7	Natural	-	-	-	Clay and gravel
32/8	Ditch	-	-	-	Modern, not excavated
33/1	Topsoil	-	0.24	-	Modern
33/2	Layer	-	0.15	Modern brick and tile	Modern dumping
33/3	Layer	-	0.26	-	Alluvium
33/4	Natural hollow	-	0.14	-	
33/5	Natural	-	-	-	Clay and gravel
34/1	Topsoil	-	0.30	-	Modern
34/2	Layer	-	1.00	Modern brick and tile	Modern dumping

Context	Type	Width m	Depth m	Artefacts	Comments
34/3	Natural	-	-	-	Clay sand
35/1	Topsoil	-	0.20	-	Modern
35/2	Layer	-	0.10	-	Buried ploughsoil?
35/3	Layer	-	0.12	-	Alluvium
35/4	Layer	-	0.15	-	Alluvium
35/5	Layer	-	0.15	-	Alluvium
35/6	Ditch	0.70	0.20	-	NW-SE aligned
35/7	Fill	-	0.20	-	Fill of 35/6: Waterlogged
35/8	Ditch	0.70	0.30	-	NW-SE aligned: Not fully excavated
35/9	Ditch fill	-	0.30	-	Waterlogged fill of 35/8
35/10	Natural	-	-	-	Silt
35/11	Palaeo-channel deposit	-	0.50	-	Waterlogged
35/12	Natural	-	-	-	Gravel
35/13	Paleochannel	12.00	0.50	-	N-S aligned
35/14	Layer	-	0.14	-	Alluvium
35/15	Pipe	0.08	-	-	Modern cable
35/16	Pipe trench	-	0.50	-	Modern
36/1	Topsoil	-	0.24	-	Modern
36/2	Layer	-	0.12	Modern tile	Buried ploughsoil?
36/3	Layer	-	0.32	-	Alluvium
36/4	Layer	-	0.20	3 pieces of tile, 1 piece of animal bone	Alluvium
36/5	Fill	-	0.30	-	Fill of 36/6
36/6	Tree hole pit	-	0.30	-	Part excavated
36/7	Palaeo-channel deposit	-	0.67	-	Waterlogged
36/8	Palaeo-channel	15.00	0.67	-	N-S aligned
36/9	Natural	-	-	-	Gravel
37/1	Topsoil	-	0.16	-	Modern
37/2	Layer	-	0.14	-	Buried ploughsoil?
37/3	Layer	-	0.18	-	Alluvium
37/4	Layer	-	0.14	-	Waterlogged alluvium
37/5	Natural	-	-	-	Gravel

Context	Type	Width m	Depth m	Artefacts	Comments
38/1	Topsoil	-	0.22	-	Modern
38/2	Layer	-	0.10	-	Buried ploughsoil?
38/3	Layer	-	0.05	-	
38/4	Layer	-	0.15	-	Alluvium
38/5	Layer	-	0.15	-	Alluvium
38/6	Feature	>1.10	0.40	-	Function unknown
38/7	Layer	-	0.11	-	Fill of 38/6
38/8	Layer	-	0.06	-	Fill of 38/6
38/9	Layer	-	0.22	-	Fill of 38/6
38/10	Palaeo-channel	-	-	-	N-S aligned
38/11	Palaeo-channel deposit	-	-	-	Waterlogged: not excavated
38/12	Natural	-	-	-	Gravel

Table 14: Cambridge Kennels, context details

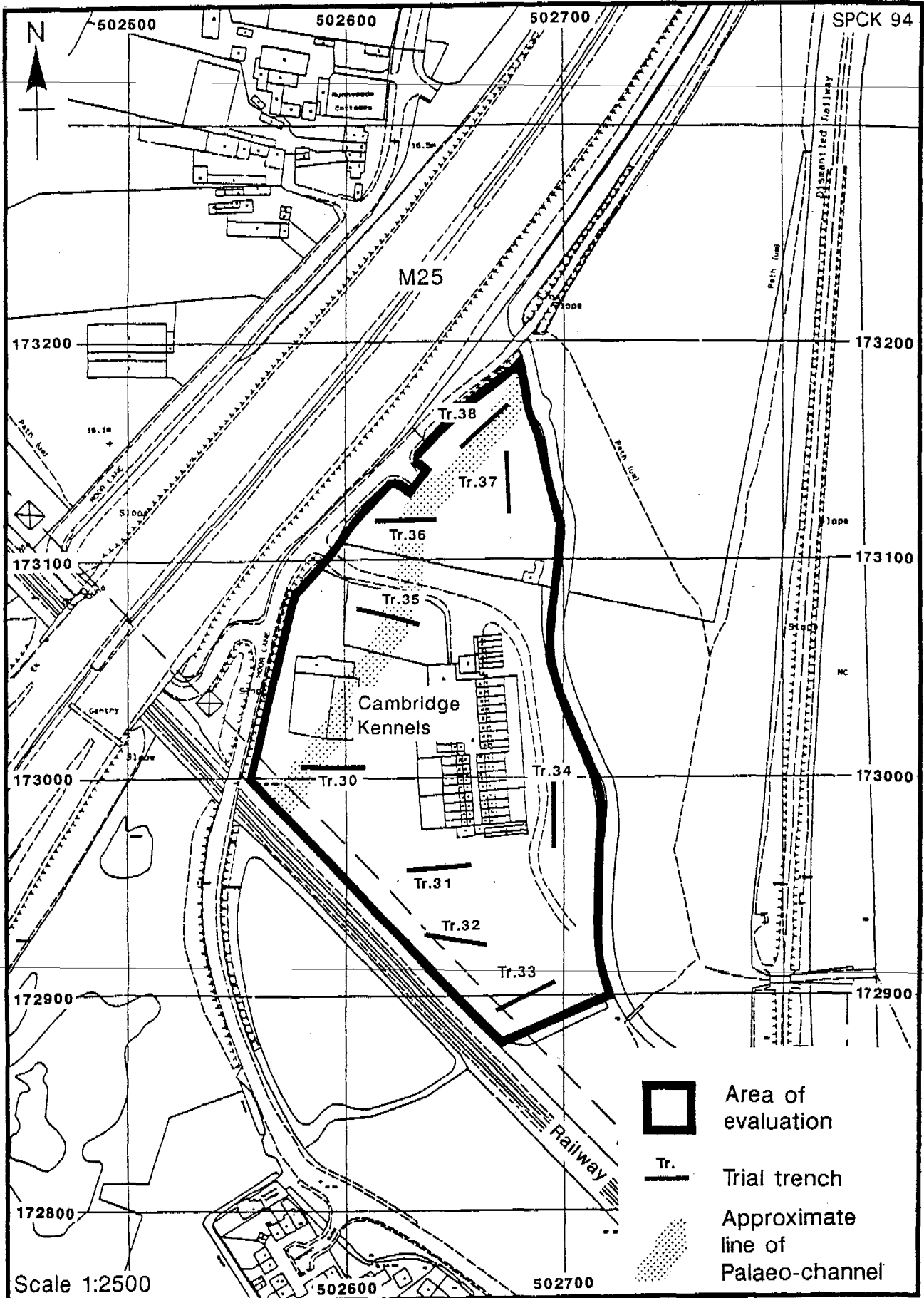

Cambridge Kennels, trench locations

Figure 18

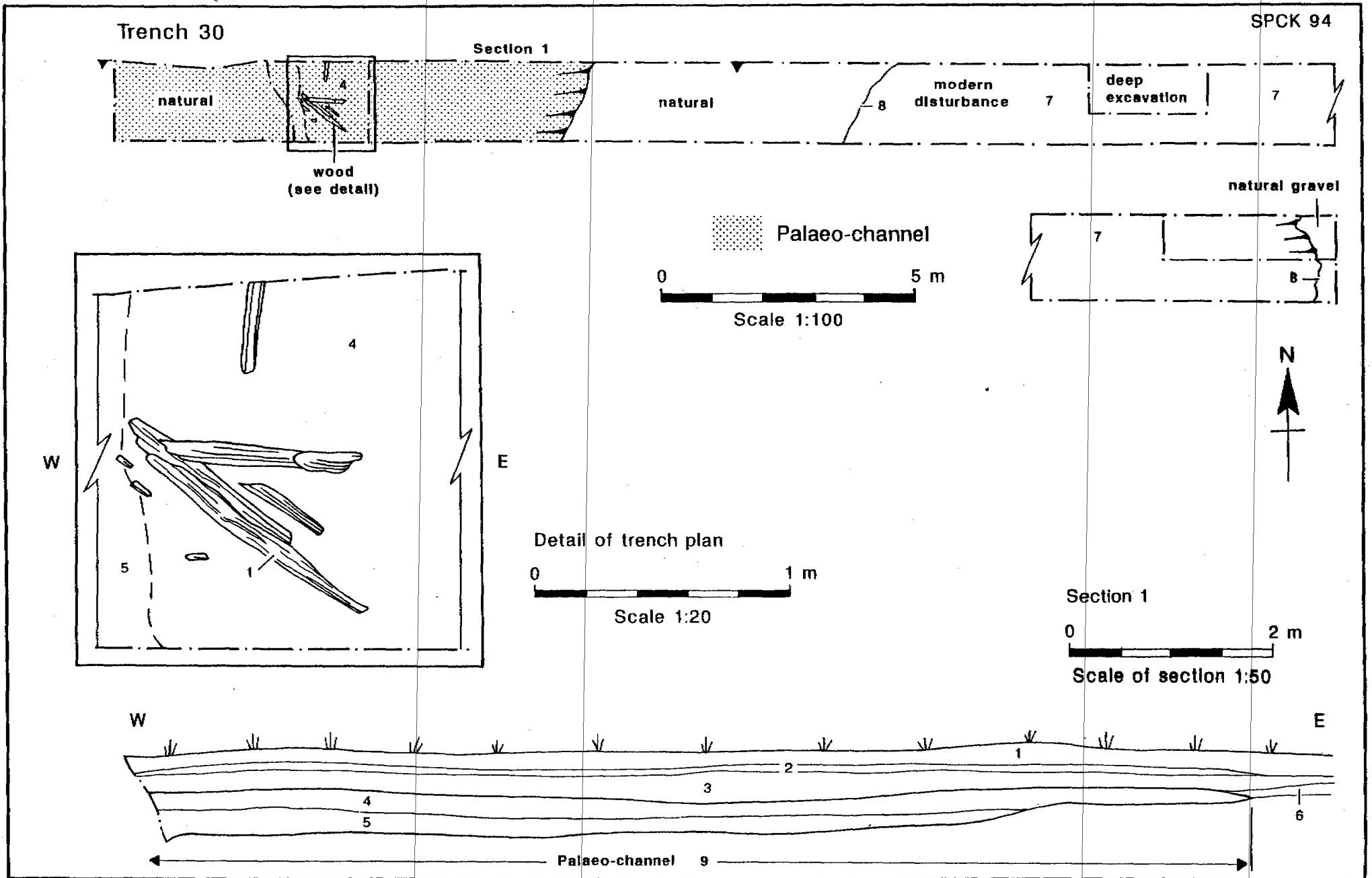

Cambridge Kennels, plans and section, Trench 30

Figure 19

Trench 35

SPCK 94

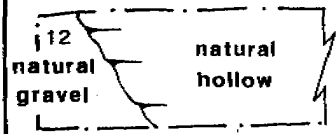

Palaeo-channel

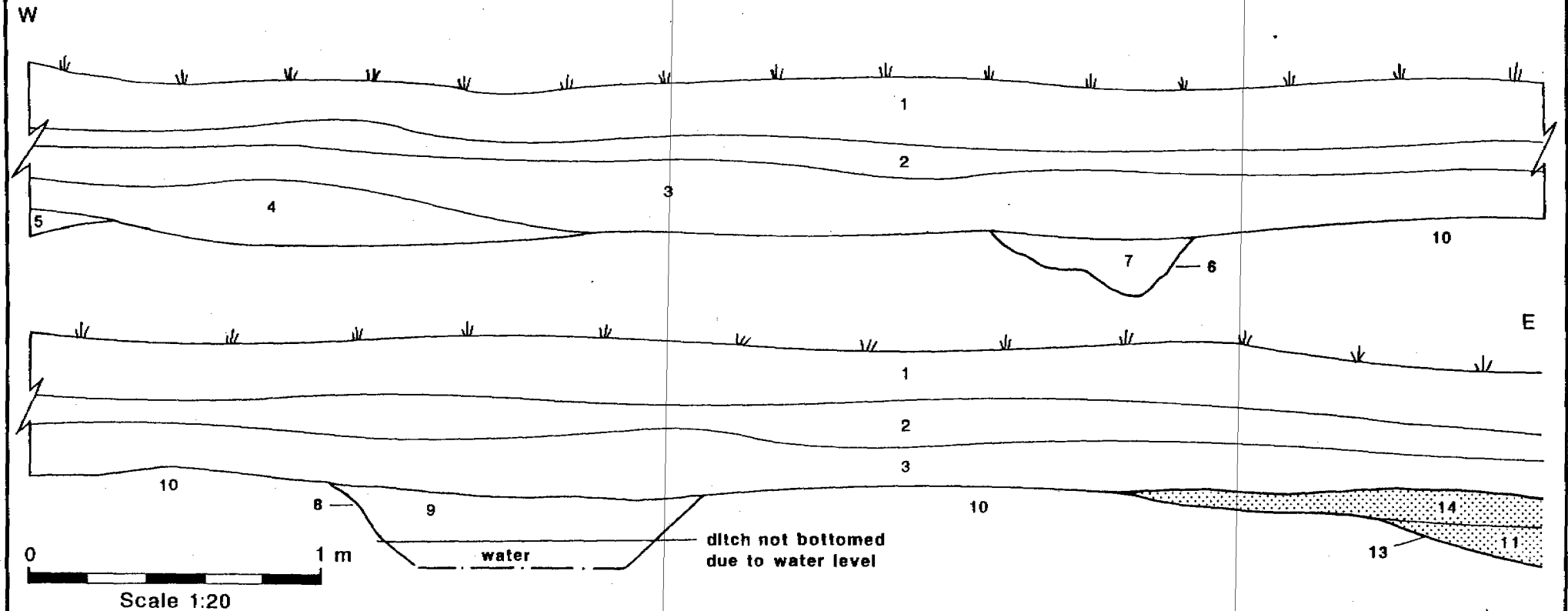
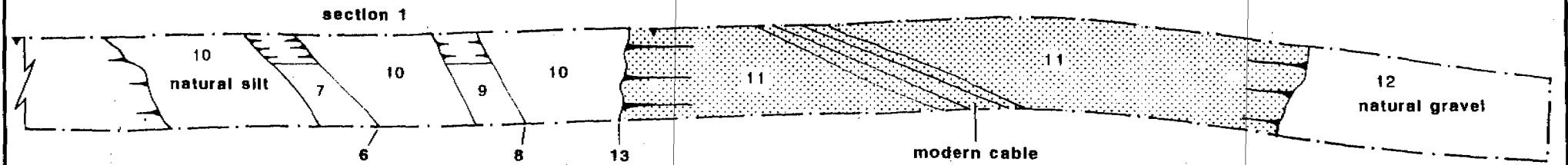
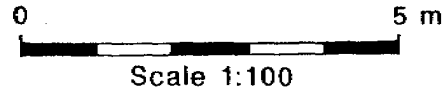

Cambridge Kennels, plan and section, Trench 35

Figure 20

Trench 36

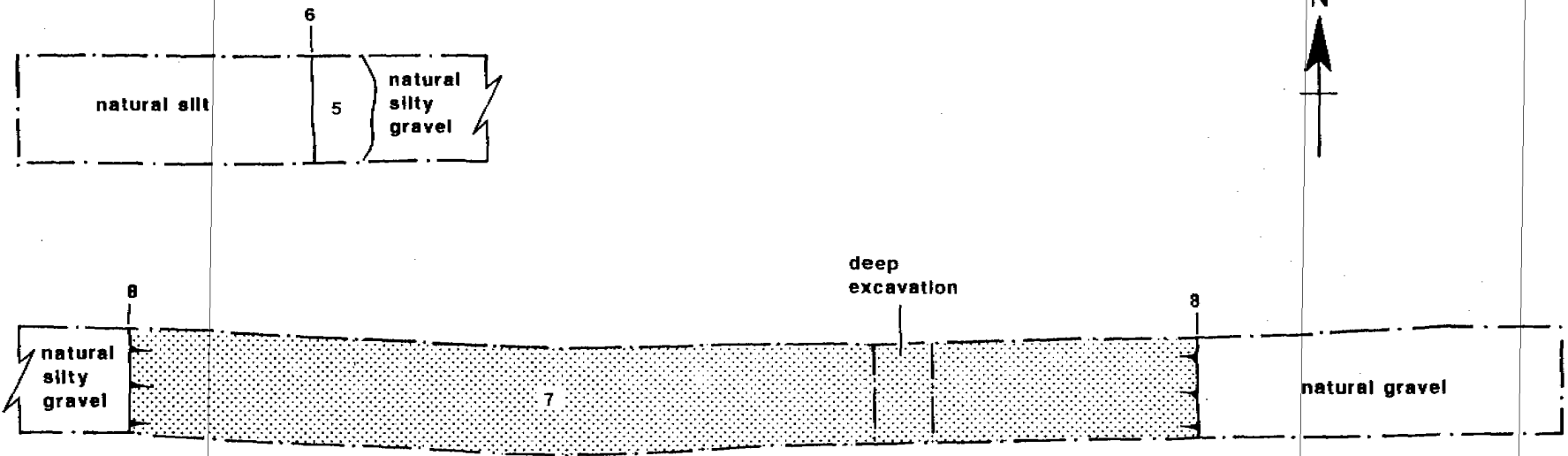

Palaeo-channel

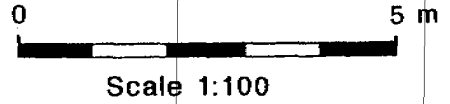

Cambridge Kennels, plan, Trench 36

Figure 21

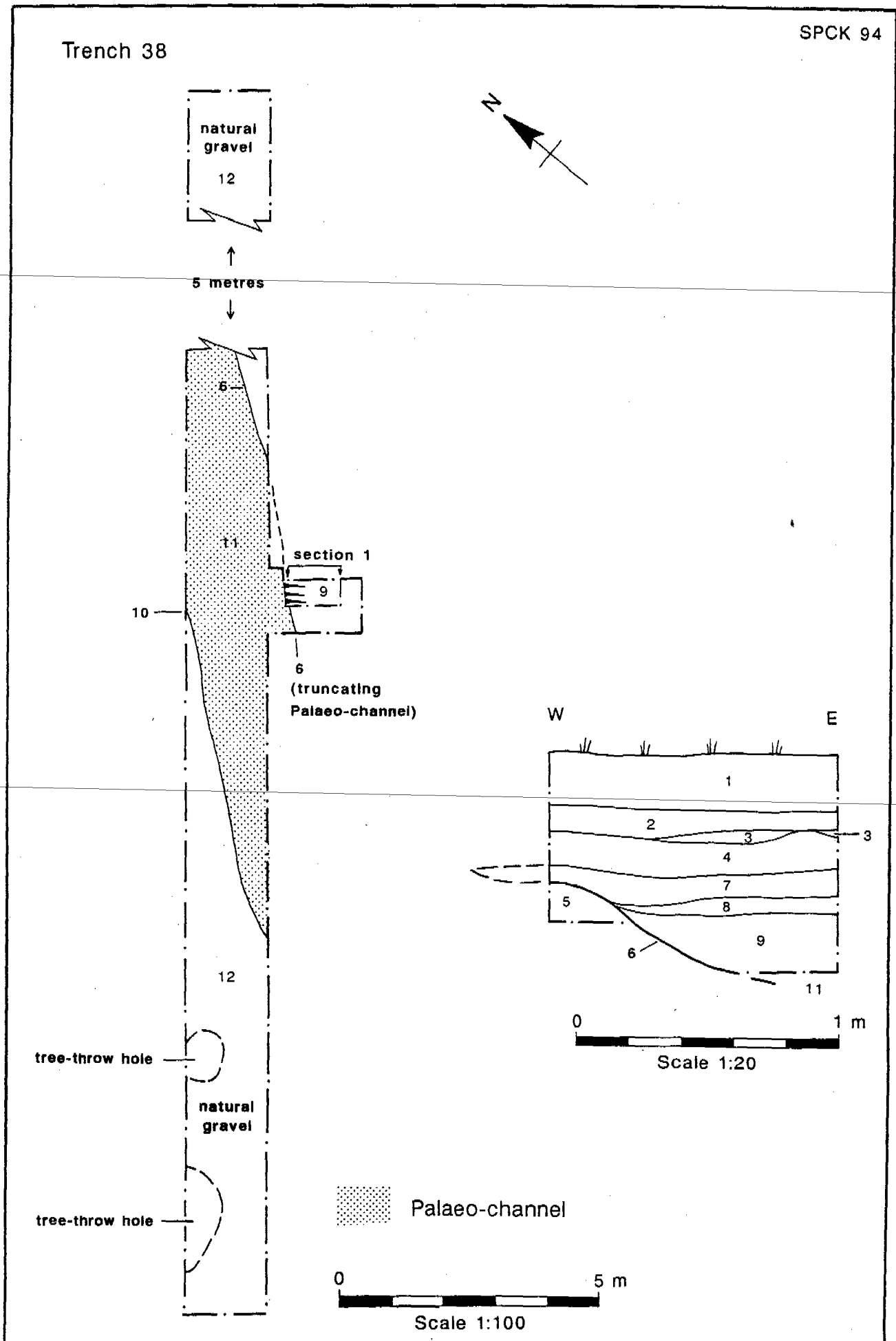

Cambridge Kennels, plan and section, Trench 38

Figure 22

10.0 POYLE MEADOWS

10.1 Fieldwork took place at Poyle Meadows, Spelthorne, Surrey (Figure 23; NGR TQ 035752, site code SPPM) on 28 February 1994.

10.2 ARCHAEOLOGICAL BACKGROUND

10.2.1 The area of proposed land take is adjacent to the north-east corner of Wraysbury Reservoir, on the south-west side of M25 Junction 14. The reservoir covered the medieval chapel of Yeoveney, while a possible prehistoric enclosure and ring ditch lay at the north-east corner of the reservoir. Further evidence for prehistoric activity in the area was found immediately east of Junction 14, where a complex of enclosures, ditches, ring ditches and pits was destroyed during construction work.

10.3 TOPOGRAPHY AND GROUND CONDITIONS

10.3.1 The area on the south-west side of Junction 14 is bounded to the west by a dismantled railway. A pond to the south is believed to be associated with the construction of the railway. There was considerable uncertainty as to whether part or all of the site had been extracted for gravel, either during the construction of the railway or at a later date. Geotechnical information in the form of test-pits and boreholes from 1974 and later suggested that the site might be intact. It appeared that some landscaping had taken place, however, and the extant plant species on the site are broadly characteristic of those found ground which has been used for rubbish disposal.

10.4 STRATEGY

10.4.1 Five 30 m x 1.6 m trenches were to be excavated if it was found that the land had not been extracted. This would represent a 2 % sample of the evaluation area. If backfilled extraction was discovered, however, only test-pits would be needed to establish the extent of the extraction. In the event one short trench and three test-pits were excavated (Figure 23). The trench and test-pits were excavated down to the top of the natural gravel, or to a maximum depth of 1.2 m where modern backfill was located, using a JCB mechanical excavator. The trench and test-pits were numbered in sequence, from 41 to 43. The test-pit west of trench

42 was not numbered separately from the trench.

10.5 RESULTS

10.5.1 Close inspection of the site revealed that a clearly defined change in the vegetation appeared to form a north-south boundary line, some 8 m out from the east edge of the site (Figure 23). A 7 m-long trench (trench 42) was therefore excavated at right-angles across this line. The trench showed that this was indeed an indication of the underlying deposits. A very clear extraction edge was found (Figure 24). Undisturbed gravel therefore only survives in a narrow strip along the edge of the site.

10.5.2 The test-pit excavated at the west end of trench 42 and the other two test-pits contained modern backfill to a depth of more than 1.2 m. Excavation could not proceed beyond this depth for health and safety reasons. The geotechnical excavations all had to be stopped at about this level (or even higher in some cases) because of groundwater inflow and subsequent instability of the pit edges.

10.6 DISCUSSION

10.6.1 The geotechnical report on a pit excavated in the centre of the evaluation area suggested that the natural gravel survived undisturbed. The trench and test-pits, however, show that the site has been extracted and infilled. This discrepancy can be explained by the year (1974) in which the relevant geotechnical pit was dug. Extraction must have taken place after that date, perhaps during construction works on the M25.

10.6.2 Several geotechnical surveys have examined the east edge of the site. All of these surveys suggest that this marginal zone is undisturbed. The evidence from trench 42 supports this conclusion. The zone of survival is very narrow, however, and it is bisected by a stream which runs along the east edge of the site. The evaluation therefore suggests that there is a minimal chance of archaeological deposits surviving within the land take area.

SPPM 94

Context	Type	Depth m	Comments
41/1	Topsoil	0.17	Modern
41/2	Layer	>0.80	Modern backfill
42/1	Topsoil	0.12	Modern
42/2	Layer	>1.40	Modern backfill
42/3	Natural	-	Gravel
43/1	Topsoil	0.40	Modern
43/2	Layer	>0.60	Modern backfill

Table 15: Poyle Meadows, context details

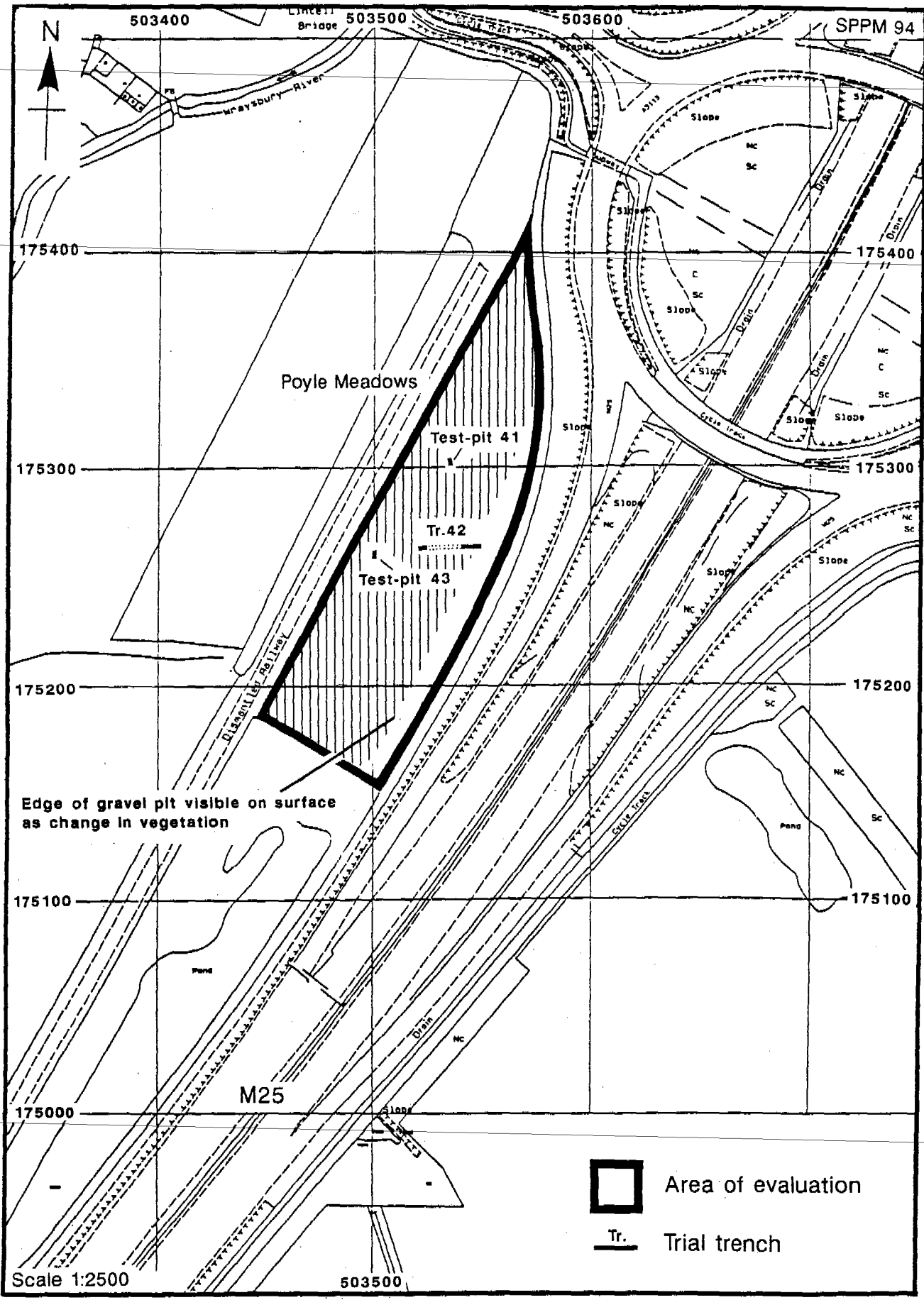

Poyle Meadows, trench locations

Figure 23

Trench 42

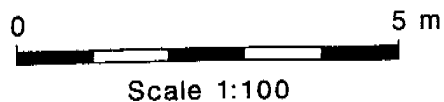
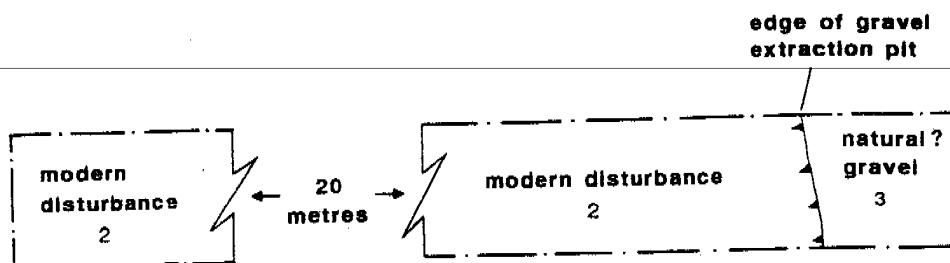

REFERENCES

Hayman G N 1987, *A late Neolithic to early Bronze Age farmstead at Lower Mill Farm, Stanwell*, Surrey County Archaeological Unit

Healey E and Robertson-Mackay R 1983, The Lithic Industries from Staines Causewayed Enclosure and their Relationship to other Earlier Neolithic Industries in Southern Britain, *Lithics* 4, 1-27

Johnson B 1975, *Archaeology and the M25*, Surrey Archaeological Society Monograph

O'Connell M 1986, *Petters Sports Field, Egham: Excavation of a Late Bronze Age/Early Iron Age Site*, Research Volume of the Surrey Archaeological Society 10

Robertson-Mackay R 1984, The Neolithic causewayed enclosure at Staines, Surrey: excavations 1961-63, *Proceedings of the Prehistoric Society* 53, 23-128