



Tel: (0602) 514823

Fax: (0602) 514824

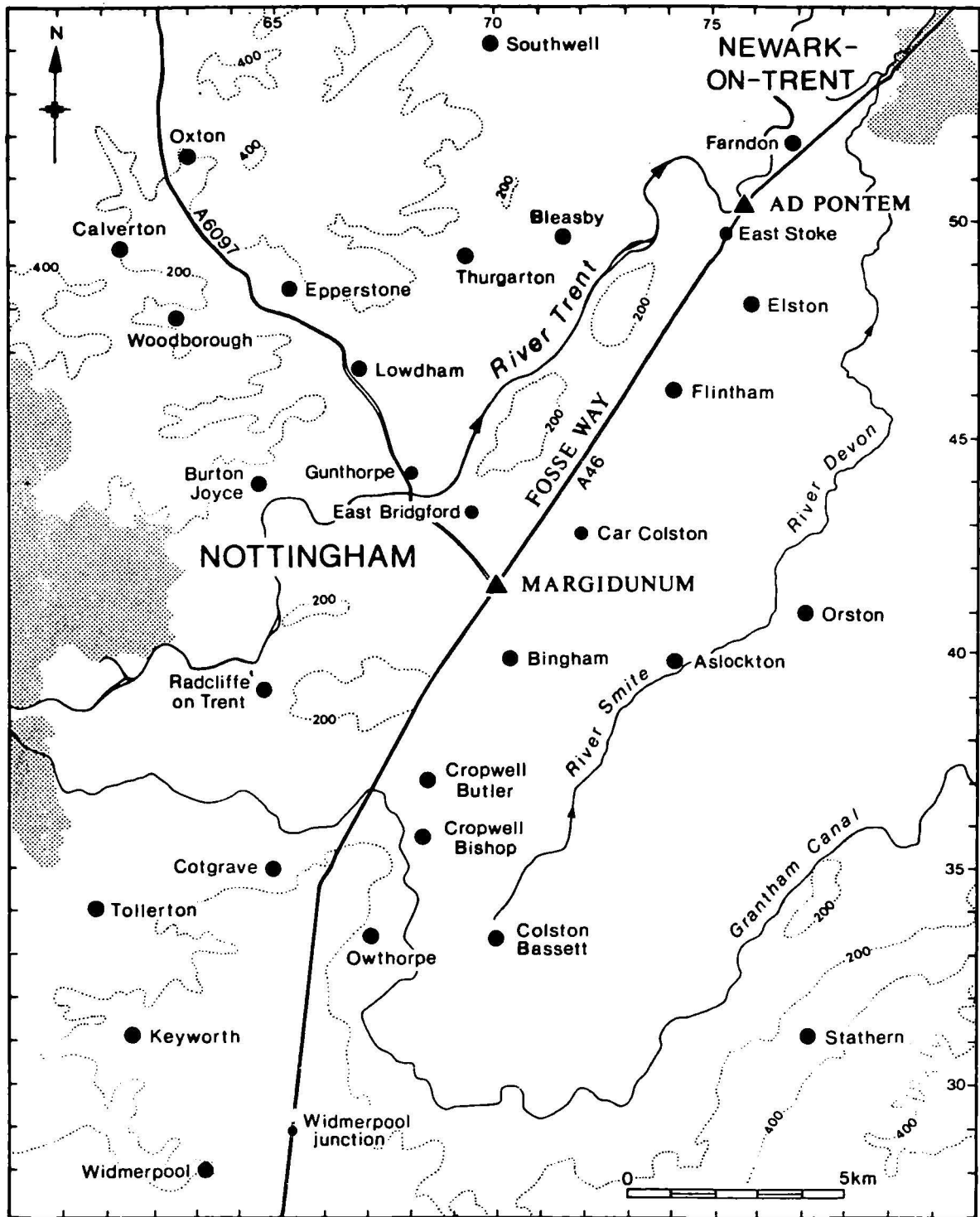

Figure 1. Location of Fosse Way, Widmerpool-Newark.

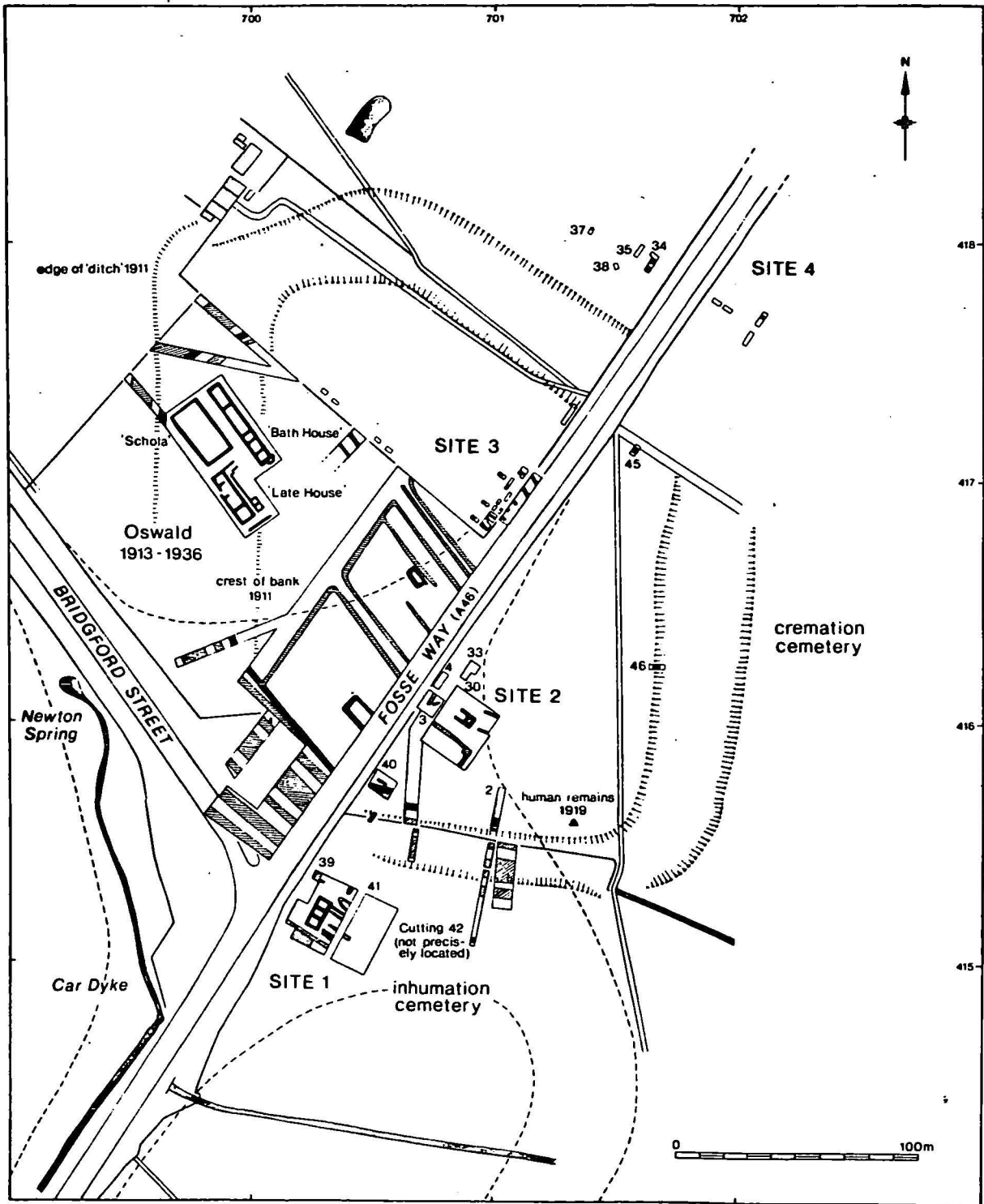

Figure 5. *Margidurum*: Previous excavations in the defended area.

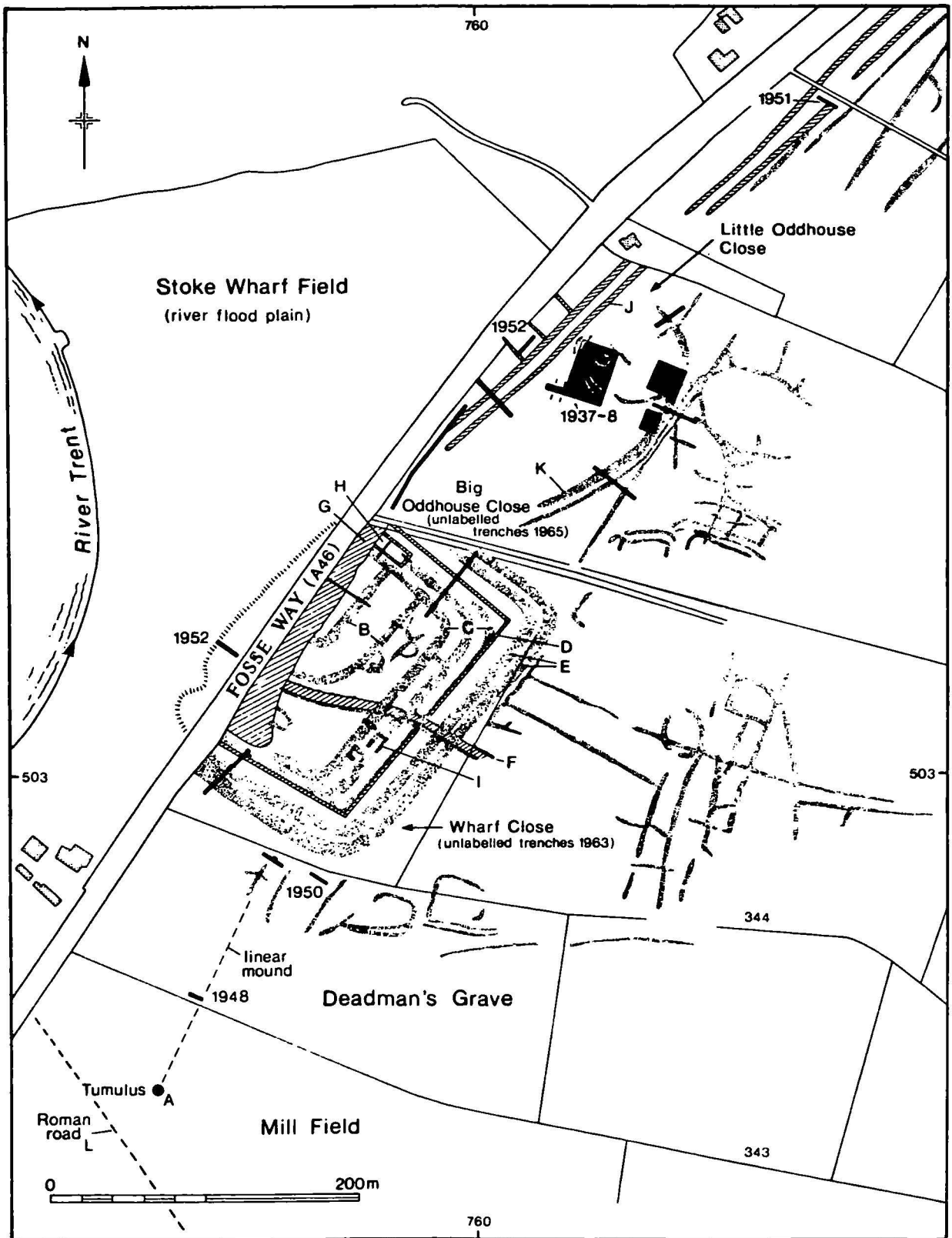

Figure 23. *Ad Pontem*: Plan of cropmark features and excavation areas in the vicinity of the defended area; letters refer to sites mentioned in the text (Sections 1.4.5 and 1.4.6).



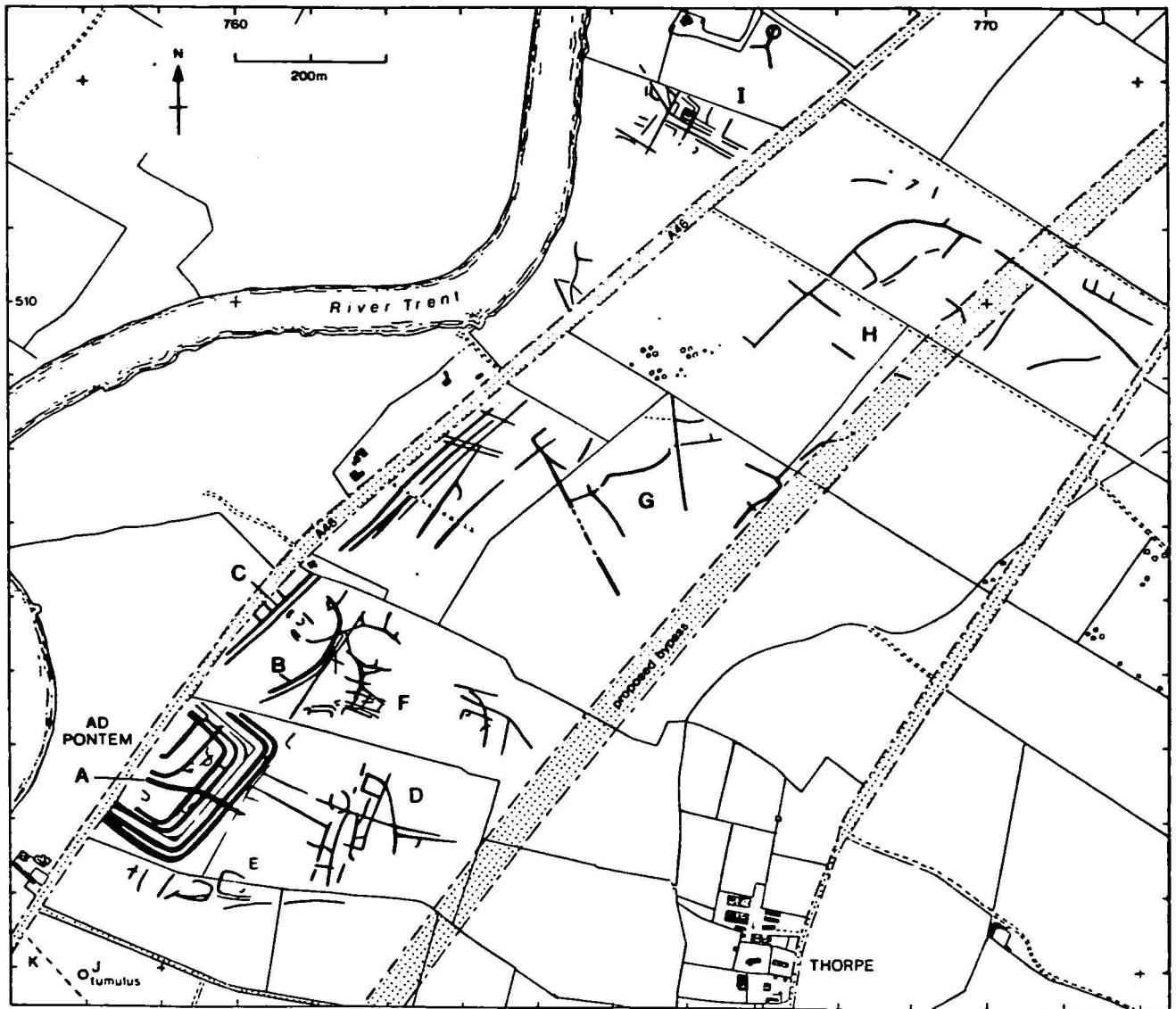

Figure 31. Site 16 (A-K): Cropmarks and finds concentrations in the environs of Ad Pontem.

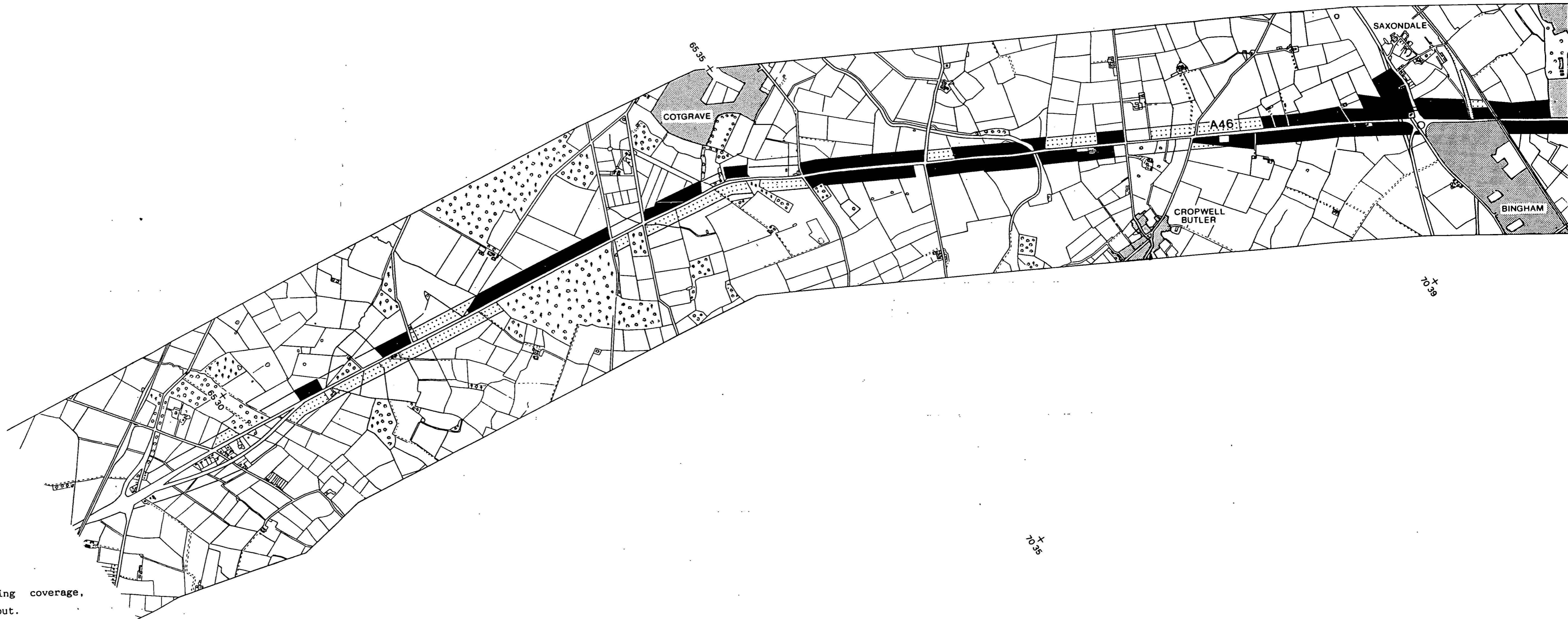

Figure 42. Extent of fieldwalking coverage, Widmerpool to Saxondale roundabout.

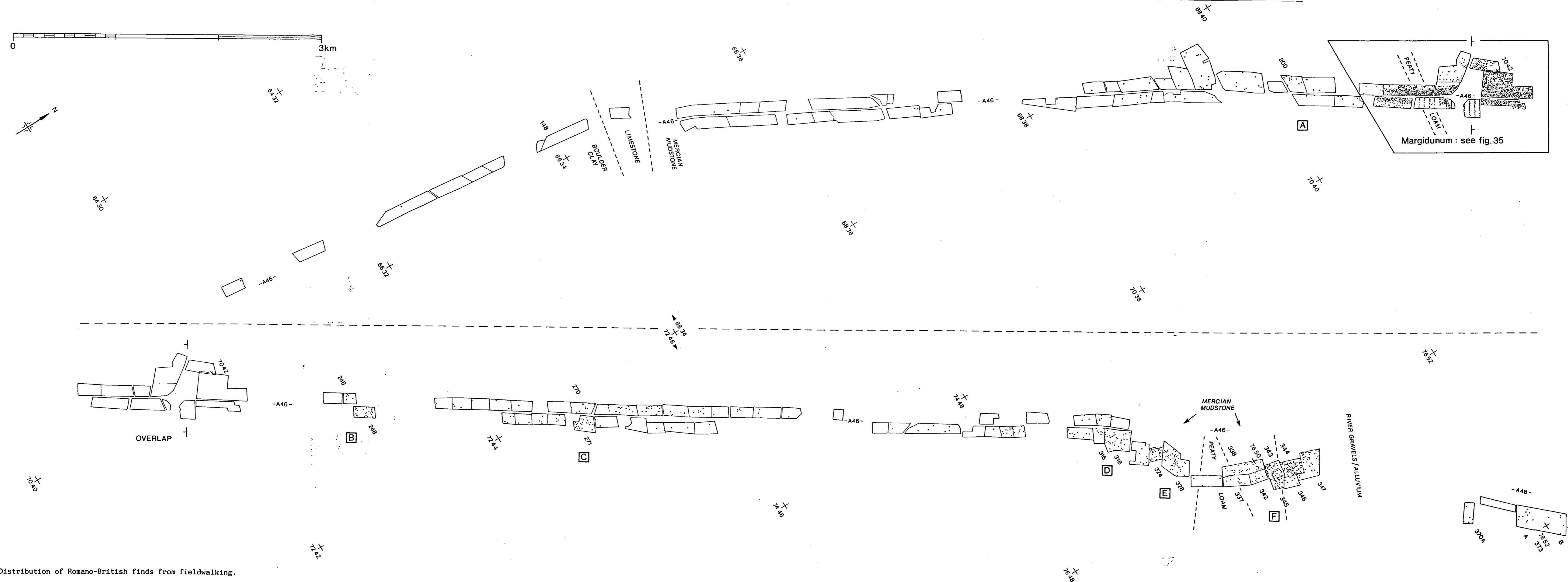

Figure 40. Distribution of Romano-British finds from fieldwalking.







75 X

70 X

Available for fieldwalking:

-  walked
-  not walked

Unavailable for fieldwalking:

-  woodland
-  nursery
-  grassland

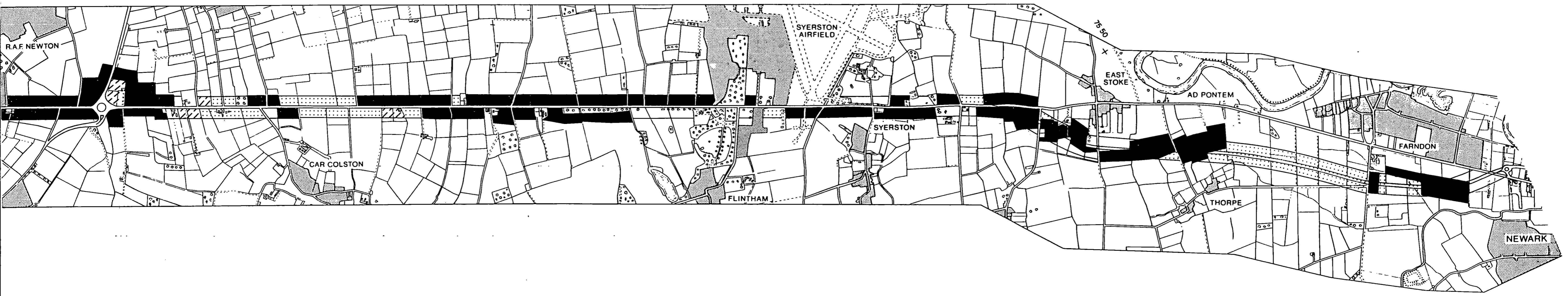
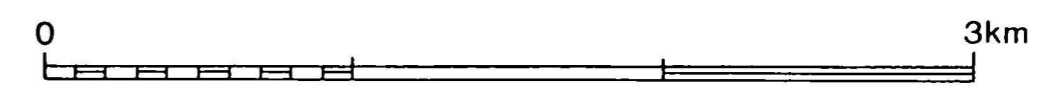

Figure 43. Extent of fieldwalking coverage, Margidunum to Farndon.

75 X



79 50 X





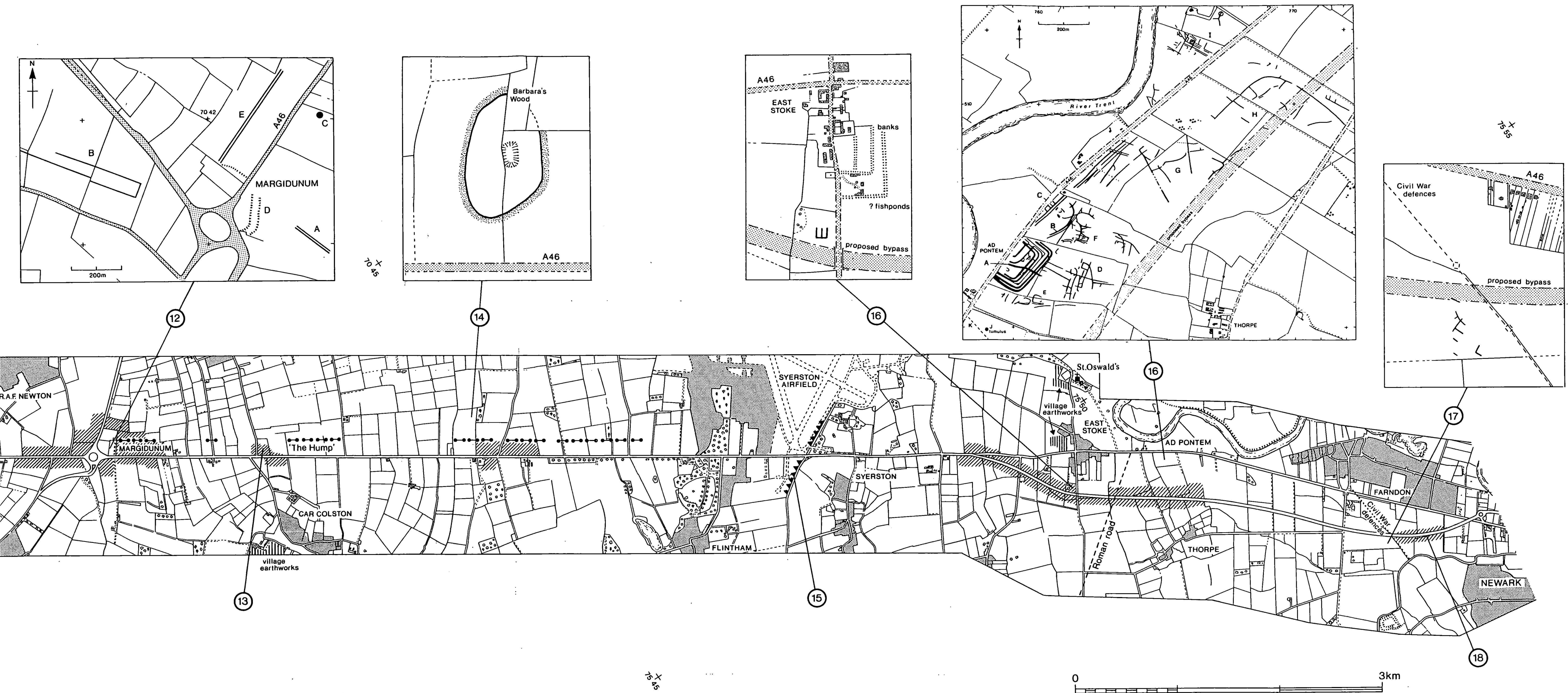

Figure 37. Principal sites threatened by the proposed road, Margidunum to Farndon (Sites 12-18).

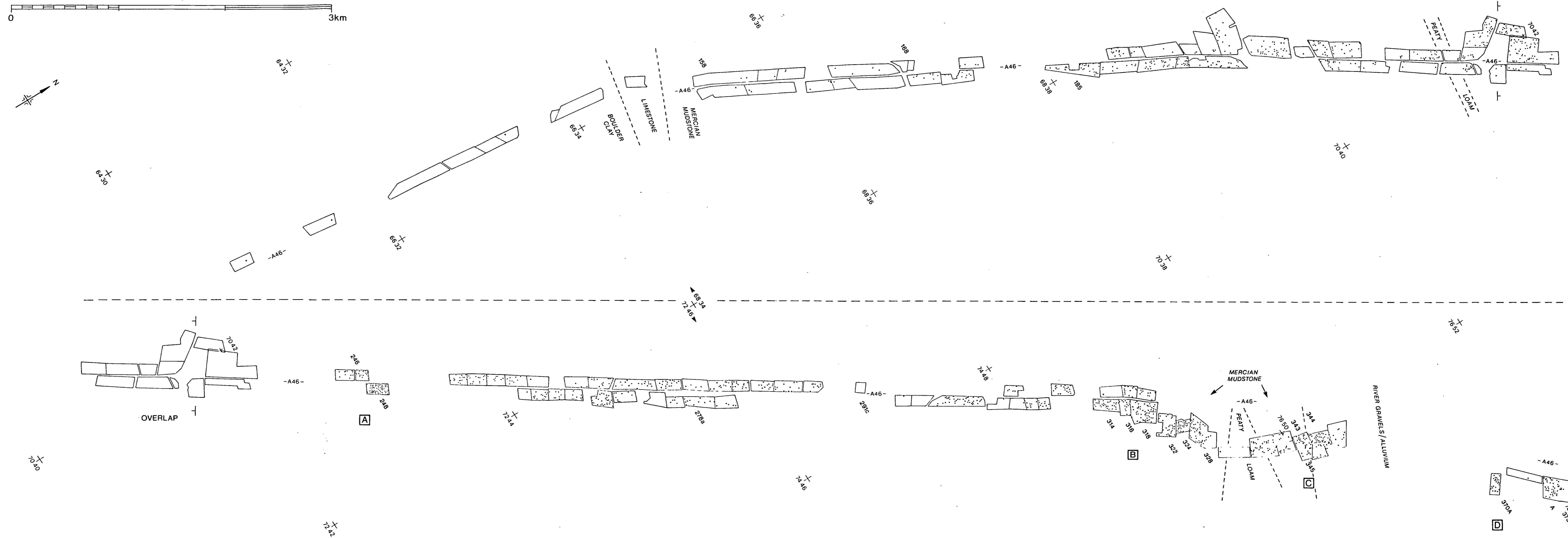

Figure 41. Distribution of medieval finds from fieldwalking.

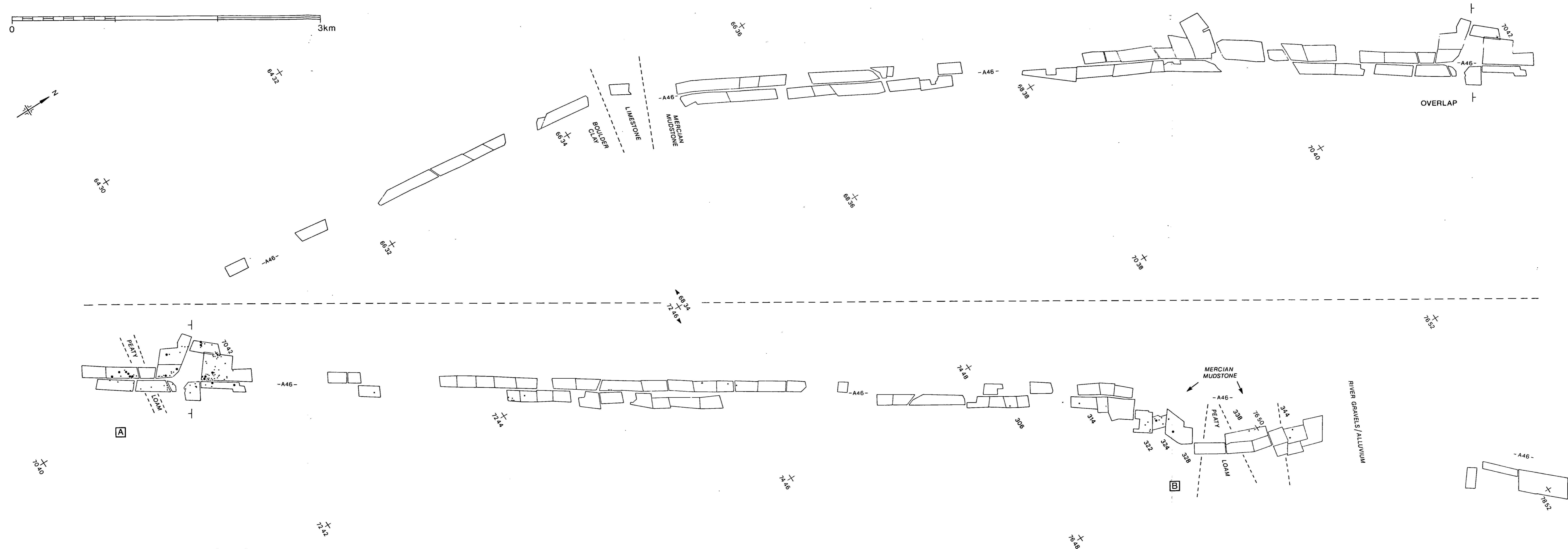

Figure 39. Distribution of Iron Age (large dots) and Iron Age/Anglo-Saxon pottery (small dots) from fieldwalking.

finds concentration

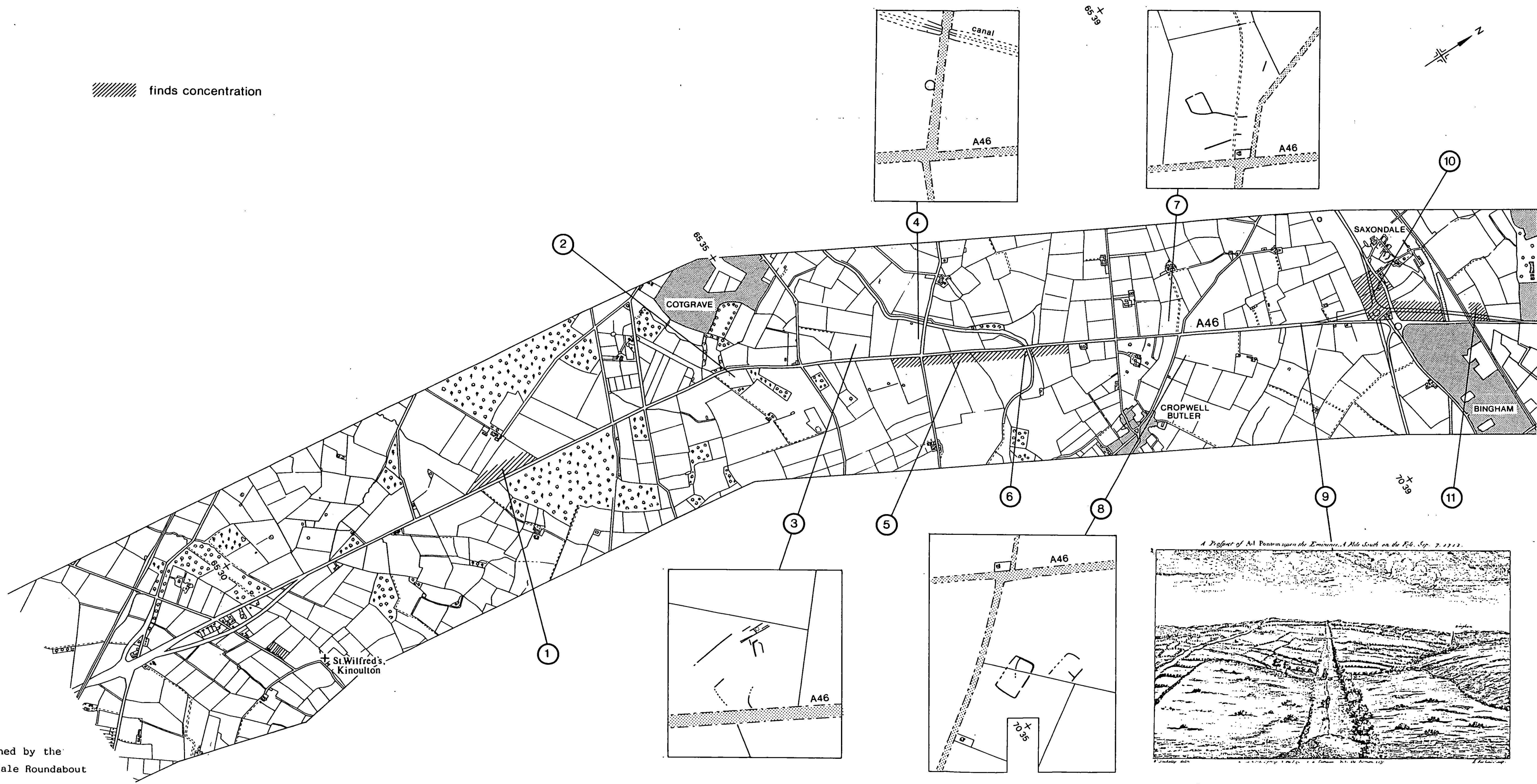
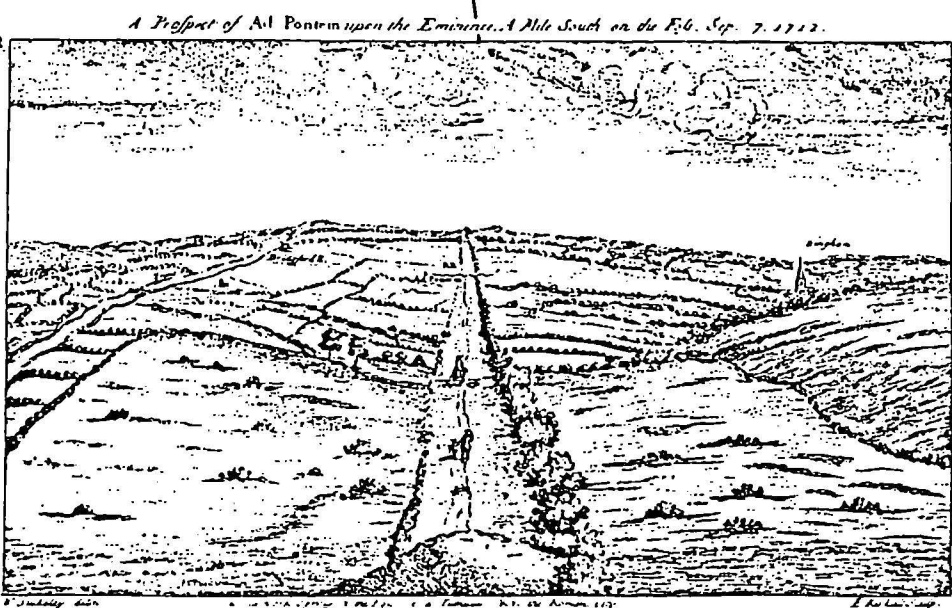
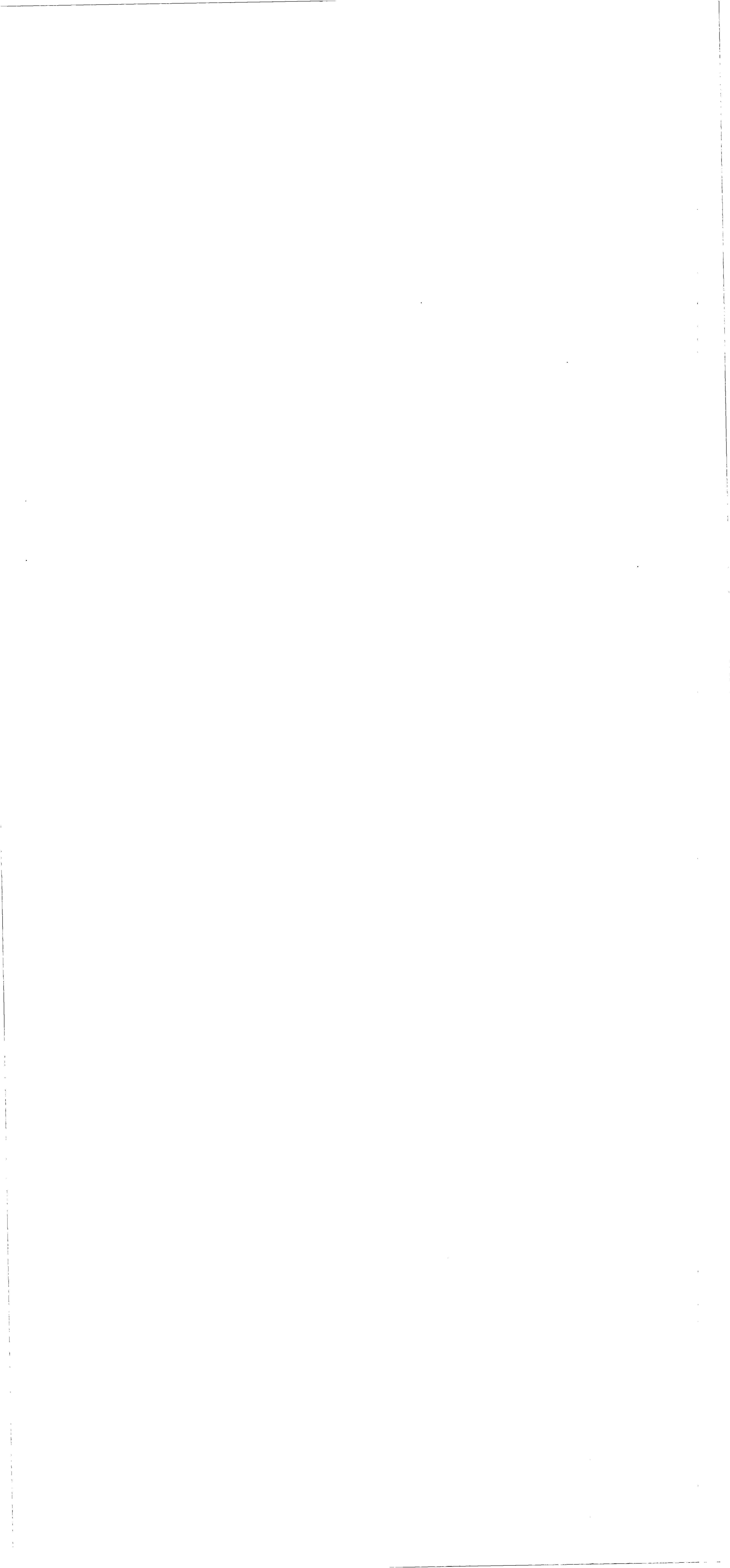

Figure 36. Principal sites threatened by the proposed road, Widmerpool to Saxondale Roundabout (sites 1-11).







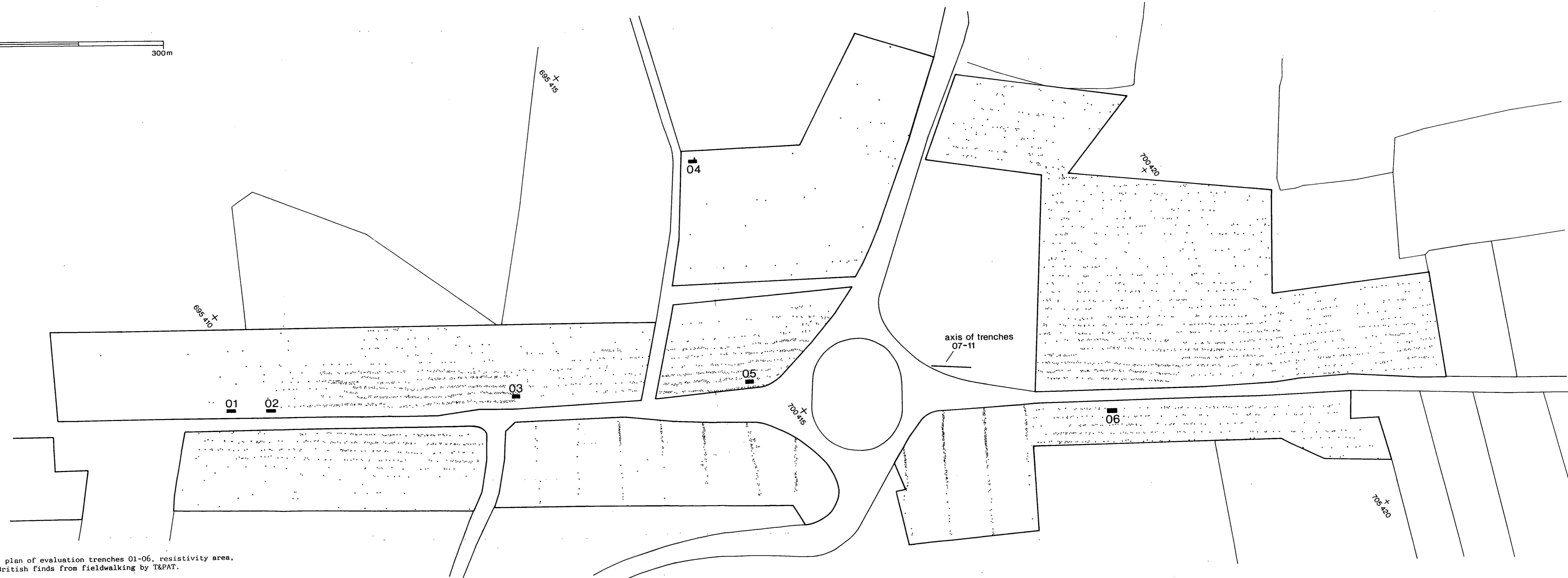
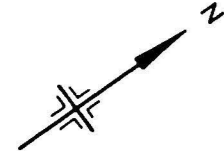
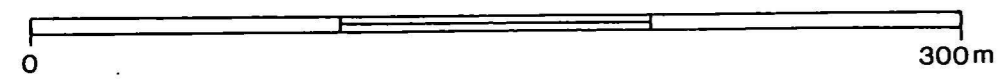

Figure 35. Margidunum: plan of evaluation trenches 01-06, resistivity area, and Romano-British finds from fieldwalking by T&PAT.