

**LAND AT HAROLD WOOD
HOSPITAL, GUBBINS LANE,
ROMFORD**

**AN ASSESSMENT OF AN
ARCHAEOLOGICAL FIELD
EVALUATION AND EXCAVATION**

**LOCAL PLANNING AUTHORITY:
LONDON BOROUGH OF HAVERING**

PCA REPORT NO: 11320

SITE CODES: HWP07 & GUB12

NOVEMBER 2015

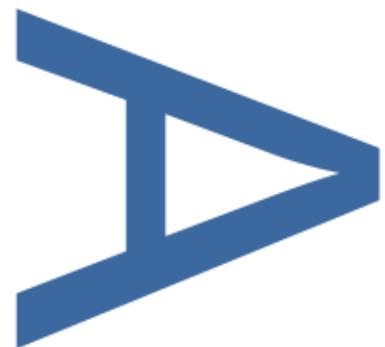

PRE-CONSTRUCT ARCHAEOLOGY

LAND AT HAROLD WOOD HOSPITAL, GUBBINS LANE, ROMFORD
AN ASSESSMENT OF AN ARCHAEOLOGICAL FIELD EVALUATION AND
EXCAVATION

SITE CODES: HWP07 AND GUB12

LOCAL PLANNING AUTHORITY: LONDON BOROUGH OF HAVERING

CENTRAL NGR: TQ 5420 9035

COMMISSIONING CLIENT: CGMS CONSULTING

on behalf of COUNTRYSIDE PROPERTIES LTD

WRITTEN BY: MARK BEASLEY

PROJECT MANAGER: CHRIS MAYO

POST-EXCAVATION MANAGER: DR FRANK MEDDENS

Contractor: **Pre-Construct Archaeology Limited**
Unit 54, Brockley Cross Business Centre
96 Endwell Road, Brockley
London, SE4 2PD

Tel: 020 7732 3925

Email: fmeddens@pre-construct.com

Website: www.pre-construct.com

© Pre-Construct Archaeology Limited
November 2012 / November 2015

© The material contained herein is and remains the sole property of Pre-Construct Archaeology Limited and is not for publication to third parties without prior consent. Whilst every effort has been made to provide detailed and accurate information, Pre-Construct Archaeology Limited cannot be held responsible for errors or inaccuracies herein contained.

Report number: R11320

CONTENTS

1	Abstract.....	4
2	The Background To The Project.....	7
2.1	<i>General Introduction</i>	7
2.2	<i>Site Location (Hwp07)</i>	11
2.3	<i>Planning Background</i>	11
2.4	<i>Methodology</i>	12
2.5	<i>Archaeological And Historical Background</i>	12
2.6	<i>Geology And Topography</i>	13
2.7	<i>Contents Of The Archives HWP07 & GUB12</i>	14
3	The Archaeological Sequence.....	15
3.1	<i>Introduction</i>	15
3.2	<i>Phase 1: Natural Deposits (Figures 4a, 4b)</i>	15
3.3	<i>Phase 2: Late Bronze Age To Early Iron Age Activity (Figures 5a, 5b, 5c)</i>	16
3.4	<i>Phase 3: Late Iron Age To Romano-British Field System (Figure 6a, 6b)</i>	20
3.5	<i>Phase 4: Continued Late Iron Age To Romano British Activity (Figure 7)</i>	32
3.6	<i>Phase 5: Post-Medieval Deposits (Figure 8a, 8b)</i>	36
4	Phase Summary.....	40
4.1	<i>Phase 1: Natural Deposits</i>	40
4.2	<i>Phase 2: Late Bronze Age/Early Iron Age Activity</i>	40
4.3	<i>Phase 3: Late Iron Age To Romano-British Field System</i>	41
4.4	<i>Phase 4: Late Iron Age To Romano British Activity</i>	42
4.5	<i>Phase 5: Post-Medieval Deposits</i>	42
5	Summary And Significance Of The Archaeological Sequence.....	43
6	Original Research Aims And Revised Research Aims.....	44
7	Recommendations For Further Work.....	46
8	Acknowledgements.....	47

APPENDICES

9	Appendix 1: Stratigraphic Matrices.....	48
10	Appendix 2: Context Index.....	54
11	Appendix 3: Prehistoric Pottery Assessment.....	73
12	Appendix 4: Lithics Assessment.....	75
13	Appendix 5: Environmental Report.....	80
14	Appendix 6: Harold Wood Ph Determination.....	83
15	Appendix 7: Assessment Of Fired Clay Objects.....	84
16	Appendix 8: Late Iron Age And Roman Pottery Assessment.....	86
17	Appendix 9: Animal Bone.....	90
18	Appendix 10: Human Bone Assessment.....	93
19	Appendix 11: Ceramic Building Material Assessment.....	95

20	Appendix 12: Clay Tobacco Pipe Assessment.....	99
21	Appendix 13: Oasis Form – HWP07.....	100
22	Appendix 14: Phase 2b Archaeological Strip, Map And Sample Investigation	102
22.1	<i>Introduction</i>	102
22.2	<i>Archaeological Methodology</i>	102
22.3	<i>Archaeological Sequence</i>	102
22.4	<i>Interpretation And Conclusions</i>	104
22.5	<i>Acknowledgements</i>	104
22.6	<i>Bibliography</i>	104
22.7	<i>Context Index</i>	106
22.8	<i>Site Matrix</i>	107
22.9	<i>Post-Roman Pottery Assessment</i>	107
22.10	<i>Glass Assessment</i>	108
22.11	<i>Flint Assessment</i>	109
22.12	<i>The Ceramic Building Material</i>	109
23	Appendix 15: OASIS Form – GUB12	114

ILLUSTRATIONS

Figure 1: Site Location	6
Figure 2: Trench Location	9
Figure 3: Evaluation Trenches Overlain On 2011-2012 Excavation Areas & Topography.....	10
Figure 4a: Natural Features Areas 1 & 2	21
Figure 4b: Natural Features Areas 3 & 5	22
Figure 5a: Phase 2; Areas 1 & 4 Late Bronze Age / Early Iron Age Features	23
Figure 5b: Phase 2; Areas 2 & 5 Late Bronze Age / Early Iron Age Features	24
Figure 5c: Phase 2; Area 3 Late Bronze Age / Early Iron Age Features	25
Figure 6 A: Phase 3; Areas 1 & 4 Late Iron Age / Romano British Features	29
Figure 6b: Phase 3; Areas 2 & 5 Late Iron Age / Romano British Features	30
Figure 7: Phase 4; Areas 1& 4 Late Iron Age / Romano British Features	35
Figure 8a: Phase 5; Areas 1 & 4 Post-Medieval Features.....	37
Figure 8b: Phase 5; Areas 2 & 5 Post-Medieval Features.....	38
Appendix 14, Figure 1: Trench Location	111
Appendix 14, Figure 2: Area A Plan And Section	112
Appendix 14, Figure 3: Area B Plan And Section	113

1 ABSTRACT

- 1.1 This report is an Assessment document of an Archaeological Excavation on land at Harold Wood Hospital, Gubbins Lane, Romford RM3 0BE in the London Borough of Havering. The investigations were undertaken as part of a planning condition placed upon the proposed residential redevelopment of the site.
- 1.2 The site was centred on National Grid Reference TQ 54309035 (Figure 1) and was allocated the site code HWP 07. Prior to the archaeological investigations, the land was occupied by buildings of the Harold Wood Hospital, which during the investigations were in the process of being demolished. The report details two phases of investigation to the south-west of the site. The first phase of excavations comprised three areas of strip, map and record conducted during June and July 2011, with a further two areas excavated during April and May 2012 to clarify and expand on the results of the previous work. A final phase of additional work completed between 7th and 18th of September 2015 on land forming part of Phase 2B of the redevelopment the results of which are detailed in Appendix 14. The latter is under the site code GUB 12 following on from the earlier evaluation completed on this part of the site and separately reported on in PCA report reference R11161 (Pooley 2012).
- 1.3 The project was commissioned by CgMs Consulting acting on behalf of their clients, Countryside Properties Ltd, who generously funded the field and post-excavation work. The archaeological fieldwork was monitored by Mr Adam Single and Laura O’Gorman of the Greater London Archaeological Advisory Service on behalf of the London Borough of Havering, Suzanne Gailey of CgMs on behalf of Countryside Properties Plc, and was undertaken by Pre-Construct Archaeology Ltd. The first phase was supervised by Neil Hawkins for PCA, and the second phase by the Mark Beasley and the final phase by Amelia Fairman. The project was managed for PCA by Chris Mayo.
- 1.4 The Archaeological work revealed features dating from the late Bronze Age to the late Iron Age and early Romano-British transition, thought to represent the remains of field systems and possible farmstead settlement, reflecting the changes to landscape use throughout this period. Four cremations of late Bronze Age to early Iron Age date, and a single cremation of late Iron Age to early Roman date were identified. This latter consisted of a single individual aged between 5 – 10 years old.
- 1.5 Finds recovered from the investigations comprised pottery of late Bronze Age to early Roman date consistent with short-lived low density domestic usage with activity peaking in the decades either side of the Roman conquest. Flint tools and burnt stone from the site also suggest later prehistoric and early Roman technologies and fragmentary remains of animal bone intimate that cattle were being kept for their meat.
- 1.6 The final phase of work found a heavily truncated pre-historic feature forming the continuation of a linear element previously identified. Its fills did not contribute any additional finds material or environmental data and a limited number of later post-medieval cuts were also located.
- 1.7 This Assessment Document includes an introduction to the site, its location, geology and topography, archaeological methodology and a summary of the historical and archaeological background. It also provides a statement on the contents of the resulting archive of Excavation, including paper records, finds and environmental data. A phased description of the chronology of the site and a summary is

included, based on an interim interpretation of the archive. It also incorporates a summary of the research questions that resulted from the Assessment. It adds in observations on the significance of the data, and a statement of recommendations for further work.

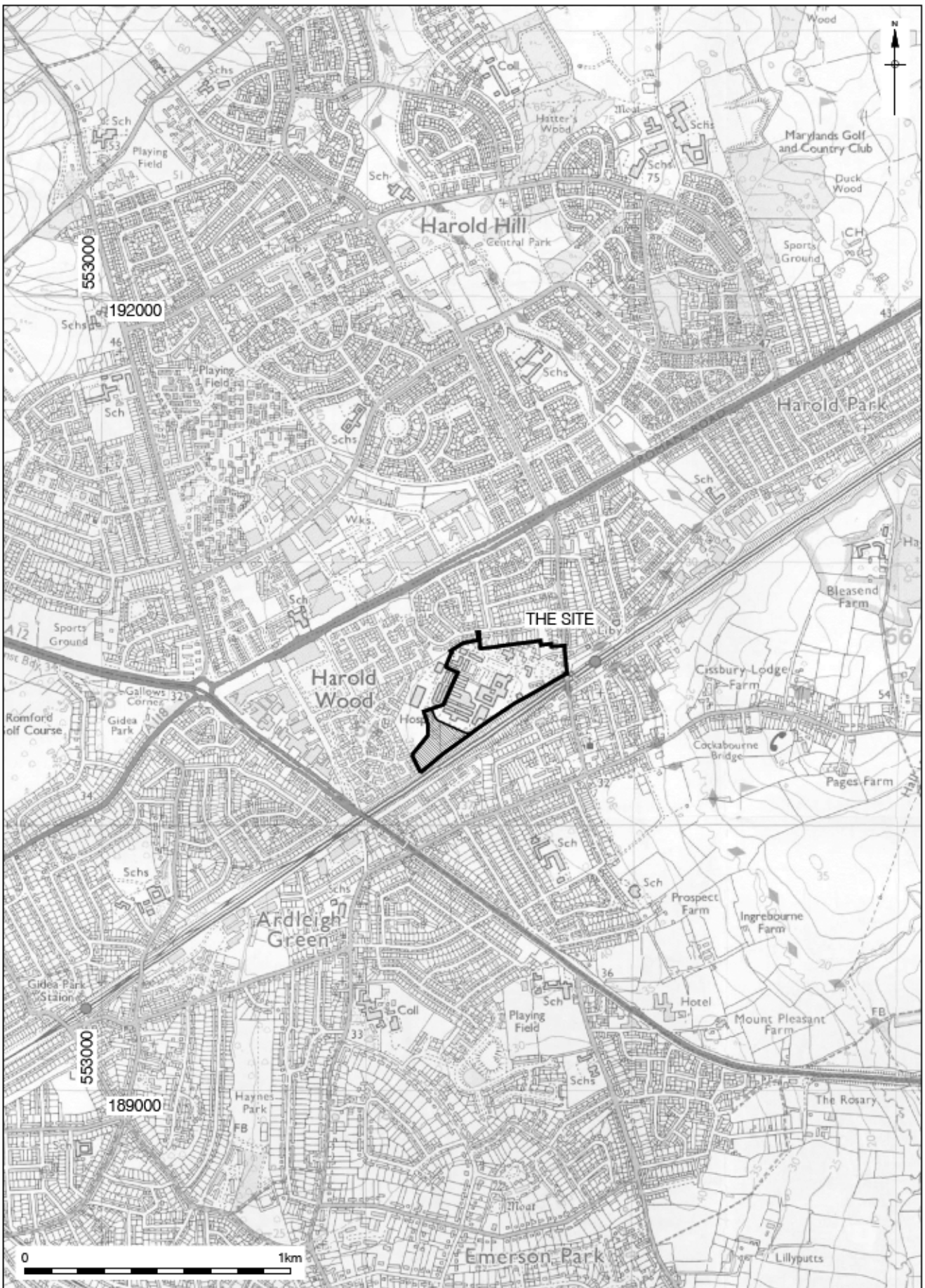

© Crown copyright 2006. All rights reserved. License number 36110309
 © Pre-Construct Archaeology Ltd 2012
 26/10/12 HB

Figure 1
 Site Location
 1:20,000 at A4

2 THE BACKGROUND TO THE PROJECT

2.1 General Introduction

- 2.1.1 A Desk Based Assessment of the site was prepared by CgMs Consulting (Gailey, 2006). This was followed by two phases of archaeological evaluation. The first of these was conducted in 2002 (Holden, 2002) and comprised 14 trenches (Figures 2, 3). Only one (Trench 14), close to the southern boundary, produced any significant archaeological remains in the form of features of Iron Age date which were recorded.
- 2.1.2 This was followed by a second evaluation conducted on the western side of the site during 2007 and 2008 (Seddon, 2008). This comprised of 14 trenches (Figure 2). Three of the trenches in the south-west (Trenches 2, 3 & 6) produced evidence for late prehistoric occupation in the form of pits, linear features, post holes and two probable cremations cut into natural clay. These were interpreted as relating to a small farmstead and cremation cemetery.
- 2.1.3 This was followed by the excavations reported in this document. The first phase of which consisted of five areas of excavation as defined by the WSI (Gailey, 2011), completed between June and July 2011 (HWP07). Areas 1, 2 and 3 measured 1,878m², 897m² and 464m² respectively. This was followed during April and May 2012 by the excavation of two additional sections, Areas 4 and 5, to clarify and expand on the results of the first phase of excavation. These measured 492m² and 652m² respectively.
- 2.1.4 This document provides a background to the investigations and includes a phased site summary with interim interpretations of the archaeological findings. It discusses the significance of these results including their ability to answer the research questions posed in the Written Scheme of Investigation and incorporates a summary of the research interests that came to light during the course of the Assessment. In some cases, these questions can be responded to by the data already available but in others, further analysis is required. It also includes a statement of recommendations for further work.
- 2.1.5 Further to the completion of the 2011 excavation (HWP07) a programme of evaluation and watching brief was undertaken in the east of the site (GUB12). The evaluation consisted of four trial trenches designed to investigate the archaeological potential of the site. The watching brief consisted of an area measuring 114m² excavated to the east end of Trench 1 in order to define and record a vaulted brick structure partially exposed during the evaluation. Within Trench 1, four 19th century brick structures were encountered, including a vaulted structure, initially interpreted as an ice-house or vaulted culvert, as well as a possible pond or moat feature. Deposits within Trench 2 had been totally truncated by previous activity. Trench 3 contained a linear feature, possibly a field or enclosure ditch, securely dated to the late second / early first millennia BC. Trench 4 contained only modern intrusions and services cutting through slightly landscaped natural deposits. The watching brief showed the brick structures recorded in Trench 1 to be a bridge with arched span plus associated abutments and wing walls.
- 2.1.6 This was followed by a subsequent excavation undertaken in September 2015 targeting trench 3 to determine the extent and survival of any prehistoric activity in this part of the site. The limited results of these investigations are reported in Appendix 14 of this document. The remainder of this document

will focus on the results of the 2011/2012 excavations.

- 2.1.7 The commissioning client for the work was CgMs Consulting, acting on behalf of their clients, Countryside properties Ltd. The Archaeological Excavation was monitored by Mr Adam Single of the Greater London Archaeological Advisory Service on behalf of the London Borough of Havering, Suzanne Gailey of CgMs on behalf of Countryside properties Ltd, and was undertaken by Pre-Construct Archaeology Ltd. under the direction of Chris Mayo. Areas 1 – 3 were supervised by Neil Hawkins of PCA while Areas 4 & 5 were supervised by the Mark Beasley. The 2012 evaluation was carried out under the supervision of Ashley Pooley under the site code GUB 12 and the final phase of work on this area was carried out by Amelia Fairman.

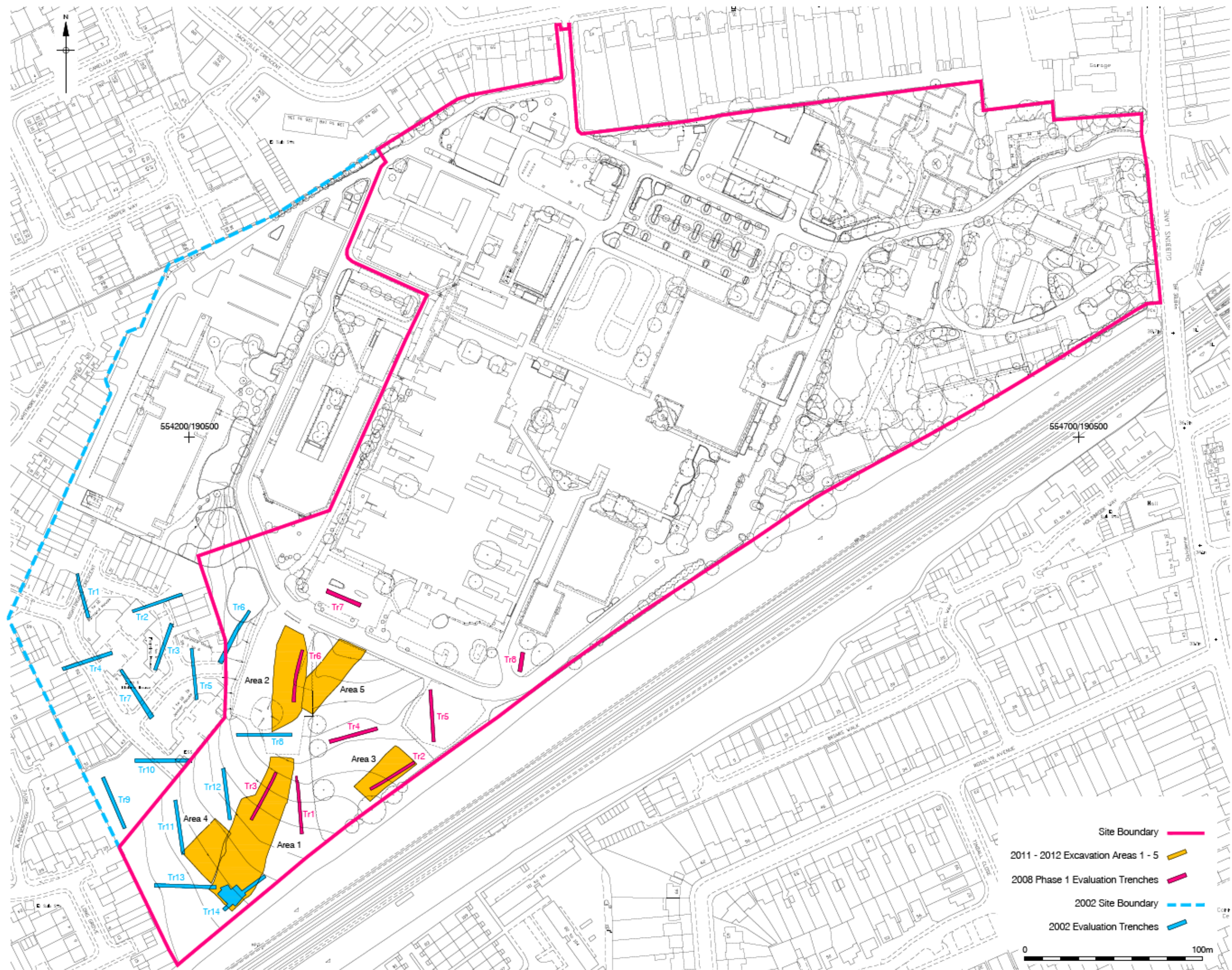

- Site Boundary —
- 2011 - 2012 Excavation Areas 1 - 5 ■
- 2008 Phase 1 Evaluation Trenches —
- 2002 Site Boundary - - -
- 2002 Evaluation Trenches —

0 100m

Figure 2
 Trench Location
 1:2,000 at A3

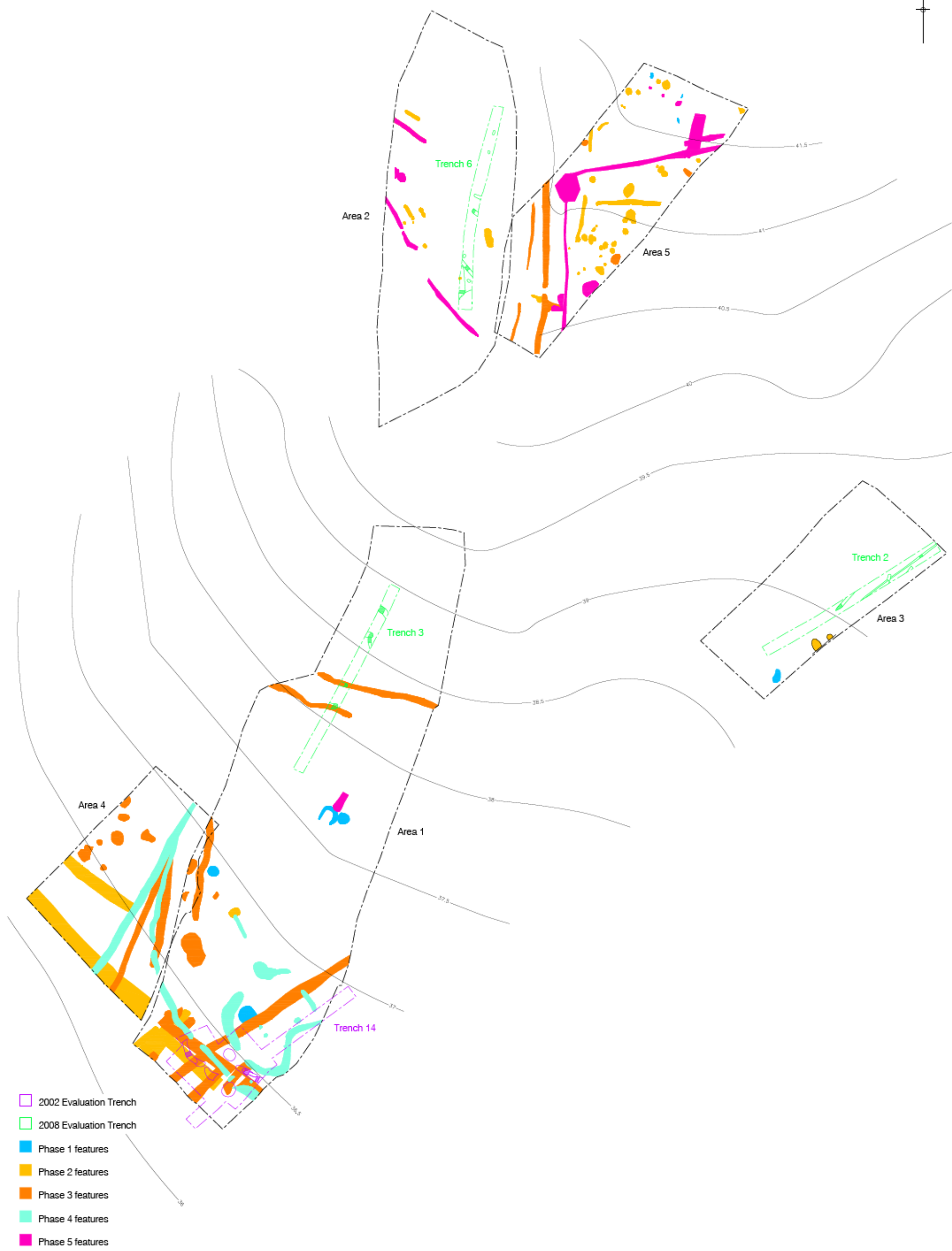

- 2002 Evaluation Trench
- 2008 Evaluation Trench
- Phase 1 features
- Phase 2 features
- Phase 3 features
- Phase 4 features
- Phase 5 features

-36.5- Contours in meters OD
0 20m

Figure 3
2002 & 2008 Evaluation Trenches overlain
onto 2011-2012 Excavation Areas & Topography
1:500 at A3

2.2 Site Location (HWP07)

2.2.1 The work was conducted on a block of land to the south-west of the former hospital buildings of Harold Wood Hospital (Figure 1). It is located to the northeast of Romford on the west facing slope of the Rom Valley, and to the edge of a ridge between the valleys of the Rom and Ingrebourne rivers.

2.2.2 The site consisted of a block of land to the south-west of the former hospital and comprised an area of fallow pasture with some mature trees to the east and scrub vegetation over the remainder (Figure 2). It was bounded to the south by the London to Southend mainline railway, to the west by new housing (evaluated in 2002) and to the north and east by the former hospital. A modern car park occupied the north end of Area 2 and a large bund of recent topsoil and rubble occupied the eastern end of Area 5.

2.2.3 The locale was broadly level at the north end and declined to the south and west before levelling out to the south of Areas 1 and 4.

2.3 Planning Background

2.3.1 The planning background to the site is covered in detail in the earlier desk-based assessment (Gailey, 2006), and is summarised below:

2.3.2 Government guidance provides a framework which:

- Protects Scheduled Ancient Monuments
- Protects the settings of these sites
- Protects nationally important un-scheduled ancient monuments
- Has a presumption in favour of in-situ preservation of important remains
- In appropriate circumstances seeks adequate information (from field evaluation) to enable informed decisions
- Provides for the excavation and investigation of sites not important enough to merit in-situ preservation

2.3.3 The relevant Development Plan framework is provided by the London Borough of Havering Unitary Development Plan (UDP) adopted in March 1993. The plan contains the following policy which provides a structure for the consideration of development proposals affecting archaeological and heritage features.

POLICY ENV14

WHEN ANY DEVELOPMENT IS PROPOSED THE COUNCIL WILL ENSURE THAT ANY ARCHAEOLOGICAL SIGNIFICANCE OF THE SITE IS EXAMINED AND EVALUATED. PLANNING PERMISSION WILL BE GIVEN WITHOUT ADEQUATE ASSESSMENT OF ANY ARCHAEOLOGICAL IMPLICATIONS. PLANNING PERMISSION WILL ONLY BE GRANTED WHERE SATISFACTORY PROVISION IS MADE IN APPROPRIATE CASES FOR THE PRESERVATION IN SITU, WHERE POSSIBLE, OR THE EXCAVATION AND RECORDING OF

ARCHAEOLOGICAL REMAINS. THE COUNCIL MAY REFUSE PLANNING PERMISSION FOR DEVELOPMENT ON SITES OF OUTSTANDING ARCHAEOLOGICAL SIGNIFICANCE.

2.3.4 The work was carried out in line with government policy, as set out in PPG16 and subsequent aspects of it were and are covered by Planning Policy Statement 5 (PPS5) 'Planning for the Historic Environment', and section - 12 'Conserving and Enhancing the Historic Environment', of the National Planning Policy Framework.

2.4 Methodology

2.4.1 The Archaeological Excavation consisted of the initial stripping of three areas of excavation, followed by two further sections to clarify the previous results. These excavations were carried out following methodologies detailed in the Written Scheme of Investigation (WSI) (Gailey, 2011) and the Health and Safety Method Statement (Mayo, 2012).

2.4.2 Initial ground reduction to remove modern topsoil and underlying subsoil was carried out with a 360° tracked excavator. All exposed surfaces were then cleaned using appropriate hand tools. Further excavation, to investigate archaeological features and deposits, was carried out using suitable hand tools, according to the policies detailed in the WSI.

2.4.3 Representative sections were drawn at a scale of 1:10, and outline trench plans made at a scale of 1:20. All features or deposits observed were recorded onto pro-forma context record sheets and planned at a scale of 1:20. All drawn sections were photographed and a general photographic survey of the site and working conditions was undertaken. Photographic coverage employed black and white print, colour print, colour transparency and digital formats.

2.4.4 All levels relate to the Ordnance Datum at Newlyn. Temporary benchmarks were established at the site using GPS.

2.4.5 Following the anticipated publication of the results of the investigations, the completed archive, comprising written, drawn and photographic records as well as artefacts recovered during the Evaluation and Excavation, will be deposited at the LAARC of the Museum of London, under the site codes HWP 07 & GUB 12.

2.5 Archaeological and Historical Background

The following information is summarised from the Desk-Based Assessment which preceded the field investigations (Gailey, 2006)

Palaeolithic, Mesolithic and Neolithic

2.5.1 No finds from the early prehistoric periods are recorded within 1.5km of the site, and the potential for these periods was considered to be low.

Bronze Age and Iron Age

2.5.2 A single site with remains dating to this period was recorded at Spilsby Road, about 500m north of the site. Here four small pits were recorded, one of which contained sherds of flint tempered late Prehistoric pottery and a fragment of burnt flint.

2.5.3 The potential for remains of Bronze and Iron Age date was considered moderate to high.

Roman

2.5.4 The London to Colchester Roman road is believed to lie directly under the modern A12 Colchester Road, some 450m north of the site. A Roman roadside cemetery was uncovered in 1839, including at least four cremation burials, at Whitelands Way approximately 500m north-west of the site. Roman pottery within a post-Roman ploughsoil was recovered from along Spilsby Road.

2.5.5 The potential for remains of this period was appraised as being moderate to high.

Anglo-Saxon, Medieval and Post-Medieval

2.5.6 It is thought that during the Saxon and Medieval periods the site lay within agricultural land, and that the potential for remains of these periods was low.

2.5.7 The first mention of activity on the site itself comes from 1507, when the tenement of 'Gobyons' is mentioned. This house is thought to have stood on the site of The Grange, a listed building from 1884 that currently stands and was, until recently the administrative block for the hospital. By 1594 'Gobyons' – or Gubbins – had been developed into a large manor which is present on Norden's County map. In 1670 the house was occupied by John Grosvenor, and was assessed for tax as having sixteen hearths. The house appears to have been demolished by the early 18th century.

2.5.8 Between the early 18th century and 1883 the site of the manor house was occupied by a single farm, shown on Chapman and Andre's map of 1777 and the Hornchurch Enclosure map of 1812.

2.5.9 The Grange was built in 1884, and is shown on the Ordnance Survey of 1898 as having inner gardens, orchards and agricultural land extending to some 30 acres (12.15 ha), with ancillary buildings along the Gubbins Lane frontage.

2.5.10 In 1908, The Grange was purchased as an annexe to the Plaistow Fever Hospital, and a ward built at right angles to the main building. The Grange remained unchanged until the 1930's when it was upgraded to full hospital status and four new ward blocks built to the west. Further expansion of the hospital occurred during the war of 1939-45 when hutted wards, theatres, x-ray and pathology laboratories were built over slab foundations to the south-west of The Grange. These buildings were replaced and further structures added to the north-eastern boundary of the site by the late 1960's, with the western side of the area remaining as agricultural land. During the 1970's, further buildings, landscaping and car parks were added to the western side of the site, but the excavation areas remained undeveloped throughout the lifetime of the hospital, although land divisions are thought to have been present.

2.6 Geology and Topography

2.6.1 The site is identified by the British Geological Survey (1996) as being situated on Black Park Gravel capping London Clay. A comprehensive geotechnical survey in 2001 (Gailey, 2006) described the drift geology as being glacial (fluvial) deposits comprising yellow brown and brown clays with occasional coarse gravel overlying London Clay

2.6.2 The northern part of the site lies at c. 40m OD, and declines gently to the south and west to around

35m OD.

2.7 Contents of the Archives HWP 07 & GUB 12

The Paper Record

Context Sheets	405
Sample Record Sheets	19
Plans (5m2):	166
Sections	114

Finds

Struck Flint and Burnt Flint	1 box
Prehistoric Pottery	1 box
Post-Medieval Pottery	2 boxes
Post-Medieval Glass	1 box
Ceramic building material	2 boxes
Animal Bone	1 box

3 THE ARCHAEOLOGICAL SEQUENCE

3.1 Introduction

3.1.1 This section presents the archaeological sequence at the site by considering the stratigraphical sequences of the evaluation trenches and excavation areas as an integrated whole. Individual Trench sequences are presented in the stratigraphic matrix (see Appendix 1) with descriptions and interpretations of the individual features and depositional layers given in the text below and in the context descriptions (Appendix 2). Cut numbers are presented in the text in square parentheses, with fills and layers in round parentheses. Ditches and other features with more than one excavated section are presented with a single cut number and separate equated fill numbers for each excavated section.

3.2 Phase 1: Natural Deposits (Figures 4a, 4b)

3.2.1 Natural deposits were observed in all evaluation trenches and excavation areas. The natural geology over the site consisted of firm orange brown glacial clay (Table 1) consistent with that described in the geotechnical survey. Toward the top of the slope, in Areas 2 and 5, spreads of coarse sandy flint gravel were present within the glacial clays.

3.2.2 In Area 1 the natural deposits consisted of mid-orange brown silt clay (103) ranging from 38.33m OD at the north of the trench to 35.92m OD at the south. An area of yellow brown silt clay (208), interpreted as a possible area of subsoil was recorded to the south of Area 1. The same natural mid-orange brown silty clay, [292], was recorded in Area 4, declining from north to south and ranging in elevation from 36.48m OD in the north to 35.69m OD to the south. Similar mid-orange brown silty clay (275) was recorded in Area 3.

3.2.3 In Areas 2 and 5, at the top of the slope, the mid-orange brown natural silt clay [290] contained lenses and spreads of coarse sandy flint gravel at the upper surface, primarily to the north of the areas. This again declined from north-east to south-west and lay at between 41.10m OD and 40.06m OD in Area 5 and 40.49m OD and 39.52m OD.

3.2.4 Four natural features were recorded in the surface of the natural clay in Area 1. To the west of this section, feature [252] was a sub-circular cut with irregular sides and a flat base, filled with light grey brown silt clay (251) and measuring 1.64m x 1.46m x 0.16m. To the south, a truncated element [266] was recorded. This consisted of a circular feature with straight sides and a flat base filled with mottled yellow brown silt clay (265), and measuring 2.72m x 2.48m x 0.40m depth. Toward the east of Area 1, cut [260] comprised a circular cut with concave sides and a flat base. This measured 1.80m x 1.64m x 0.36m deep, and was filled with mid-yellow brown silt clay (259). A curvilinear feature with concave sides and an irregular base [262] was recorded to the east of this. It measured 2.64m x 0.70m x 0.10m depth, was filled with a dark orange brown silt clay (261), and has been interpreted as a probable tree throw.

3.2.5 A single natural feature was recorded in Area 3 toward the south-west of the trench. This consisted of an irregular concave element [215] measuring 2.20m x 1.10m x 0.10m deep, and filled with a light orange yellow silt clay (214).

3.2.6 In addition to spreads and lenses of gravel, the natural clay in Area 5 contained localised deposits of

fractured stone. These were recorded as shallow amorphous cuts [336], [371] and [402] containing fills of fractured medium-sized stone within a yellow brown silty clay matrix; (335), (370) and (401) respectively. These measured between 0.80m x 0.40m and 0.46m x 0.14m and had a maximum depth of 0.20m and were initially thought to be possible post-pads, but the unstructured nature of the stone and the depth would suggest rather that they represent deposits of natural stone within the glacial clay.

Context	Trench	Interpretation	Description	Upper Height	Lower Height
103	Area 1	Natural	Mid orange brown silt clay	38.33m OD	35.92 m OD
158	Area 2	Natural	Mid orange brown silt clay with coarse sandy flint gravel	40.49 m OD	39.52 m OD
275	Area 3	Natural	Mid orange brown silt clay	--	--
292	Area 4	Natural	Mid orange brown silt clay with coarse sandy flint gravel	41.10 m OD	40.06 m OD
290	Area 5	Natural	Mid orange brown silt clay	36.48 m OD	35.69 m OD

Table 1: Summary of levels on natural deposits

3.3 Phase 2: Late Bronze Age to Early Iron Age Activity (Figures 5a, 5b, 5c)

- 3.3.1 A number of features of probable derived from the late Bronze Age to early Iron Age, based on the date of pottery recovered from their fills. These were recorded in Areas 1, 2, 3, 4 and 5. Features in Area 2 are attributed to this phase on the basis of the presence of un-diagnostic prehistoric pottery in a single fills, while those in Area 3 are credited on the basis of a single sherd of Late Bronze Age or early Iron Age (LBA/EIA) pottery. Those in Area 4 were undated, and the separation of these features into this phase is based on the stratigraphic relationships, and their continuation into Area 1.
- 3.3.2 In Area 1, three intercutting ditches were recorded on the south side of the area. Ditch [102] had a concave profiled cut measuring 4.02m x 0.85m x 0.45m deep with a primary fill of pale brown pink clay (101) overlain by pale grey clay (100). Three sherds of medium-to-coarse flint tempered pottery of late Bronze Age to early Iron Age (LBA/EIA) date (Appendix 3) were recovered from fill (100). The feature was aligned north-east to south-west, terminating to the north, and cut a larger linear feature on the same alignment, [207]. This measured 8.70m x 2.40m x 0.50m depth, and was filled with a single fill recorded as a mid-brown orange silt clay (206) = (249) to the north of the feature and as light grey brown silt clay (226) in the southernmost excavated section. The distal end of a prismatic blade, possibly a failed attempt at micro-burin or microlith production, was recovered from fill (249). This is probably of Mesolithic date and is therefore probably residual in this context (Appendix 4).
- 3.3.3 This in turn cut a north-west to south-east aligned ditch [223]; postulated to extend from the excavated sections to the western and eastern limits of excavation. It measured 10.55m x 1.20m x 0.60m deep, and held a single fill of mid-brown orange silt clay (222) = (235).
- 3.3.4 To the north of these features, a small pit [239], sub-circular and concave toward the western limit of excavation. Its fill was a mid-reddish brown grey silt clay (238) and it measured 1.70m x 1.20m x 0.38m depth. It included a single sherd of medium flint tempered pottery dated to the LBA/EIA.
- 3.3.5 In Area 4 a ditch was found on the south side of the area, aligned north-west to south-east, and passing into section to the north-west and south. It consisted of a concave linear cut [461], with a single fill of mid-yellow brown silt clay (460), measuring 25m in length, 1.45m wide and 0.54m deep. This feature

continued through to the east into Area 1 as ditch [223].

- 3.3.6 Parallel to this, on its north side, a second ditch [464] comprised a linear concave cut measuring 12.60m in length by 1.80m wide with a maximum depth of 0.50m. This was filled with a light grey yellow brown silt clay. The upper fill, was between 0.15m – 0.20m thick with blue grey mottles (462) = (465). This overlay a primary fill of mid-yellow brown silt clay (463) = (466), representing re-deposited natural clay. This ditch is likely to terminate to the south-east, but its probable butt-end was obscured by truncation by later features.
- 3.3.7 To the north of Area 2, a short gully or elongated ovoid pit [210] was aligned north-west to south-east and measured 2.50m x 0.50m x 0.15m deep. This was filled with mid-brown grey silt clay (211). To the south of this was a cluster of six small pits or post-holes. Cuts [164], measuring 0.80m x 0.43m x 0.08m depth, and [166], measuring 0.68m x 0.55m x 0.08m depth were adjoining ovoid and concave filled with pale grey silt clay (163) and (165) respectively. To the west of these a small circular cut [170] with concave sides to a flat base measured 0.41m diameter x 0.06m depth and was filled with pale grey silt (169). To the south of this was a small sub-circular pit or post-hole [168]. This measured 0.45m x 0.36m x 0.06m depth and was filled with a similar pale grey silt clay (167) from which a decortication flake and a single small fragment of burnt flint were recovered.
- 3.3.8 Further to the west was a further similar sub-circular cut [172] measuring 0.40m x 0.35m x 0.06m in depth which was filled with a pale grey silt clay (171). The sixth pit in the group, [176], lay to the south of those described above and was circular and concave measuring 0.66m x 0.54m x 0.13m in depth and was filled with mid-grey silt clay (175).
- 3.3.9 Associated with these six elements was an elongated pit [174], similar to [210], which was aligned north-west to south-east and which measured 2.0m x 0.46m x 0.10m in depth. This was filled with mid-grey silt clay (173).
- 3.3.10 A single isolated post-hole or small pit [178] was recorded to the south-east of these features. It consisted of a sub-circular concave cut measuring 0.46m x 0.34m x 0.09m in depth, with a fill of mid-grey silt clay (177).
- 3.3.11 To the east was a sub-rectangular pit [200] with concave sides and an irregular base, aligned north to south and measuring 2.74m x 1.0m x 0.13m in depth. Its single pale grey silt clay fill (199) contained two sherds of flint tempered pottery broadly dated to the prehistoric period, two squat flint flakes and three fragments of burnt flint. This was cut to the south by a small sub-circular concave element [185]. This measured 0.52m x 0.38m x 0.10m deep and was filled with dark grey silt clay and charcoal (184). This is thought to represent a cremation, and analysis of soil residues from this context indicate the presence of small quantities of un-diagnostic burnt bone (Appendix 5). This supports the notion of it being a cremation, but medium to strong soil acidity (Appendix 6) has resulted in the non-preservation of identifiable bone elements.
- 3.3.12 In Area 3, two features have been provisionally attributed to this phase. Cut [217] consisted of a sub-ovoid concave element passing into the southern limit of excavation, and filled with light orange yellow silt clay (216). This measured 1.50m x 1.20m x 0.30m in depth, and may represent either an ovoid pit or the terminal of a linear feature. Five sherds of flint tempered pottery dating to the LBA/EIA were

recovered from (216).

- 3.3.13 To the east, and again passing into the southern limit of excavation, a similar feature [221] was excavated. This was filled with light orange yellow silt clay (220), and may also represent either an ovoid pit or the terminal of a linear feature.
- 3.3.14 The most numerous remains ascribed to this phase pertained to Area 5. Five probable natural features are included in this phase on the basis of the nature of their fills; differentiating them from the re-deposited natural clay filling the natural features in Phase 1. A group of small intercutting features [384], [386] and [388], were interpreted as root holes, and were located to the north-west of Area 5. These measured 0.24m x 0.24m x 0.05m deep, 0.22m x 0.22m x 0.05m deep and 0.20m x 0.20m x 0.11m deep respectively. All were filled with brown grey silt clay (383), (385) and (387). Context [388] apparently cut (385). To the south of these features, a short irregular linear element [346] was filled with yellow brown silt clay (345). This measured 1.80m x 0.36m x 0.14m deep with irregular concave sides and a concave base. It has been interpreted as a root hole. To the south of Area 5, a small sub-circular cut [396], measuring 0.20m x 0.16m x 0.10m deep, was filled with mid grey brown silt clay, (395). This has again been interpreted as a tree root.
- 3.3.15 Three linears recorded across Area 5 may represent small sections of enclosure ditches. Ditch [353] had a concave-profile measuring 6.68m by 0.56m maximum width and a 0.12m depth, and terminated to north and south in rounded butt-ends. This was filled with yellowish dark brown silt clay (297) = (298) = (352). A single piece of heavily burnt flint was recovered from fill (352). Fill (352) was cut by a small possible posthole or small pit [351]. This consisted of a sub-circular cut measuring 0.30m x 0.25m and was 0.08m deep, filled with light brown silt clay (350). To the north of these, ditch [304] had a linear concave-profile filled with yellowish brown silt clay (303). This measured 3.2m x 0.40m wide and was 0.15m deep, terminating to the south in a rounded butt-end and passing into section to the north. Three sherds of a flint tempered post Deverel-Rimbury closed-mouthed shouldered jar dated to the LBA/EIA were retrieved its fill (303).
- 3.3.16 Running perpendicular to the west of the northern end of ditch [353], ditch [392] was east west aligned with a concave profile that measured 9.12m by 0.60m wide and 0.20m in depth, terminating to the west in a rounded butt-end and passing into section to the east. This was filled with greyish light brown silt clay (391) = (413) = (414). A single sherd of LBA/EIA flint tempered pottery was recovered from (391).
- 3.3.17 The remaining features in Area 5 consisted of a number of pits located across the trench. A group of seventeen small pits and a possible post holes were excavated on the east side of Area 5 in the area defined by the right-angle formed by ditches [353] and [392]. All were sub-circular concave-profiled cuts of broadly similar dimensions. Pits [319] and [340] measured 0.60m x 0.60m x 0.10m deep, and 0.80m x 0.70m x 0.20m deep respectively. They were filled with, mottled mid-orange grey silt clay (318) and mottled mid brown grey silt clay (339). Six sherds of LBA/EIA flint tempered pottery were recovered from fill (318).
- 3.3.18 Pits [310] and [286] were situated to the north of these and measured 0.80 x 0.70m x 0.20m deep and 0.90m x 0.70m x 0.20m deep respectively. They were filled with mottled mid-orange brown grey silt

clay (309) and mottled light brown grey silt clay (285). A single piece of heavily burnt flint came from fill (285) and another from (309). To the north of this a larger and deeper pit [329] was filled with light blue grey sandy clay (328) from which a single sherd of LBA/EIA medium flint tempered pottery was recovered. It measured 1.56m x 1.30m x 0.43m deep, and cut two smaller, shallower, features [331] and [333]. These measured 0.75m x 0.70m x 0.18m deep and 1.0m x 0.70m x 0.11m deep in that order, and were filled with mid-yellow grey sandy clay (330) and mid-red brown grey sandy clay (332).

- 3.3.19 Cuts [321], [306] and [308] lay to the west of pit [282]. These consisted of sub-circular concave elements measuring 0.60m x 0.60m x 0.15m deep, 0.90m x 0.70m x 0.15m deep and 0.50m x 0.50m x 0.10m deep in turn. They were filled with mid-orange brown grey silt clay (320), mottled light brown grey silt clay (305) and mottled light brown grey silt clay (307). Three sherds of LBA/EIA flint tempered pottery and a single piece of burnt flint was recovered from fill (305), and a further piece from (320).
- 3.3.20 Pits [355], [359], [361], [363] and [365] lay towards the southern terminus of ditch [353]. Pit [361] was sub-circular and concave and measured 0.61m x 0.60m x 0.08m deep and was filled with mid-brown silt clay (360) from which a sherd of LBA/EIA flint tempered pottery was recovered. It cut pit [359], a concave ovoid feature measuring 1.40m x 0.58m x 0.09m deep and filled with greyish mid-brown silt clay (358). To the west of this was [355] a circular concave pit of 0.84m x 0.82m x 0.14m deep filled with yellow brown silt clay (354). Pit [363] was ovoid and concave and measured 0.74m x 0.50m x 0.09m deep filled with yellow brown silt clay (362). Cut [365] was circular and concave and was filled with greyish brown silt clay (364), it measured 0.22m x 0.21m x 0.11m deep.
- 3.3.21 Cut [398] was smaller than the other features in this area and may represent the truncated remains of a posthole. It was a sub-circular cut measuring 0.32m x 0.26 x 0.22m deep and filled with dark grey brown silt (397).
- 3.3.22 In the same area three further elements were excavated that may represent degraded cremations. These consisted of [404], [357] and [377]; circular or sub-circular cuts with straight sides and flat bases measuring 0.36m x 0.31m x 0.18m deep, 0.38m x 0.28m x 0.14m deep and 0.88m x 0.65m x 0.14m deep respectively. They were filled with dark grey blue/black silt clay (403), (356) and (376). Twenty-seven sherds of flint tempered pottery of LBA/EIA date were recovered from the fill of [377], while 158 sherds came from (403). Feature [377] cut an underlying pit, [390]. This comprised a sub-circular cut measuring 1.22m x 1.15m x 0.31m deep, and was filled mid-yellow brown sandy clay (389).
- 3.3.23 None of these features yielded any traces of human – or other – bone, which again may be related to the acidity of the soils. The presence of relatively large numbers of pot sherds in two of the fills may indicate the presence of fragmented funerary vessels within them, supporting their interpretation as cremations. Alternatively, though considered less likely, these features may represent the bases of burnt-out posts or casual disposal of hearth rake-out.
- 3.3.24 To the north of ditch [392] a further five pits were recorded aligned along the length of [392]. Pit [327] was situated to the north of the west end of [392]. This consisted of a circular cut, measuring 0.90m x 0.83m x 0.36m deep, with straight sides and a flat base and was filled with light grey brown silt clay (326). To the east, pit [342] was sub-circular, measuring 2.00m x 1.50m x 0.55m deep with straight sides and a flat base, and was filled with a dark orange brown primary fill (349) below an upper fill of

dark brown silt clay (341). Ten pieces of variably burnt flint were recovered from (341), including angular shattered nodules, small pebbles with a piece of quartzite, and six sherds of flint tempered LBA/EIA pottery including a rim sherd of post Deverel-Rimbury with impressed fingerprint decoration.

- 3.3.25 To the east of this three cuts were recorded; [367], [369] and [416]. Pit [367] was circular and concave measuring 0.97m x 0.94m x 0.25m deep, and filled with yellow brown clay silt (366). This cut a slightly larger ovoid pit [369]; measuring 1.02m x 0.84m x 0.20m deep, this was filled with yellow light brown silt clay (368). To the north-west, [416] was smaller, measuring 0.38m x 0.26m x 0.10m deep and filled with grey brown silt clay (415). This may represent a small posthole.
- 3.3.26 Pit [412] was irregularly shaped and shallow with concave sides and a flat base. It was located to the south of the area. This measured 1.50m x 0.90m x 0.15m deep, and was filled with mid-grey brown clay silt (411). A sherd of flint tempered LBA/EIA pottery was came from (411).
- 3.3.27 A further five discrete features were identified to the north of Area 5. Cuts [314], [325], [373], [400] were located in the north-west corner of Area 5. Pit [314] was a sub-circular concave cut measuring 0.84m x 0.64m x 0.54m deep, filled with a firm dark grey brown silt clay primary fill [313] overlain by a yellow brown clay upper fill (315), from which two heavily burnt tertiary pebbles were recovered. To the east of this, [325] was sub-circular measuring 0.68m x 0.60m x 0.19m deep, and was filled with greyish brown silt clay (324). Five sherds of flint tempered pottery of LBA/EIA date and four fragments of variably burnt flint were recovered from (324). Pit [373], to the north-east of these, was a shallow concave sub-circular cut measuring 0.64m x 0.58m x 0.12m deep, and filled with grey brown silt clay (372). Adjacent to this, pit [400] measured 1.30m x 1.16m x 0.28m deep, and was filled with yellow brown clay (399).
- 3.3.28 Pit [312] was located in the north-eastern corner of the area and passed into section to the north and east. It measured 1.06m x 0.79m x 0.15m deep, and was filled with light yellow brown sandy clay and was truncated to the north by a modern water pipe [+].
- 3.3.29 Close to the eastern limit of excavation pit [302] was circular, measuring 0.60m x 0.54m x 0.20m deep and filled with grey brown silt clay (301). Six sherds of flint tempered pottery of LBA/EIA date were recovered from (301).

3.4 Phase 3: Late Iron Age to Romano-British Field System (Figure 6a, 6b)

- 3.4.1 The late prehistoric remains are the most numerous on the site, and are represented in Areas 1 and 4. Isolated features from this period were also identified in Area 5.

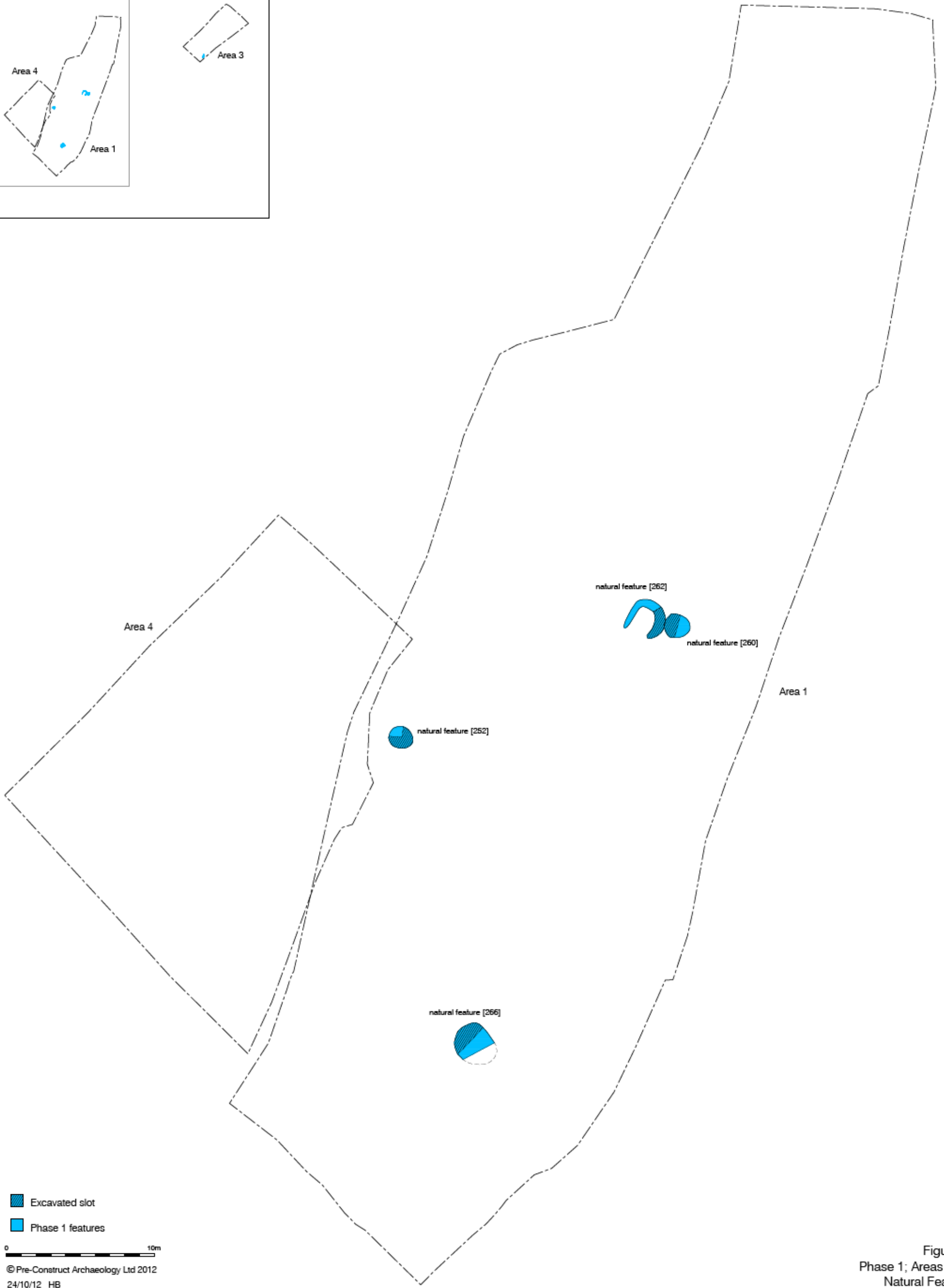
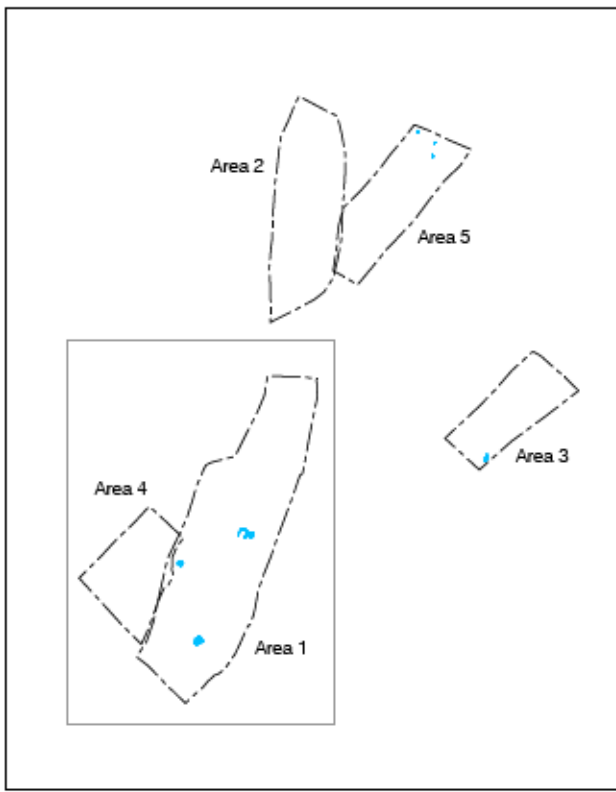

- Excavated slot
- Phase 1 features

0 10m

© Pre-Construct Archaeology Ltd 2012
24/10/12 HB

Figure 4a
Phase 1; Areas 1 & 4
Natural Features
1:250 at A3

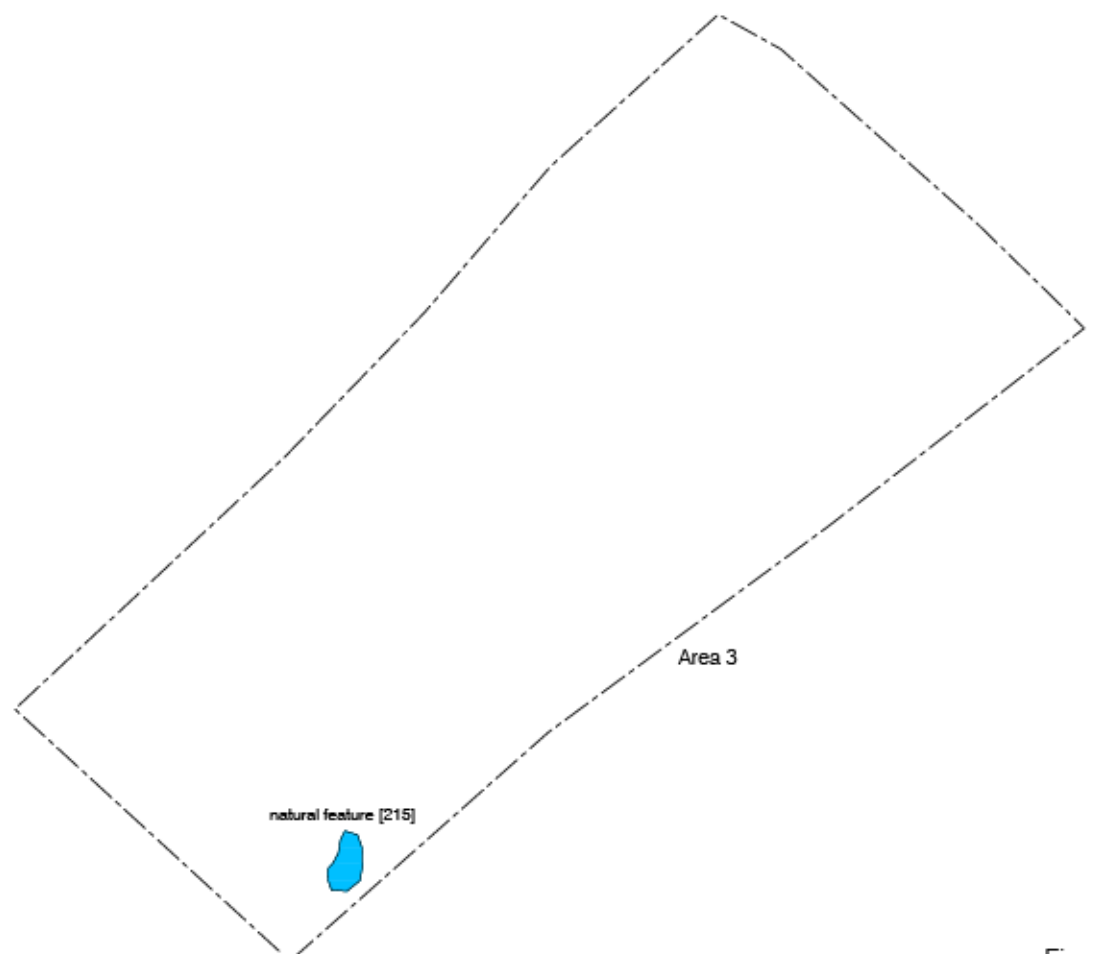
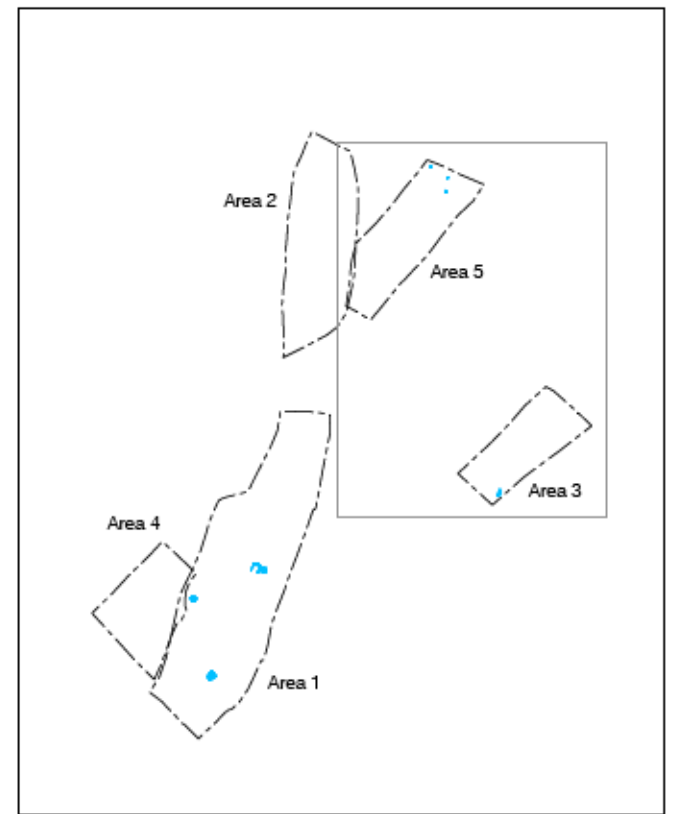
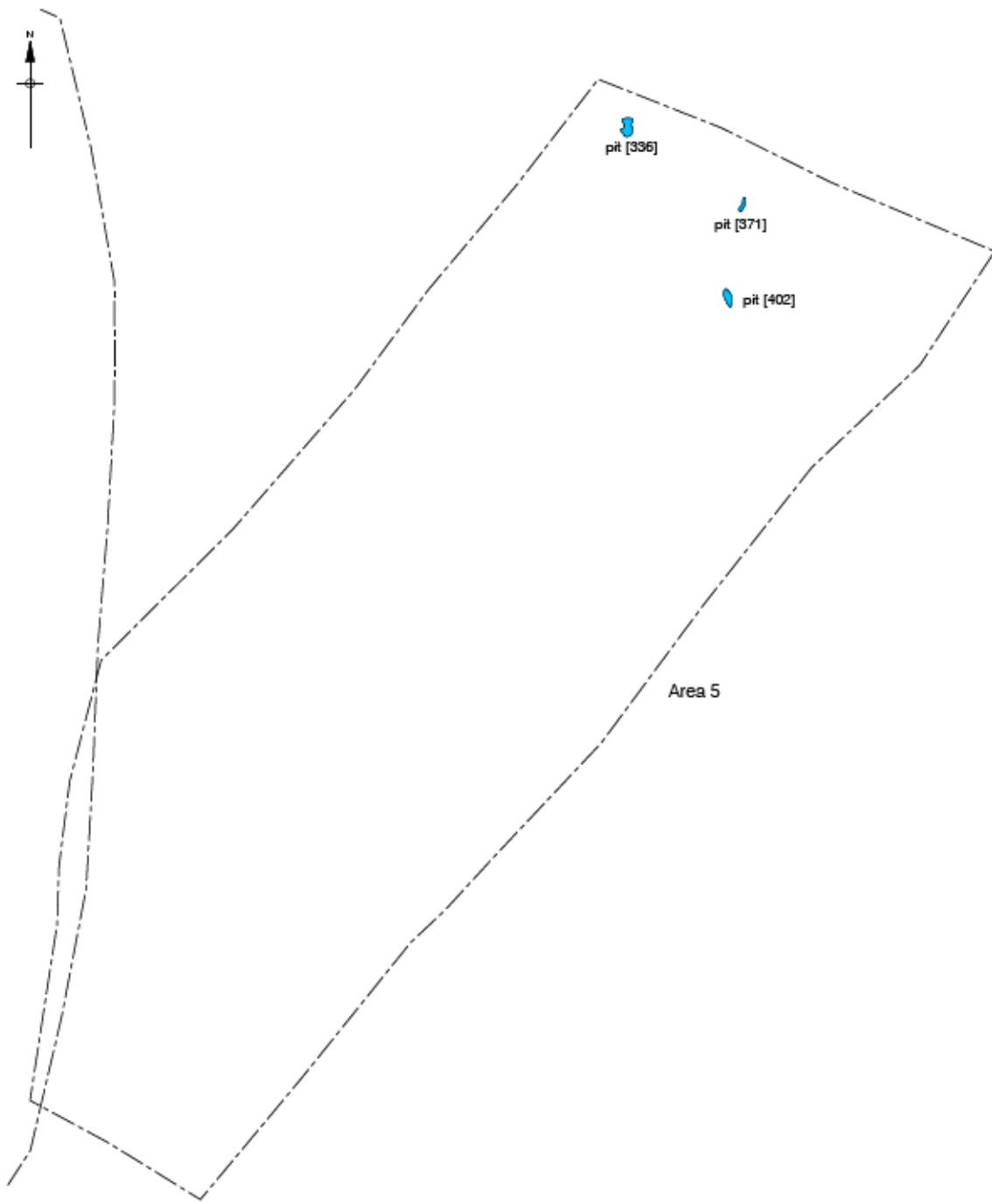

Phase 1 features

0 10m

© Pre-Construct Archaeology Ltd 2012
24/10/12 HB

Figure 4b
Phase 1; Areas 3 & 5
Natural Features
1:250 at A3

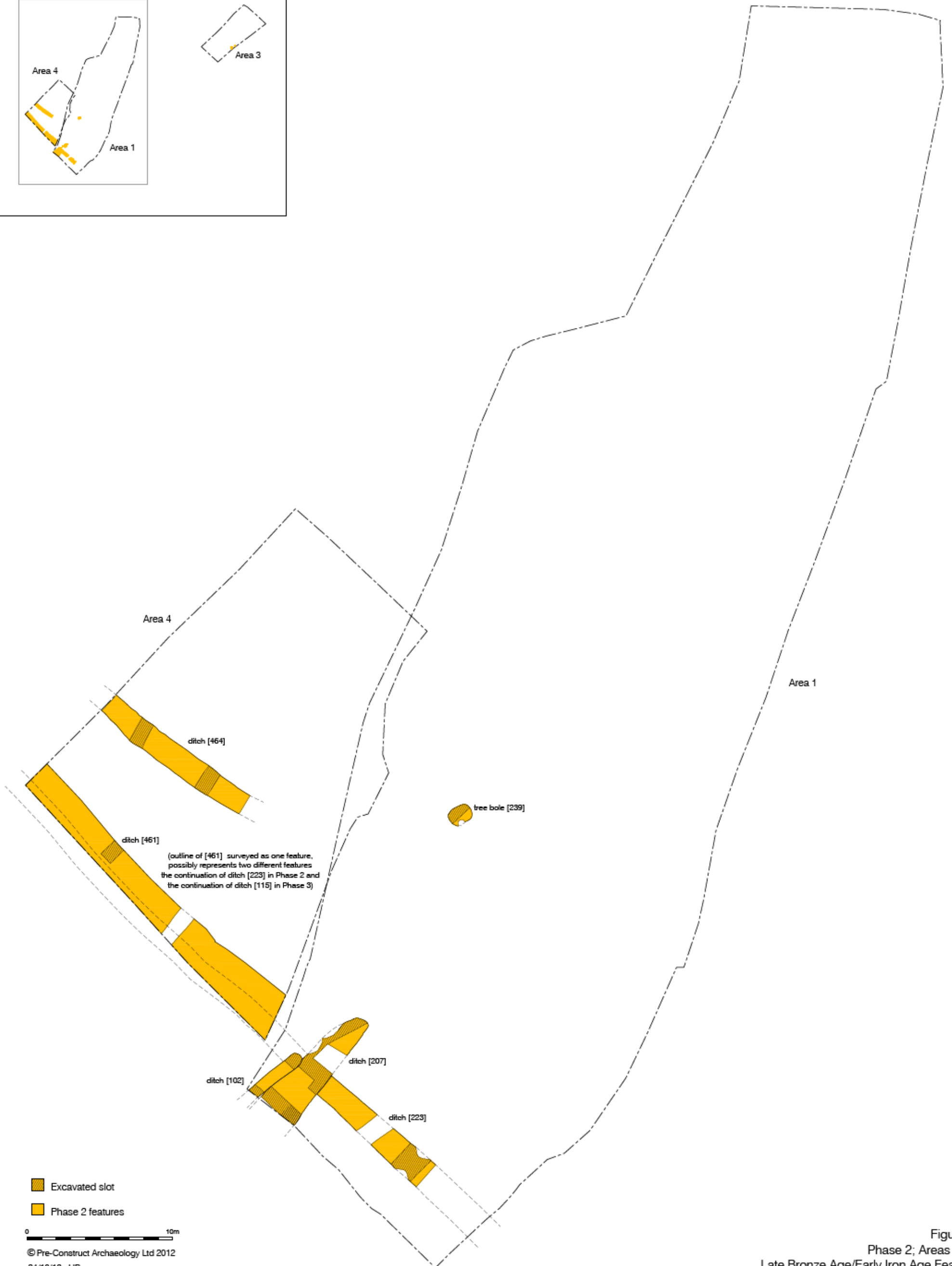



Figure 5a
 Phase 2; Areas 1 & 4
 Late Bronze Age/Early Iron Age Features
 1:250 at A3



-  Excavated slot
-  Phase 2 features

0 10m

Figure 5b
Phase 2; Areas 2 & 5
Late Bronze Age/Early Iron Age Features
1:250 at A3



Phase 2 features

0 10m

© Pre-Construct Archaeology Ltd 2012

24/10/12 HB

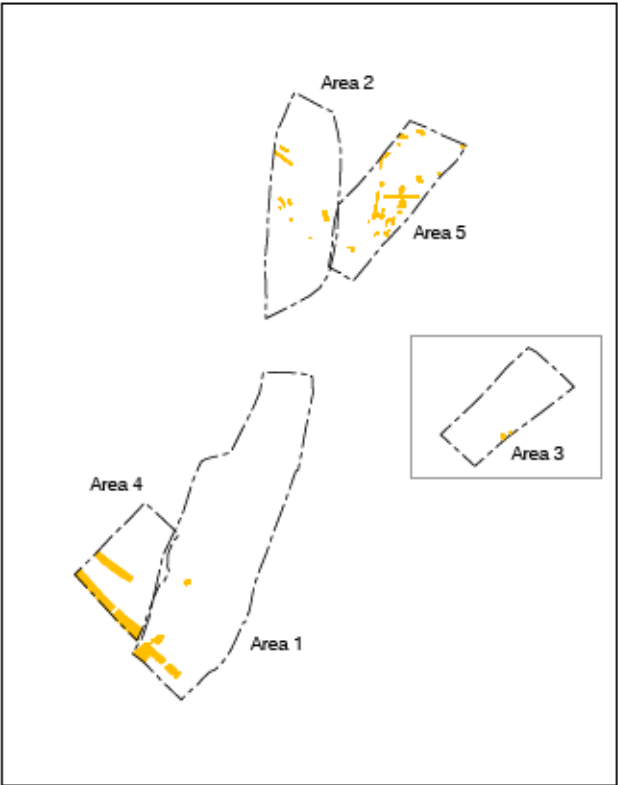

Figure 5c
Phase 2; Area 3
Late Bronze Age/Early Iron Age Features
1:250 at A4

- 3.4.2 In Area 1, there were a number of discrete and intercutting ditches with a some isolated pits. To the north of Area 1 two parallel ditches were recorded, aligned east to west. The northernmost of these, ditch [202] ran over 18.60m from the eastern section and terminating close to the western limit of excavation. This consisted of a linear cut 1.0m wide and 0.50m deep with straight sides and a concave base. It was filled with grey brown silt clay (201) = (204) = (209) = (250). A fragment of daub was recovered from fill (204) (Appendix 7), eight sherds of pottery dating to 50BC-50AD from fill (201), one sherd dating to 50BC-50AD from (250) and forty-four sherds from (209) dating to 60-100AD (Appendix 8). To the south of this ditch [129] ran 12.70m eastward from the western limit of excavation and terminated to the east. This had a concave profile measuring 1.20m wide and 0.27m deep and was filled with light grey brown silt clay (128) = (135) = (136). Fill (128) contained two, incomplete fired-clay 'Belgic' bricks broadly dated to the Iron Age and thirty-nine sherds of pottery dating to 0-60AD. Fill (135) contained seventeen sherds of pottery dating to 43-100AD, while three sherds of pottery dated to 0-60AD were recovered from (136).
- 3.4.3 These two elements closely correlate with two features recorded in Trench 3 of the 2008 Phase 1 evaluation. Cuts [35] and [37], shown as butt-ending linear features, correspond to the lines of [202] and [129] respectively and the fact that they were excavated as rounded termini probably reflects that they were excavated in evaluation trenches and the nature of the fills and the limited excavation area precluded the full extents of [35] and [37] to be recognised.
- 3.4.4 To the south of these contexts, and close to the western limit of excavation an irregular linear feature [256] ran 15.96m north to south and terminated to the south. This had a concave profile 1.05m wide and 0.46m deep and was filled with mottled mid-red brown grey silt clay (255) = (271) = (268) = (272). Fills (255) and (268) each contained fragments of an unidentifiable clay object of broadly prehistoric date, while fourteen sherds of pottery dated 0-50AD were recovered from (255). This feature is projected to run into the north-eastern corner of Area 4 to the west, but was not further identified due to ground conditions. Associated with this ditch were two pits; [248] and [254]. Pit [248] was a sub-ovoid and concave with a flat base, measuring 2.24m x 1.01m x 0.35m deep. This was filled with mottled mid grey brown silt clay (247), from which five sherds of pottery dating to between 43-60AD were recovered. To the south-east of this, cut [254] was sub-rectangular measuring 0.94m x 0.56m x 0.18m with concave sides to a concave base and filled with light grey brown silt clay, (253).
- 3.4.5 To the south of this a large semi-circular pit with concave sides to a concave base [145] was filled with a mid- to light red yellow silt clay (143) overlying mid-red grey silt clay (144), and measuring 4.95m x 2.96m x 0.46m deep. Six sherds of coarse flint and grog tempered pottery dated to the LBA/EIA and late Iron Age (LIA) and five sherds dating to 0-60AD came from fill (144) and twenty-six sherds dating to 43-100AD from (143).
- 3.4.6 Three parallel ditches were recorded running north-east to south-west to the south of Area 1. The first of these [132], sectioned variously along its length as [234] and [244], ran 31.25m from the southern to eastern limits of excavation. This consisted of a concave-profiled cut measuring between 1.40m and 1.80m wide and varying between 0.70m in depth to the north and 0.35m to the south. This was filled with an upper fill described as light yellow brown silt clay (137), brown orange yellow silt clay (130), light yellow brown silt clay (243), light yellow brown silt clay (267), grey orange yellow silt clay

(232) and light grey orange yellow silt clay (263). Four sherds of medium coarse flint tempered pottery of LBA/EIA date were recovered from (263), while three sherds of pottery dating 0-60AD were recovered from (243), and 41 sherds of pottery dating to 43-69AD were recovered from (267). This overlay a primary redeposited natural clay fill of mid to light orange brown silt clay (138) = (131) = (269) = (233) = (264). Fill (130) contained a single sherd of pottery dated to 50BC-50AD and a fragment of burnt cattle-size bone, while a second fragment of cattle-size bone was recovered from (131) (Appendix 9). Fill (276) contained a squat flake and a flake fragment.

- 3.4.7 To the east of this on a parallel alignment, ditch [228] comprised a linear straight sided cut with a concave base measuring 5.15m x 1.35m x 0.35m deep, filled with a mottled light to mid-orange brown silt clay (227) = (242). This is thought to terminate to the north, but the projected terminal was truncated by later features.
- 3.4.8 Further to the east, a third ditch section [150] was recorded. This ran on broadly the same alignment as ditches [132] and [228] for most of its 8.40m length before turning to the east. It consisted of a curvilinear cut measuring 0.76m wide x 0.51m deep and filled with a single light red orange clay silt redeposited natural fill (151) = (152). The alignment of [150] is partially estimated as weather conditions at the time of excavation made identifying it's full length problematic. It is thought to have terminated to the north where it was truncated by a later feature.
- 3.4.9 These three linears cut an underlying perpendicular ditch, [115], measuring 1.50m wide and 0.35m deep, which was filled with mid-orange brown silt clay (114) = (162) = (203) = (205). This ran south-east to north-west across the area from the eastern limit of excavation for a distance of 17.60m, and is postulated to continue into Area 4. In Area 4 however, its relationship with ditch [461] in Phase 2 (above) was not clarified in excavation, and was not discernible in plan due to prevailing site conditions. Fill (114) contained three sherds of pottery dated 0-60AD, fragments of cattle mandible and a single piece of burnt flint.
- 3.4.10 Ditch [115] was also cut at the western end by a series of pits. Feature [142] was an ovoid concave cut measuring 1.80m x 1.20m x 0.16m depth, and was filled with an upper fill of light yellow orange brown silt clay (140) overlying a primary deposit of mid-brown orange silt clay (141). Fragments of a cow maxilla and a basal fragment of cow horn core were recovered from (140), and a single sherd of shell or chaff tempered pottery dated to the 1st millennium BC from (141).
- 3.4.11 To the west of this cut [155] was sub-circular with straight sides and a concave base measuring 0.75m x 0.65m x 0.22m deep. This was filled with a mixed orange brown & blue grey silt clay (154). It in turn cut an ovoid pit with concave sides to a concave base [181], measuring 2.30m x 1.30m x 0.15m which was filled with an upper fill of mid-yellow orange sandy silt clay (179) overlying mottled mid-brown orange silt clay re-deposited natural primary fill (180). Two cattle mandibular molars from a c. 2 year old animal (probably from the same mandible), and a fragment of daub were recovered from fill (180). This in turn cut a larger sub-circular pit [196] = [125] with straight sides to a concave base. It was filled with mottled yellow orange brown silt clay (195) = (105) from which eighteen sherds of pottery dating to 43-100AD came.
- 3.4.12 To the south were a series of features, including a sub-circular pit [225] which extended from the

southern limit of excavation. This consisted of a concave feature measuring 1.20m x 1.00m x 0.28m depth, filled with a light grey blue silt clay (224).

- 3.4.13 In Area 4, two linear cuts were recorded. The first of these [446] = [448] was a north-east to south west aligned concave linear measuring 13.0m long, 1.34m wide and 0.54m deep, and terminating to the south. This was filled with greyish mid-brown silt clay (445) = (447).





- Excavated slot
- Phase 3 features

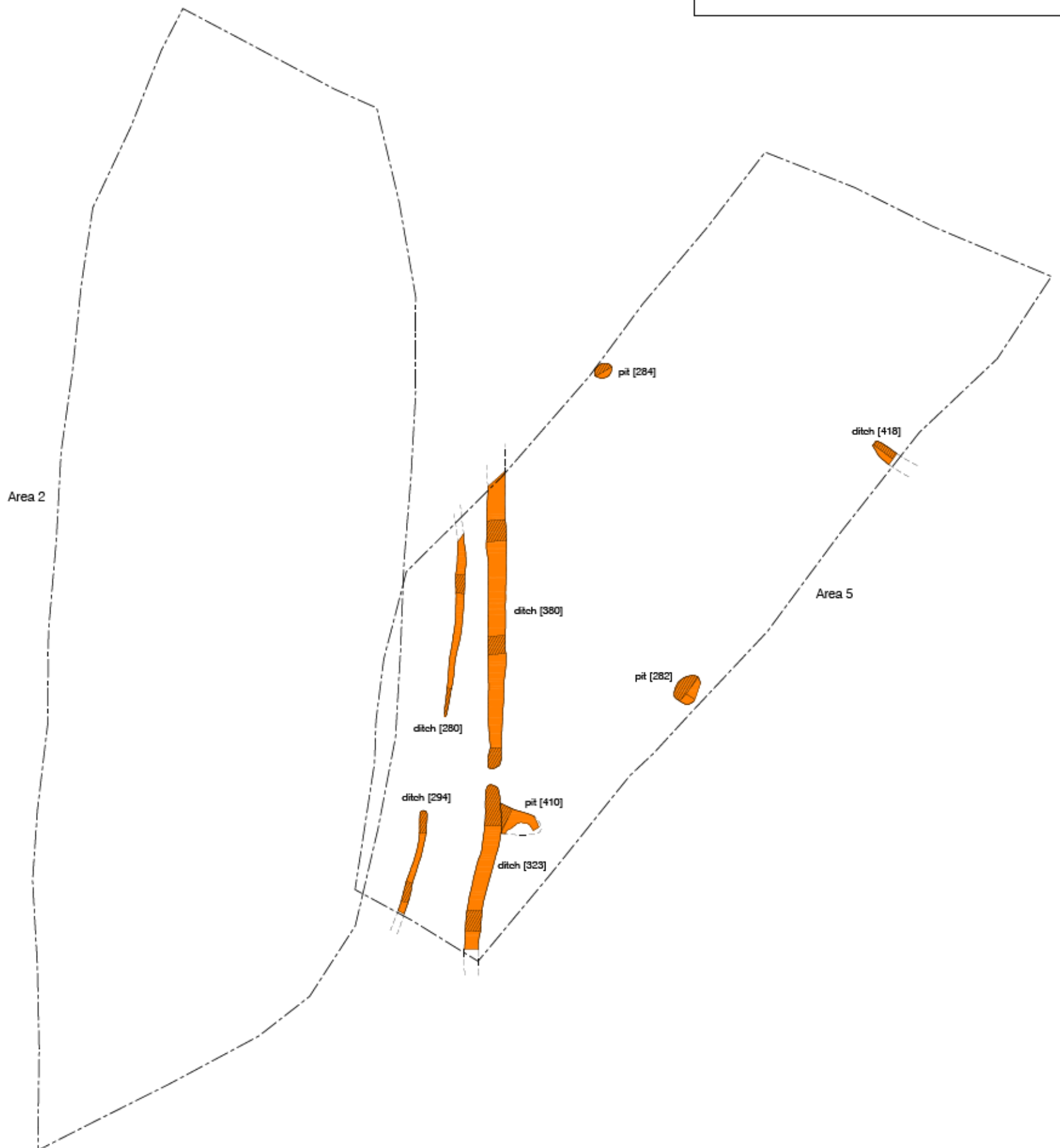

© Pre-Construct Archaeology Ltd 2012
24/10/12 HB

Figure 6a
Phase 3; Areas 1 & 4
Late Iron Age/Romano British Features
1:250 at A3



-  Excavated slot
-  Phase 3 features

0 10m

© Pre-Construct Archaeology Ltd 2012
24/10/12 HB

Figure 6b
Phase 3; Areas 2 & 5
Late Iron Age/Romano British Features
1:250 at A3

- 3.4.14 To the west of this was a second north-east to south-west aligned ditch [426] which ran into section to the south. This measured 20.60m, 0.85m wide and had a maximum depth of 0.60m. It was filled with dark yellow brown silt clay (425) = (449). No dating evidence was recovered from either these. The relationship between ditches [426] and [448] is obscured by truncation by features in Phase 3.
- 3.4.15 To the west of these a number of large pits were recorded. Pit [422] was a sub-circular cut measuring 2.14m x 1.60m x 0.37m deep, and was filled with mottled yellow grey silt clay (421). To the west of this sub-circular pit [431] had an upper fill of mid-orange brown silt clay (429) overlying a primary fill of mottled dark orange brown silt clay (430), and measured 1.64m x 1.00m x 0.55m deep. Further to the south was [444] which was sub-circular and measured 1.64m x 1.00m x 0.58m and was filled with an upper fill of mottled dark orange brown silt clay (442) overlying a primary fill of mottled mid orange brown silt clay (443). All three cuts had similar profiles with concave sides and a flat base.
- 3.4.16 To the west of these elements, pit [459] was sub-circular and measured 1.40m x 1.10m. It was excavated to a depth of 0.40m, but not bottomed. This was filled with mottled mid-orange brown clay silt (458). Four other features with similar sizes and fills were recorded to the south of this, but not excavated. Pit [451] was a sub-circular cut measuring 1.0m x 1.70m and filled with mottled mid-orange brown silt clay (450). This cut a further sub-circular pit [453] measuring 1.25m x 1.10m filled with a similar mottled mid orange brown silt clay (452).
- 3.4.17 Pits [455] and [457] were two smaller sub-circular cuts measuring 0.90m x 0.85m and 0.80m x 0.80m respectively and filled with mottled mid orange brown silt clay, (454) and (456), No finds were recovered from any of these, but their similarity in size and shape, and fills with that of ditch [277] suggests that they were of anthropogenic rather than natural origin.
- 3.4.18 A single cremation was recovered from Area 4. This had been placed in a small pit, [434], at the eastern limit of excavation measuring 1.28m x 0.70m and 0.37m deep. The eastern side of this pit was removed in the excavation of a drainage trench at the limit of excavation area. It had a primary fill of yellowish dark brown silty clay (441), probably representing re-deposited natural clay. This was overlain by a deposit of blackish brown, charcoal rich, silt clay (433) measuring 0.76m x 0.30m and 0.08m thick with a raised lip to the west, and was constrained to the west along a very straight axis, interpreted as representing the line of a vessel; presumably organic as no trace remained. A total of 7g of cremated bone was recovered from this deposit (Appendix 10), including two small skull fragments and an almost complete set of juvenile maxillary and mandibular teeth. This deposit represents the degraded remains of a cremation, probably originally contained within a wooden box.
- 3.4.19 This was overlain by a firm yellow brown silty clay (432), possibly representing a backfill of re-deposited natural clay over the cremation. Within this deposit a small near-complete ceramic vessel was found associated with the underlying cremated material, and 78g of fragmentary cremated human bone, including two sub-adult molars.
- 3.4.20 The cremated remains from these contexts represent fragmentary partial remains of a single individual aged between 5 – 10 years.
- 3.4.21 In Area 5, several other ditches were excavated, constituting possible boundary lines and four discrete pits. To the west of the area, ditches [280] and [294] were aligned north to south, forming an interrupted

ditch line. Ditch [280] was 10.40m long by a maximum of 0.55m wide and 0.35m deep, and terminated in an apparently rounded butt-end. This was filled with mottled mid-brown grey silt clay (279) = (295). To the south of this, a probable continuation of [280] was recorded. Ditch [294] was a similarly sized concave cut terminating to the north in a rounded butt-end. This was filled with mottled dark grey brown silt clay (293) = (296), and measured 5.70m x 0.35m with a maximum depth of 0.25m deep. A single sherd of undated pottery was recovered from fill (296).

- 3.4.22 To the east of these features a second pair of ditches was also aligned north to south with broadly equivalent, though less widely spaced termini. Ditch [380] was linear with a concave profile, measuring 15.60m long by 1.0m wide and 0.40m deep, and terminating in a rounded butt-end to the south. This was filled with an upper fill of mottled dark blue grey silt clay (378) = (381) = (393) which overlay a primary fill of mid-orange brown silt clay. Three fragments of variably burnt flint were recovered from (381) and a further two fragments of heavily burnt flint from (382). A split pebble with possible retouch near the bulbar end, possibly used as a knife, came from (393).
- 3.4.23 To the south of this a continuation element, ditch [323] had a concave-profile, 8.60m long by 0.90m wide with a maximum depth of 0.35m which was filled with mid-grey brown silt clay (322) = (334). It terminated to the north in a rounded butt-end and continued into section to the south. A fragment of possible fired clay 'Belgic' brick, five sherds of flint tempered LBA/EIA pottery and a rim sherd of a late IA round shouldered jar were found in fill (334), while a single sherd of pottery dating to 43-69AD was recovered from (322).
- 3.4.24 The terminal of ditch [323] cut a feature at its northern end. Context [410] was an irregularly shaped shallow pit with concave sides and a flat base. This measured 1.80m x 1.60m x 0.20m deep, and was filled with mid-grey brown clay silt (409), from which nine sherds of LBA/EIA and late Iron Age (LIA) flint tempered pottery and a miss-hit flint flake was recovered. The eastern edge of [410] was truncated by two intrusive natural features in Phase 5.
- 3.4.25 At the eastern limit of excavation feature [418] comprised an ovoid pit that may be the terminal of a ditch passing into section to the east. It measured 1.30m x 0.70m x 0.15m deep and was filled with grey brown silty clay (417), which contained a single sherd of pottery dating to 43-69AD.
- 3.4.26 Pit [282], was filled with mottled mid brown grey silty clay (281), and measured 1.55m x 1.20m and 0.20m deep. It was located against the eastern limit of excavation. Fill (281) contained a single sherd of pottery dating to 50BC-50AD. To the north of this, against the western limit of excavation, pit [284] measured 0.90m x 0.90m x 0.20m deep and was filled with mottled light brown grey silt clay (283). Fill (281) contained eleven fragments of burnt flint, while a sherd of fine quartz sand tempered pottery of LBA/EIA date and a single piece of heavily burnt flint were recovered from fill (283).

3.5 Phase 4: Continued Late Iron Age to Romano British Activity (Figure 7)

- 3.5.1 Deposits pertaining to Phase 4 are associated with continued or renewed activity of late Iron Age and early Roman date, and are distinct from the features of the preceding phase. They can be separated out on stratigraphic grounds and the type of activity represented. The Phase is represented by features in Areas 1 and 4.
- 3.5.2 In Area 1 the context associated with this phase consist of a segmented enclosure ditch, a linear outer

enclosure, a possible ditch segment and discrete post-holes.

- 3.5.3 Curvilinear ditches [183] = [198], [246] = [230], [194] and [147] form a probable segmented enclosure to the south of Area 1. Ditch [183] = [198] was a curvilinear ditch section with straight sides to a concave base, filled with a single fill of mid-grey brown silt clay (182) = (197) = (126) = (133). This measured 16.80m in length and varied in width between 0.68m and 1.20m and between 0.35m and 0.60m depth. A total of sixty-five sherds of pottery dating to 50BC-50AD were recovered from fill (133). Two molars from an adult cow also came from (133), with a further two molars from a sub-adult cow from fill (197) along with eighty-two sherds dating to 0-60AD. A fragment of sheep/goat axis and a 3rd maxillary molar from a horse of 7 years of age were recovered from fill (182). This molar derived from a small animal; either a small pony or a donkey. A fragment of beehive quern made from Worms Heath Puddingstone was also recovered from (182) along with twenty-five sherds of pottery dating to 50BC-50AD. A fragment of worn post-medieval peg tile (Appendix 11), dating to 1480-1900, and ascribed to cut [230] is likely to be intrusive from the excavation of Trench 14 and subsequent re-machining of the area.
- 3.5.4 To the north-east of this curvilinear ditch [230] = [246] measured 10.0m in length and varied in width between 1.40m and 1.60m and between 0.65m and 0.85m in depth. It was filled with light yellow brown silt clay (245) overlying pale grey brown silt clay (231) = (229) = (270). Two fragments of cattle-size long bone and a fragment of cattle scapula were recovered from fill (229). A fragment of sheep/goat humerus came from fill (245), along with a fragment of cattle mandible and equid 2nd and 3rd molars of a 13 – 15 year old animal. Again, these teeth came from either a small pony or donkey. A single retouched flake was recovered from fill (229). This consisted of the retouched distal end of a flake with crude flaking removing the bulbar end resulting in a double notched too, along with 29 sherds of pottery dating from 0-60AD. Fifty-eight sherds of pottery dating from 50BC-50AD were recovered from fill (245); and a fragment of post-medieval peg tile from the same context is again likely to be intrusive.
- 3.5.5 Two shorter ditch sections [194] and [147] to the north-east of this completed the enclosure. Ditch [194] consisted of a short ditch section with straight sides to a concave base, measuring 2.20m x 0.65m x 0.30m depth, and filled with two fills of mid-grey brown silt clay (192) and (193). Five sherds of pottery dating from 0-60AD came from (193). Cut [147] had a concave-profiled section measuring 3.60m x 0.60m x 0.55m depth, and filled with mid-grey brown silt clay (146) overlying dark grey brown silt clay (191). Fill (146) contained forty-seven sherds of pottery dating to 43-100AD, and fill (191) contained 12 sherds dating to 50BC-50AD. All of the sections of this probable enclosure had rounded, concave-profiled terminals.
- 3.5.6 Ditch [194] was cut towards its western end by an irregular concave, probably natural feature, [149]. This measured 3.60m x 2.40m x 0.25m deep and was filled by a dark red brown silt clay (148) which overlay a primary fill of mid-grey brown silt clay (190). Fill (148) contained seventy sherds of pottery dating to 43-100AD, including a sherd from a possible cheese press.
- 3.5.7 Ditches [198] and [246] broadly correlate to two features identified in Trench 14 of the 2002 evaluation. Here a curvilinear ditch [20] terminating to the west and a sub-circular feature [22] correspond to the termini of [198] and [246]. The excavated sections of [20] were recognized during the Area 1 excavation and were expanded during the excavation of [198]. The fact that the evaluation features

appear to be located c. 1.25m to the south-west of [198] and [246] is the result of survey error.

- 3.5.8 Two the south and west of this enclosure a linear gully [113] was recorded this ran 21.25m from south-east to north-east from the eastern to the western limit of excavation, and continued into Area 4 as ditch [438]. A probable entrance way in ditch [113] was defined by two concave-profiled termini. The ditch measured between 0.70m and 0.85m in width and between 0.10 and 0.45m deep, and was filled with light to mid-brown blue grey silt clay (139), (153), (122), (112), (161) and (104). Fill (104) contained three bone fragments and two teeth fragments from cattle or cattle size animals, and eight pottery sherds dating to 43-100AD. Two fragments of burnt flint were recovered from fill (112), along with thirty-eight fragments of pottery also dated to 43-100AD and two fragments of an unidentifiable fired clay object. Three sherds of pottery dated to 0-60AD were recovered from (122) and ten sherds of pottery dated to 0-60AD derived from (139). Eight sherds of pottery dating to 0-60AD came from fill (153), while three sherds of the same date from (161).
- 3.5.9 The termini of [113] may relate to two similar features in Trench 14 of the 2002 evaluation. Cuts [16] and [24] form the terminals of two curvilinear gullies, and while the excavated section of [16] was not identified in Area 1, it is likely that these features correspond to similar termini in Ditch [113]. Again, it may be the case that the disparity in location is the result of survey or rectification error.
- 3.5.10 To the north of this and broadly parallel, a short section of ditch or elongated pit [237] was recorded. This consisted of a short linear feature measuring 3.64m x 0.54m x 0.20m deep, with concave sides to a concave base and aligned south-east to north-west. This was filled with mid-brown grey silt clay (236). Twenty-three sherds of pottery dating to 0-60AD were recovered from this fill; a fragment of post-medieval peg-tile, dating 1480-1900, is likely to be intrusive.
- 3.5.11 Associated with these ditches were nine post-holes. Seven of these features were within or cutting the fills of enclosure ditches [183] = [198], [230] = [246]. Post-holes [107], [124], [117], [111], [119], [121] and [274] were circular concave features ranging in size between 0.36m to 0.94m in diameter, and between 0.06m to 0.43m depth. These were filled with dark grey silt clay and dark blue grey silt clay (106), (123), (116), (110), (118), (120) and (273) respectively. Nine sherds of pottery dating to 50BC-AD50 turned up in (118) and a single sherd of the same date from (273).
- 3.5.12 A further two post-holes were recorded to the south of these cutting ditch [113]. Cut [109] was circular and concave filled with dark grey silt clay (108), measuring 0.35m diameter and was 0.05m deep. A single sherd of medium fine quartz tempered pottery, broadly dated to the 1st millennium BC derived from (108). Cut [160] was circular and concave measuring 1.02m x 0.90m x 0.30m depth, and filled with mid-blue grey clay silt (159), dated to 43-69AD by three sherds of pottery.

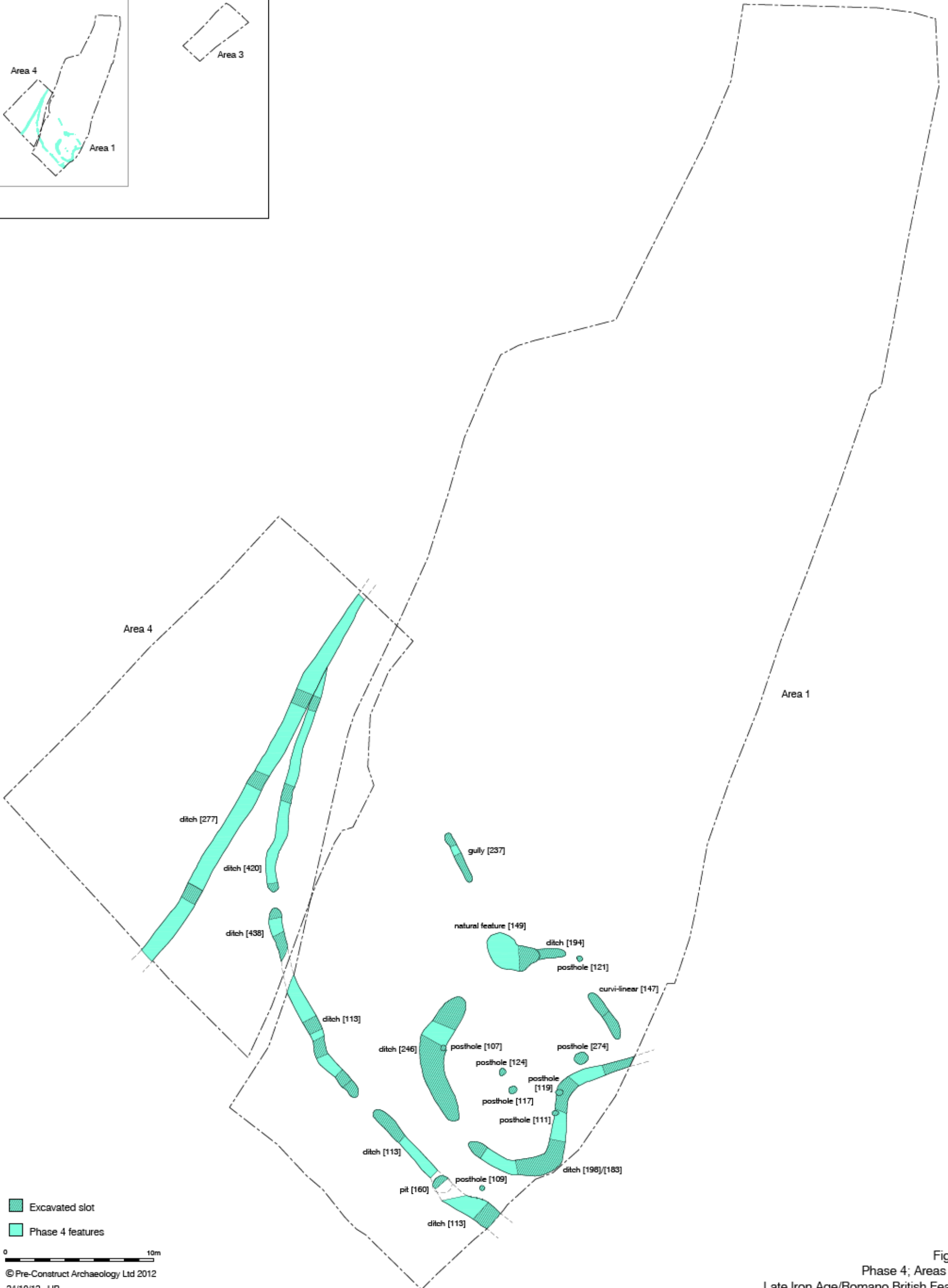

- Excavated slot
- Phase 4 features

0 10m
 © Pre-Construct Archaeology Ltd 2012
 24/10/12 HB

Figure 7
 Phase 4; Areas 1 & 4
 Late Iron Age/Romano British Features
 1:250 at A3

3.5.13 In Area 4, ditch [420] ran north to south and curved to the east. This consisted of a 15.20m section of ditch truncated at its northern end by ditch [420], terminating in a rounded butt-end to the south. This feature was filled dark grey silt clay, (419) = (439) = (436). Two sherds of shell and grog tempered pottery of LIA date and two sherds dating to 43-69AD were recovered from (436), while a single sherd of pottery from (419) dates to 43-69AD. A continuation of this feature was recorded as [438] to the south east, and was filled with brown grey silt clay (437), which was associated with thirteen pieces of variably burnt flint including angular shattered nodules, small pebbles and a piece of quartzite and twenty-two sherds of pottery dated to 43-100AD. Ditch [438] had a similar rounded butt-end forming a probable entrance in ditch [420] / [438]. This feature is a continuation of ditch [113], excavated in Area 1.

3.5.14 This was cut to the north of the trench by ditch [277] which ran 29.0m north-east to south-west across the length of Area 4. It consisted of a linear concave cut 1.10m wide and 0.35m deep filled by a light yellow brown silt clay (276) = (278) = (435). Five sherds of pottery dating to 50BC-50AD came from (435).

3.6 Phase 5: Post-Medieval Deposits (Figure 8a, 8b)



3.6.1 Post-medieval deposits were recorded in Areas 1, 2 and 5.

3.6.2 In Area 1 a single sub-rectangular pit with concave sides and a flat base [258] was identified toward the north of the area. This measured 2.84m x 1.44m x 0.49m depth and was filled with mid-orange brown grey silt clay (257). Six fragments of ceramic building material, including post-medieval brick and peg tile and burnt clay, dated to between 1664 and 1900 were recovered from the fill. A sherd of early Roman pottery dating to 0-50AD is considered residual in this context.

3.6.3 In Area 2 a linear gully [156] ran south-east to northwest across the area. This consisted of three sections of ditch, with convex sides to a flat base, and was equated as a single feature. It measured 24.30m in length, 0.55m wide and 0.10m deep, and was filled with mid brown grey silt clay (157). Two fragments of undecorated clay tobacco pipe stem (Appendix 12), Cornish slate and post-medieval peg tile suggest a 19th century date for the context.

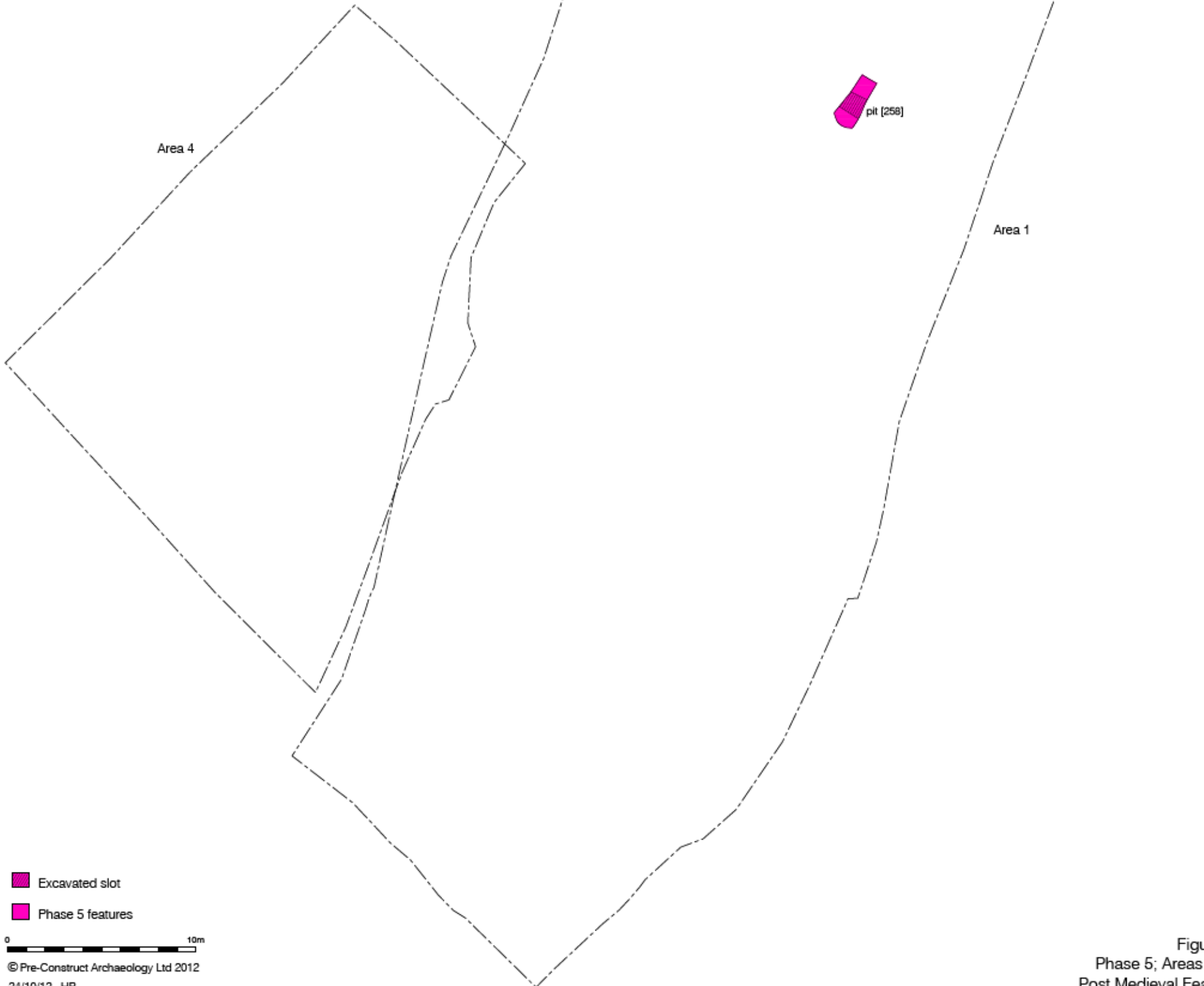
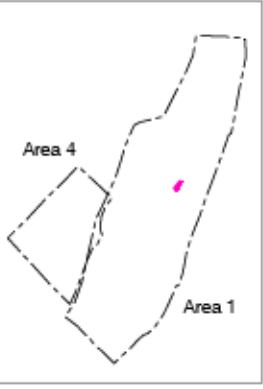
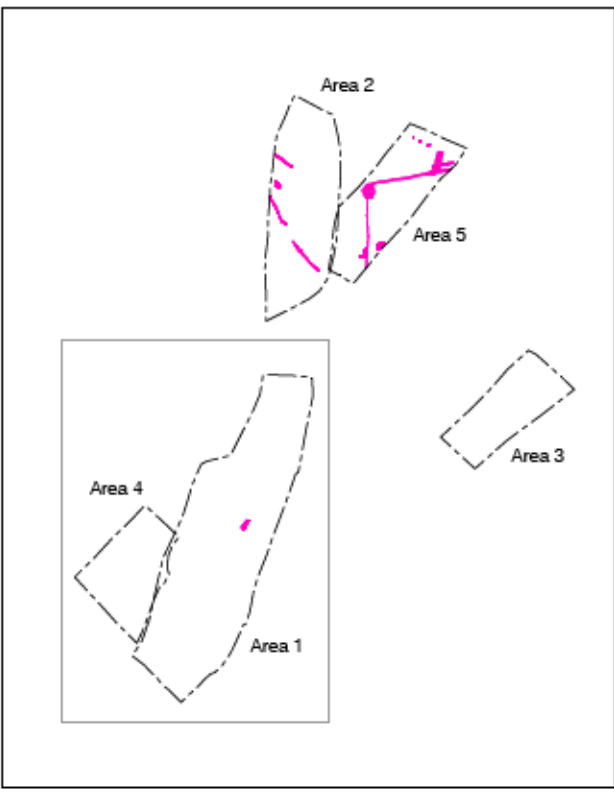
3.6.4 To the north of this, a second shallow gully [212] with concave sides and a flat base measured 5.50m x 0.50m x 0.10m in depth and was filled with mid-brown grey silt (213) from which two fragments of Cornish slate and post-medieval peg tile were recovered, dating to 1480 – 1900.



-  Excavated slot
-  Phase 5 features

0 10m
© Pre-Construct Archaeology Ltd 2012
24/10/12 HB

Figure 8a
Phase 5; Areas 1 & 4
Post Medieval Features
1:250 at A3

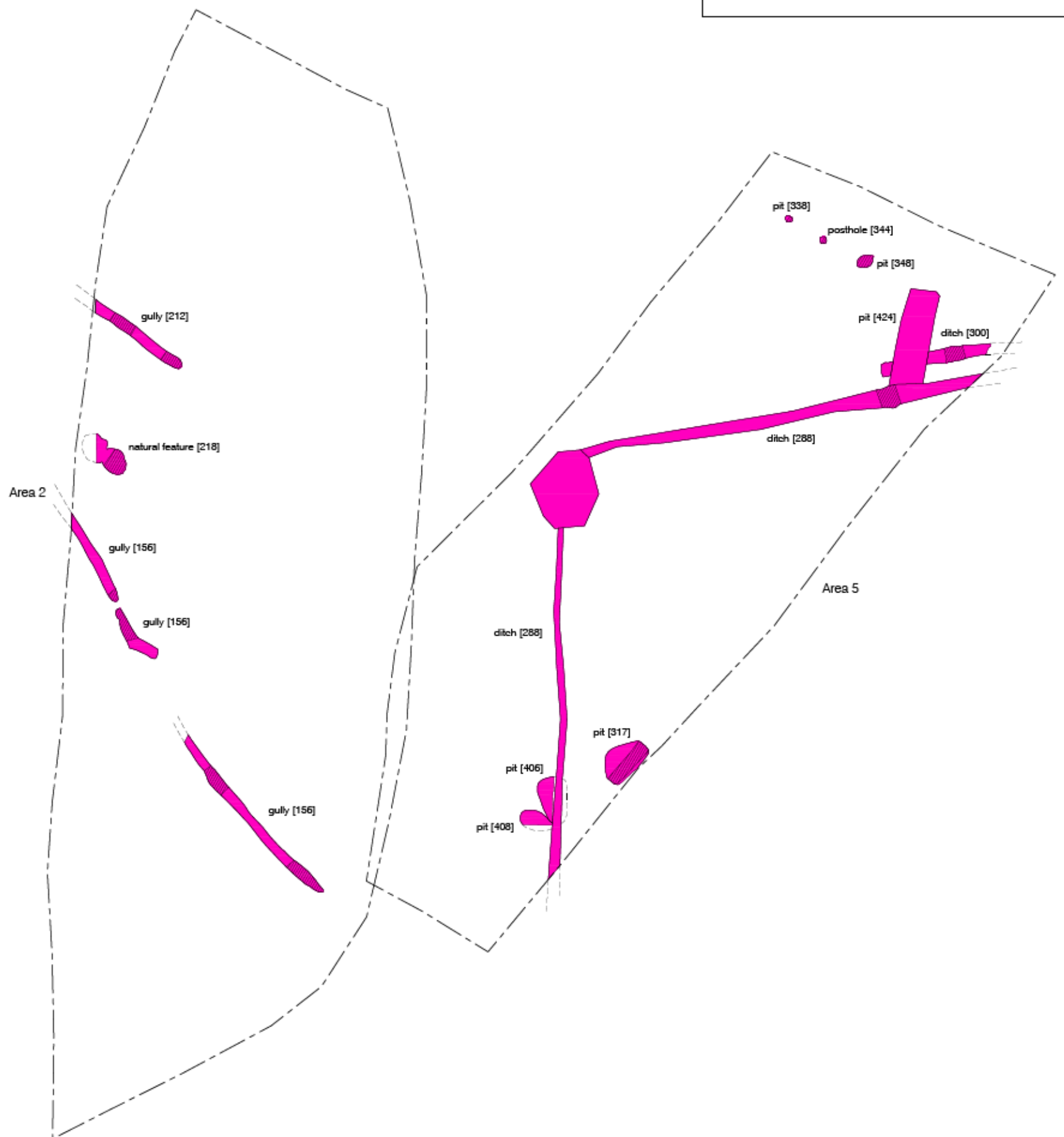
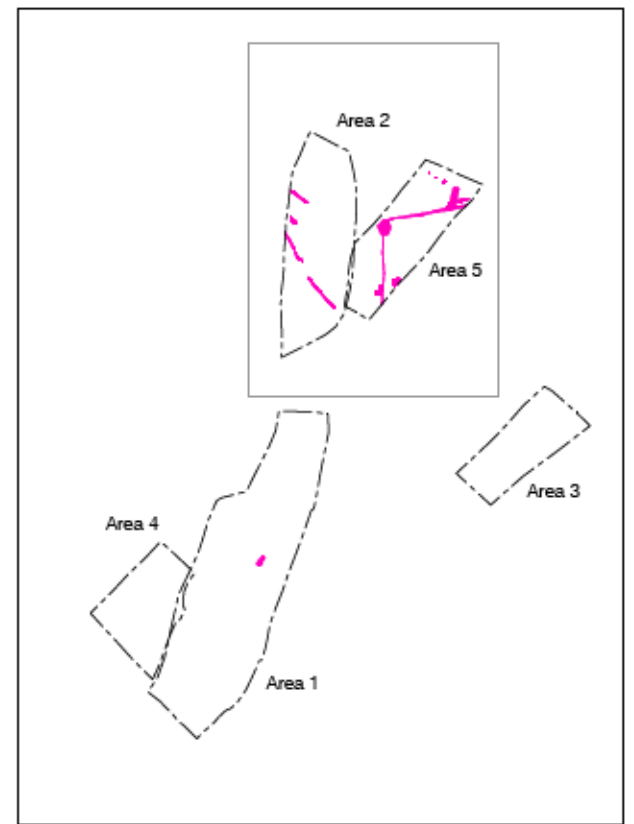

- Excavated slot
- Phase 5 features

0 10m

- 3.6.5 Between these two features a probable natural element [218] was recorded. This consisted of an irregular feature measuring 1.90m x 1.60m x 0.10m deep, and was filled with a mid-brown grey silt clay (219). A fragment of worn post-medieval peg tile, dated to between 1480-1900, was recovered from this feature.
- 3.6.6 In Area 4, the post-medieval deposits were limited to mid-orange brown silty clay subsoil (291) overlying the archaeological deposits of the previous phases to a depth of 0.50m.
- 3.6.7 In Area 5, a similar layer of mid-orange brown silt clay subsoil (289) had been heavily horizontally truncated by modern activity. This had been cut by a number of post-medieval and natural features.
- 3.6.8 A large ditch was apparent on the surface running north to south with a right angled return to the east prior to machine stripping of the area. This was recorded after the trench had been stripped, truncating the natural clay deposits. It consisted of a linear ditch [288] running 20m east-west from the eastern section of the excavation area then turning to the south; running a further 25m to the south-eastern corner of the area. It was 1.20m wide and had a v-shaped profile with straight sides to a concave base, and was a maximum 0.39m deep. It was filled with black to mid- to dark brown silt clay (287), from which no finds were recovered to definitively date the feature.
- 3.6.9 Close to the eastern limit of excavation, ditch [288] cut a large sub-rectangular pit [424]. This measured 4.80m x 1.70m and was unexcavated. Its fill, mid-brown grey silt clay with gravel (423) contained fragments of brick rubble, which were not retained. This in turn cut a short linear feature, [300]. This was an east to west aligned linear feature measuring 5.40m x 0.80m x 0.14m deep with squared termini, and filled with mid-brown silt clay (299) containing fragments of post-medieval ceramic building material dating to 1480-1900.
- 3.6.10 Ditch [288] also cut two natural tree-throws to the south of the Area. The first of these, feature [406] was ovoid and remained unexcavated measuring 2.40m x 0.80m and was filled with mid- to light brown silt clay (405). This cut a similar unexcavated feature, [408], measuring 1.70m x 0.75m, and filled with mid- to dark grey clay silt (407). A third-tree throw, [317], was recorded to the east of this. This consisted of a shallow cut with concave sides to a flat base measuring 2.60m x 1.70m x 0.18m deep, and was filled with mid- to dark brown clay silt with gravel (316). A single fragment of burnt quartzite was recovered from fill (316).

4 PHASE SUMMARY

4.1 Phase 1: Natural Deposits

4.1.1 The natural geology over the site consisted of firm orange brown glacial clay with spreads of coarse sandy flint gravel present within the glacial clays toward the top of the slope in Areas 2 and 5. This is consistent with the results of the geotechnical survey (quoted in Gailey, 2006).

4.1.2 A number of natural features were recorded in all excavation areas; some the probable result of tree rooting and some probably attributable to variations within the natural clay.

4.2 Phase 2: Late Bronze Age/Early Iron Age Activity

4.2.1 Deposits representing activity from the late Bronze Age to the early Iron Age were represented in all excavation areas. The nature of the activity is spatially differentiated between Areas 2, 3 and 5 at the top of the hill and the remains at the foot of the slope in Areas 1 and 4.

4.2.2 The densest concentration of features was located in Area 5 and appears to represent the periphery of domestic activity. The highest concentration of pits occurred at the angle of ditches [392] and [353] where a scatter of features may represent the bases of small rubbish pits or post holes. Further pits or post holes were present to the east of a continuation of [353], ditch [304]. Two further gullies in Area 2 may represent the continuation of these boundaries to the west. Those in Area 2 were on a north-west to south-east alignment rather than the north-south/east-west alignment of those in Area 5, and this may be a reflection of the break of slope to the west.

4.2.3 No structural alignments are evident within this spread of features suggesting that if these represent settlement, that this was located further to the east. No settlement activity is indicated in the phase 1 evaluation trenches (Seddon 2008), but this may be a result of more later development (and therefore greater truncation to the east).

4.2.4 Three possible cremations ([404], [357] and [377]) were identified in Area 5 and a further one ([185]) in Area 2. Of these, only [185] contained small fragments of burnt bone. Soil analysis has indicated a medium to strong soil acidity (Appendix 6), and this may have resulted in the degrading of bone from these features. The fills of all four of these features showed small quantities of burnt flint and charcoal (Appendix 5), and two contained relatively large quantities of fragmentary flint tempered pottery that may represent the remains of cinerary urns. While it is not possible to say with any certainty that these features were cremations, it appears on balance likely that the fills represent degraded cremations rather than either casual disposal of hearth rake-out or the bases of burnt-out posts.

4.2.5 Two more probable cremations were excavated during the Phase 1 evaluation, to the north of Trench 6. These consisted of two sub-circular cuts [56] and [58] filled with dark grey silt clay and containing charcoal and calcined bone (Seddon, 2008). Neither of these cuts was identified in the excavation of Area 2, or indeed any of the other features reported in Trench 6. This is likely to be as a result of differential machining between the two trenches.

4.2.6 These features, provisionally identified as settlement remains, appear to be confined to the top of the slope and to disappear below the crest of the slope on about the 40.5m contour. The features in Area 3, consisting of two pits or possibly ditch terminals were found slightly below this contour, but broadly

conform to this distribution.

- 4.2.7 By contrast, the features at the base of the slope consist of linear ditches with a single pit. A pair of parallel ditches was recorded running with the contour of the slope. The southernmost of these was cut by two intercutting ditches running down the slope. It is thought probable that these features represent field boundaries.
- 4.2.8 The pottery conforms to the late Bronze Age to early Iron Age post Deverel-Rimbury tradition, but the small size of the assemblage and the lack of diagnostic sherds makes narrowing the date range problematic, but the fabric types probably place the Phase later in this period (Appendix 3).
- 4.2.9 The vast majority of the lithics and burnt stone from this phase are derived from contexts in Areas 2 and 5. The struck flint is considered to be mostly expediently produced and typical of the ad-hoc use of flint from late prehistoric settlement and field systems (Appendix 4). The exception to this is a single piece of struck flint from ditch [207]; the distal end of a prismatic blade. This appears to be an attempt at microlith manufacture of probable Mesolithic date, and is considered to be residual. The burnt stone is again predominantly from Area 5, and represents incidentally produced hearth debris.

4.3 Phase 3: Late Iron Age to Romano-British Field System

- 4.3.1 Phase 3 represents a change in focus of activity on the site, with the majority of features now lying to the south of the site in Areas 1 and 4. These features appear to represent a re-working and intensification of the field system during the later part of the 1st century BC and into the 1st century AD.
- 4.3.2 The contextual elements consist of a series of ditches, predominantly to the foot of the slope, and superimposed over the probable field boundaries represented in Phase 2. The main east – west axis appears to have been reinforced from Phase 2, with ditch [115] being cut slightly to the north of Phase 2 ditch [223]. This is projected to have continued through into Area 4 to the west, but the differentiation between it and Phase 2 ditch [461] was not clarified in excavation.
- 4.3.3 Two short sections of ditch, [150] and [228], to the east may represent a continuation of the field system represented in Phase 2, with minor re-positioning of boundaries with the existing system.
- 4.3.4 Two broadly parallel ditches [129] and [202] to the north of Area 1 may comprise either an extended field system or the creation of new boundary lines within the existing system to create additional smaller fields. A further re-working of the system may be represented by two later ditches, [132] = [244] = [234] and ditch [426], which do not appear to conform to the existing boundaries, but may reflect a change of activity focus and consequent realignment of boundaries.
- 4.3.5 Two parallel ditch terminals, [426] and [446] = [448] may be drainage ditches bounding a narrow farm trackway or similar access, although no definitive indications of this are present. A series of pits to the west of the area may also argue for a localised change of function.
- 4.3.6 A single cremation was associated with this phase. Pit [434] consisted of a sub-circular feature with a basal fill of charcoal rich silt clay. This lay in a constrained axis to the west, thought to represent the line of an organic, probably wooden, vessel. Partial remains consisting of skull fragments and maxillary and mandibular teeth were recovered from the fill, indicating that a single juvenile individual aged

between 5 – 10 years old was present (Appendix 10). The recovered bone fragments were brownish grey in colour, and thus not fully oxidised. This in conjunction with the acidity of the soils previously noted may account for partial preservation of these remains.

- 4.3.7 To the north, in Area 5, the north – south alignment of ditches provisionally identified as settlement ditches in the previous phase appear to have been re-worked in a similar way. This again suggests continuity of activity in this area, although the reduced number of pits or post holes in Area 5 would suggest that the focus of this activity had moved.

4.4 Phase 4: Late Iron Age to Romano British Activity

- 4.4.1 Phase 4 is represented by features in Areas 1 and 4. The preceding Phases represent a field system apparently based on linear ditches, while Phase 4 represents a possible change in form or function of the agricultural activities with the imposition of a sub-circular segmented enclosure with a curvilinear enclosure to the south and west. A straight linear in Area 4 appears to echo the western ditch alignments.

- 4.4.2 This enclosure appears to have been superseded by a scatter of isolated post holes with no recognisable pattern to suggest a structure.

- 4.4.3 The separation of features between Phases 3 and 4 is based on stratigraphic relationships and the nature of the fills, rather than artefactual evidence. Pottery spot dates suggest a rapid transition between the activities in the two phases.

- 4.4.4 Of interest in this phase is the possible presence of remains of a small pony or donkey from the fills of the enclosure (Appendix 9). Whilst the identification of these remains is by no means certain, very few examples from the Roman period are known. Also of interest is the presence of a fragment of beehive quern in Worms Heath Puddingstone Appendix 11). Whilst these are known south of the Thames, this may be the first example from north of the river.

4.5 Phase 5: Post-Medieval Deposits

- 4.5.1 Phase 5 deposits were present in Areas 1, 2 and 5. These represent both natural and intrusive features of 19th and 20th date. Intrusive ditches and gullies pits were recorded in Areas 2, 4 and 5.

- 4.5.2 These features are of no archaeological significance.

5 SUMMARY AND SIGNIFICANCE OF THE ARCHAEOLOGICAL SEQUENCE

- 5.1 The site shows continuous settlement through the later prehistoric and into the Romano-British transitional period.
- 5.2 The activity appears to be constrained to the south-west of the development area, and appears to be absent from the majority of the former hospital site. This could be the result of either historic truncation during the 20th century and/or the extent of the settlement activity is constrained to the small promontory on the west facing slope of the valley.
- 5.3 Whilst it is possible to broadly date and phase the features recorded in the excavation, the paucity of artefactual evidence has made it difficult to refine the dating or phasing of the site further. The majority of the finds appear to represent local technologies and traditions, and would indicate a small scale short-lived rural farmstead type use.
- 5.4 The bulk of the pottery from the site was recovered from Area 1 in Phases 3 and 4 (Appendix 8). The date range for both phases suggest that the activity spans the late Iron Age and early Roman transition, and comprises a variety of handmade, wheel turned and wheel-made vessels. The majority of the fabrics were grog-tempered wares with sandy wares and a small number of white wares making up the remainder. Domestic wares were predominant and the lack of imported wares is taken to indicate the low status of the site or to reflect the absence of imported wares at the time of the Roman conquest.
- 5.5 In general, the pottery recovered was small in size and there appeared to be little sign of sooting or residues on the ceramics, and the majority showed signs of wear. This perhaps indicates that the pottery has been re-deposited from elsewhere, perhaps as a result of ploughing and manuring.
- 5.6 In contrast, the lithic assemblage (Appendix 4) is noted as not being worn and therefore probably found close to the source of production. It is further noted that the flint is probably produced on an ad-hoc, opportunistic basis using locally sourced material, and is limited in frequency, suggesting perhaps that the use of worked flint on site was coming to an end in this period. The burnt stone is considered to be indicative of accidental production from hearths built on the ground, rather than from the considered production of pot-boilers.
- 5.7 Within the flint assemblage is one flake from Phase 2 that may be the result of microlith production. This is thought to be Mesolithic and is of note given the paucity of material of this date in the area.
- 5.8 The animal bone consisted of bone fragments and teeth from cattle or cattle-size animals from two ditches and two pits, one of which is identified as an adult and one as sub-adult. This may indicate animals bred for meat, but the assemblage is considered too small for meaningful interpretation (Appendix 9). Again, this may be due to the acidity of the surrounding soils.
- 5.9 The tentative identification of a donkey is of significance given the small number of instances in Roman Britain. Also of note is the presence of a fragment of beehive quern made from Worms Heath Puddingstone; believed to be the first found north of the Thames (Appendix 11).

6 ORIGINAL RESEARCH AIMS AND REVISED RESEARCH AIMS

6.1 Original Research Aims

6.1.1 The Written Scheme of Investigation (Gailey, 2011) defined specific aims and objectives for the excavation. These are reproduced below, each aim being followed by a summary of the extent that the fieldwork attained the aim:

General Aim 1: Definition of the extent, character and chronology of the Iron Age/Romano British settlement activity on the site

6.1.2 The excavation demonstrated that significant archaeological deposits and features dateable to the Late Bronze Age/Early Iron Age and to the late Iron Age/early Roman periods representing activity peripheral to a probable and a continued and developing field system to the south of the site.

6.1.3 Finds evidence suggests local technologies and indicates the rearing of cattle for meat.

General Aim 2: Define the extent and character of any Iron Age cemetery activity on the site

6.1.4 The excavation demonstrated funerary activity over the site. This seemed to be spatially differentiated between the two main periods represented on site. To the north, the cremations appear to be related to the late Bronze Age and early Iron Age settlement activity at the top of the slope, whilst the single early Roman cremation was associated with ditches of the field system. There may also be a distinction in the type of cremation practice between the two periods. During the late Bronze Age/early Iron Age the cremations appear to be either un-urned or within now heavily degraded vessels. The single cremation in the early Roman period appears to be a box-cremation.

General Aim 3: Clarify spatial and chronological changes in activity on the site

6.1.5 The excavation demonstrated the changing temporal and spatial changes in the changing focus of settlement activity and the evolution of the field system. There also seems to be a spatial distinction between settlement and agricultural activity on the site, with settlement activity seemingly confined to the top of the slope and the field system to the base of the slope.

General Aim 4: To establish the character of archaeological remains and to place these within the context of the landscape, settlement and activity patterns in the area.

6.1.6 Given the paucity of sites and find spots from the surrounding area, it is difficult to place the site in the context of the wider area, other than to place it in the general context of small, short-lived agricultural activity along the upper slopes of the valley sides in Essex and along the Roman roads. It is not certain whether this lack of apparent activity is the result of a lack of activity or a lack of archaeological interventions in the area. The lack of environmental evidence from the site, attributed to the acidity of the soils, makes it difficult to place the site within the wider local environment

6.2 Revised Research Aims

6.2.1 Following from the investigations, a number of revised research aims and interests have been identified. These include but are not limited to:

- In so far as it is possible, to describe and define the Late Bronze Age/ Early Iron Age use of

the landscape, and to compare or contrast this with the more intensively studied gravel terraces further west.

- To more precisely date the site occupation, as represented by the artefactual assemblage and to establish how it fits within its wider regional context and local affinities
- In so far as it is possible, to establish by comparison sites within the wider area whether it is possible to distinguish changes in land use between upper- and down-slope activity, and activity migration with time.

7 RECOMMENDATIONS FOR FURTHER WORK

7.1 Publication Proposal

7.1.1 Following the recognition of the significance of the findings from the Evaluation and Excavation, publication in an appropriate Journal, such as London Archaeologist or Essex Archaeology and History, is recommended. Themes that the publication will focus on are outlined below. Some of the themes will be addressable from the syntheses and discussion already undertaken, although this information will need enhancing. Others will require the undertaking of further research to achieve them (4.2 above).

7.2 Late Prehistoric/Romano-British Transitional Settlement and Land-Use

7.2.1 It is increasingly becoming apparent that by the later Bronze Age much of the landscape of the lower Thames Valley and elsewhere in southern Britain was being organized into extensive tracts of fields and trackways, interspersed with small settlements. This represents a major reorganization of the landscape from one dominated by monuments or where settlement and economic practices are all but archaeologically invisible to a significantly managed and organised one.

7.2.2 The investigations here provide further evidence for occupation during this period in the vicinity of the site, although such extensive agricultural landscapes have been recorded elsewhere in the east London area. The publication will consider the evidence for the Late Bronze Age /Early Iron Age and the Iron Age/Romano-British transitional activity at this site within the context of similarly dated evidence from the wider region. It will require consultation of and research into the relevant published and unpublished sources.

7.2.3 In order to facilitate this it is recommended that further characterisation of the late Bronze Age/early Iron Age pottery, and of the Iron Age and Romano British pottery and considered within its wider context. No further analytical work is recommended for the remaining finds types but further consideration of the Worms Heath Puddingstone should be included in any discussion of the finds assemblage in its wider context.

8 ACKNOWLEDGEMENTS

- 8.1 The author, on behalf of Pre-Construct Archaeology Ltd, would like to thank CgMs Consulting for commissioning the work and Countryside Properties Ltd for generously funding the project, and to their site representatives for their assistance, particularly through the second phase of excavations. Thanks are due to Adam Single and Laura O’Gorman of the Greater London Archaeological Advisory Service and Suzanne Gailey for their help and advice on site. Many thanks to Chris Mayo of Pre-Construct Archaeology Ltd as project manager and Frank Meddens as Post-Excavation manager. Also thanks to all the specialists who have contributed to this report and to Hayley Baxter for the illustrations.
- 8.2 Special thanks are also due to all the field staff for their hard work on site, under frequently wet and muddy conditions.

9 APPENDIX 1: STRATIGRAPHIC MATRICES

MATRIX AREA 5

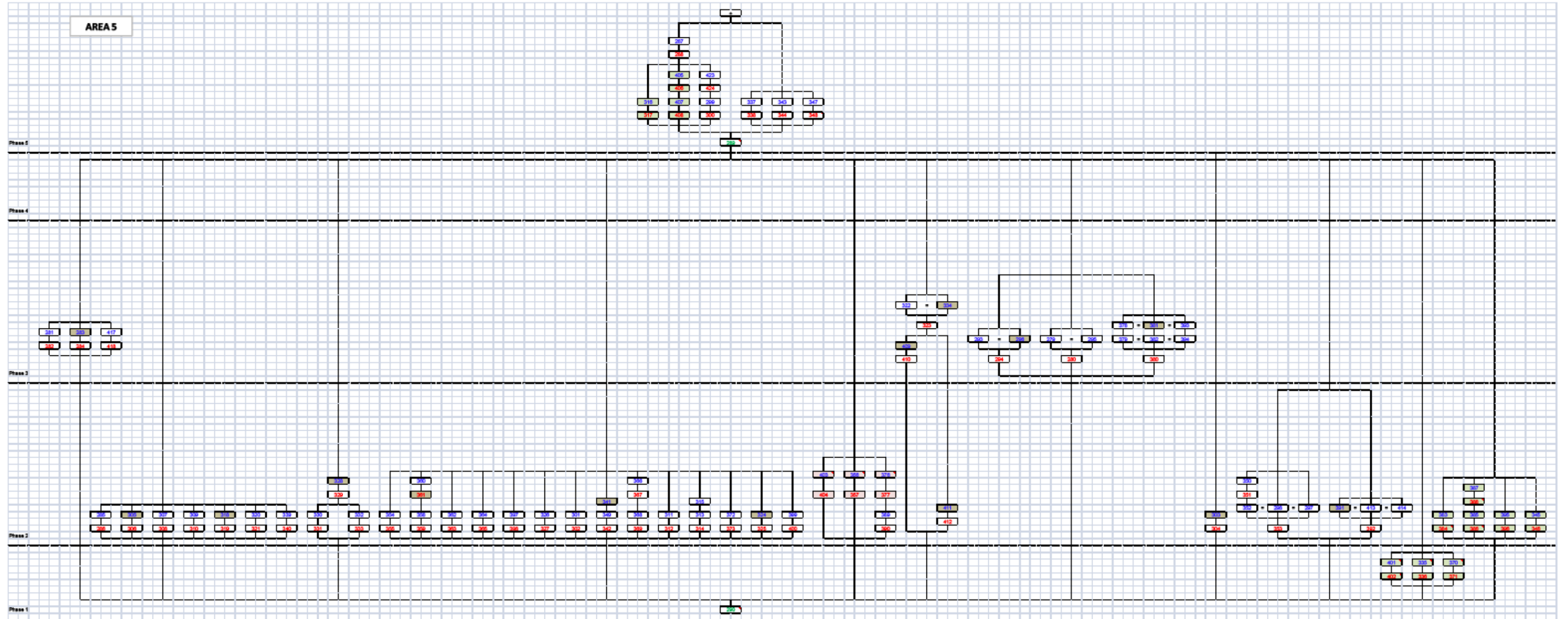

MATRIX AREA 4

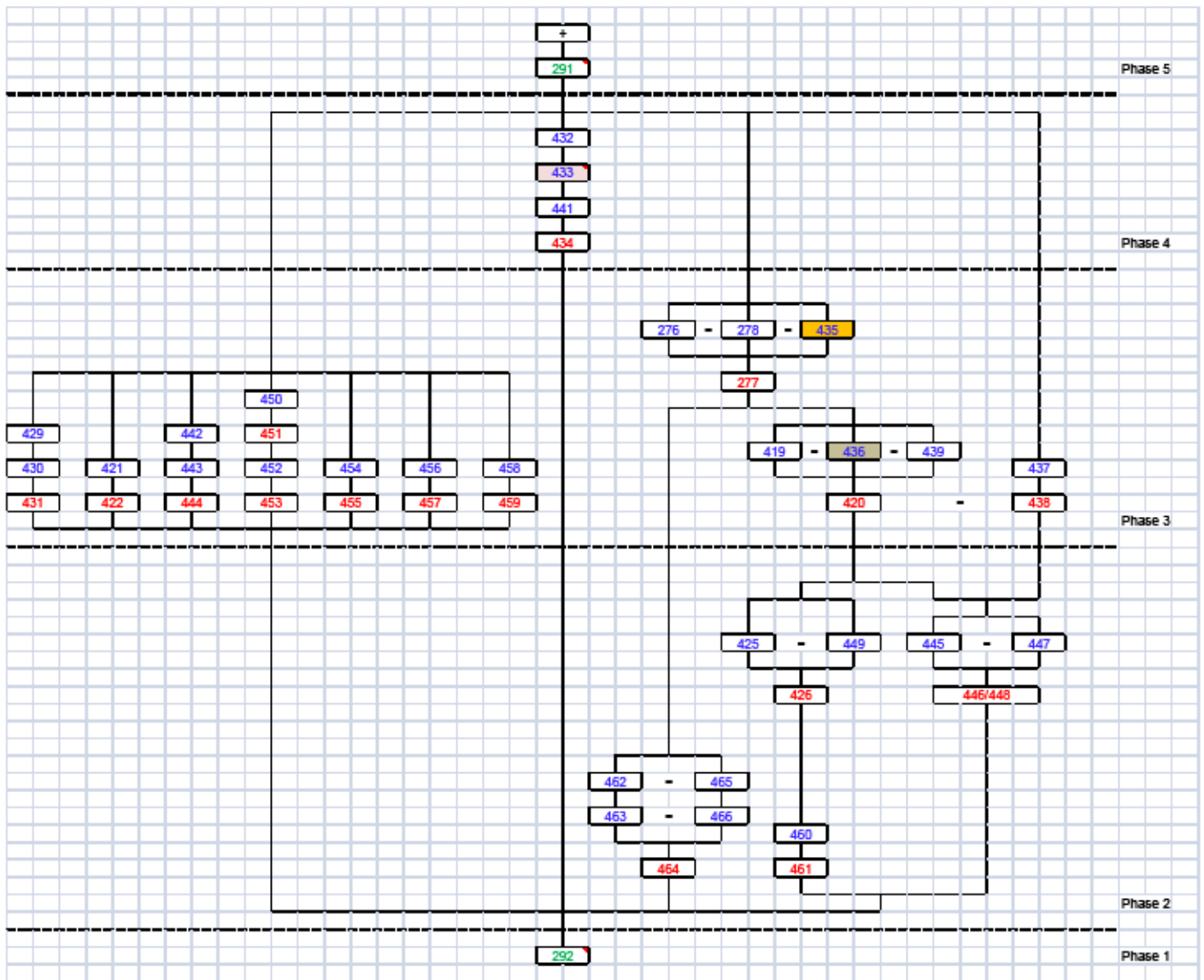

MATRIX AREA 3

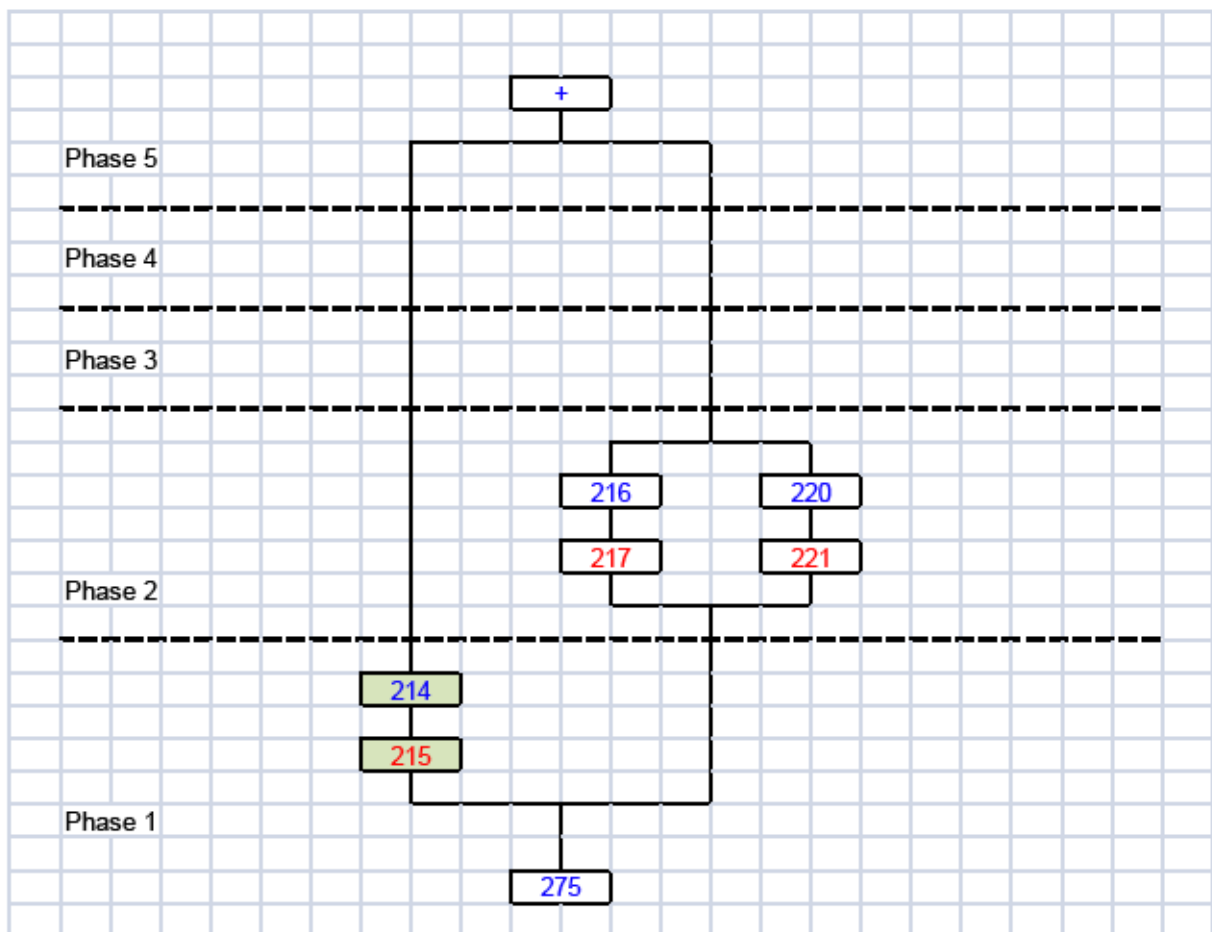

MATRIX AREA 2

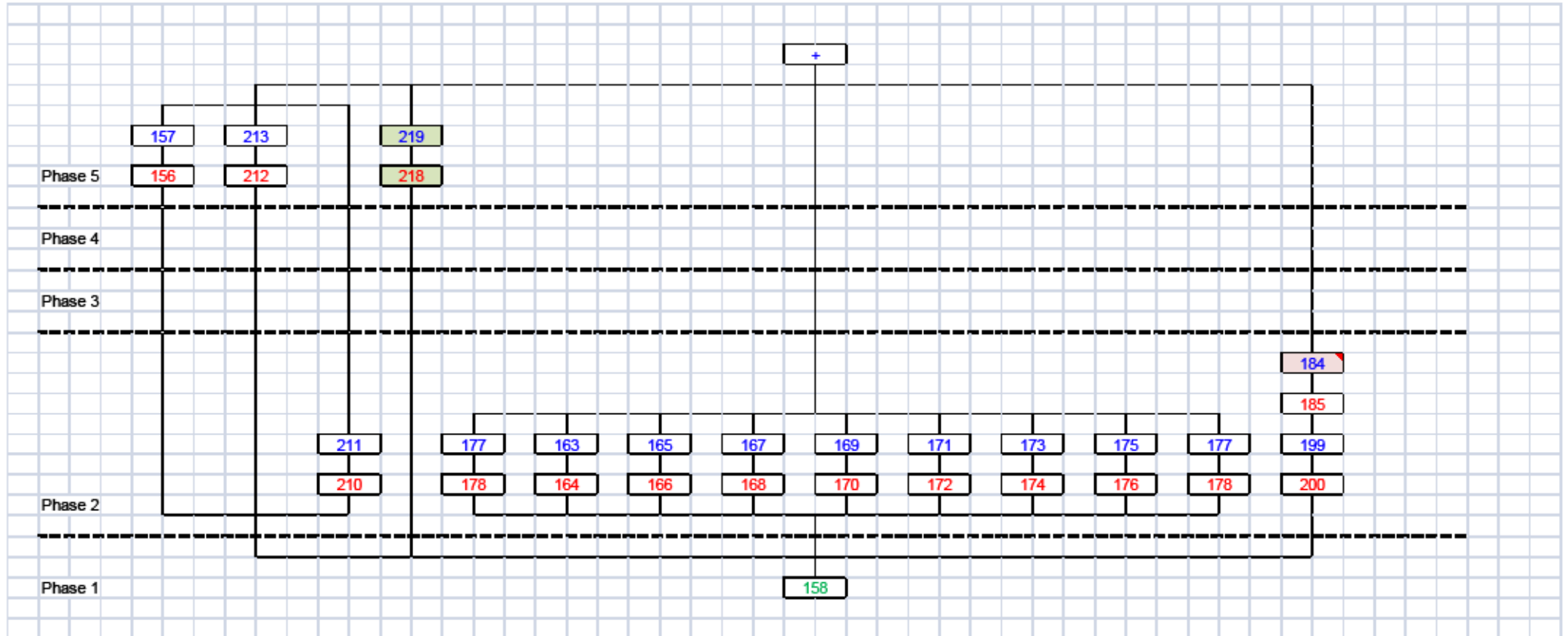

MATRIX AREA 1

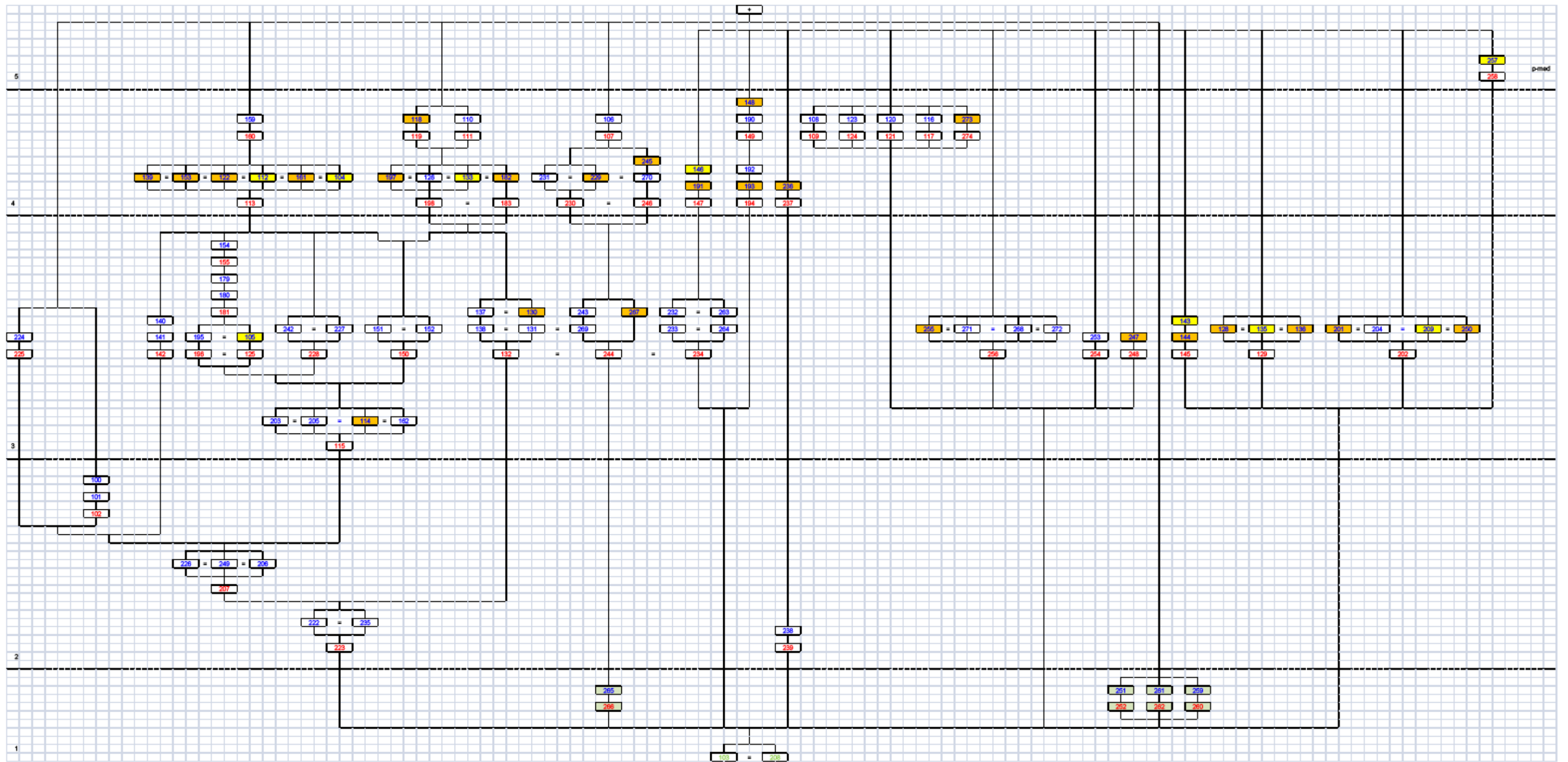

10 APPENDIX 2: CONTEXT INDEX

Context No	Trench	Interpretation	Description	N-S (m)	E-W (m)	Depth (m)	High (m OD)	Low (m OD)	Phase	Prov date
100	Area 1	fill of [102]	Pale grey clay	4.02	0.22	0.23	35.86	35.86	2	LBA/EIA
101	Area 1	Fill of [102]	Pale brown pink clay	4.02	0.85	0.45	35.86	0.00	2	LBA/EIA
102	Area 1	Gully	Linear, concave sides to concave base	4.02	0.85	0.45	35.86	35.43	2	LBA/EIA
103	Area 1	Natural	Mid-orange brown silt clay	0.00	0.00	0.00	38.33	35.92	1	Natural
104	Area 1	Fill of [113]	Blue grey silt clay	1.40	1.00	0.45	35.80	0.00	4	LIA/ER
105	Area1	Fill of [125]	Yellow brown clay	2.10	1.00	0.70	35.50	35.80	3	LIA/ER
106	Area 1	Fill of [107]	Firm dark grey silt clay	0.38	0.32	0.07	36.20	0.00	4	LIA/ER
107	Area 1	Posthole	Circular, concave sides to flat base	0.38	0.32	0.07	36.20	36.13	4	LIA/ER
108	Area 1	Fill of [109]	Dark grey silt clay	0.35	0.35	0.05	36.06	0.00	4	LIA/ER
109	Area 1	Posthole	Circular, concave sides to flat base	0.35	0.35	0.05	36.06	36.01	4	LIA/ER
110	Area 1	Fill of [111]	Dark grey silt clay	0.36	0.46	0.11	36.30	0.00	4	LIA/ER
111	Area 1	Posthole	Ovoid, concave sides to flat base	0.46	0.36	0.11	36.30	36.19	4	LIA/ER
112	Area 1	Fill of [113]	Mid-brown blue grey sandy clay	1.40	1.00	0.30	36.06	0.00	4	LIA/ER
113	Area 1	Ditch/gully	Linear concave sides to concave base	21.25	1.40	0.30	36.06	35.68	4	LIA/ER
114	Area 1	Fill of [115]	Mid-orange brown sandy silt clay	1.00	1.50	0.35	36.04	0.00	3	LIA/ER
115	Area 1	Ditch	Linear, concave sides to concave base	1.50	17.60	0.35	36.04	35.31	3	LIA/ER
116	Area 1	Fill of [117]	Dark grey silty clay	0.46	0.56	0.14	36.19	0.00	4	LIA/ER
117	Area 1	Posthole	Circular, concave sides to flat base	0.46	0.56	0.14	36.19	36.05	4	LIA/ER

Context No	Trench	Interpretation	Description	N-S (m)	E-W (m)	Depth (m)	High (m OD)	Low (m OD)	Phase	Prov date
118	Area 1	Fill of [119]	Dark grey silt clay	0.42	0.52	0.06	36.32	0.00	4	LIA/ER
119	Area 1	Posthole	Circular, concave sides to flat base	0.42	0.52	0.06	36.32	36.26	4	LIA/ER
120	Area 1	Fill of [121]	Dark grey silt clay	0.36	0.38	0.14	36.43	0.00	4	LIA/ER
121	Area 1	Posthole	Circular, concave sides top concave base	0.36	0.38	0.14	36.43	36.29	4	LIA/ER
122	Area 1	Fill of [113]	Light brown blue grey silt clay	0.00	0.00	0.15	35.88	0.00	4	LIA/ER
123	Area 1	Fill of [124]	Dark grey silt clay	0.46	0.44	0.11	36.22	0.00	4	LIA/ER
124	Area 1	Posthole	Circular, concave sides to concave base	0.46	0.44	0.11	36.22	36.11	4	LIA/ER
125	Area1	Pit	Same as 196	0.00	0.00	0.00	0.00	0.00		LIA/ER
126	Area 1	Fill of [198]	Mid-brown grey silt clay	0.80	1.20	0.35	36.26	36.05	4	LIA/ER
128	Area 1	Fill of [129]	Light grey brown silt clay	12.70	1.20	0.27	37.52	0.00	3	LIA/ER
129	Area 1	Ditch	Curvi-linear, concave sides to concave base	12.70	1.20	0.27	37.94	37.27	3	LIA/ER
130	Area 1	Fill of [132]	Brown orange yellow silt clay	0.60	1.95	0.15	35.85	0.00	3	LIA/ER
131	Area 1	Fill of [132]	Mid-brown orange silt clay	1.60	1.95	0.20	35.85	0.00	3	LIA/ER
132	Area 1	Ditch	Linear, straight sides to concave base	31.25	1.60	0.35	35.85	35.42	3	LIA/ER
133	Area 1	Fill of [198]	Mid-grey brown silt clay	4.00	6.00	0.60	35.08	0.00	4	LIA/ER
135	Area 1	Fill of [129]	Light grey brown silt clay	1.20	0.70	0.07	37.94	0.00	3	LIA/ER
136	Area 1	Fill of [129]	Dark blackish grey silt clay	0.60	0.80	0.20	37.79	0.00	3	LIA/ER
137	Area 1	Fill of [132]	Light yellow brown silt clay	1.20	1.10	0.05	35.84	0.00	3	LIA/ER
138	Area 1	Fill of [132]	Light orange brown silt clay	1.20	1.10	0.20	35.84	0.00	3	LIA/ER
139	Area 1	Fill of [113]	Mid-brown blue grey silt clay	0.70	0.85	0.16	35.84	0.00	4	LIA/ER
140	Area 1	Fill of [142]	Light yellow orange brown silt clay	1.80	1.20	0.10	35.93	0.00	3	LIA/ER
141	Area 1	Fill of [142]	Mid-brown orange silt clay	1.80	1.20	0.05	35.93	0.00	3	LIA/ER

Context No	Trench	Interpretation	Description	N-S (m)	E-W (m)	Depth (m)	High (m OD)	Low (m OD)	Phase	Prov date
142	Area 1	Pit	Ovoid, concave sides to concave base	1.80	1.20	0.16	35.93	35.66	3	LIA/ER
143	Area 1	Fill of [145]	Mid - light red yellow silt clay	0.94	1.60	0.26	35.63	0.00	3	LIA/ER
144	Area 1	Fill of [145]	Mid-red grey silt clay	0.94	2.40	0.20	0.00	0.00	3	LIA/ER
145	Area 1	Pit	Sub-circular, concave sides to concave base	4.95	2.96	0.46	35.63	35.17	3	LIA/ER
146	Area 1	Fill of [147]	Mid-grey brown silt clay	3.00	0.60	0.13	36.45	0.00	4	LIA/ER
147	Area 1	Curvi-linear	Linear, concave straight sides to concave base	3.60	0.60	0.55	36.44	35.89	4	LIA/ER
148	Area 1	Fill of [149]	Dark red grey brown silt clay	1.10	2.10	0.15	36.29	0.00	4	LIA/ER
149	Area 1	Natural feature	Irregular, concave sides to concave base	2.40	3.60	0.25	36.37	36.09	4	LIA/ER
150	Area 1	Ditch	Linear, concave sides to concave base	8.40	0.76	0.51	36.06	35.55	3	LIA/ER
151	Area 1	Fill of [150]	Light red orange clay silt	0.51	1.05	0.20	36.02	0.00	3	LIA/ER
152	Area 1	Fill of [150]	Light red orange clay silt	0.37	1.35	0.20	35.85	0.00	3	LIA/ER
153	Area 1	Fill of [113]	Mid-brown blue grey silt clay	1.20	0.75	0.10	35.85	0.00	4	LIA/ER
154	Area 1	Fill of [155]	mixed orange brown & blue grey silt clay	0.75	0.65	0.22	35.80	0.00	3	LIA/ER
155	Area 1	Pit/posthole	Sub-circular, straight sides to concave base	0.75	0.65	0.22	35.80	35.58	3	LIA/ER
159	Area 1	Fill of [160]	Mid-blue grey clay silt	0.90	1.02	0.30	35.90	0.00	4	LIA/ER
160	Area 1	Pit	Circular, concave sides to concave base	0.90	1.02	0.30	35.90	35.57	4	LIA/ER
161	Area 1	Fill of [113]	Mid-blue grey clay silt	1.00	0.81	0.45	35.95	0.00	4	LIA/ER
162	Area 1	Fill of [115]	Mid-brown orange silt clay	1.00	1.41	0.41	35.98	0.00	3	LIA/ER
179	Area 1	Fill of [181]	Mid-yellow orange sandy silt clay	1.30	2.30	0.10	35.86	0.00	3	LIA/ER

Context No	Trench	Interpretation	Description	N-S (m)	E-W (m)	Depth (m)	High (m OD)	Low (m OD)	Phase	Prov date
180	Area 1	Fill of [181]	Mottled mid-brown orange silt clay	1.30	2.30	0.15	35.86	0.00	3	LIA/ER
181	Area 1	Pit	Ovoid, concave sides to concave base	1.30	2.30	0.25	35.86	35.57	3	LIA/ER
182	Area 1	Fill of [183]	Grey brown silt clay	1.00	0.68	0.54	36.37	0.00	4	LIA/ER
183	Area 1	Ditch	Linear, straight sides to flat base	1.00	0.68	0.54	36.37	35.82	4	LIA/ER
190	Area 1	Fill of [149]	Mid-grey brown silt clay	2.40	3.60	0.25	36.21	0.00	4	LIA/ER
191	Area 1	Fill of [147]	Dark grey brown silt clay	3.60	0.60	0.25	36.34	0.00	4	LIA/ER
192	Area 1	Fill of [194]	Mid-grey brown silt clay	0.55	1.60	0.07	36.47	0.00	4	LIA/ER
193	Area 1	Fill of [194]	Mid-grey brown silt clay	0.65	2.20	0.23	36.38	0.00	4	LIA/ER
194	Area 1	Ditch	Linear, Straight sides to concave base	0.65	2.20	0.30	36.46	36.14	4	LIA/ER
195	Area 1	Fill of [196]	Mottled orange brown silt clay	1.10	2.90	0.45	35.84	0.00	3	LIA/ER
196	Area 1	?Ditch	Sub-circular, straight sides to concave base	1.10	2.90	0.55	35.84	35.27	3	LIA/ER
197	Area 1	Fill of [198]	Grey brown silt clay	2.06	1.00	0.53	36.31	0.00	4	LIA/ER
198	Area 1	Ditch	Linear, straight sides to flat base	1.00	2.06	0.53	36.31	35.78	4	LIA/ER
201	Area 1	Fill of [202]	Grey brown silt clay	1.00	1.90	0.50	38.12	0.00	3	LIA/ER
202	Area 1	Ditch	Linear, straight sides to concave base	1.00	18.60	0.50	38.12	37.52	3	LIA/ER
203	Area 1	Fill of [115]	Mid-brown orange silt clay	1.10	1.67	0.40	35.78	0.00	3	LIA/ER
204	Area 1	Fill of [202]	Grey brown silt clay	1.00	1.50	0.15	38.00	0.00	3	LIA/ER
205	Area 1	Fill of [115]	Mid-orange brown silt clay	1.20	1.40	0.26	35.72	0.00	3	LIA/ER
206	Area 1	Fill of [207]	Mid-brown orange silt clay	5.60	2.40	0.50	35.91	0.00	2	LBA/EIA
207	Area 1	?Ditch	Linear, straight sides to concave base	8.70	2.40	0.50	35.91	35.10	2	LBA/EIA

Context No	Trench	Interpretation	Description	N-S (m)	E-W (m)	Depth (m)	High (m OD)	Low (m OD)	Phase	Prov date
208	Area 1	Natural subsoil	Yellow brown silt clay	0.00	0.00	0.00	0.00	0.00	1	Natural
209	Area 1	Fill of [202]	Grey brown silt clay	1.00	18.60	0.24	37.96	0.00	3	LIA/ER
222	Area 1	Fill of [223]	Mid-brown orange silt clay	1.60	1.20	0.60	35.66	0.00	2	LBA/EIA
223	Area 1	?Ditch	Linear, straight sides to concave base	10.55	1.20	0.60	35.84	35.10	2	LBA/EIA
224	Area 1	Fill of [225]	Light greyish blue silty clay	1.20	1.00	0.28	35.69	0.00	3	LIA/ER
225	Area 1	?Pit	Sub-circular, concave sides to flat base	1.20	1.00	0.28	35.69	35.44	3	LIA/ER
226	Area 1	Fill of [207]	Light grey brown silt clay	2.94	1.00	0.67	35.68	0.00	2	LBA/EIA
227	Area 1	Fill of [228]	Mottled mid-orange brown silt clay	2.45	1.35	0.35	35.84	0.00	3	LIA/ER
228	Area 1	?Ditch	Linear, straight sides to concave base	5.15	1.35	0.35	35.84	35.27	3	LIA/ER
229	Area 1	Fill of [230]	Pale grey brown clay silt	10.00	1.60	0.65	36.18	0.00	4	LIA/ER
230	Area 1	Ditch	Curvilinear, concave sides to concave base	10.00	1.60	0.65	36.18	35.47	4	LIA/ER
231	Area 1	Fill of [230]	Pale grey brown clay silt	10.00	1.60	0.65	0.00	0.00	4	LIA/ER
232	Area 1	Fill of [234]	Grey orange yellow silt clay	1.78	2.10	0.34	36.39	0.00	3	LIA/ER
233	Area 1	Fill of [234]	Mid-brown orange silt clay	2.10	1.50	0.24	36.20	0.00	3	LIA/ER
234	Area 1	Ditch	Linear, concave sides to concave base	1.80	30.60	0.70	36.50	35.83	3	LIA/ER
235	Area 1	Fill of [223]	Mid-orange brown silt clay	1.80	2.10	0.45	35.84	0.00	2	LBA/EIA
236	Area 1	Fill of [237]	Mid-brown grey silt clay	3.64	0.54	0.20	36.34	0.00	4	LIA/ER
237	Area 1	Gully	Linear, concave sides to concave base	3.64	0.54	0.20	36.34	36.13	4	LIA/ER
238	Area 1	Fill of [239]	Mid-reddish brown grey silt clay	1.20	1.66	0.38	36.16	0.00	2	LBA/EIA
239	Area 1	Pit	Sub-circular, concave sides to concave base	1.20	1.66	0.38	36.16	35.96	2	LBA/EIA

Context No	Trench	Interpretation	Description	N-S (m)	E-W (m)	Depth (m)	High (m OD)	Low (m OD)	Phase	Prov date
242	Area 1	Fill of [228]	Light orange brown silt clay	1.06	1.60	0.42	35.70	0.00	3	LIA/ER
243	Area 1	Fill of [244]	Light yellow brown silt clay	3.90	1.40	0.54	36.19	0.00	3	LIA/ER
244	Area 1	Ditch	Linear, concave sides to concave base	1.40	30.60	0.54	36.22	35.46	3	LIA/ER
245	Area 1	Fill of [246]	Light yellow brown silt clay	10.00	1.40	0.85	36.17	0.00	4	LIA/ER
246	Area 1	Ditch	Linear, concave sides to concave base	10.00	1.40	0.85	36.14	35.29	4	LIA/ER
247	Area 1	Fill of [248]	Mottled mid grey brown silt clay	2.24	1.01	0.35	36.41	0.00	3	LIA/ER
248	Area 1	?Pit	Sub-ovoid, Concave sides to flat base	2.24	1.01	0.35	36.41	36.01	3	LIA/ER
249	Area 1	Fill of [207]	Mid-orange brown silt clay	8.70	2.20	0.45	35.79	0.00	2	LBA/EIA
250	Area 1	Fill of [202]	Mid-orange grey brown silt clay	0.84	2.24	0.15	38.05	0.00	3	LIA/ER
251	Area 1	Fill of [252]	Light grey brown silt clay	1.46	1.64	0.16	36.44	0.00	1	Natural
252	Area 1	Natural feature	Sub-circular, irregular sides to flat base	1.46	1.64	0.16	36.44	36.25	1	Natural
253	Area 1	Fill of [254]	Light grey brown silt clay	0.94	0.56	0.18	36.39	0.00	3	LIA/ER
254	Area 1	Pit	Sub-rectangular, concave sides to concave base	0.94	0.56	0.18	36.39	36.21	3	LIA/ER
255	Area 1	Fill of [256]	Mottled mid-red brown grey silt clay	5.76	1.05	0.46	36.32	0.00	3	LIA/ER
256	Area 1	Ditch	Linear, concave sides to concave base	15.98	1.05	0.46	36.55	35.76	3	LIA/ER
257	Area 1	Fill of [258]	Mid-orange brown grey silt clay	2.84	1.44	0.49	37.21	0.00	5	P.Med
258	Area 1	Pit	Sub-rectangular, concave sides to flat base	2.84	1.44	0.49	37.21	36.72	5	P.Med
259	Area 1	Fill of [260]	Mid-yellow brown silt clay	1.64	1.77	0.36	37.36	0.00	1	Natural
260	Area 1	Natural feature	Circular, concave sides to flat base	1.64	1.77	0.36	37.36	37.00	1	Natural

Context No	Trench	Interpretation	Description	N-S (m)	E-W (m)	Depth (m)	High (m OD)	Low (m OD)	Phase	Prov date
261	Area 1	Fill of [262]	Dark orange brown silt clay	2.64	0.74	0.10	37.34	0.00	1	Natural
262	Area 1	Natural feature	Curvilinear, concave sides to irregular base	2.64	0.74	0.10	37.34	37.14	1	Natural
263	Area 1	Fill of [234]	Light grey orange yellow silt clay	1.10	1.15	0.47	36.45	0.00	3	LIA/ER
264	Area 1	Fill of [234]	Mid-brown orange silt clay	0.90	1.15	0.20	36.18	0.00	3	LIA/ER
265	Area 1	Fill of [266]	Mottled yellow brown silt clay	2.48	2.72	0.40	36.16	0.00	1	Natural
266	Area 1	Natural feature	Circular, straight sides to flat base	2.48	2.72	0.40	36.17	35.78	1	Natural
267	Area 1	Fill of [244]	Light yellow brown silt clay	1.40	30.60	0.54	36.27	0.00	3	LIA/ER
268	Area 1	Fill of [256]	Mottled mid-grey brown silt clay	5.76	0.88	0.31	36.47	0.00	3	LIA/ER
269	Area 1	Fill of [244]	Yellow brown silt clay	1.40	3.90	0.54	36.22	0.00	3	LIA/ER
270	Area 1	Fill of [246]	Yellow brown silt clay	5.20	1.40	0.79	36.14	0.00	4	LIA/ER
271	Area 1	Fill of [256]	Mid-orange grey brown silt clay	1.10	0.46	0.20	36.34	0.00	3	LIA/ER
272	Area 1	Fill of [256]	Mid-orange grey brown silt clay	1.04	0.50	0.16	36.51	0.00	3	LIA/ER
273	Area 1	Fill of [274]	Blue grey silt clay	0.82	0.94	0.43	36.25	0.00	4	LIA/ER
274	Area 1	Posthole	Circular, Concave sides to concave base	0.82	0.94	0.43	36.25	35.82	4	LIA/ER
156	Area 2	Gully	Linear, convex sides to flat base	24.30	0.55	0.10	40.11	39.77	P.Med	5
157	Area 2	Fill of [156]	Mid-brown grey silt clay	24.30	0.55	0.10	40.11	39.82	P.Med	5
158	Area 2	Natural	Mid-brown yellow silt clay	0.00	0.00	0.00	0.00	0.00	Natural	1
163	Area 2	Fill of [164]	Pale grey silt clay	0.80	0.43	0.08	39.99	0.00	LBA/EIA	2
164	Area 2	?Pit	Ovoid, concave sides to concave base	0.80	0.43	0.08	39.99	39.91	LBA/EIA	2
165	Area 2	Fill of [166]	Pale grey silt clay	0.68	0.55	0.07	39.98	0.00	LBA/EIA	2
166	Area 2	?Pit	Ovoid, concave sides to concave base	0.68	0.55	0.07	39.98	39.91	LBA/EIA	2

Context No	Trench	Interpretation	Description	N-S (m)	E-W (m)	Depth (m)	High (m OD)	Low (m OD)	Phase	Prov date
167	Area 2	Fill of [168]	Pale grey silt clay	0.45	0.34	0.06	39.93	0.00	LBA/EIA	2
168	Area 2	?Pit	Circular, concave sides to concave base	0.45	0.34	0.06	39.93	39.87	LBA/EIA	2
169	Area 2	Fill of [170]	Pale grey silt clay	0.41	0.41	0.06	39.92	0.00	LBA/EIA	2
170	Area 2	?Pit	Circular, concave sides to flat base	0.41	0.41	0.06	39.92	39.86	LBA/EIA	2
171	Area 2	Fill of [172]	Pale grey silt clay	0.40	0.35	0.06	39.88	0.00	LBA/EIA	2
172	Area 2	?Pit	Irregular, concave sides to irregular base	0.40	0.35	0.06	39.88	39.82	LBA/EIA	2
173	Area 2	Fill of [174]	Mid-grey silt clay	0.46	2.00	0.10	39.93	0.00	LBA/EIA	2
174	Area 2	Linear	Sub-rectangular, concave sides to concave base	0.46	2.00	0.10	39.93	39.83	LBA/EIA	2
175	Area 2	Fill of [176]	Mid-grey silt clay	0.66	0.54	0.13	40.02	0.00	LBA/EIA	2
176	Area 2	?Pit	Circular, concave sides to concave base	0.66	0.54	0.13	40.02	39.89	LBA/EIA	2
177	Area 2	Fill of [178]	Mid-grey silt clay	0.34	0.46	0.09	40.18	0.00	LBA/EIA	2
178	Area 2	Posthole	Sub-circular, concave sides to concave base	0.34	0.46	0.09	40.18	40.09	LBA/EIA	2
184	Area 2	Fill of [185]	Dark grey silt clay and charcoal	0.38	0.52	0.10	40.32	0.00	LBA/EIA	2
185	Area 2	Small pit	Sub-circular, vertical sides to irregular base	0.38	0.52	0.10	40.32	40.22	LBA/EIA	2
199	Area 2	Fill of [200]	Pale grey silt clay	2.74	1.00	0.13	40.34	0.00	LBA/EIA	2
200	Area 2	?Pit	Rectangular, concave sides to irregular base	2.74	1.00	0.13	40.34	39.30	LBA/EIA	2
210	Area 2	Gully	Linear, concave sides to flat base	2.50	0.50	0.15	39.95	39.70	LBA/EIA	2
211	Area 2	Fill of [210]	Mid-brown grey silt clay	2.50	0.50	0.15	39.95	0.00	LBA/EIA	2
212	Area 2	Gully	Linear, concave sides to flat	5.50	0.50	0.10	40.01	39.63	P.Med	5

Context No	Trench	Interpretation	Description	N-S (m)	E-W (m)	Depth (m)	High (m OD)	Low (m OD)	Phase	Prov date
			base							
213	Area 2	Fill of [212]	Mid-brown grey silt clay	5.50	0.50	0.10	40.01	0.00	P.Med	5
218	Area 2	Natural feature	Irregular, concave sides to irregular base	1.90	1.60	0.10	39.82	39.71	Natural	5
219	Area 2	Fill of [218]	Mid-brown grey silt clay	1.90	1.60	0.10	39.82	0.00	Natural	5
214	Area 3	Fill of [215]	Light orange yellow silt clay	2.20	1.10	0.10	37.85	0.00	Natural	1
215	Area 3	Natural feature	Irregular, concave sides to concave base	2.20	1.10	0.10	37.85	37.70	Natural	1
216	Area 3	Fill of [217]	Light orange yellow silt clay	1.50	1.20	0.30	38.02	0.00	LBA/EIA	2
217	Area 3	Ditch	Linear, concave sides to concave base	1.50	1.20	0.30	38.02	37.79	LBA/EIA	2
220	Area 3	Fill of [221]	Light orange yellow silt clay	0.80	0.70	0.22	38.05	0.00	LBA/EIA	2
221	Area 3	?Ditch	Linear?, concave sides to concave base	0.80	0.70	0.22	38.05	37.92	LBA/EIA	2
275	Area 3	Natural	Mid orange brown silt clay	0.00	0.00	0.00	0.00	0.00	Natural	1
276	Area 4	fill of [276]	Light yellow brown silt clay	1.10	1.05	0.30	36.07	35.44	LIA/ER	3
277	area 4	Ditch	Linear, concave sides to concave base	29.00	1.10	0.35	36.48	35.44	LIA/ER	4
278	Area 4	Fill of [277]	Light yellow brown silt clay	1.05	1.10	0.30	36.07	0.00	LIA/ER	4
291	Area 4	Subsoil	Mid orange brown silt clay	0.00	0.00	0.40	0.00	0.00	P.Med	5
292	Area 4	natural clay	Mid orange brown silt clay	0.00	0.00	0.00	41.10	40.06	Natural	1
419	Area 4	fill of [420]	Dark grey silt clay	1.10	0.80	0.20	36.09	35.38	LIA/ER	4
420	Area 4	Ditch	Linear, concave sides to concave base	15.20	0.80	0.20	36.25	35.38	LIA/ER	4
421	Area 4	fill of [422]	Yellow grey silt clay	1.60	2.14	0.37	36.33	35.96	LIA/ER	3
422	Area 4	Pit	Sub-circular, concave sides to flat base	1.60	2.14	0.37	36.33	35.96	LIA/ER	3
425	Area 4	Fill of [426]	dark yellow brown silt clay	1.10	0.85	0.60	36.12	35.52	LIA/ER	3

Context No	Trench	Interpretation	Description	N-S (m)	E-W (m)	Depth (m)	High (m OD)	Low (m OD)	Phase	Prov date
426	Area 4	Ditch	Linear, concave sides to concave base	20.60	0.85	0.60	36.42	35.52	LIA/ER	3
429	Area 4	fill of [431]	Mid orange brown silt clay	1.00	1.64	0.26	36.31	35.74	LIA/ER	3
430	Area 4	fill of [431]	Mottled dark orange brown silt clay	1.00	1.64	0.50	36.31	36.02	LIA/ER	3
431	Area 4	Pit	Sub-circular, concave sides to flat base	1.00	1.64	0.55	36.31	35.74	LIA/ER	3
432	Area 4	fill of [434]	Yellow brown silt clay	1.28	0.70	0.14	36.10	35.96	LIA/ER	3
433	Area 4	fill of [434]	Blackish brown silty clay	0.76	0.30	0.08	35.96	35.92	LIA/ER	3
434	Area 4	Cremation	Circular,stepped sides to concave base	1.28	0.70	0.37	36.08	35.72	LIA/ER	3
435	Area 4	fill of [277]	Mid orange yellow silt clay	1.00	1.18	0.32	36.34	35.98	LIA/ER	4
436	Area 4	fill of [420]	Mid grey blue silt clay	1.00	0.58	0.25	36.25	36.02	LIA/ER	4
437	Area 4	fill of [438]	Brown grey silt clay	3.66	0.86	0.22	35.91	35.88	LIA/ER	4
438	Area 4	Ditch	Linear, concave sides to concave base	3.66	0.74	0.30	35.89	35.67	LIA/ER	4
439	Area 4	fill of [420]	Grey brown silt clay	0.70	0.74	0.16	35.92	35.68	LIA/ER	4
441	Area 4	fill of [434]	Dark yellow brown silt clay	1.00	0.60	0.15	35.87	35.72	LIA/ER	4
442	Area 4	fill of [444]	Mottled dark orange brown silt clay	2.00	1.80	0.22	36.16	35.66	LIA/ER	3
443	Area 4	fill of [444]	Mottled mid orange brown silt clay	2.00	1.80	0.38	36.06	36.04	LIA/ER	3
444	Area 4	Pit	Sub-circular, concave sides to flat base	1.00	1.64	0.58	36.16	35.66	LIA/ER	3
445	Area 4	fill of [446]	Greyish mid-brown silt clay	13.00	1.30	0.41	36.05	35.59	LBA/EIA	3
446	Area 4	Ditch	Linear, concave sides to concave base	13.00	1.30	0.41	36.05	35.59	LBA/EIA	3
447	Area 4	fill of [448]	Greyish mid-brown silt clay	13.00	1.34	0.54	35.96	35.41	LBA/EIA	3

Context No	Trench	Interpretation	Description	N-S (m)	E-W (m)	Depth (m)	High (m OD)	Low (m OD)	Phase	Prov date
448	Area 4	Ditch	Linear, concave sides to concave base	13.00	1.34	0.54	35.96	35.42	LBA/EIA	3
449	Area 4	fill of [426]	dark yellow brown silt clay	1.00	0.70	0.35	35.89	35.53	LBA/EIA	2
450	Area 4	fill of [451]	Mottled mid orange brown silt clay	1.70	1.70	0.00	35.99	35.96	LIA/ER	3
451	Area 4	Pit	Sub-circular - unexcavated	1.70	1.70	0.00	35.99	35.96	LIA/ER	3
452	Area 4	fill of [453]	Mottled mid orange brown silt clay	1.00	1.25	0.00	36.07	0.00	LIA/ER	3
453	Area 4	Pit	Sub-circular - unexcavated	1.00	1.25	0.00	36.07	0.00	LIA/ER	3
454	Area 4	fill of [455]	Mottled mid orange brown silt clay	0.90	0.85	0.00	36.02	0.00	LIA/ER	3
455	Area 4	Pit	Sub-circular - unexcavated	0.90	0.85	0.00	36.02	0.00	LIA/ER	3
456	Area 4	fill of [457]	Mottled mid orange brown silt clay	0.80	0.80	0.00	36.07	0.00	LIA/ER	3
457	Area 4	Pit	Sub-circular - unexcavated	0.80	0.80	0.00	36.07	0.00	LIA/ER	3
458	Area 4	fill of [459]	Mottled mid orange brown silt clay	1.10	1.40	0.00	36.32	0.00	LIA/ER	3
459	Area 4	Pit	Sub-circular, unexcavated	1.10	1.40	0.00	36.32	36.25	LIA/ER	3
460	Area 4	fill of [461]	Firm mid yellow brown silt-clay	1.45	25.00	0.54	35.64	35.12	LBA/EIA	2
461	Area 4	Ditch	Linear, concave sides to concave base	1.45	20.00	0.54	35.64	35.12	LBA/EIA	2
462	Area 4	fill of [464]	Light grey yellow brown silt clay	1.80	1.00	0.15	35.98	35.77	LBA/EIA	2
463	Area 4	fill of [464]	Mid-yellow brown silt clay	1.80	1.00	0.45	35.98	35.48	LBA/EIA	2
464	Area 4	Ditch	Linear, concave sides to concave base	1.80	12.60	0.50	35.98	35.45	LBA/EIA	2
465	Area 4	fill of [464]	Light grey yellow brown silt clay	1.80	1.00	0.20	35.90	35.77	LBA/EIA	2
466	Area 4	fill of [464]	Mid-orange brown silt clay	1.80	1.00	0.55	35.90	35.45	LBA/EIA	2
279	Area 5	fill of [280]	Mottled mid-grey brown silt clay	1.50	0.20	0.12	40.47	0.00	LIA/ER	3

Context No	Trench	Interpretation	Description	N-S (m)	E-W (m)	Depth (m)	High (m OD)	Low (m OD)	Phase	Prov date
280	Area 5	Ditch	Concave sides to concave base	10.40	0.55	0.35	40.51	40.17	LIA/ER	3
281	Area 5	fill of [282]	Mottled mid brown grey silt clay	1.55	1.20	0.20	40.77	40.55	LIA/ER	3
282	Area 5	Pit	Sub-circular, concave sides to concave base	1.55	1.20	0.20	40.77	40.55	LIA/ER	3
283	Area 5	fill of [284]	Mottled light brown grey silt clay	0.90	0.90	0.20	40.78	40.58	LIA/ER	3
284	Area 5	Pit	Sub-circular, concave sides to concave base	0.90	0.90	0.20	40.78	40.58	LIA/ER	3
285	Area 5	fill of [286]	Mottled light brown grey silt clay	0.90	0.70	0.15	40.83	40.65	LBA/EIA	2
286	Area 5	Pit	Sub-circular, concave sides to concave base	0.90	0.70	0.15	40.83	40.65	LBA/EIA	2
287	Area 5	fill of [288]	Dark brown black silt clay	1.20	45.00	0.39	41.71	41.32	P.Med	5
288	Area 5	Ditch	Linear, straight sides to concave base	1.20	45.00	0.39	41.71	41.32	P.Med	5
289	Area 5	Subsoil	Mid-orange brown silt clay	0.00	0.00	0.40	0.00	0.00	P.Med	5
290	Area 5	natural clay	Mid orange brown silt clay	0.00	0.00	0.00	36.5	35.7	Natural	1
293	Area 5	fill of [294]	Mottled mid grey silt clay	1.15	0.35	0.20	40.09	0.00	LIA/ER	3
294	Area 5	Ditch	Linear, concave sides to concave base	5.70	0.35	0.25	40.12	39.80	LIA/ER	3
295	Area 5	fill of [280]	Mottled mid-grey brown silt clay	1.00	0.55	0.35	40.50	0.00	LBA/EIA	2
296	Area 5	fill of [294]	Dark grey brown silt clay	1.10	0.40	0.25	40.07	0.00	LBA/EIA	2
297	Area 5	fill of [353]	Yellowish dark brown silt clay	0.40	6.68	0.12	40.77	40.47	LBA/EIA	2
298	Area 5	fill of [353]	Yellowish dark brown silt clay	6.68	0.56	0.12	40.70	40.47	LBA/EIA	2
299	Area 5	fill of [300]	Mid-brown silt clay	0.80	5.40	0.14	40.85	40.71	P.Med	5
300	Area 5	Ditch	Linear , straight sides to flat base	0.80	5.40	0.14	40.85	40.71	P.Med	5
301	Area 5	fill of [302]	Grey brown silt clay	0.60	0.54	0.20	40.71	40.52	LBA/EIA	2
302	Area 5	Pit	Circular, straight sides to flat base	0.60	0.54	0.20	40.71	40.52	LBA/EIA	2

Context No	Trench	Interpretation	Description	N-S (m)	E-W (m)	Depth (m)	High (m OD)	Low (m OD)	Phase	Prov date
303	Area 5	fill of [304]	Yellow brown silt clay	0.40	3.20	0.15	40.67	40.53	LBA/EIA	2
304	Area 5	Ditch	Linear, concave sides to concave base	3.20	0.40	0.15	40.67	40.53	LBA/EIA	2
305	Area 5	fill of [306]	Mottled light brown grey silt clay	0.90	0.70	0.15	40.78	40.63	LBA/EIA	2
306	Area 5	Pit	Sub-circular, concave sides to concave base	0.90	0.70	0.15	40.78	40.63	LBA/EIA	2
307	Area 5	fill of [308]	Mottled light brown grey silt clay	0.50	0.50	0.10	40.77	40.68	LBA/EIA	2
308	Area 5	Pit	Sub-circular, concave sides to concave base	0.50	0.50	0.10	40.77	40.68	LBA/EIA	2
309	Area 5	fill of [310]	Mottled mid-orange brown grey silt clay	0.70	0.80	0.20	40.78	40.66	LBA/EIA	2
310	Area 5	Pit	Sub-circular, concave sides to concave base	0.70	0.80	0.20	40.78	40.66	LBA/EIA	2
311	Area 5	Fill of [312]	Light yellow brown sandy clay	1.06	0.79	0.23	41.01	0.00	LBA/EIA	2
312	Area 5	Pit	Sub-rectangular, concave sides to flat base	1.06	0.79	0.23	41.01	40.81	LBA/EIA	2
313	Area 5	fill of [313]	Dark grey brown silt clay	0.50	0.84	0.20	40.71	0.00	LBA/EIA	2
314	Area 5	Pit	Sub-circular, straight sides to concave base	0.84	0.64	0.54	41.03	40.05	LBA/EIA	2
315	Area 5	Fill of [314]	Yellow brown clay	0.50	0.80	0.30	41.03	41.00	LBA/EIA	2
316	Area 5	fill of [317]	Dark grey brown silty clay gravel	2.60	1.70	0.18	40.70	40.41	P-med	5
317	Area 5	Pit	Ovoid, concave sides to flat base	2.60	1.70	0.18	40.60	40.58	P-med	5
318	Area 5	fill of [319]	Mottled mid orange grey silt clay	0.60	0.60	0.10	40.76	40.65	LBA/EIA	2
319	Area 5	Pit	Sub-circular, concave sides to concave base	0.60	0.60	0.10	40.76	40.65	LBA/EIA	2

Context No	Trench	Interpretation	Description	N-S (m)	E-W (m)	Depth (m)	High (m OD)	Low (m OD)	Phase	Prov date
320	Area 5	fill of [321]	Mid-orange brown grey silt clay	0.40	0.40	0.15	40.69	40.75	LBA/EIA	2
321	Area 5	Pit	Sub-circular, concave sides to concave base	0.60	0.60	0.15	40.69	40.76	LBA/EIA	2
322	Area 5	fill of [323]	Mid grey brown silt clay	1.15	0.75	0.35	40.20	40.15	LIA/ER	3
323	Area 5	Ditch	Linear, concave to concave base	8.60	0.90	0.35	40.31	39.77	LIA/ER	3
324	Area 5	fill of [325]	Grey brown silt clay	0.60	0.68	0.19	41.02	0.00	LBA/EIA	2
325	Area 5	Pit	Sub-circular, concave sides to concave base	0.60	0.68	0.19	40.99	40.84	LBA/EIA	2
326	Area 5	fill of [327]	Light grey brown silt clay	0.90	0.83	0.36	40.61	40.25	LBA/EIA	2
327	Area 5	Pit	Circular, straight sides to flat base	0.90	0.83	0.36	40.61	40.25	LBA/EIA	2
328	Area 5	fill of [329]	Light blue grey sandy clay	1.56	1.30	0.43	40.81	0.00	LBA/EIA	2
329	Area 5	Pit	Circular, vertical sides to flat base	1.56	1.30	0.43	40.81	40.38	LBA/EIA	2
330	Area 5	fill of [331]	Mid-yellow grey sandy clay	0.74	0.70	0.18	40.83	0.00	LBA/EIA	2
331	Area 5	Pit	Sub-circular, concave sides to concave base	0.74	0.70	0.18	40.83	40.65	LBA/EIA	2
332	Area 5	fill of [333]	Mid-red brown grey sandy clay	1.00	0.77	0.11	40.82	0.00	LBA/EIA	2
333	Area 5	Pit	Sub-circular, concave sides to flat base	1.00	0.70	0.11	40.82	40.71	LBA/EIA	2
334	Area 5	fill of [323]	Mid grey brown silt clay	2.15	0.90	0.20	40.31	40.23	LBA/EIA	2
335	Area 5	fill of [336]	Stone in mid orange brown silty clay matrix	0.68	0.30	0.11	41.11	41.00	Natural	1
336	Area 5	Pit	Irregular, concave sides to concave base	0.80	0.40	0.20	41.10	40.97	Natural	1
337	Area 5	fill of [338]	Mid-grey brown silt clay	0.28	0.46	0.12	41.04	0.00	P.med	5
338	Area 5	Pit	Circular, concave sides to	0.28	0.46	0.12	41.03	40.91	P.Med	5

Context No	Trench	Interpretation	Description	N-S (m)	E-W (m)	Depth (m)	High (m OD)	Low (m OD)	Phase	Prov date
			concave base							
339	Area 5	fill of [340]	Mottled mid brown grey silt clay	0.80	0.70	0.20	40.77	40.61	LBA/EIA	2
340	Area 5	Pit	Sub-circular, concave sides to concave base	0.80	0.70	0.20	40.77	40.61	LBA/EIA	2
341	Area 5	fill of [342]	Dark brown silt clay	2.00	1.50	0.28	40.68	40.66	LBA/EIA	2
342	Area 5	Pit	Sub-circular, straight sides to flat base	2.00	1.50	0.55	40.68	40.21	LBA/EIA	2
343	Area 5	fill of [344]	Grey brown silt clay	0.36	0.34	0.12	41.06	40.95	P.Med	5
344	Area 5	Posthole	Circular concave sides to concave base	0.36	0.34	0.14	41.04	40.95	P.Med	5
345	Area 5	fill of [346]	Yellow brown silt clay	0.36	1.80	0.14	40.79	40.61	LBA/EIA	2
346	Area 5	Linear cut	Linear, concave sides to concave base	0.36	1.80	0.14	40.79	40.61	LBA/EIA	2
347	Area 5	fill of [348]	Grey brown silt clay	0.60	0.86	0.16	41.03	41.00	P.Med	5
348	Area 5	Pit	Ovoid, concave sides to concave base	0.60	0.86	0.16	41.03	40.87	P.Med	5
349	Area 5	fill of [342]	Dark orange brown clay	2.00	1.50	0.30	40.75	40.58	LBA/EIA	2
350	Area 5	fill of [351]	Yellow brown clay silt	0.25	0.30	0.08	40.64	40.60	LBA/EIA	2
351	Area 5	Posthole	Sub-circular, concave sides to flat base	0.25	0.30	0.08	40.64	40.60	LBA/EIA	2
352	Area 5	fill of [353]	Yellowish dark brown silt clay	6.68	0.56	0.12	40.70	40.47	LBA/EIA	2
353	Area 5	Ditch	Linear concave sides to concave base	6.68	0.56	0.12	40.70	40.47	LBA/EIA	2
354	Area 5	fill of [355]	Yellow mid-brown silt clay	0.82	0.84	0.14	40.72	40.46	LBA/EIA	2
355	Area 5	Pit	Circular, concave sides to concave base	0.82	0.84	0.14	40.72	40.46	LBA/EIA	2
356	Area 5	fill of [357]	Dark brown grey silt clay	0.38	0.28	0.14	40.77	40.72	LBA/EIA	2
357	Area 5	Pit	Sub-circular, straight sides to	0.38	0.28	0.14	40.77	40.66	LBA/EIA	2

Context No	Trench	Interpretation	Description	N-S (m)	E-W (m)	Depth (m)	High (m OD)	Low (m OD)	Phase	Prov date
			flat base							
358	Area 5	fill of [359]	Grey mid-brown silt clay	1.40	0.58	0.09	40.73	40.65	LBA/EIA	2
359	Area 5	Pit	Ovoid, concave sides to flat base	1.14	0.58	0.09	40.73	40.65	LBA/EIA	2
360	Area 5	fill of [361]	Mid-brown silt clay	0.61	0.60	0.08	40.76	40.67	LBA/EIA	2
361	Area 5	Pit	Circular, concave sides to flat base	0.64	0.60	0.08	40.76	40.67	LBA/EIA	2
362	Area 5	fill of [363]	Yellow brown silt clay	0.74	0.50	0.09	40.73	40.64	LBA/EIA	2
363	Area 5	Pit	Ovoid, concave sides to flat base	0.74	0.50	0.09	40.73	40.64	LBA/EIA	2
364	Area 5	fill of [365]	Grey brown silt clay	0.22	0.21	0.11	40.74	40.63	LBA/EIA	2
365	Area 5	Posthole	Circular, concave sides to concave base	0.22	0.21	0.11	40.74	40.63	LBA/EIA	2
366	Area 5	fill of [367]	Yellow brown silt clay	0.94	0.97	0.25	40.68	40.43	LBA/EIA	2
367	Area 5	Pit	Circular, concave sides to concave base	0.91	0.97	0.25	40.68	40.43	LBA/EIA	2
368	Area 5	fill of [369]	Yellow light brown silt clay	0.84	1.02	0.20	40.69	40.49	LBA/EIA	2
369	Area 5	Pit	Ovoid, concave sides to concave base	0.84	1.02	0.20	40.69	40.49	LBA/EIA	2
370	Area 5	fill of [371]	Stone in mid orange brown silty clay matrix	0.54	0.30	0.18	41.09	41.07	Natural	1
371	Area 5	Pit	Sub-rectangular, concave sides to concave base	0.46	0.14	0.18	41.10	41.04	Natural	1
372	Area 5	fill of [373]	Grey brown silt clay	0.64	0.58	0.12	41.08	41.04	LBA/EIA	2
373	Area 5	Pit	Sub-circular, concave sides to concave base	0.64	0.38	0.11	41.04	40.93	LBA/EIA	2
376	Area 5	fill of [377]	Dark grey blue silt clay	0.32	0.31	0.14	40.68	40.76	LBA/EIA	2
377	Area 5	Pit	Sub-circular, straight sides to	0.65	0.88	0.14	41.06	40.92	LBA/EIA	2

Context No	Trench	Interpretation	Description	N-S (m)	E-W (m)	Depth (m)	High (m OD)	Low (m OD)	Phase	Prov date
			uneven base							
378	Area 5	fill of [380]	Mottled dark blue grey silt clay	1.00	0.50	0.15	40.41	40.11	LIA/ER	3
379	Area 5	fill of [380]	Mid orange brown silt clay	1.00	1.00	0.40	40.41	40.11	LIA/ER	3
380	Area 5	Ditch	Linear, concave sides to concave base	15.60	1.00	0.40	40.57	40.11	LIA/ER	3
381	Area 5	fill of [380]	Mottled dark blue grey silt clay	1.00	0.50	0.15	40.57	40.42	LBA/EIA	2
382	Area 5	fill of [380]	Mid orange brown silt clay	1.00	0.85	0.25	40.57	40.29	LBA/EIA	2
383	Area 5	fill of [384]	Brown grey silt clay	0.24	0.24	0.05	40.94	0.00	LBA/EIA	2
384	Area 5	Pit	Sub-circular, concave sides to concave base	0.24	0.24	0.04	40.94	40.89	LBA/EIA	2
385	Area 5	fill of [386]	Brown grey silt clay	0.22	0.20	0.03	40.94	0.00	LBA/EIA	2
386	Area 5	Pit	Sub-circular, concave sides to concave base	0.22	0.20	0.05	40.94	40.88	LBA/EIA	2
387	Area 5	fill of [388]	Brown grey silt clay	0.20	0.20	0.11	40.88	0.00	LBA/EIA	2
388	Area 5	Pit	Sub-circular, concave sides to concave base	0.20	0.20	0.11	40.92	40.88	LBA/EIA	2
389	Area 5	fill of [390]	Mid yellow brown sandy clay	1.15	1.22	0.31	40.76	0.00	LBA/EIA	2
390	Area 5	Pit	Sub-circular, straight sides to uneven base	1.15	1.22	0.31	40.76	40.45	LBA/EIA	2
391	Area 5	fill of [392]	Greyish light brown silt clay	1.00	0.52	0.16	40.78	40.59	LBA/EIA	2
392	Area 5	Ditch	Linear, concave sides to flat base	0.60	9.12	0.20	40.78	40.59	LBA/EIA	2
393	Area 5	fill of [380]	Mottled dark blue grey silt clay	1.00	0.40	0.15	40.42	40.30	LBA/EIA	2
394	Area 5	fill of [380]	Mid orange brown silt clay	1.00	0.65	0.20	40.41	40.20	LBA/EIA	2
395	Area 5	fill of [396]	Mid grey brown silt clay	0.20	0.16	0.10	40.60	40.58	LBA/EIA	2
396	Area 5	Pit	Sub-circular, straight sides to flat base	0.20	0.16	0.10	40.60	40.51	LBA/EIA	2
397	Area 5	fill of [398]	Dark grey brown silt clay	0.32	0.26	0.22	40.64	40.62	LBA/EIA	2

Context No	Trench	Interpretation	Description	N-S (m)	E-W (m)	Depth (m)	High (m OD)	Low (m OD)	Phase	Prov date
398	Area 5	Posthole	Sub- circular , straight sides to flat base	0.32	0.26	0.22	40.64	40.44	LBA/EIA	2
399	Area 5	fill of [400]	Yellow brown clay	1.30	1.16	0.28	41.10	41.05	LBA/EIA	2
400	Area 5	Pit	Sub-circular, concave sides to concave base	1.30	1.16	0.28	41.10	40.81	LBA/EIA	2
401	Area 5	Fill of [402]	Stone in mid orange brown silty clay matrix	0.70	0.24	0.24	40.93	40.85	Natural	1
402	Area 5	Pit	Irregular, concave sides to concave base	0.70	0.24	0.12	40.92	40.80	Natural	1
403	Area 5	fill of [404]	Dark blue grey black silt clay	0.36	0.31	0.18	40.57	0.00	LBA/EIA	2
404	Area 5	Pit	Circular, Straight sides to flat base	0.36	0.31	0.18	40.57	40.41	LBA/EIA	2
405	Area 5	fill of [406]	Mid-brown silt clay	2.40	0.80	0.00	40.32	0.00	Natural	5
406	Area 5	Pit	Ovoid, unexcavated	2.40	0.80	0.00	40.32	0.00	Natural	5
407	Area 5	fill of [408]	Dark grey clay silt	0.75	1.70	0.15	40.31	40.24	Natural	5
408	Area 5	Pit	Ovoid, unexcavated	0.75	1.70	0.15	40.31	40.18	Natural	5
409	Area 5	fill of [410]	Mid grey brown clay silt	1.60	1.80	0.20	40.32	40.24	LIA/ER	3
410	Area 5	Pit	Irregular, concave sides to flat base	1.60	1.80	0.20	40.33	40.16	LIA/ER	3
411	Area 5	fill of [412]	Mid grey brown clay silt	0.90	1.50	0.15	40.19	40.11	LBA/EIA	2
412	Area 5	Pit	Irregular, concave sides to flat base	0.90	1.50	0.15	40.20	40.09	LBA/EIA	2
413	Area 5	fill of [392]	Greyish light brown silt clay	0.42	1.00	0.12	40.67	40.59	LBA/EIA	2
414	Area 5	fill of [392]	Greyish light brown silt clay	0.65	1.00	0.17	40.72	40.57	LBA/EIA	2
415	Area 5	fill of [416]	Grey brown silt clay	0.26	0.38	0.10	40.68	40.59	LBA/EIA	2
416	Area 5	Posthole	Ovoid, concave sides to concave base	0.26	0.38	0.10	40.68	40.59	LBA/EIA	2
417	Area 5	fill of [418]	Grey brown silt clay	0.70	1.30	0.15	40.72	40.59	LIA/ER	3

Context No	Trench	Interpretation	Description	N-S (m)	E-W (m)	Depth (m)	High (m OD)	Low (m OD)	Phase	Prov date
418	Area 5	Ditch	Ovoid, concave sides to flat base	0.70	1.30	0.15	40.72	40.59	LIA/ER	3
423	Area 5	fill of [424]	Dark grey silt clay	4.80	1.70	0.00	0.00	0.00	P.Med	5
424	Area 5	Pit	Rectangular, unexcavated	4.80	1.70	0.00	0.00	0.00	P.Med	5

11 APPENDIX 3: PREHISTORIC POTTERY ASSESSMENT

By Mike Seager-Thomas

- 11.1 The prehistoric pottery assemblage from Harold Wood comprises 266 heavily weathered sherds with a weight of approximately 0.6 kilograms (Table 1). Sherds belonging to two first millennium BC pottery traditions can be distinguished within it.
- 11.2 The earlier comprise a suite of fine to coarse flint- and coarse flint and shell-tempered fabrics, associated both locally and further afield with the LBA to EIA post Deverel-Rimbury pottery tradition. Owing to the small size of the assemblage and the absence from it of diagnostic feature sherds it is not possible to date it with certainty within this period, although the overall range of fabric types is probably indicative a later, rather than earlier date — say around the end of the LBA. The bulk of the assemblage belongs to this period.
- 11.3 The later tradition is distinguished by the presence of grog, flint and grog, and sandy flint-tempered fabrics. While it is present in much earlier traditions locally, and an occasional component of first millennium BC traditions regionally, grog-tempering in the Thames Valley is most characteristic of the Late Iron Age, a view confirmed for the present assemblage by a feature sherd in a grog and flint-tempered fabric of a pre-Belgic Middle–Late Iron Age form (from context 334).
- 11.4 Except in so far as it confirms — yet again — the ubiquity of post Deverel-Rimbury activity in the region, the earlier group is of little interest; there are larger, better-preserved and therefore more informative assemblages from elsewhere in the region (at Redbridge for example and in the Lee Valley). Late Iron Age pottery by contrast is not well known locally (the present writer has seen no exact local analogue for the aforementioned feature sherd) and although the present assemblage is too small, too weathered and too poorly defined to make much of, it would be worth characterizing in more detail.

Locus	sherd qty	weight Gr	fabric(s)	diagnostics	pottery date
34	6	10	fine S or chaff & MCF	fabrics; very thick sherd in MCF	LBA/EIA & first millennium BC
100	3	2	MCF	fabric	LBA/EIA
108	1	1	MFQ	none — too small	first millennium BC
141	1	4	fine S or chaff	fabric	first millennium BC
144	6	2	SCF & G	fabrics	LBA/EIA & LIA
199	2	1	FMF	none — too small	prehistoric
216	5	10	M–MCF	fabric; very thin walls	LBA/EIA
238	1	1	MF	fabric	LBA/EIA
263	4	3	MCF	fabric	LBA/EIA
283	1	1	fine Q	fabric	LIA
296	1	1	U	none — too small	Not dated
301	6	10	MCF	fabric	LBA/EIA
303	3	10	FMF & MCF	fabrics; fingered, slightly out-turned rim of PDR closed-mouthed shouldered jar in FMF	LBA/EIA

Locus	sherd qty	weight Gr	fabric(s)	diagnostics	pottery date
305	3	9	FMF & (S)CFS	fabrics	LBA/EIA
318	5	20	MCF & (S)CF	fabrics	LBA/EIA
318	1	8	MF	fabric	LBA/EIA
324	5	3	FMF	fabric	LBA/EIA
328	1	5	MF	fabric; very thin walls	LBA/EIA
334	6	60	FF, FMF & (R)MCFG	fabrics; rim of later IA round shouldered jar in (R)MCFG	LBA/EIA & LIA
341	6	10	U, FMF, MF & MCF	fabrics; PDR-like fingertip impressed rim in MCF	LBA/EIA
361	1	1	FF	fabric	LBA/EIA
376 <33>	27	45	FF, FMF(?)S & MF	fabrics	LBA/EIA
391	1	3	MF	fabric; thin wall	LBA/EIA
403 <34>	158	305	MF & (S)CFS	fabrics	LBA/EIA
409	9	90	(S)MFQ, (R)MCFG, MCF & (S)CF	fabrics	LBA/EIA & LIA
411	1	1	FF	fabric	LBA/EIA
436	2	1	SG	fabric	LIA

Table 1: Prehistoric pottery from Harold Wood. Key: (S) = sparse; (R) = rare; FF = fine flint; FMF = fine to medium flint; MF = medium flint; MCF = medium to coarse flint; CF = coarse flint; G = grog-like inclusions; S = decalcified shell voids; Q coarse quartz sand; U = no visible inclusions.

12 APPENDIX 4: LITHICS ASSESSMENT

By Barry Bishop

12.1 Introduction

12.1.1 The investigations at the site resulted in the recovery of a small quantity of struck flint and unworked burnt stone. This report follows the methodology and objectives encapsulated in both MAP2 and MoRPHE (English Heritage 1991; 2006). Its aims are to quantify and describe the material, assess its significance and to recommend any further work required for the material to achieve its full research potential. All metrical information follows the methodology established by Saville (1980). A full catalogue detailing the material's distribution within individual contexts is presented in Table 1.

12.2 Burnt Stone

12.2.1 A total of 841g of burnt stone was recovered from 20 separate contexts representing 19 different features (Appendix L01). The stone predominantly comprised flint which included Tertiary pebbles, alluvial pebbles and thermally shattered nodules, along with a few pieces of quartzitic sandstone. All probably have their origin in the terrace gravels or glacial deposits as can be found in the area (Gibbard 1986). The stone had been burnt to varying degrees, suggesting that it had been caused through incidental incorporation into hearths rather than deliberately. It was present mostly in small quantities; only three features contained quantities greater than 100g; pits [200] an [342] and ditch [438] and even these only contained relatively small quantities most consistent with 'background waste' from general hearth use.

12.3 Struck Flint

12.3.1 In total eleven struck flints were recovered, comprising four decortication flakes, three flakes, one flake fragment and three retouched implements. These were recovered from ten contexts and eight separate elements, mostly singly with only three features (context [38], pit [200] and ditch [277]) producing two pieces (Appendix L01). All of the contexts have provisionally been dated to between the Late Bronze Age and Late Iron Age. No cores are present.

12.3.2 The assemblage is made from flint of a variety of colours including translucent grey and brown, opaque brown and mottled green and brown. Cortex is equally varied and includes weathered rough, smooth rolled and battered pieces. Thermal flaws are common. The raw materials were mostly likely to have been obtained from alluvial or glacio-fluvial deposits and are common in the vicinity (Gibbard 1986). The condition of the pieces is mostly good suggesting that they have experienced only minor post-depositional movement and are likely to have been recovered from close to where originally deposited. One piece, the flake fragment from ditch [277] is burnt.

12.3.3 The flakes are mostly short and thick with wide unmodified striking platforms, being typical of later second and first millennium flint working traditions. The retouched pieces include a split pebble from ditch [380] with possible retouch near its bulbar end, possibly used as a knife, and a distal end of a flake from ditch [230] with crude flaking removing its bulbar end resulting in a tool with a double notch. These are both expediently made and again are most typical of later prehistoric implements. The remaining retouched implement was recovered from ditch [207] and consists of the distal end of a

prismatic blade whose break was initiated by a small notch made on its left dorsal margin. It quite possibly represents an attempt at microlith manufacture using the micro-burin attempt although the characteristic oblique scar is absent. Contrasting with the rest of the assemblage this is almost certainly an earlier piece, most likely dating to the Mesolithic period.

12.4 Significance

12.4.1 The burnt stone is typical in quantity and distribution to that generated within prehistoric settlement contexts where hearths are constructed directly onto the ground surface. No concentrations of intensively burnt stone are present that could be suggestive of deliberate production and the assemblage most likely represents incidentally produced hearth debris. The struck flint was mostly expediently produced and small in quantity, typical of the occasional and ad hoc use of flint as found in later prehistoric settlements and field-systems (eg Young and Humphrey 1999). It is likely to be contemporary with the later prehistoric features recorded at the site although the assemblage is too small to further refine the suggested dating or to speculate on the precise roles it performed in the wider scheme of occupation at the site.

12.5 Recommendations

12.5.1 Although small the lithic assemblage does contribute to understandings of the prehistoric use of the site. No further analytical work is warranted but a brief description of the material should be included in any published account of the excavation, preferably alongside illustration of the three retouched pieces. The burnt flint, particularly details of its distribution, should also be mentioned in any published account.

12.6 Bibliography

- English Heritage 1991 Management of Archaeological Projects. Historic Buildings and Monuments Commission for England. London.
- English Heritage 2006 Management of Research Projects in the Historic Environment. English Heritage. Swindon
- Gibbard, P.L. 1986 Flint Gravels in the Quaternary of Southeast England. In: G. De C. Sieveking and M.B. Hart (Eds) *The Scientific Study of Flint and Chert*, 141-149. Cambridge University Press. Cambridge.
- Saville, A. 1980 On the measurement of struck flakes and flake tools. *Lithics* 1, 16-20.
- Young, R. and Humphrey, J. 1999 Flint Use in England after the Bronze Age: time for a re-evaluation? *Proceedings of the Prehistoric Society* 65, 231-242.

Table 1: Distribution of lithic material within individual contexts

Context	Feature	Decortication Flake	Squat Flake	Flake Fragment	Retouched	Burnt Stone (no.)	Burnt Stone (wt:g)	Colour	Cortex	Condition	Recortication	Date	Comments
167	P168					1	2						Lightly burnt flint
167	P168	1						Translucent Grey	Thermal	Good	None	Late	Possibly 'accidentally' made
199	P200					3	122						Burnt tertiary pebble and two frags
199	P200	1	1					Mottled greenish brown	Smooth	Good	None	Late	Both 'squat'
249	D207				1			Translucent Brown	None	Good	Milky	Meso	Distal end of a prismatic blade that broke across a small notch made on its LD. Possibly a failed micro-burin/microlith
285	P286					1	17						Heavily burnt flint
305	P306					1	9						Lightly burnt flint
309	P310					1	6						Heavily burnt flint
315	P/TT314					2	4						Tertiary pebble. Burnt deep red colour
320	P321					1	3						Lightly burnt flint
324	P325					4	62						Variably burnt flint
341	P342					10	146						Variably burnt includes angular shattered nodules, small pebbles

Context	Feature	Decortication Flake	Squat Flake	Flake Fragment	Retouched	Burnt Stone (no.)	Burnt Stone (wt:g)	Colour	Cortex	Condition	Recortication	Date	Comments
													including tertiary and a piece of quartzite
352	D353					1	8						Heavily burnt flint
381	D380					3	11						Variably burnt flint
382	D380					2	14						Heavily burnt flint
393	D380				1			Mottled greenish brown	Smooth	Good	None	Late	Split pebble with possible retouch near bulbar end
114	D115					1	7						Heavily burnt flint
276	D277		1					Translucent Brown	Smooth	Good	None	Late	Flake formed from very hard blow, SP has shattered
276	D277			1				Translucent Brown	Battered	Burnt	None	Undated	Small slightly burnt fragment
281	P282					11	57						Variably burnt includes angular shattered nodules, small pebbles and a piece of fine-grained quartzite
283	P284					1	4						Heavily burnt flint
409	P410		1					Opaque brown	Rough	Good	None	Late	small mis-hit flake
112	D113					2	19						Heavily burnt flint
229	D230				1			Mottled greenish brown	Smooth	Good	None	?Late	Distal end of a flake with crude flaking removing bulbar end and resulting in a double notched tool

Context	Feature	Decortication Flake	Squat Flake	Flake Fragment	Retouched	Burnt Stone (no.)	Burnt Stone (wt:g)	Colour	Cortex	Condition	Recortication	Date	Comments
437	D438					13	330						Variably burnt includes angular shattered nodules, small pebbles including tertiary and a piece of quartzite
316	TT317					1	6						Burnt quartzite
34	?					1	9						Heavily burnt flint
34	?	1						Translucent Brown	Rough	Good	None	Undated	Small chip
34	?	1						Opaque brown	Smooth	Slightly Abraded	None	Late	squat
38	?					1	5						Lightly burnt flint. Also large unburnt but thermally shattered chert cobble

13 APPENDIX 5: ENVIRONMENTAL REPORT

By Lisa Snape-Kennedy

13.1 INTRODUCTION

13.1.1 This report summarises the findings from the rapid assessment of bulk samples taken from contexts during two phases of excavation at Harrold Wood Hospital, London Borough of Havering (HWP-07). The aim of this environmental archaeological assessment is to; provide an overview of the contents of the bulk samples, determine the potential of the samples for understanding the general environmental context of the site, and to retrieve human bone from possible cremations which could not be clarified during excavation.

13.2 METHODOLOGY

13.2.1 18 bulk samples between 5-22 litres were process by Pre-Construct Archaeology Ltd using the flotation method (Kenward et al, 1980). A 0.3µm mesh was used to capture the flot (light fraction) and 1mm mesh for the residue (heavy fraction). Samples <26>, <32>, <33>, <34>, <35> and <36> were wet-sieved through a 1mm and 0.3µm sieves to avoid breaking up any human bone as these samples were taken from possible cremations. The residues were dried, sieved at 2 and 4mm and then sorted 'by eye' to retrieve artefacts and un-floated organic remains which were then bagged and labelled. The abundance of each class of artefacts (e.g. CBM, pottery, slag, bone) was recorded (using a pro forma) and entered into the database, the following numbers were used to record the abundance of organic and inorganic remains: (1- Occasional (1-10), 2- fairly frequent (11-30), 3- frequent (31-100), 4- abundant (>100)). The flot was dried and the abundance of organic remains was determined using the same method stated above.

13.3 RESULTS

13.3.1 The rapid assessment of the flot and residue contents are presented in table 1.

13.4 DISCUSSION

FLOT

13.4.1 All of the samples produced flot which had no significant value for providing the general environmental background to the site. Only occasional uncharred seeds and charcoal fragments were found, the rest of the flot consisted of modern root material.

RESIDUES

13.4.2 Samples taken from the first phase produced charcoal, bone fragments, burnt flint, pottery and daub. A possible loom weight was also retrieved from sample <23> which was given a provisional date to the Medieval period. Phase two produced only a small quantity of burnt flint and pottery. Overall, the small quantity of artefacts found does not give any indication about specific activities carried out on the site.

13.4.3 A number of samples were taken to extract human bone from possible cremations, however, only two samples <35> and <36> yielded bone and teeth. The samples also contained burnt flint and pottery

but no human bone. This is likely to be linked to the pH of the soil which was taken from a sub-sample of <32> which gave values ranging between moderate to strong acidity. This supports why there is a lack of organic material (charcoal, cereals and seeds) and the varied preservation potential of human bone on the site.

13.5 BIBLIOGRAPHY

Kenward, H, K., Hall, A,R., and Jones, A, K, G (1980). A tested set of techniques for the extraction of plant and animal microfossils from waterlogged archaeological deposits. *Science and Archaeology* 22, 3-15.

Table 1: Results of assessment

	Sample no.	Context no.	Context type	% of context sampled	Volume of sample processed (litres)	Flot						Residue								
						Charred			Un- Charred			Charred				Un- Charred				
						Charcoal	Seeds	Chaff/grain	Seeds	Wood	Root	Charcoal	Seeds	Seeds	Human bone	Bone fragments	Burnt flint	Pottery	Daub	Other
Phase 1	20	112	Fill	5-25%	14	1	-	-	1	-	4	1	-	-	-	1	-	-	1	-
	21	114	Fill	5-25%	15	-	-	-	1	-	4	1	-	-	-	-	-	-	-	-
	22	128	Fill	<5%	14	1	-	-	1	-	4	1	-	-	-	1	1	-	4	-
	23	136	Fill	<5%	13.5	1	-	-	-	-	4	1	-	-	-	-	1	1	1	Possible loom weight
	24	146	Fill	<5%	14	-	-	-	1	-	4	1	-	-	-	1	-	1	1	-
	25	148	Fill	<5%	14.5	1	-	-	1	-	4	4	-	-	-	-	1	2	4	-
	26	184	Fill	100%	4	1	-	-	1	-	4	1	-	-	-	1	1	-	-	-
	27	195	Fill	5-25%	14	-	-	-	-	-	4	-	-	-	-	-	-	-	-	-
	28	206	Fill	<5%	15	1	-	-	1	-	3	-	-	-	-	-	-	-	-	-
Phase 2	31	281	Fill	5-25%	17	1	1	-	-	-	4	-	-	-	-	-	1	1	-	-
	32	356	Fill	100%	6	-	-	-	-	-	4	-	-	-	-	-	1	1	-	-
	33	376	Crem?	100%	20	1	-	-	-	-	1	3	-	-	-	-	4	2	-	-
	34	403	Crem?	100%	7	-	-	-	1	-	4	2	-	-	-	-	1	4	-	-
	35	432	Fill	5-25%	17	-	-	-	-	-	4	1	-	-	2	-	-	-	-	-
	36	433	Fill	100%	5	-	-	-	-	-	2	-	-	-	4	-	-	-	-	-
	37	435	Fill	<5%	22	-	-	-	1	-	4	1	-	-	-	-	1	-	-	-
	38	436	Fill	<5%	20	-	-	-	-	-	4	1	-	-	-	-	1	2	-	-
	39	449	Fill	<5%	17	-	-	-	-	-	4	-	-	-	-	-	-	-	-	-
	40	466	Fill	<5%	19	-	-	-	-	-	-	-	-	-	-	-	-	-	-	-

14 APPENDIX 6: HAROLD WOOD PH DETERMINATION

By G.P. Warren

14.1 INTRODUCTION

14.1.1 This report summarises the findings arising out of the environmental archaeological analysis undertaken of a sample taken during archaeological excavations at "Harold Wood" (HWP-07). The aim of the investigation was to determine the pH value of a soil sample.

14.2 METHODS

14.2.1 The pH value of the soil sample was determined in water (Ministry of Agriculture, Fisheries and Food) and adding calcium chloride (Avery and Bascombe, 1974) according the following procedure:

14.2.2 10g of air dried 2 mm sieved soil are weigh in to a 50 ml centrifuge tube. 25 ml ultra pure are added using an automatic dispenser. Then the sample is placed on the shaker for 15 minutes. The pH meter is calibrated with either pH 4.00 and 7.00 buffers (if the soil suspension might be acidic) or pH 7.00 and 9.22 buffers (if the soil is alkaline). pH electrode are placed in the soil suspension, the pH is recorded after 30 seconds.

14.2.3 2ml of 0.135M CaCl₂ solution are added to the sample. The solution is then mixed and the pH in CaCl₂ is measured soon after.

14.2.4 The electrode should be rinsed with ultra pure water and blot it dry with soft tissues in-between each sample. The calibration of the pH meter should be checked frequently.

14.3 RESULTS

14.3.1 The results of the pH determination are:

- pH in water = 5.87
- pH in 0.01 calcium chloride = 5.52

14.4 CONCLUSIONS

14.4.1 The soil sample HWP-07 has a pH of 5.87 in water and 5.52 in 0.01M calcium chloride, which are typical and normal values for a mineral soil in the UK. As the pH falls between 5.1 -5.5 (calcium chloride) and 5.6 - 6.0 (water) the soil is classed as moderate to strong acidity.

14.5 REFERENCES

Avery, B.W. and Bascombe, C.L. (1974) Soil Survey Laboratory Methods, Soil Survey Technical Monograph 6, Harpenden
Ministry of Agriculture, Fisheries and Food, The Analysis of Agricultural Materials; Agricultural Development and Advisory Service

15 APPENDIX 7: ASSESSMENT OF FIRED CLAY OBJECTS

By Berni Sudds

- 15.1 A total of 18 fragments of fired clay, weighing 1149g, were presented for analysis, representing 7 separate objects (Table 1). The majority appear to have been made from a similar brickearth matrix with the addition of organic matter.
- 15.2 Context [187] contained the fragmented apex of a triangular loomweight. Similar examples in the Greater London region have been recovered from Caesar's Camp, Heathrow (Grimes and Close-Brooks 1993), Ashford Prison, Middlesex (Sudds 2006), Laleham, Surrey (Lyne 2002), Bermondsey Abbey (Rayner 2002), Farningham Hill, Kent (Parfitt 1984), Moor Hall Farm, Rainham (Greenwood 1997) and a number of sites in south-west Essex (Major 1982). The fragments con-join to form one of three original apexes. More complete examples from Danebury, Moor Hall Farm, Laleham and Bermondsey Abbey demonstrate either one hole pierced through the face, or one, two or three holes pierced through the corners from the sides (Poole 1984; Greenwood 1997; Lyne 2002; Rayner 2002). As only one corner was recovered from site it is not possible to determine what form is represented although the orientation of the hole would suggest the weight is an example of the latter group.
- 15.3 Triangular forms are typically Iron Age in date (Foster 1986; Greenwood 1997; Grimes and Close-Brooks 1993; Parfitt 1984; Poole 1984; Rayner 2002) and are commonly interpreted as loomweights. These are likely to have been used on an upright warp-weighted loom but, compared to later Saxon examples, are heavy and occur infrequently, perhaps suggesting they were not used to weight the warp threads directly (Major 1982, 117-9). A modern ethnographic parallel makes use of just three weights attached to a beam for weighting warp (*ibid.*). Alternatively they may have been used as thatch or door weights (Poole 1984, 406).

Context	Description	Number	Weight (g)	Date
112	Fragments from an unidentifiable clay object.	2	51	Pre-historic
128	Fired clay bricks	2	320	Iron Age
187	Triangular loomweight	11	622	Iron Age
255	Fragments from an unidentifiable clay object.	1	43	Pre-historic
268	Fragments from an unidentifiable clay object.	1	11	Pre-historic
334	Possible fired clay brick	1	102	?Iron Age

Table 1: Analysis of fired clay objects

- 15.4 Two incomplete fired clay bricks were recovered from a fill of ditch [129] ([128]). These are small, measuring 4cm by 5cm but with no full length recorded, roughly rectangular in shape with orange surfaces and reduced grey/black cores. The bricks from site have sharp arrises in common with examples from Moor Hall Farm, Rainham (Greenwood 1997, 159) but are more similar in dimension

to examples recovered from Laleham, Surrey (Lyne 2002, 158-9). In the absence of in-situ occurrences, the function of these so called 'Belgic' bricks is uncertain, although at Laleham it was argued they would have been used to line structures for the firing of pottery and other fired clay objects (Lyne 2002, 158-9).

- 15.5 The remaining fragments are too small to identify form with any certainty but demonstrate faces and corners, suggesting they may also derive from triangular loomweights or bricks.

15.6 Bibliography

- Foster, J., 1986. 'Fired clay objects' in I. M. Stead and V. Rigby 'Baldock: The excavation of a Roman and pre-Roman settlement, 1968-72. *Britannia Monograph Series No.7*, 168.
- Greenwood, P., 1997. 'Iron Age London: some thoughts on Current Knowledge and Problems 20 years on'. *London Archaeologist*, Vol.8, No.6, 158-9.
- Grimes, W. F., and Close-Brooks, J., 1993. The excavation of Caesar's Camp, Heathrow, Harmondsworth, Middlesex, 1944. *Proceedings of the Prehistoric Society*, Vol. 59, 303-360.
- Lyne, M., 2002. 'The fired clay objects' in R. Taylor-Wilson 'Excavation of a multi-period site at Laleham, 1997'. *Surrey Archaeological Collections*, 89, 159.
- Major, H. J., 1982. 'Iron Age Triangular Clay Loomweights' in D. Priddy 'Work of the Essex County Council Archaeology Section, 1981'. *Essex Archaeology and History*, 14, 1982.
- Parfitt, K., 1984. 'The small finds' in B. Philp 'Excavations in the Darent Valley, Kent'. *Kent Monograph Series*, 4, 35.
- Poole, C., 1984. 'Clay weights' in B. Cunliffe 'Danebury: an Iron Age hillfort in Hampshire: Vol.2, The excavations 1969-78: the finds'. *CBA Research Report 52*, 401-6.
- Rayner, L., 2002. 'The ceramics' in J. Sidell, J. Cotton, L. Rayner and L. Wheeler 'The prehistory and topography of Southwark and Lambeth'. *Museum of London Archaeology Service Monograph 14*, 42 and 88-94.
- Sudds, B., 2006. 'The Clay Objects' in T. Carew, B. Bishop, F. Meddens & V. Ridgeway 'Unlocking the Landscape: Archaeological Excavations at Ashford Prison, Middlesex'. *PCA Monograph, Monograph 5*, 68-73.

16 APPENDIX 8: LATE IRON AGE AND ROMAN POTTERY ASSESSMENT

By Katie Anderson

16.1 Introduction

16.1.1 An assemblage totalling 798 sherds, weighing 6683g and representing 6.94 EVEs was recovered from the excavation. All of the pottery was examined and recorded in accordance with the guidelines laid out by the Study Group for Roman Pottery (Darling 1994). Sherds were sorted within context by fabric, with unsourced wares of the same type e.g. greywares grouped together. Details of form, decoration, use-wear and date were recorded along with any other information deemed important.

16.2 Assemblage Composition

16.2.1 The pottery dates from the Late Iron Age to the early Roman period, and comprised a variety of handmade, wheel-turned and wheel-made vessels. The fabrics and forms present suggest a peak during the early to mid 1st century AD, with examples of material spanning the Late Iron Age/early Roman transition. Therefore, the Late Iron Age and Romano-British material has not been separated, but instead is considered as a single assemblage.

16.2.2 The assemblage comprised primarily small to medium sized sherds, with a low mean weight of 8.4g. A number of sherds were noted as being abraded and refits were limited, with no examples of cross-context refitting. The condition of the assemblage therefore suggests that many of the sherds were not deposited immediately after breakage, but rather were left on surface for a period of time, or else may have been redeposited from elsewhere.

16.2.3 A variety of fabrics were identified within the assemblage (see Table 1), albeit in varying quantities. Grog-tempered wares were the most commonly occurring fabric group, with four different fabrics having grog as the dominant inclusion (GQ1-GQ3 and GS1), and a further two having grog as a secondary inclusion (QG1 and QGM1). Altogether, grog-tempered wares represented 70% of the total assemblage and were either handmade or wheel-turned/finished.

16.2.4 Sandy wares represented 23.5%, with 5.5% of the assemblage comprising early Roman whitewares, whilst shell-tempered wares represented the remaining 1% of the assemblage. The only sourced wares comprised 41 Verulamium whiteware sherds (from three vessels), which date mid 1st-2nd century AD, and therefore represent some of the latest dating sherds. No imported wares were identified, which is of note, and may be indicative of the relative status/wealth of the site. However, it should also be considered that the lack of imported wares is simply due to the period in which this site peaked; before the influx of Roman imported wares.

16.3 Fabrics

Grog tempered

- GQ1 – Common to frequent small sub-rounded grog in a fine to medium sandy clay matrix
- GQ2 – Common small to very small sub-rounded grog in a fine to medium sandy clay matrix
- GQ3 – Common medium sub-rounded grog in a medium sandy lay matrix.
- GS1 – Occasional to common sub-rounded grog with leached out linears-probably dissolved shell

Quartz tempered

- QGM1 - Fine to medium sandy clay matrix with common sub-rounded grog and common to frequent mica.
- QG1 – A fine to medium sandy clay matrix with occasional to common small sub-rounded grog inclusions
- Q1 – Frequent to abundant medium sandy clay matrix
- Q2 – Medium to coarse sandy clay matrix with occasional larger quartz inclusions and rare to occasional burnt flint
- QC1 - Medium to coarse sandy clay matrix with occasional small calcareous inclusions

Fabric	No.	Wt(g)
Coarse sandy greyware	21	175
Fine sandy micaceous ware	32	153
Fine sandy greyware	66	309
GQ1	138	1105
GQ2	156	1205
GQ3	79	809
GS1	130	1614
Oxidised sandy ware	38	304
Q1	7	21
Q2	1	20
QC1	1	13
QG1	20	98
QGM1	7	67
QV1	4	26
Reduced sandy ware	47	211
Shell tempered ware	7	60
Verulamium whiteware	41	488
Whiteware	3	5
TOTAL	798	6683

Table 1: All pottery by fabric

16.3.1 The range of vessel forms was somewhat limited (see Table 2), although given the condition of the assemblage, this is not unexpected, with 57% of all sherds being non-diagnostic. Jars were the most commonly occurring vessel form, representing 33% of all sherds and 78% of all diagnostic sherds. Within the category there were a variety of different sized vessels, reflecting a range of functions, including the preparation, serving and storage of foodstuffs. Jar rim diameters ranged from 10cm-38cm, with several rim types being typologically Late Iron Age, such as the internally thickened rims, whilst others, namely necked, everted and beaded rims having close affinities with Romanising/Romanised material.

16.3.2 Bowls represented 10% of all diagnostic sherds, although this included just three vessels, including a

half complete wide mouth bowl, with an externally pinched rim, dating to the Late Iron Age. However, a further 18 sherds were recorded as bowl/jar and 16 more as dish/bowl, as the exact vessel form could not be established. Bowl diameters ranged from 22cm to 28cm. Three early Roman beakers were identified, including two vessels with small beaded rims. One further vessel of note was a possible cheese press from context [148], dating to the early Roman period.

Form	No.	Wt(g)
Beaker	15	107
Bowl	32	559
Bowl/jar	18	165
Cheese press	1	1
Dish	16	80
Jar	250	3053
Unknown	466	2718
TOTAL	798	6683

Table 2: All pottery by form

16.3.3 Decoration was fairly uncommon within the assemblage, with just 11% of the assemblage noted as having any. This included vessels with neck cordons, and those with tooled lines. Usewear was even more limited, with little evidence of sooting/burnt residues and/or limescale. This is likely to be due to the condition of the assemblage.

16.4 Contextual Analysis

16.4.1 Pottery was recovered from 46 different contexts (see Table3), with half of these containing ten or fewer sherds. The bulk of the Late Iron Age and early Roman assemblage was recovered from Area 1 (95%)

Context	No.	Wt(g)	Context Spot date
36	19	113	50BC-AD50
38	1	10	50BC-AD50
50	1	36	43-69AD
104	8	64	43-100AD
105	18	158	43-100
112	38	373	AD43-100
114	3	10	0-60AD
118	9	46	50BC-AD50
122	3	12	0-60
128	39	500	0-60AD
130	1	2	50BC-AD50
133	65	614	AD43-100
135	17	391	43-100
136	3	9	0-60
139	10	51	0-60
143	26	230	43-100
144	5	4	0-60
146	47	611	43-100
148	70	748	0-60
153	8	57	0-60
159	3	9	43-69
161	3	21	0-60
182	25	266	50BC-AD50
187	2	9	0-60
191	12	72	50BC-AD50
193	5	9	0-60

cont

Context	No.	Wt(g)	Context Spot date
197	82	390	0-60
201	8	33	50BC-AD50
209	44	488	60-100
229	29	167	0-60
236	23	160	0-60
243	3	31	0-60
245	58	338	50BC-AD50
247	5	9	43-60
250	1	3	50BC-AD50
255	14	89	0-50
257	1	8	43-100
267	41	162	43-69
273	1	13	50BC-AD50
281	1	4	50BC-AD50
322	1	1	43-69
418	1	1	43-69
419	1	13	43-69
435	5	10	50BC-AD50
436	2	6	43-69
437	22	136	43-100
Area 4	11	100	25-69
Tr 3	1	47	50BC-AD50
Area 5	1	18	50BC-AD50
Topsoil	1	31	AD50
TOTAL	798	6683	x

Table3: All pottery by context

16.5 Discussion

16.5.1 The assemblage is indicative of relatively short-lived occupation, from the Late Iron Age to the early Roman period. There were several contexts in which handmade, Late Iron Age pottery occurred alongside Roman/Romanising pottery, suggesting occupation peaked in the decades either side of the Roman conquest.

16.6 Recommendations

16.6.1 All of the pottery has been fully recorded; therefore no further analysis of the material is required. However, the assemblage should be considered within its wider regional context, to assess any local affinities.

17 APPENDIX 9: ANIMAL BONE

By Kevin Rielly

17.1 Introduction

17.1.1 This excavation provided evidence for late prehistoric and early Roman activity shown by a number of ditches and pits, the former probable remnants of enclosures and/or field systems. The dating evidence was generally within the period 50BC to AD100. Most of these features and all of the animal bones were recovered from Area 1. The faunal assemblage amounted to just 26 fragments (see Table 1), all of which were recovered by hand.

Phase:	2	3	4	U	N
Species					
Cattle	1	4	9		14
Cattle-size		2	4		6
Equid			3		3
Sheep/Goat			2		2
Sheep-size				1	1
Grand Total	1	6	18	1	26

Table 1. Species representation in each phase where U is unphased and N is the number of bones identified to each species.

17.2 Methodology

17.2.1 The bone was recorded to species/taxonomic category where possible and to size class in the case of unidentifiable bones such as ribs, fragments of longbone shaft and the majority of vertebra fragments. Recording follows the established techniques whereby details of the element, species, bone portion, state of fusion, wear of the dentition, anatomical measurements and taphonomic including natural and anthropogenic modifications to the bone were registered. The age of the animals is based on tooth eruption and wear (after Schmid 1972, 77) and, in the case of the equids, on crown heights (following Levine 1982).

17.3 Description of faunal assemblage

17.3.1 It can be supposed that this collection was subject to considerable fragmentation pressures as shown perhaps by the better representation of bones belonging to the larger animals and certainly by the predominance of those parts which can best survive such pressures, essentially teeth and certain mandibular pieces, as the diastema (see Tables 1 and 2). In addition, the fragments are all relatively small, where with the exception of the sheep/goat humerus, no part was more than 25% complete. In contrast, the bones are generally well preserved, with 19 fragments showing relatively little surface damage compared to one with moderate and 6 with substantial surface erosion. There would appear to be no discernable pattern concerning the less well preserved fragments with either their location or phase of deposition.

17.3.2 The bones were recovered from the later Iron Age (Phases 2 and 3) as well as the early Roman

deposits (Phase 4) with the majority taken from those dated to the latest phase (see Table 1). As already stated, most of the bones were identified to the larger animals, here represented by cattle, cattle-size and equid. Obviously these few bones may belong to a rather small number of individuals. Cattle is represented by at least three individuals, as shown by the tooth evidence, with the remains of a sub-adult (2nd year) animal taken from the fill of pit [181] (Phase 3) and another sub-adult accompanying a full adult (in excess of 3 years) arising from the fills of ditch [198] (Phase 4). The equid teeth, all from phase 4 deposits, are derived from two adult individuals, a third molar from ditch [183] with a crown height of 69mm suggesting an age of 7 years and a combination of 2nd and 3rd molars from ditch [246] with crown heights of 30 and 33.5mm, thus suggesting an age between 13 and 15 years. These teeth clearly belong to rather small animals, with length and breadth of the third molar from ditch [183] equal to 25.2mm and 21.3, and from ditch [246] equal 25.2mm and 12.9mm respectively. Each may belong to a small pony or possibly a donkey. Notably, the second molar in the latter individual does not exhibit a pli cabaline fold. This is described as a typical horse characteristic, although not exclusive, with rare occurrences and absences in donkeys and horses respectively (Baxter 1998, 7). Thus, while the [246] teeth are likely to represent a donkey, there is the possibility that they actually belong to a small pony. Finally, the third molar of this individual exhibits a marked swelling at the base of the posterior cusp, which could be the result of an infection.

Species	Cattle	Equid	Sheep/Goat
Skeletal part			
Horncore	1		
Maxilla	1		
Maxillary tooth	4	3	
Mandible	3		
Mandibular tooth	3		
Axis			1
Humerus			1
Scapula	1		
Metacarpus	1		
Grand Total	14	3	2

Table 2. Cattle, equid and sheep/goat skeletal representation

17.4 Conclusions and recommendations for further work

- 17.4.1 This small collection is clearly highly fragmented although generally well preserved. It has been taken from deposits within a relatively precise date range, within a few tens of years either side of the Roman conquest, with the greater part dated from the 1st century. The quantities do not allow any comparisons of domestic usage across this formative period of British history or indeed any clear impression of such usage within the larger (Roman) part of the collection. However, for all its limitations, there are a few points of interest. Two out of the three cattle represented are sub-adult, perhaps suggesting a greater use of animals bred for their meat. While of course the quantity of data is extremely small, this information does compare to the early Roman evidence from the much larger

collection taken from Elms Farm, Heybridge, Essex, where approximately 50% of the cattle were culled in their second year (Johnstone and Albarella 2002, 18). The likely presence of donkey is certainly of some interest, with very few confirmed identifications of this species from Roman sites in Britain. In fact there appear to be just three; one from Hadrian's Wall, another from Frocester Court villa in Gloucestershire and lastly from Hunts house, Southwark (Baxter 2002, 93). There was also an equid mandible from Billingsgate Buildings, City of London, identified as a mule (Armitage and Chapman (1979), which indirectly suggests the presence of donkeys.

- 17.4.2 No further work can be recommended, however, the salient points as described in this report should certainly be added to any final published report.

17.5 References

- Armitage, P,L, and Chapman, H, 1979 Roman mules, *London Archaeologist* 3(13), 339-46
- Baxter, I, L, 1998 Species identification of equids from Western European archaeological deposits: methodologies, techniques and problems, in S, Anderson (ed.) *Current and Recent Research in Osteoarchaeology*, Proceedings of the third meeting of the Osteoarchaeological Research Group, Oxford: Oxbow, 3-17.
- Baxter, I, L, 2002 A Donkey (*Equus asinus* L.) Partial Skeleton from a Mid-Late Anglo-Saxon Layer at Dean's Yard, Westminster, London SW1, *Environmental Archaeology*, *The Journal of Human Palaeoecology*,
- Johnstone, C, and Albarella, U 2002 The Late Iron Age and Romano-British Mammal and Bird Bone Assemblage from Elms Farm, Heybridge, Essex (Site Code: Hyef93-95), *Centre for Archaeology Report* 45/2002
- Levine, M. 1982. The use of crown height measurements and eruption-wear sequences to age horse teeth, in B, Wilson, C, Grigson and S, Payne, *Ageing and sexing animal bones from archaeological sites*, *BAR Brit Ser* 109, Oxford, 223-250
- Schmid, E, 1972 *Atlas of animal bones for prehistorians, archaeologists and Quaternary geologists* Elsevier. London.

18 APPENDIX 10: HUMAN BONE ASSESSMENT

By James Young Langthorne

18.1 Introduction

18.1.1 Environmental sampling of two fills, [432] and [433], from a single pit were found to contain crushed and partially cremated human bone. The following report provides a summary of the cremated human bone that is present, not a full osteological analysis of the remains.

18.2 Methodology

18.2.1 All the material recovered from the environmental bulk samples were sieved through a stack of >10, >4, and >2mm mesh sieves. The cremated bone was separated from the remaining organic material, pot and gravel in the >10mm and >4mm fraction and as far as was possible in the >2mm fraction. The bone from the >2mm, >4mm and >10mm fraction sizes were weighed giving the percentage of each fragment size within the total weight of the cremation. The total weight excludes the <2mm fragment size as it is not possible to separate the bone from extraneous material.

18.2.2 A note was made of any identifiable bone fragments, the level of oxidisation illustrated by variations in colour from the normal buff/white colour of a fully oxidised cremation, sexually dimorphic traits and any ageing data, such as epiphyseal fusion and dental development and any pathological lesions.

18.3 Results

18.3.1 The total weights of the cremations and the percentages of each fraction size within these are shown in Table 1 below. The fragments from both contexts were brownish grey in colour and thus not fully oxidised. The bone from these contexts represented very fragmented and partial remains of cremations.

Context	>2mm % weight	>4mm % weight	>9mm % weight	Total Weight (g)
432	6.4	42.3	51.3	78
433	28.6	28.6	42.8	7

Table 1: Weight of cremated bone within the disturbed urns

18.3.2 Identifiable elements were apparent in both contexts:

18.3.3 Context [432] contained no identifiable skeletal elements with the exception of two molars which would have originated from a sub-adult older than 5 years old. The minimum number of individuals (MNI) for this context is one individual.

18.3.4 Context [433] contained two small skull elements, fragments of the petrous part of the temporal, and an almost complete set of maxillary and mandibular dentition which would indicate a juvenile between 5-10 years. The MNI for this context is one individual, probably the same individual encountered in [432].

18.3.5 No pathology was observed on the remains from either context.

18.4 Discussion

- 18.4.1 Studies from modern crematoria suggest that the average weight of a modern adult cremation, with the <2mm fraction removed is 1625.9 g, with a range of 1001.5 – 2422.5g (McKinley, 1993). The weight to an extent depends on the sex and age of the individual although there is an area of overlap (McKinley, 1993). Archaeological cremations tend to have lower total weights than modern cremations due to the more controlled conditions that modern cremated remains are collected in nevertheless the results from the studies of modern cremations can give an idea of the proportion of remains that were finally buried from archaeological cremations.
- 18.4.2 The total weight of the cremated bone from both contexts was considerably lower than that of the average adult and when combined with the evidence of the dentition would indicate that these were the remains of a single juvenile individual of a probable age of between 5-10 years.

18.5 Bibliography

- McKinley, J.I. 1994 Bone fragment size in British cremation burials and its implications for pyre technology and ritual *Journal of Archaeological Science* Vol. 21 P339-342
- McKinley, J.I. 1993 Bone fragment size and weights of bone from modern British cremations and the implications for the interpretation of archaeological cremations. *International Journal of Osteoarchaeology*, Vol.

19 APPENDIX 11: CERAMIC BUILDING MATERIAL ASSESSMENT

by Dr Kevin Hayward

19.1 Introduction and Aims

19.1.1 Two shoe boxes of ceramic building material and stone were retained at excavation from the site at Harrold Wood Hospital, Romford HWP07 TQ 5420 9035.

19.1.2 This small sized assemblage (35 examples 1.8kg) was assessed in order to:

- Identify (under binocular microscope) the fabric and use of the stone samples,
- Identify (under binocular microscope) the fabric and use of the ceramic building material including daub but not fired clay
- Make recommendations for further study.

19.2 Methodology

19.2.1 The application of a 1kg masons hammer and sharp chisel to each example ensured that a small fresh fabric surface was exposed. The fabric was examined at x20 magnification using a long arm stereomicroscope or hand lens (Gowland x10).

19.2.2 Fabric comparison was made with the Pre-Construct Archaeology Building Material Reference Collection. Where this was not possible, a new code was assigned and pre-fixed with HWP e.g. the HWP1 peg- tile

19.3 Catalogue

Roman

19.3.1 Despite the presence of Roman features and pottery at this site (Anderson 2012) no Roman tile and brick was recovered.

Post-Medieval

Brick 2 examples, fabric3032

19.3.2 Two small fragments of purple-red post great fire bricks were recovered from post medieval feature [257]. These were manufactured after 1664.

Peg Tile 20 examples 878g

19.3.3 Sandy fabrics 2271 (1180-1800); 2276 (1480-1900); Iron oxide fabric 2586 (1180-1800); local silty fabric HWP1

19.3.4 Small quantities of abraded post medieval peg tile were found in numerous features [46] [59] [61] [65] [157] [213] [219] [230] [236] [245] [257] [300]. Most were made of the common sandy fabric 2276 prevalent in London after 1480 but also one example each of the earlier 2271 fabric with a reduced core (1180-1800) [157] and iron oxide 2586 (1180-1800) [59] which may indicate earlier post medieval

or even medieval dumped material. Finally, a local silty fabric HWP1 from [46] [61] and [65] may have been manufactured from local silty London clay.

Daub 5 examples 81g

3102

- 19.3.5 As well as the fired clay, loomweight and Belgic brick covered in an accompanying report (Sudds 2012), small quantities of daub from [48] [131] [180] [204] were recovered indicating the presence of wattle and daub structure(s) in the vicinity. The fabric from [204] is different having small lumps of silt included. It is not clear whether these belong to Prehistoric or post medieval occupation.

Stone 9 examples 1.2kg

- 3120 Bunter Pebbles (natural probably not hammerstones) derived originally from Permian and Triassic sandstones West Midlands [182] [437]
- 3115M Mauve/maroon slate (roofing material) Devonian Cornwall e.g. Wadebridge or Delabole slates [157] [213]
- 3155 Worms Heath Puddingstone – Tertiary Harwich Formation (formerly Blackheath Beds), Basal Eocene Warlingham East Surrey and Swanscombe Kent

- 19.3.6 The assemblage can broadly be divided into natural/prehistoric pebbles and puddingstone quernstone and post medieval roofing slate from the West Country. Although the pebbles in the first first group comprised fist-sized pebbles there were no percussion marks and these may simply be natural gravels derived from the underlying glacial beds [335] [370] [401] rather than prehistoric hammer stones. The puddingstone on the other hand is almost certainly a fragment of Beehive quern. These were in wide circulation in southern England during the LIA/ERB. The example from HWP07 with a ferruginous (red) matrix is made from the rarer Worms Heath puddingstone (Shaffrey, 2011 ; Hayward in prep.) rather than the Hertfordshire Pudding stone (with a grey matrix) The stone roofing material intermixed with post medieval peg tile is likely to represent 17th/18th century Delabole slate from the West Country (Stanier. 2000).

19.4 Summary

- 19.4.1 Most of this small group of building material (slate; peg-tile; brick) relates to the post-medieval activity at this site. With the exception of [257], which contained small quantities of post great fire brick, it has (in the absence of any diagnostic mortar) only been possible to provide a broad (1480-1900) date for the peg tile.
- 19.4.2 Despite the presence of Roman features and pottery at this site (Anderson 2012) no Roman tile and brick was recovered.
- 19.4.3 Prehistoric materials include some daub, Worms Heath puddingstone, together with fired clay Belgic Brick and loomweight (Sudds 2012).

19.5 Distribution

Context	Fabric	Form	Size	Date range of material		Latest dated material		Spot date
46	HWP1	Worn post medieval peg tile	1	1400	1900	1400	1900	1400-1900
48	3102	Fragment Daub	1	1500bc	1666	1500bc	1666	1500bc-1666
59	2586	Worn post medieval peg tile	1	1180	1800	1180	1800	1500-1800
61	HWP1	Worn post medieval peg tile	1	1400	1900	1400	1900	1400-1900
65	HWP1	Worn post medieval peg tile	1	1400	1900	1400	1900	1400-1900
157	2276 / 3115M / 2271	Cornish slate and worn post medieval peg tile	2	1100	1950	1100	1950	1480-1900
180	3102	Daub	1	1500bc	1664	1500bc	1664	1500c-1664
182	3120	Bunter pebble no percussion marks	1					Natural
204	3102	Daub silt inclusions	1	1500bc	1664	1500bc	1664	1500bc-1664
213	3115M / 2276	Cornish slate and worn post medieval peg tile	2	1100	1950	1100	1950	1480-1900
219	2276	Worn post medieval peg tile	1	1480	1900	1480	1900	1480-1900
230	2276	Worn post medieval peg tile	1	1480	1900	1480	1900	1480-1900
236	2276	Worn post medieval peg tile	1	1480	1900	1480	1900	1480-1900
245	2276	Worn post medieval peg tile	1	1480	1900	1480	1900	1480-1900
257	3102; 2276; 3032	Worn post medieval peg tile and post great fire brick burnt clay	6	1500bc	1900	1664	1900	1664-1900
300	2276	Worn post medieval peg tile	1	1480	1900	1480	1900	1480-1900
437	3120	Bunter quartzite pebble Natural	1					Natural

19.6 Recommendations

19.6.1 Most of this small assemblage is dominated by common London post-medieval peg tile fabrics and

slate these together with the (natural not hammerstone) Bunter pebbles do not require further work. The emphasis should instead focus on the prehistoric loomweights, Worms Heath Puddingstone (in light of recent discoveries at Stone Castle and Ebbsfleet (Shaffrey, 2011 ; Hayward 2012) and Belgic Bricks (Sudds 2012). Worms Heath Puddingstone has not been identified north of the Thames before and that in itself warrants further consideration.

19.7 Bibliography

- Anderson, K. (2012). Late Iron Age and Roman Pottery HWP07. Unpublished assessment report, Pre-Construct Archaeology Ltd.
- Biddulph, E., Seager-Smith, R. & Schuster, J. (2011). Settling the Ebbsfleet Valley. High Speed Excavations at Springhead and Northfleet, Kent – The Late Iron Age, Roman, Saxon and Medieval Landscape. Volume 2: Late Iron Age and Roman Finds Reports.
- Hayward, K.M.J. (forthcoming). The Quern Stone Castle (KSTC04: KCAS08)
- Shaffrey, R. (2011). The Worked Stone. In Biddulph et. al. (2011): 363-377
- Stanier, P. (2000). Stone Quarrying Landscapes, Tempus publishing.
- Sudds, B. (2012) Loomweights and Fired Clay HWP07. Unpublished assessment report. Pre-Construct Archaeology Ltd.

20 APPENDIX 12: CLAY TOBACCO PIPE ASSESSMENT

Chris Jarrett

- 20.1 Two fragments of undecorated clay tobacco pipe stem were recovered from the excavation and were exclusively found in context [157]. The stems are in a good condition, although they have been subject to a small degree of iron staining resultant from depositional conditions. The stems appear to have been discarded soon after breakage. They are difficult to date, although their thin diameter and narrow bores suggests a 19th century date. The assemblage has no significance, no potential, except to date the context they were recovered from and there are no recommendations for further work.

21 APPENDIX 13: OASIS FORM – HWP07

OASIS ID: preconst1-136671

Project details

Project name	Archaeological Field Evaluation and Excavation of Land at Harold Wood Hospital, Gubbins Lane, Romford
Short description of the project	The Archaeological work revealed features dating from the late Bronze Age to the late Iron Age and early Romano-British transition, thought to represent the remains of field systems and possible farmstead settlement, reflecting the changes to landscape use throughout this period. Four cremations of late Bronze Age to early Iron Age date, and a single cremation of late Iron Age to early Roman date were identified. This latter consisted of a single individual aged between 5 - 10 years old. Finds recovered from the investigations comprised pottery of late Bronze Age to early Roman date consistent with short-lived low density domestic usage with activity peaking in the decades either side of the Roman conquest. Flint tools and burnt stone from the site also suggest later prehistoric and early Roman technologies and fragmentary remains of animal bone intimate that cattle were being kept for their meat.
Project dates	Start: 06-06-2011 End: 25-05-2012
Previous/future work	Yes / No
Any associated project reference codes	HWP 07 - Sitecode
Type of project	Recording project
Site status	None
Current Land use	Residential 1 - General Residential
Monument type	ENCLOSURE Late Prehistoric
Monument type	PITS Roman
Monument type	DITCH Roman
Significant Finds	LITHICS Iron Age
Significant Finds	POTTERY Late Prehistoric
Significant Finds	POTTERY Roman
Investigation type	"Part Excavation", "Watching Brief"
Prompt	Planning condition

Project location

Country	England
Site location	GREATER LONDON HAVERING ROMFORD Harold Wood Hospital
Postcode	RM3 0BE
Study area	4383.00 Square metres
Site coordinates	TQ 5419 9034 51 0 51 35 25 N 000 13 33 E Point
Lat/Long Datum	WGS 84 Datum
Height OD / Depth	Min: 36.00m Max: 38.00m

Project creators

Name of Organisation	PCA
Project brief originator	CgMs Consultants Ltd
Project design originator	Suzanne Gailey
Project director/manager	Chris Mayo
Project supervisor	Mark Beasley
Type of sponsor/funding body	Countryside Properties
Name of sponsor/funding body	Countryside Properties

Project archives

Physical Archive recipient	LAARC
Physical Contents	"Animal Bones","Ceramics","Human Bones","Worked stone/lithics"
Digital Archive recipient	LAARC
Digital Contents	"Animal Bones","Ceramics","Human Bones","Stratigraphic","Survey","Worked stone/lithics"
Digital Media available	"Database","Images raster / digital photography","Images vector","Spreadsheets","Survey","Text"
Paper Archive recipient	LAARC
Paper Contents	"Animal Bones","Ceramics","Human Bones","Stratigraphic","Survey","Worked stone/lithics"
Paper Media available	"Context sheet","Drawing","Matrices","Microfilm","Photograph","Plan","Report","Section","Survey","Unpublished Text"

Project bibliography 1

Publication type	Grey literature (unpublished document/manuscript)
Title	An Assessment of an Archaeological Field Evaluation and Excavation of Land at Harold Wood Hospital, Gubbins Lane, Romford
Author(s)/Editor(s)	Beasley, M.
Other bibliographic details	Report number: R11320 unpublished manuscript
Date	2012
Issuer or publisher	Pre-Construct Archaeology Ltd
Place of issue or publication	London
Description	Assessment report, grey literature

Entered by	Frank Meddens (Frank.meddens@pre-construct.com)
Entered on	2 November 2012

22 APPENDIX 14: PHASE 2B ARCHAEOLOGICAL STRIP, MAP AND SAMPLE INVESTIGATION

By Amelia Fairman

22.1 Introduction

22.1.1 This addendum details the results of an archaeological strip, map and sample undertaken by Pre-Construct Archaeology Ltd on land forming Phase 2B of the redevelopment of the former Harold Wood Hospital, London Borough of Havering. The central National Grid Reference for the site is TQ 5420 9035. The archaeological fieldwork was undertaken between 7th and 18th of September 2015, and the commissioning client was CgMs Consulting on behalf of Countryside Properties Ltd.

22.1.2 As a result of a previous evaluation at the Phase 2b site (Pooley 2012), the Greater London Archaeological Advisory Service (GLAAS), the archaeological advisors to the London Borough of Havering, recommended that further archaeological mitigation was required with regards to late prehistoric remains found in Trench 3. A scheme was therefore devised whereby two areas of the Phase 2b development site were to be machine stripped, the area cleaned and exposed archaeological features mapped and sample excavated. These areas were excavated consecutively and recorded under the site code GUB12. The work therefore also supplements the results of a strip, map and sample exercise in June 2011 (summarised in Hawkins 2011), and was carried out in accordance with a Written Scheme of Investigation approved by GLAAS, English Heritage (Mayo, 2015).

22.1.3 The completed archive comprising written, drawn and photographic records will be deposited with the London Archaeology Archive Resource Centre (LAARC) under the site code GUB12.

22.2 Archaeological Methodology

22.2.1 Two strip, map and sample (SMS) areas were intended for excavation, totalling 328m². If required, three additional contingency areas were proposed totalling 208m². The primary investigation areas were identified as Area A and Area B to the east and west of the site respectively.

22.2.2 The locations of areas A and B were marked out by the client's groundworks contractor, with concrete or hard surfaces broken out. Under continuous archaeological supervision a 360o tracked mechanical excavator fitted with a flat bladed ditching bucket removed all undifferentiated made ground to the first significant archaeological horizon or to the surface of the superficial geology. All overlying deposits were removed in spits of no more than 100mm in depth moving along the length of the trench. No trench supports were anticipated based on the predicted depths of archaeological horizons.

22.2.3 All deposits were recorded on pro-forma context sheets. Trench plans and sections were drawn at a scale of 1:50, and 1:10 respectively. The trenches were located utilising the surveyed trench location points, i.e. the western and eastern limits of excavation for each area. Temporary benchmarks were established at a height of 37.44m AOD adjacent to Area A, and at a height of 37.39m AOD adjacent to Area B. A photographic record was also kept of both areas in digital formats.

22.3 Archaeological Sequence

Phase 1: Natural

- 22.3.1 Firm deposits of mid orange brown silty clay [208], consistent with that described in the other earlier investigation areas, was encountered within areas A and B. Within the latter, natural horizons were confined to the north-western corner only at an elevation of 36.37m OD, dropping to 36.18m OD in the south. These were considered to represent a truncated natural horizon. Within Area B, natural clay remained relatively level across the trench with an average height of around 36.80m OD. A slightly higher outcrop was identified at the uppermost elevation of 36.95m OD in the central part of the excavation area.
- 22.3.2 In the south-eastern limits of area B, the underlying clay was sealed by a 90mm thick layer of soft, light blue alluvial clay [231], and a possible sandy-silt subsoil [224]/[223]. The latter was identified from 37.03m OD with a maximum thickness of 0.19m.

Phase 2: Prehistoric

- 22.3.3 In the north-western corner of Area B were traces of a roughly north-south aligned cut [210]. The cut had been excavated into natural horizons from an identified elevation of 36.68m OD and extended with concave sides and base to 0.36m in depth to 36.32m OD. The western side of the cut was particularly diffuse and the feature appeared to have suffered significant horizontal truncation. This was traced for a total length of 2.20m by 1.35m width, and either terminated or was scoured away in the far north of the trench. The possible ditch had been backfilled naturally with yellow brown sandy clay (redeposited natural) [209] and is likely to represent a continuation of the prehistoric ditch ([10]) as discovered within evaluation Trench 3.

Phase 3: Late Post-Medieval

- 22.3.4 A total of six rounded and squared postholes were identified within Area B. Four of these ([218], [220], [222], [228]) followed a north-west-west south-east-east alignment across the southern part of the area, and were cut into natural horizons from c.36.90m OD. These rounded postholes extended with steep sides to either tapered or flat bases with the largest example extending to c.0.40m in diameter by 0.23m deep. The backfills ([217], [219], [221], [227]) largely comprised brown sandy silt with charcoal, gravel and concrete. Two additional postholes ([216] and [226]) were identified to the north of the main group. These contained comparable fills and similarly extended to a maximum diameter of 0.40m.
- 22.3.5 A rounded pit [212] and north-west-west south-east-east aligned linear cut [214] were also attributed to this phase of activity. The pit extended to a diameter of 1m and exhibited steep, stepped sides to a deeper tapered base in the north of the feature. This had been backfilled with a 0.29m thickness of grey sandy silt containing pottery, glass, CBM and gravel. The assemblage suggested a late post-medieval date range. The linear feature [214] was recorded to a length of 1.25m by 0.50m width and 0.10m depth and had been backfilled with sandy gravel [213] containing large fragments of slag with occasional pieces of pottery and CBM.
- 22.3.6 These features were all subsequently overlain by made ground deposits of dark black brown silty clay containing rooting, modern cables/services and brick rubble [229] and grey brown sandy silt [230] containing flint and sub-rounded gravels. These were primarily located in the eastern and western

limits of the trench respectively and suggested significant truncation/disturbance within the eastern and central areas of the trench. Limited investigation of the latter was carried out due to potential contamination. Layer [229] was identified from 37.19m OD with the maximum thickness of 0.40m and may represent a continuation of made ground deposit [200] as identified within Area A from 36.84m OD.

- 22.3.7 Area A appeared to have suffered from extensive modern/late post-medieval truncation. A large terracing cut [204] and squared cut [207] were located across the southern and north-eastern limits of the trench. These had been backfilled with sandy-clay, purple clinker and gravelly clay ([203], [202], [201]) and dark grey black sandy silt with CBM rubble ([206]) with lenses of red degraded brick and purple clinker respectively.
- 22.3.8 A small brick and concrete drain [205] had subsequently been constructed over upper fill [206]. This extended to 1.10m by 1.10m by over 0.20m from 36.32m OD and contained a red brick lined drain measuring 0.40m in diameter.
- 22.3.9 Area A was subsequently sealed by modern concrete crush (laid down by the current contractors) whereas Area B was overlain by modern made ground and a tarmac road surface.

22.4 Interpretation and Conclusions

- 22.4.1 No archaeological features or horizons of interest were encountered within Area A. This is likely a result of heavy truncation, potentially associated with the former Hospital complex.
- 22.4.2 The extension of such truncation and post-medieval development may explain the limited archaeological features encountered within Area B. A single potential ditch was recorded, representing a continuation of that already identified during the earlier evaluation. This feature could not be traced to the south of the former trench and lensed out towards the north, which might suggest that it had been removed or scoured away during post-medieval landscaping or development.
- 22.4.3 The SMS investigations identified the continuation of a single prehistoric ditch, previously identified within an evaluation trench. The remainder of the trench highlighted extensive post-medieval disturbance as a result of the hospital complex. Deeper intrusions, and a significantly lower natural horizon identified within Area A infers that any archaeological features or horizons within this vicinity have been removed.

22.5 Acknowledgements

- 22.5.1 Pre-Construct Archaeology Ltd. wishes to thank the client Countryside Properties for funding and facilitating this phase of work, and the consultant Suzanne Gailey of CgMs for arranging it. We also thank Laura O’Gorman the archaeology advisor to the LB Havering, GLAAS, for their advice and input.
- 22.5.2 The author wishes to thank Gabija Michailovskyte for her work on site, Jennifer Simonson for the illustrations, Chris Jarrett and Berni Sudds for the finds assessment and Chris Mayo for his project management and editing.

22.6 Bibliography

Mayo, C. 2015, ‘Written Scheme of Investigation for Archaeological Strip, Map and Sample’,

unpublished PCA report

Hawkins, N. 2011, 'Land at Harold Wood Hospital, Romford, RM3 0BE: A Phased Interim Summary of an Archaeological Strip, Map and Sample', unpublished PCA report.

Pooley, A. 2012, 'An Archaeological Evaluation of Land at Harold Wood Hospital, Romford, London Borough of Havering', unpublished PCA report

Seddon, G. 2008 'An Archaeological Evaluation of Land at Harold Wood Hospital, Romford, London Borough of Havering', unpublished PCA report.

22.7 Context Index

Site Code	Context No	Trench	Type	Interpretation	Description	N-S	E-W	Depth	High	Low	Phase	Prov Date
GUB-12	200	Area A	Layer	Made Ground	Dark brown black sandy silt with clinker	0.00	0.00	0.50	36.84	36.43	3	Post-med
GUB-12	201	Area A	Fill	Fill of truncation [204]	Yellow grey sandy clay and gravel with rooting	4.00	8.75	0.10	36.34	0.00	3	Post-med
GUB-12	202	Area A	Fill	Fill of truncation [204]	Purple/black sandy silt with coal/clinker	2.20	7.20	0.10	36.20	0.00	3	Post-med
GUB-12	203	Area A	Fill	Fill of truncation [204]	Yellow/blue-grey sandy clay with flint, ang gravels	2.50	8.75	0.10	36.15	0.00	3	Post-med
GUB-12	204	Area A	Cut	Post-med truncation	Irregular cut with concave sides, base unseen	7.00	8.75	0.30	36.34	0.00	3	Post-med
GUB-12	205	Area A	Masonry	Concrete block	Concrete and red brick block with internal drain	1.10	1.10	0.40	36.32	0.00	3	Post-med
GUB-12	206	Area A	Fill	Fill of truncation [207]	Dark grey brown sandy-clay-silt with CBM rubble	3.45	4.50	1.10	36.38	0.00	3	Post-med
GUB-12	207	Area A	Cut	Post-med truncation	Sub-rectangular cut with vertical sides, base unseen	3.45	4.50	1.10	36.38	35.31	3	Post-med
GUB-12	208	Area A; Area B	Layer	Natural clay	Firm mid brown yellow silty clay with iron staining	0.00	0.00	0.00	36.95	36.18	1	Natural
GUB-12	209	Area B	Fill	Fill of ditch [210]	Mid yellow brown sandy clay	2.20	1.35	0.36	36.68	0.00	2	Prehistoric
GUB-12	210	Area B	Cut	Ditch	Irregular cut with concave sides and base	2.20	1.35	0.36	36.68	36.32	2	Prehistoric
GUB-12	211	Area B	Fill	Fill of pit [212]	Mid brown grey sandy silt with CBM, pot, glass and gravel	0.95	1.00	0.29	36.74	0.00	3	Post-med
GUB-12	212	Area B	Cut	Pit	Sub-circular cut with steep/stepped sides to tapered base	0.95	1.00	0.29	36.74	36.45	3	Post-med
GUB-12	213	Area B	Fill	Fill of linear [214]	Brown grey sandy gravel with slag, CBM, pot	0.50	1.25	0.10	36.82	0.00	3	Post-med
GUB-12	214	Area B	Cut	Post-med truncation	Linear E-W aligned cut with steep sides to concave base	0.50	1.25	0.10	36.82	36.72	3	Post-med
GUB-12	215	Area B	Fill	Fill of posthole [216]	Brown black gravel with charcoal and concrete	0.30	0.35	0.21	36.87	0.00	3	Post-med
GUB-12	216	Area B	Cut	Posthole	Circular cut with concave sides and base	0.30	0.35	0.21	36.87	36.66	3	Post-med
GUB-12	217	Area B	Fill	Fill of posthole [218]	Black grey gravel with concrete	0.35	0.35	0.09	36.84	0.00	3	Post-med
GUB-12	218	Area B	Cut	Posthole	Circular cut with concave sides and base unseen	0.35	0.35	0.09	36.84	36.75	3	Post-med
GUB-12	219	Area B	Fill	Fill of posthole [220]	Grey brown sandy silt with gravel, charcoal and concrete	0.40	0.35	0.17	36.90	0.00	3	Post-med
GUB-12	220	Area B	Cut	Posthole	Circular with steep/near vertical sides to flat base	0.40	0.35	0.17	36.90	36.73	3	Post-med
GUB-12	221	Area B	Fill	Fill of posthole [222]	Grey brown gravel with charcoal	0.40	0.35	0.23	36.94	0.00	3	Post-med
GUB-12	222	Area B	Cut	Posthole	Circular cut with vertical sides to flat base	0.40	0.35	0.23	36.94	36.71	3	Post-med
GUB-12	223	Area B	Layer	Subsoil	Mid grey brown with red iron staining, silty clay with occa gravels	2.60	2.20	0.01	36.95	0.00	1	Natural
GUB-12	224	Area B	Layer	Subsoil	Light grey brown sandy silt with ang gravels, rooting, occa CBM	6.35	4.00	0.19	37.03	0.00	1	Natural
GUB-12	225	Area B	Fill	Fill of posthole [226]	Grey brown silty clay with CBM and charcoal	0.40	0.35	0.12	36.82	0.00	3	Post-med
GUB-12	226	Area B	Cut	Posthole	Circular cut with concave sides and base	0.40	0.35	0.12	36.82	36.70	3	Post-med
GUB-12	227	Area B	Fill	Fill of posthole [228]	Dark grey brown gravel with charcoal flecks	0.28	0.24	0.11	36.81	0.00	3	Post-med
GUB-12	228	Area B	Cut	Posthole	Circular cut with vertical sides and concave base	0.28	0.24	0.11	36.81	36.70	3	Post-med
GUB-12	229	Area B	Layer	Made Ground	Dark black brown silty clay with rooting, modern services, CBM and charcoal	0.00	0.00	0.40	37.19	0.00	3	Post-med
GUB-12	230	Area B	Layer	Made Ground	Dark grey brown sandy silt with flints, gravel and rooting	0.00	0.00	0.14	37.04	0.00	3	Post-med
GUB-12	231	Area B	Layer	Alluvium	Soft, light blue clay silt	0.00	0.00	0.09	36.84	0.00	1	Natural

22.8 Site Matrix

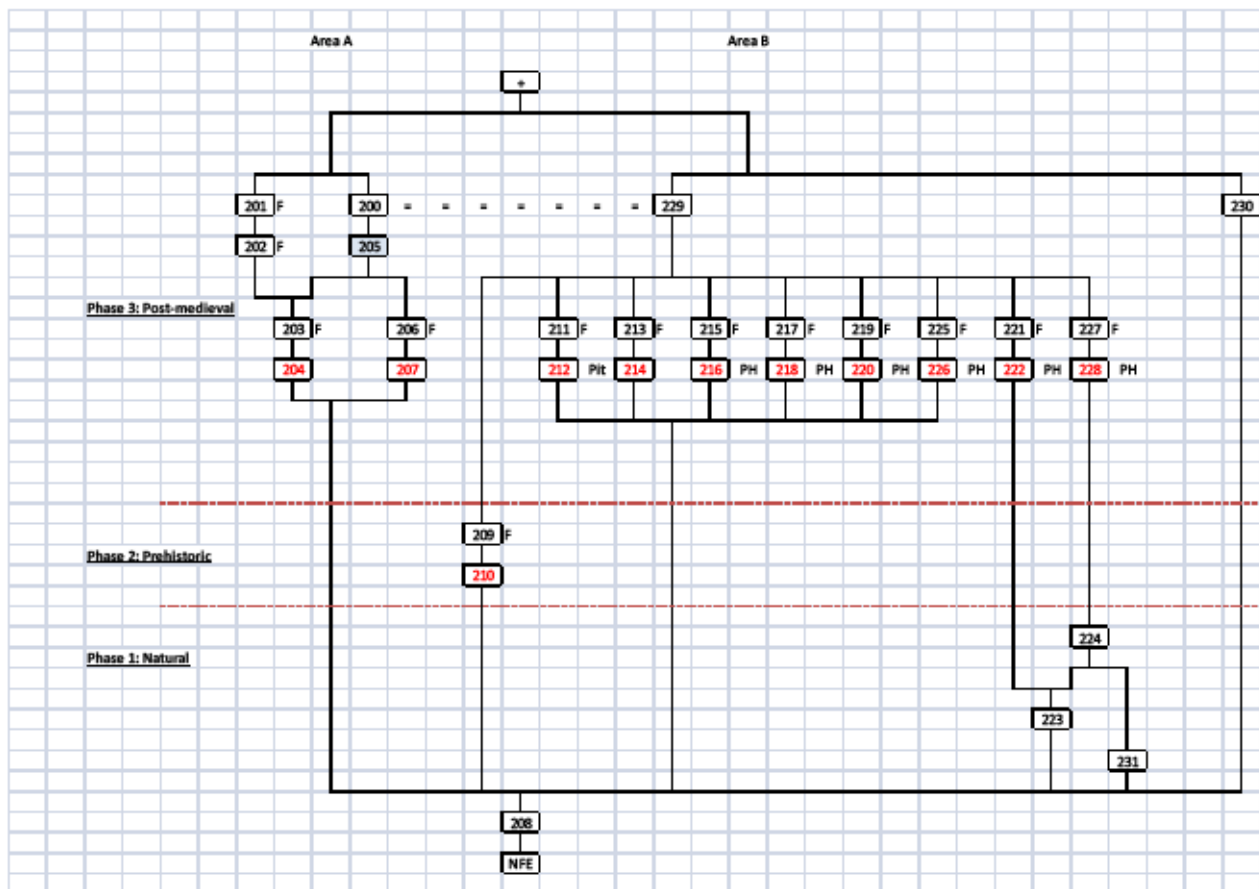

22.9 POST-ROMAN POTTERY ASSESSMENT

By Chris Jarrett, Pre-Construct Archaeology Limited

Introduction

22.9.1 This assessment considers the post-Roman pottery recovered from context [200] onwards. A small sized assemblage of pottery was recovered from the site (one box). The pottery dates only from the post-medieval period. None of the sherds show evidence for abrasion and were probably deposited fairly rapidly after breakage. The fragmentation state of the pottery consists of sherd material, except that two intact vessels are noted. The pottery was quantified by sherd count and estimated number of vessels (ENV), besides weight. Pottery was recovered from two contexts and individual deposits produced only small (fewer than 30 sherds) sized groups of pottery.

22.9.2 All of the pottery (six sherds, 6 ENV and weighing 905g, of which four sherds, 4 ENV and 885g are unstratified) was examined macroscopically and microscopically using a binocular microscope (x20), and recorded in a database format, by fabric, form and decoration. The classification of the pottery types is according to Museum of London Archaeology (2014). The pottery is discussed as a spot dating index.

Spot dating index

Unstratified

- London-area post-medieval redware (PMR), 1580-1900, two sherds, 2 ENV, 67g. Form: 19th-20th century flower pot base and wall sherds.
- English stoneware with Bristol glaze (ENGS BRST), 1830-1900, sherds, 2 ENV, 818g. Form: two intact shouldered bottles, with a narrow flat rim, cylindrical neck and rounded shoulder. External brown glaze.
- Context [213], spot date: 1580-1900
- Late Essex-type post-medieval fine redware with green glaze (LPMFRG), 1580-1900, 1 sherd, 1 ENV, 11g. Form: uncertain, internal green-glaze.
- Context [225], spot date: 1580-1900
- London-area post-medieval redware (PMR), 1580-1900, one sherd, 1 ENV, 9g. Form: 19th-20th century flower pot wall sherd.

Significance and potential of the collection and recommendations for further work

22.9.3 The pottery has little significance at a local level. The pottery is in keeping with the ceramic profile for Metropolitan Essex. The pottery reflects some activity associated with the site, of which the most obvious is the fragments of flower pots that demonstrate horticultural practices occurring there in the recent past. The pottery has only the potential to date the features in which it was found and to provide a sequence for them. None of the pottery merits illustration. There are no recommendations for further work on the assemblage.

References

Museum of London Archaeology 2014, 'Medieval and post-medieval pottery codes'.
<http://www.mola.org.uk/resources/medieval-and-post-medieval-pottery-codes>. Accessed November 2015.

22.10 GLASS ASSESSMENT

By Chris Jarrett, Pre-Construct Archaeology Limited

Introduction

22.10.1 The glass recovered from the archaeological investigation considers only material from context [200] onwards and this consists of seven fragments, representing 4 estimated number of vessels (ENV) and weighing 512g. The glass dates only to the late 19th- early 20th century. The condition of the material is good, but fragmentary and was probably deposited soon after being discarded. The glass was recovered from a single context and it is discussed as a spot dating index.

Spot dating index

Context [211], spot date: late 19th - early 20th century

- Bottle, oval section, made in blue high-lime low-alkali (HLLA) glass, four fragments, 1 ENV, 36g. Base, oval section, body sherd, narrow vertical fluting, two part mould made. Poison/toxic substance container. Late 19th-early 20th century
- Bottle, cylindrical section, made in pale green HLLA glass, one fragment, 1 ENV, 241g. Complete from the neck to the base, rounded shouldered, recessed base, two-piece mould made, moderate ellipse shaped bubbles. Late 19th-early 20th century
- Bottle, cylindrical section, made in pale green tinted HLLA glass, one fragment, 1 ENV, 126g. Base fragment with a short rounded kick and embossed on the underside '2A'. Moulded. ? Wine/spirit bottle. Late 19th-early 20th century
- Bottle, flat oval section, made in pale olive green tinted HLLA glass, one fragment, 1 ENV, 109g. Base, recessed. Late 19th-early 20th century

Significance, potential and recommendations for further work

22.10.2 The glass has no significance at a local level as it consists of mostly fragmentary material derived from typical forms recorded archaeologically in Greater London late 19th-early 20th century dated assemblages. The glass reveals very little about the activities on the site. The only potential of the glass is to broadly date the context it was found in. There are no recommendations for further work on the glass assemblage.

22.11 FLINT ASSESSMENT

By Chris Jarrett, Pre-Construct Archaeology Limited

22.11.1 A single fragment of flint was recovered from context [203] and it weighs 5g. Although the fragment superficially looks like a prehistoric struck flake, it has in fact a freshly 'knapped'/accidental surface and therefore is probably of a modern date. The item has no significance or potential and there are no recommendations for further work on the material.

22.12 THE CERAMIC BUILDING MATERIAL

By Berni Sudds, Pre-Construct Archaeology Limited

Quantity: 9 fragments, weighing 972g

22.12.1 The small assemblage of ceramic building material recovered from site dates to the post-medieval period and is catalogued and dated below in Table 1. The material was examined under magnification (x20) and is described and quantified by number and weight. A date range for each fragment is given in addition to a considered date of deposition. The assemblage has been recorded using the London system of classification. A fabric number is allocated to each object, specifying its composition, form, method of manufacture and approximate date range. Examples of the fabrics can be found in the archives of PCA and/or the Museum of London.

Context	Fabric	Form	No. frag	Wg	Comments	Date range	Context
---------	--------	------	----------	----	----------	------------	---------

							considered date
U/S	2276	Peg tile	1	21	Fine moulding sand. Grey core.	1480 – 1900	1600 – 1900
	2276nr3090	Peg tile	1	24	Abraded.	1480 – 1900	1480 – 1900
203	2276	Peg tile	1	11	Abraded.	1480 – 1900	1480 – 1900
211	3261	Unfrogged fireclay brick	1	363	Dense, well-moulded. Burnt to corner.	1750 – 1950	1800 – 1950
213	2276	Peg tile	1	33	Round peg hole. Fine moulding sand.	1480 – 1900	1600 – 1900
224	2276	Peg tile	1	32	High fired. Fine moulding sand.	1480 – 1900	1600 – 1900
	3090v	Peg tile	1	33	Abraded.	1480 – 1900?	
225	2276	Peg tile	1	5	Fine moulding sand.	1480 – 1900	1600 – 1900
229	3038	Unfrogged brick	1	450	Machine made modern brick (extruded?). 112mm x 68mm.	1850 – 1950	1850 – 1950

22.12.2 The roof tile is comprised entirely of the peg type, occurring predominantly in a fine fabric (2276), common to the greater London region, but also containing abundant mica, more typical of the local metropolitan Essex region variant (2276). A smaller number of fine sandy types were also identified, containing a greater quantity of iron-oxide (nr3090).

22.12.3 The two brick fragments are both relatively recent in date. The firebrick from [211] has been partially burnt and probably dates to the 19th or 20th century, probably utilised in a structure exposed to extreme heat. Similarly, the machine made brick from [229] must post-date c.1850.

22.12.4 The assemblage is small, fragmentary and can be well-paralleled in the locality and broader region. As such no further analysis or discussion is recommended.



© Crown copyright 2015. All rights reserved. License number PMP36110309
 © Pre-Construct Archaeology Ltd 2015
 06/11/15 JS: updated 23/11/15 HB

Figure 1
 Trench Location
 1:800 at A4

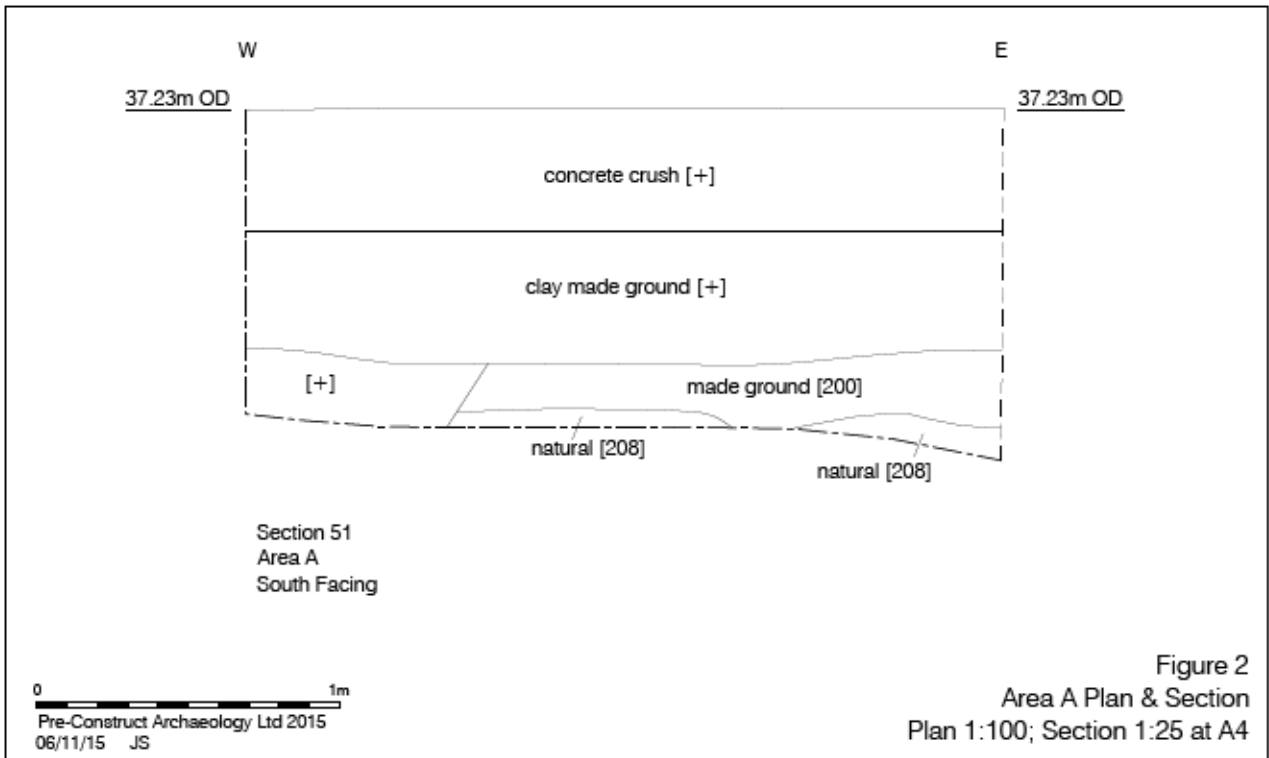

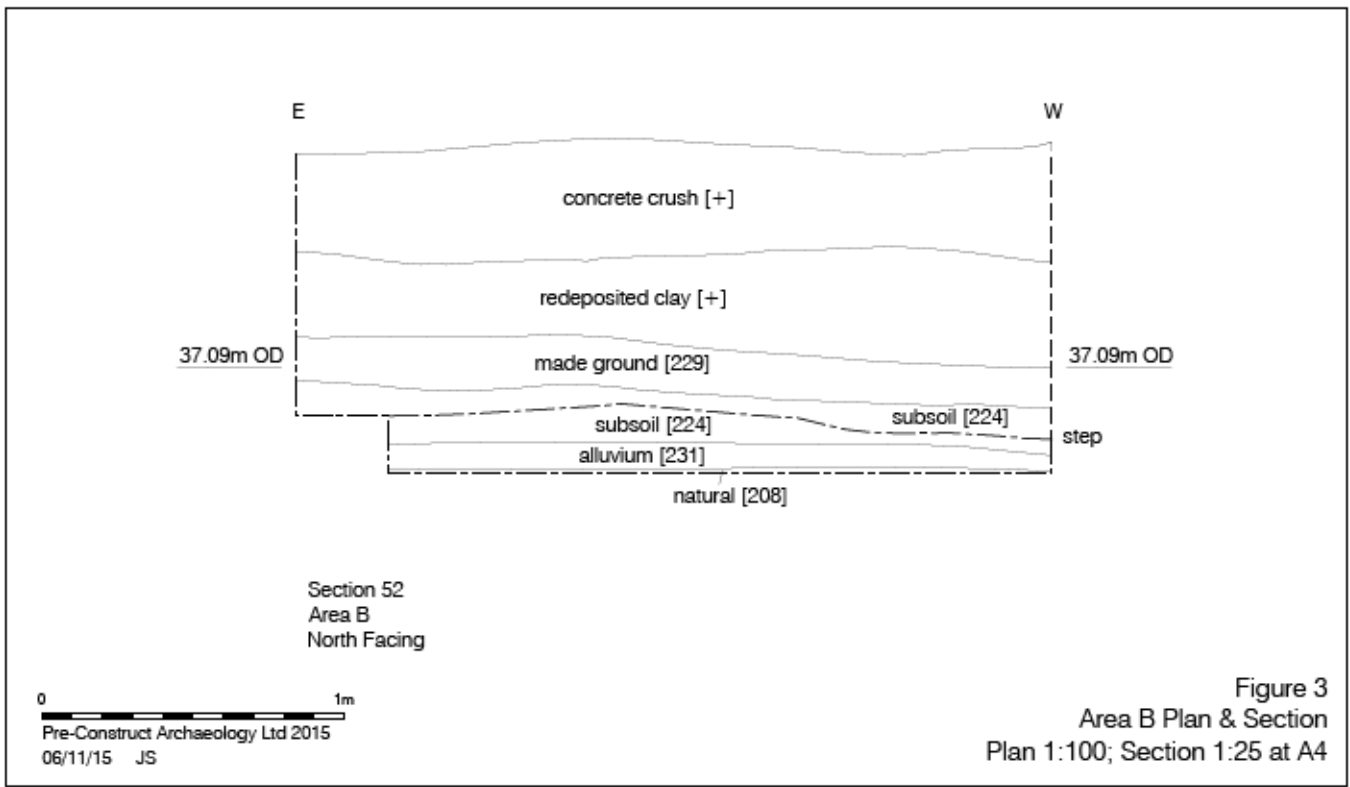
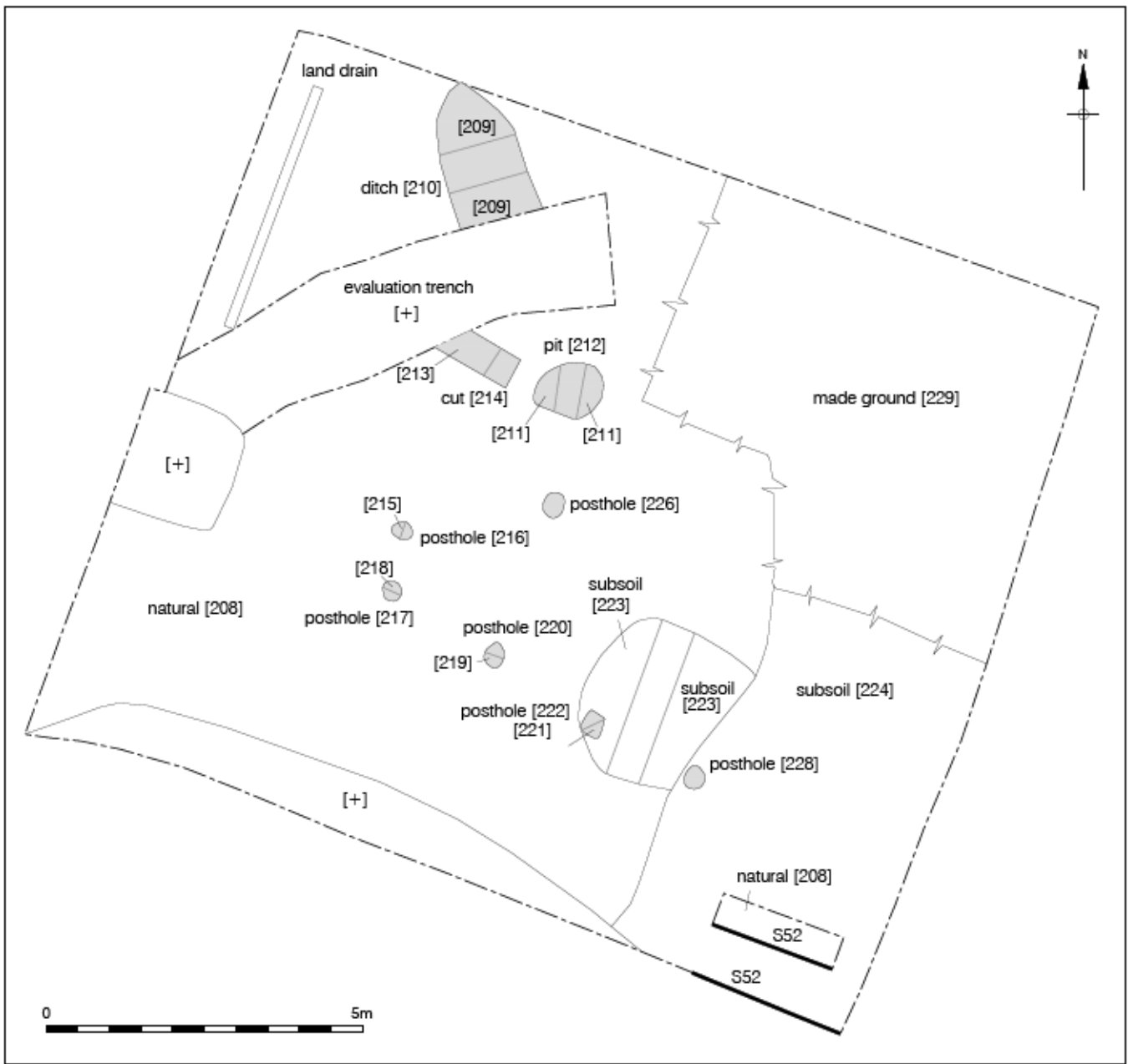

Figure 3
Area B Plan & Section
Plan 1:100; Section 1:25 at A4

23 APPENDIX 15: OASIS FORM – GUB12

OASIS ID: preconst1-224595

Project details	
Project name	An Archaeological Strip, Map and Sample on land at Harold Wood Hospital, Romford, London Borough of Havering
Short description of the project	An archaeological strip, map and and sample was carried out on two areas of the former Harold Wood Hospital site. These were intended to supplement previous investigations and target known features. One of the two areas had been heavily impacted by post-medieval development, presumably associated with the former Hospital complex. The second area was intended to target a known Bronze Age ditch. Although this feature was identified, the remainder of the trench had been impacted by post-medieval redevelopment and no further features of this date were recorded.
Project dates	Start: 07-09-2015 End: 22-09-2015
Previous/future work	Yes / Not known
Any associated project reference codes	GUB12 - Sitecode
Type of project	Recording project
Site status	Area of Archaeological Importance (AAI)
Current Land use	Vacant Land 1 - Vacant land previously developed
Monument type	DITCH Bronze Age
Monument type	POSTHOLE Modern
Monument type	PIT Modern
Significant Finds	POTTERY Post Medieval
Significant Finds	GLASS Post Medieval
Significant Finds	CBM Post Medieval
Investigation type	"Open-area excavation"
Prompt	Planning condition
Project location	
Country	England
Site location	GREATER LONDON HAVERING ROMFORD Harold Wood Hospital, Romford, RM3 0BH: Phase 2B
Postcode	RM3 0BH
Study area	328 Square metres
Site coordinates	TQ 1877 7796 51.487605418287 -0.289172934819 51 29 15 N 000 17 21 W Point
Lat/Long Datum	Unknown
Height OD / Depth	Min: 36.18m Max: 36.95m
Project creators	
Name of Organisation	Pre-Construct Archaeology Limited
Project brief originator	CgMs Consulting
Project design originator	Chris Mayo
Project director/manager	Chris Mayo
Project supervisor	Amelia Fairman
Type of sponsor/funding body	Developer
Name of sponsor/funding body	Countryside Properties
Project archives	
Physical Archive	LAARC

recipient	
Physical Archive ID	GUB12
Physical Contents	"Ceramics", "Glass"
Digital Archive recipient	LAARC
Digital Archive ID	GUB12
Digital Contents	"Stratigraphic"
Digital Media available	"Images raster / digital photography", "Images vector", "Spreadsheets", "Text"
Paper Archive recipient	LAARC
Paper Archive ID	GUB12
Paper Contents	"Stratigraphic"
Paper Media available	"Context sheet", "Map", "Matrices", "Plan", "Section"

Project bibliography 1

Publication type	Grey literature (unpublished document/manuscript)
Title	Harold Wood Hospital (Phase 2b), Romford: An Archaeological Strip, Map and Sample
Author(s)/Editor(s)	Fairman, A.
Other bibliographic details	R11320
Date	2015
Issuer or publisher	Pre-Construct Archaeology Ltd
Place of issue or publication	London
Description	A4 grey literature document provided as Appendix to previous PCA report R11320

Entered by	Chris Mayo (cmayo@pre-construct.com)
Entered on	6 November 2015

PCA

PCA SOUTH

UNIT 54
BROCKLEY CROSS BUSINESS CENTRE
96 ENDWELL ROAD
BROCKLEY
LONDON SE4 2PD
TEL: 020 7732 3925 / 020 7639 9091
FAX: 020 7639 9588
EMAIL: info@pre-construct.com

PCA NORTH

UNIT 19A
TURSDALE BUSINESS PARK
DURHAM DH6 5PG
TEL: 0191 377 1111
FAX: 0191 377 0101
EMAIL: info.north@pre-construct.com

PCA CENTRAL

THE GRANARY, RECTORY FARM
BREWERY ROAD, PAMPISFORD
CAMBRIDGESHIRE CB22 3EN
TEL: 01223 845 522
FAX: 01223 845 522
EMAIL: info.central@pre-construct.com

PCA WEST

BLOCK 4
CHILCOMB HOUSE
CHILCOMB LANE
WINCHESTER
HAMPSHIRE SO23 8RB
TEL: 01962 849 549
EMAIL: info.west@pre-construct.com

PCA MIDLANDS

17-19 KETTERING RD
LITTLE BOWDEN
MARKET HARBOROUGH
LEICESTERSHIRE LE16 8AN
TEL: 01858 468 333
EMAIL: info.midlands@pre-construct.com

