

**Stage 1b archaeological evaluation,
Alienated Land Area L/N,
Colchester Garrison,
Colchester, Essex
October 2007**

**report prepared by
Howard Brooks and Ben Holloway**

**on behalf of
Taylor Wimpey**

CAT project code: 06/10d
Colchester and Ipswich Museums accession code: COLEM 2006.127
NGR: TL 99512 24510 (c)



Colchester Archaeological Trust
12 Lexden Road,
Colchester,
Essex CO3 3NF

tel.: (01206) 541051
(01206) 500124
email: archaeologists@catuk.org

CAT Report 456
March 2008

Contents

1	Summary	1
2	Introduction	1
3	Archaeological, historical and natural background	2
4	Aims and strategy	4
5	Results of the evaluation	4
6	Finds	
6.1	The small finds and bulk metalwork <i>by N Crummy</i>	24
6.2	The metal-working debris <i>by N Crummy</i>	25
6.3	The clay tobacco pipes <i>by N Crummy</i>	25
6.4	The prehistoric, Late Iron Age and Roman pottery <i>by S Benfield</i>	25
6.5	Catalogue of the post-Roman pottery <i>by H Brooks</i>	30
6.6	Catalogue of Roman and later ceramic finds and building materials <i>by H Brooks</i>	31
6.7	Catalogue of other finds <i>by H Brooks</i>	34
7	Discussion	35
8	Acknowledgements	37
9	References	37
10	Abbreviations and glossary	39
11	Archive deposition	40
12	Context list	40
	Figures	after p 44
	EHER summary sheet	

List of figures

- Fig 1 Site location.
- Fig 2 Plan of 2002 trenches (N, GJ and YP prefix) and 2007 trenches (T1-T62).
- Fig 3 T3-T12: plans.
- Fig 4 T13-T21: plans.
- Fig 5 T22-T30: plans.
- Fig 6 T31-T35 and T37-T38: plans.
- Fig 7 T39-T49: plans.
- Fig 8 T50-T55 and T57-T58: plans.
- Fig 9 T59-T62: plans.
- Fig 10 T12-T13: Roman ditch sections.
- Fig 11 T14: Roman ditch section.
- Fig 12 T17, T19, T21: Roman ditch sections.
- Fig 13 T28, T49, T60, T61: Roman ditch sections; T13, T17: Roman post-hole sections and profiles.
- Fig 14 T35, T51: Roman post-hole profiles; T21, T50, T53: Roman pit sections; T31, T50: natural feature sections.
- Fig 15 T12, T13, T20, T49, T52, T59: post-medieval ditch sections.
- Fig 16 T12, T24: post-medieval pit sections.
- Fig 17 Royal Engineers' 1949 plan of Colchester Garrison (area of Goojerat Barracks).

1 Summary

Colchester Garrison Alienated Land Area L/N coincides with the Goojerat Barracks south of Goojerat Road and east of Cambrai Road.

The principal remains revealed by the 62 evaluation trenches were the widespread remains of barrack buildings. Around and under the buildings there were extensive areas where the ground had been reduced (ie truncated) or built up (ie infilled). This truncation and infilling is undoubtedly due to large-scale landscaping carried out when Goojerat Barracks was constructed in 1900-1902, or when it was rebuilt in 1971-75.

The truncation has severely affected the survival of earlier archaeological horizons and features. Only nine Roman and two post-medieval ditches were identified, plus a number of Roman post-holes.

The post-medieval ditches defined parts of a pre-Garrison landscape, or may have been associated with the Civil War, when Colchester was besieged in 1648.

The alignment of the Roman ditches in Area L/N indicates that there was a co-axial Roman farmed landscape here, aligned south-west to north-east and north-west to south-east. Further, the configuration of the Roman ditches and the presence of over 11kg of Roman building materials may indicate the presence of a rectangular Roman enclosure, possibly containing a robbed-out Roman structure, in the south-east corner of Area L/N.

A simple Roman 'villa-type' agricultural establishment has been identified at the Kirkee McMunn Barracks (approximately 1km to the south of this site), and a smaller-scale Roman settlement has recently been identified in GAL Area E (approximately 500m to the north-east). It remains to be seen how the Area L/N building fitted into this Roman farmed and inhabited landscape.

2 Introduction (Figs 1-3)

- 2.1** This is the archive report on the Stage 1b archaeological trial-trenching evaluation undertaken by the Colchester Archaeological Trust (CAT) on Taylor Wimpey's (formerly Taylor Woodrow's) Garrison Alienated Land (GAL) redevelopment Area L/N, Goojerat Barracks, Colchester Garrison, Colchester, Essex (Fig 1). Previous stages of evaluation in this Area are listed in section 2.5 (below).
- 2.2** Goojerat Barracks is located to the east of Cambrai Road, and south of Goojerat Road. Development proposals within Area L/N will comprise the demolition of the existing 20th-century barracks (built in 1971-75), and the construction of residential units and an upgraded access road network.
- 2.3** This 8.57ha parcel of land, which is centred on NGR TL 99512 24510, is currently under the ownership of MoD/RMPA, but will shortly be passed to Taylor Wimpey for redevelopment.
- 2.4** The archaeological requirements for archaeological evaluation of this parcel of land were originally included in a 2002 strategy document for the overall development (*Colchester Garrison outline archaeological project strategy proposal and quality plan*, RPS 2002) in support of outline planning consent. An overall archaeological strategy was subsequently provided for the Alienated Land (Taylor Wimpey) stage of the project in support of full planning consent by RPS Planning (RPS 2004). The updated strategy provides an outline framework for the mitigation of the archaeological impacts on the Alienated Land. This document was required by and agreed by Colchester Borough Council (CBC). Figures 1-2 show Area L/N in relation to the other parcels of land being developed as a consequence of the redevelopment of Colchester Garrison.
- 2.5** Part of the trial-trenching in Area L/N had previously been undertaken on behalf of RMPA Services in advance of outline planning permission in 2002 (Stage 1a). At this time, CAT, managed by RPS Planning, undertook trenching in available areas to provide a 0.2% sample of Area L and a 0.47% sample of Area N. This comprised eight trenches within available grassed and tarmac areas (CAT Report 206, fig 13). The 2002 trenches N1 and N2 were located within the central car-park/Parade Ground, and were cut through tarmac. The remainder were within grassed areas. The trenching in 2002 revealed no significant archaeological features or deposits.

- 2.6** The archaeological strategy for the overall project requires the level of trenching for full planning permission to be raised to 3%, unless otherwise agreed with CBC/English Heritage. The trench positions in support of full planning are shown on Figure 2. To achieve the 3% figure, further trenching was required. This equates to a further 2.8% (ie 1,484m² or 824m of 1.8m-wide trenches) in Area L (formerly Area GJ), and a further 2.53% (ie 828m² or 460m of 1.8m-wide trenches) in Area N. (in total, 62 trenches, 1.8m wide, and 1,199m long were excavated) The information obtained from the combined Stage 1a and 1b evaluations (reported here) will determine whether further mitigation (excavations, watching briefs or avoidance strategies) will be required ahead of or during the construction phase.
- 2.7** A Written Scheme of Investigation (WSI) for Area L/N was submitted to and approved by CBC (RPS 2007).
- 2.8** In addition to the archaeological strategy (RPS 2004) and the Area L/N WSI (RPS 2007), all fieldwork and reporting was undertaken in accordance with CAT's *Policies and procedures* (CAT 1999), Colchester Borough Council's *Guidelines on standards and practices for archaeological fieldwork in the Borough of Colchester* (CM 2002) and *Guidelines on the preparation and transfer of archaeological archives to Colchester Museums* (CM 2003), the Institute of Field Archaeologists' *Standard and guidance for archaeological field evaluation* (IFA 1999) and *Standard and guidance for the collection, documentation, conservation and research of archaeological materials* (IFA 2001). The guidance contained in the documents *Management of archaeological projects* (MAP 2), and *Research and archaeology: a framework for the Eastern Counties 1. Resource assessment* (EAA 3), *Research and archaeology: a framework for the Eastern Counties 2. Research agenda and strategy* (EAA 8), and *Standards for field archaeology in the East of England* (EAA 14) was also followed.

3 Archaeological, historical and natural background

3.1 Introduction

The archaeological and historical setting of the Garrison redevelopment site has already been comprehensively explored in CAT Report 97 (An archaeological desk-based assessment of the Colchester Garrison PFI site).

Area L/N, like much of the land south and south-west of Colchester's modern and Roman walled town, lies within the area of the pre-Roman *oppidum* of Camulodunum, the Catuvellaunian royal estate. The Garrison site lies within the eastern edge of the *oppidum*, the only above-ground traces of which are the linear banks and ditches of the defensive dyke system that surrounded it. One of these (the Berechurch Dyke) crosses the extreme south-eastern edge of the Garrison, on the east edge of Roman Barracks (GAL Area S2 (south); CAT Report 428).

3.2 Geology

Drift geology of the area is predominantly sand-and-gravel. This is occasionally in a clay matrix, and is sometimes capped by cover loam. Area L/N lies on a broadly flat site, although there is shallow valley running through it from east to west which has been infilled. The valley is more pronounced to the east of Area L/N, where its course corresponds to the line of Circular Road South. The 2002 evaluation found deposits associated with the silting/colluviation within the valley in the south-east corner of Area N (CAT Report 206). These deposits were undated. Elsewhere the natural sand-and-gravel were encountered at a depth of approximately 0.6m below present ground-level.

3.3 Neolithic to Early Iron Age

No pre-modern archaeological features are known within Area L/N, although prehistoric pottery has been found to the north of Area L/N during the GAL project, ie Neolithic pottery in Area C1, Early Bronze Age pottery in Area C2, and Late Bronze Age pottery, particularly in Area J1 (CAT Report 412 forthcoming).

In addition, a Middle Iron Age settlement enclosure containing a round-house was excavated in 2003 to the south-east to the south of Ypres Road (new garrison Archaeological Area 2; CAT Report 292). Pottery scatters to the south of Area L/N

(just east of the former Kirkee McMunn Barracks) are indicative of early Middle Iron Age manuring (and therefore arable farming), while possible settlement areas of Early Iron Age date were also found during the new garrison and Alienated Land projects to the south-east of Area L/N in areas to the north and south of Roman Barracks, ie Alienated Land Area S2 (south) (CAT Report 428) and new garrison Area 10 (CAT Report 292). The Neolithic and Bronze Age pits identified during the Alienated Land project are indicative of intermittent or seasonal occupation which may extend south, whilst the later prehistoric settlement evidence, fragmentary as it is (particularly prior to the Middle Iron Age) indicates the potential that the land within Area L/N was farmed and/or settled during the Iron Age (CAT Report 361).

3.4 Late Iron Age

Notably few clear traces of the Late Iron Age *oppidum* landscape of Camulodunum have been identified to date during the Alienated Land project. However, it is potentially significant that Late Iron Age pottery is recorded on the Urban Archaeological Database (UAD) just to the west of the south-western corner of the Parade Ground in Area L (UAD event no 1250) and at a location just to the south of Area N (also numbered UAD event no 1250; CAT Report 97). The broad location of these previous findspots is shown on Figure 2. Although the original context of the pottery is unknown, it may derive from settlement at or in the vicinity of Area L/N.

3.5 Roman

Roman cemeteries are known to have occupied land to the south of the Roman circus (well to the north of Area L/N) and flanking a wide track or driveway found within Area J1 and extending south through the western side of the Abbey Field (east of Area L/N). Given the association of burials with the walled town and the approach roads close to it, large numbers of Roman burials were considered unlikely in Area L/N, which is more likely to have been a rural Roman landscape.

Roman settlement in the vicinity of Area L/N comprised a 'villa-type' building within a ditched compound in Area E (to the east of the Abbey Field and 0.5km north-east of Area L/N: CAT Report 412) and a similar building with a hypocaust within the south-east corner of the former Kirkee McMunn Barracks (1.0km to the south of Area L/N (Shimmin 1998). Further occupation is now known to have existed approximately 900m to the north-east within the Flagstaff House compound (evidence for which was found during Alienated Land evaluations of Areas B1a and B1b in 2007; CAT Reports 405 and 438). Area L/N may be a little too close to these settlements to be the site of another farmstead, although such a possibility cannot be discounted.

3.6 Anglo-Saxon

Fragmentary remains and grave goods found in the 19th century indicate that there was an early Anglo-Saxon cemetery just east of Mersea Road (CAR 1, 14). This appears to have extended as far south as Meeanee Barracks, where a later 4th-century cremation burial was found in 1938 (CAR 1, 14). Whilst the location of this cemetery 0.9km to the north-east of Area L/N could indicate a nearby occupation site, there is currently no firm evidence for this.

There are no further indications of Anglo-Saxon settlement in the area. Place name evidence includes Monkwick, some 1.2km south-east of Area L/N. This was a small village in the mid 19th century (see Gilberd's *Map of Colchester*, 1846) with origins in the Anglo-Saxon or Roman period suggested by the 'wick' element (indicating Anglo-Saxon occupation following a former Roman occupation).

3.7 Medieval

The major medieval site in this area is St John's Abbey (in GAL Area B), 0.9km to the north-east of Area L/N. The land now occupied by Area L/N site is likely to have been farmland at that time, although the presence of rural settlement cannot be discounted.

3.8 Goojerat Barracks

Again there is little evidence from the 2002 trial-trenches relating to the early post-medieval period. The area appears to have been entirely rural in character. Goojerat

Barracks was built between 1900 and 1902, demolished in 1970-71, and was completely rebuilt between 1971 and 1975 to become the headquarters of the Airborne Brigade (CAT Report 97, 47). The Study Centre is a notable Victorian or Edwardian building formerly used as the Garrison Theatre, and still possesses its stage (*op cit*; shown as Theatre on Fig 17). Before this it was a canteen.

Copies of the historic maps mentioned below can be found in the desk-based assessment for the Colchester Garrison PFI site (CAT Report 97). Speed's map of Colchester (1610) shows Area L/N to be open, but has little detail. This situation is mirrored by the map of the 1648 siege of Colchester. However, the siege defences are of some interest; although they are drawn schematically and not to scale, they do indicate that east-west aligned defensive positions (?ditches) may have been located in the proximity of Area L/N, or perhaps just a little to the north. The French map of Colchester (1650), Chapman and Andre's map of the County of Essex (1777), Cole and Roper's map of Colchester (c 1800-1815), and Gilbert's map of Colchester (1846) all show the area as open farmland. Layer Road, to the west of Goojerat Barracks, is shown on the 1777 map in the same position as today. The 1st Edition OS (1:2500) of 1874-1876 shows the area of the present barracks divided into two large fields. The OS (1:2500) map of 1921 is the earliest to record the new Goojerat Barracks, shown to the south of Cavalry Barracks and connecting with the former Sobraon Barracks to the east (also built between 1900 and 1902, but last used in 1960 and demolished in 1970-71). The 1949 Royal Engineers' plan of Colchester Garrison shows the area between Goojerat Barracks and Layer Road built up as residential, with the barracks little changed (copy of RE 1949 plan in CAT archives; see Fig 17). Later OS maps show the barrack buildings (built in 1971-75), some of which currently occupy the site.

4 Aims and strategy

The general aim of the evaluation was to recover sufficient evidence to characterise the nature, date, function and importance of archaeological features in the site. The over-arching research themes, as stated in the research design, are:

- a) to inform how the landscape was used and to what level of intensification, prior to the construction of Camulodunum; are there further indications of late Neolithic and Bronze Age settlement?
- b) to elucidate the nature of spatial organisation within the *oppidum*,
- c) to address the question of the effect of the establishment of the Roman town on the agricultural hinterland, and
- d) to elucidate the relative density of Roman burials and the influence of the recently-discovered Roman circus across the northern area of Colchester Garrison.

Specific aims for Area L/N were:

- a) to establish the presence/absence and/or character of prehistoric activity and, in particular, the context of the Late Iron Age pottery noted on the UAD,
- b) to determine whether there was any Roman settlement,
- c) to determine whether there was any Anglo-Saxon or medieval settlement,
- d) to determine the nature of any archaeological features associated with the 1648 siege of Colchester during the Civil War, and
- e) to identify, and, if necessary, excavate, record and legally remove any human burials (under a Ministry of Justice - formerly Home Office - licence).

5 Results of the evaluation (Figs 2-16)

This section gives an archaeological summary of each trench with a tabulation of context and finds dating information.

Table 1 gives the height of ground-level and limit of excavation (on natural sands and gravels) for those trenches which are not illustrated in Figures 10-16.

For logistical and timing reasons, Area L/N was split into five phased areas, as follows:

- Area L/N Phase 1: T3-T35 (T1-T2 not dug)
- Area L/N Phase 2a: T36-T41 (T36 not dug)
- Area L/N Phase 2b: T42-T48
- Area L/N Phase 3: T49-T55
- Area L/N Phase 4: T56-T62 (T56 not dug).

Table 1: height OD of top of trench and limit of excavation.

Trench	Top of trench (ie ground-level)	Bottom of trench if on modern infill or quarry-pit	Bottom of trench if on natural
T3	33.07m		32.19m
T4	32.42m	31.15m	
T5	32.71m	31.68m	
T6	32.74m	31.45m	
T7	32.38m		30.62m
T8	32.30m		31.33m
T9	32.59m	30.74m	
T10	32.58m		31.56m
T11	31.69m		30.45m
T12	31.53m		30.18m
T13	31.72m		31.06m
T14	31.67m		31.00m
T15	32.15m		31.62m
T16	31.26m		30.89m
T17	30.93m		30.36m
T18	32.36m		31.95m
T19	32.40m		31.90m
T20	31.60m		31.10m
T21	31.57m		31.03m
T22	31.57m	30.43m	
T23	31.53m	30.37m	
T24	31.74m	31.19m	
T25	32.26m		31.36m
T26	31.50m	30.07m	
T27	31.60m		31.30m
T28	31.22m		30.61m
T29	32.94m	31.94m	
T30	33.00m		32.25m
T31	32.18m		31.90m
T32	32.45m		32.12m
T33	32.97m		32.65m
T34	33.33m		32.52m
T35	33.46m		33.07m
T37	33.84m	32.45m	
T38	33.80m	32.63m	
T39	33.53m	32.30m	
T40	33.51m	32.29m	
T41	33.32m	32.02m	
T42	33.25m		32.67m
T43	32.94m		32.53m
T44	32.47m		31.57m
T45	32.82m		32.65m
T46	32.15m		31.53m
T47	33.35m	31.76m	
T48	33.24m	32.00m	
T49	33.70m		32.64m
T50	34.11m		33.95m
T51	33.87m		33.51m
T52	33.90m		33.48m
T53	33.54m		32.98m

T54	33.51m		32.95m
T55	33.37m		32.95m
T57	32.94m		32.08m
T58	32.66m	31.40m	
T59	33.05m		32.38m
T60	32.56m		31.74m
T61	33.31m		32.87m
T62	33.14m		32.68m

Trenches 1 and 2

T1 and T2 were located on the northern edge of Area L/N. In consultation with RPS Planning, it was decided not to excavate these trenches because of the presence of known and unplotted service runs (ie from CAT scanning). However, the lost meterage was made up elsewhere on the site.

Trench 3 (Figs 2-3)

T3 was located in a grassed area in the north-eastern part of Area L/N. The excavated sequence was as follows: a thin layer of modern topsoil (L1) sealed modern accumulation (L2), which in turn sealed natural (L5) at a depth of 0.82m, and a large modern pit (F1). The pit was left unexcavated due the possible EOD risk. It contained fragments of modern building rubble which are probably associated with the rebuilding of Goojerat Barracks in 1971-75.

Context	type	dated finds	period
F1	pit	brick rubble (not retained)	modern

Trench 4 (Figs 2-3)

T4 was located within a tarmac car-park in the centre of Area L/N. As was the case with T37-T41 to the west, T4 revealed a large area of modern infill which was probably associated with site preparation for the construction of Goojerat Barracks in 1900-1902.

T4 was excavated through modern hard-top (L7), imported modern material (L9), and redeposited natural (L10). Two unnumbered modern service runs were identified, but no significant archaeological features were observed in the trench.

Limit of excavation was 1.2m below ground-level. Natural ground (L5) was not reached here, but auger probing identified it at 1.8m below ground-level.

Trench 5 (Figs 2-3)

As with T4, T5 was located within the car-park in the centre of Area L/N. As was the case with T37-T41 to the west, T5 revealed a large area of modern infill. This infilling was probably associated with site preparation for the construction of Goojerat Barracks in 1900-1902.

T5 was excavated through modern hard-top (L7), imported modern material (L9) and redeposited natural (L10). The only archaeological feature was a large post-medieval pit (presumed to be of military origin).

Limit of excavation was 1.2m below ground-level. Natural ground (L5) was not reached here, but auger probing located it at 1.8m below ground-level.

Context	type	dated finds	period
F33	military rubbish-pit	peg-tiles, post-medieval pottery and glass, Roman brick and tiles, Roman pottery	modern

Trench 6 (Figs 2-3)

As with T4 and T5, T6 was located in the car-park in the centre of Area L/N. As was the case with T37-T41 to the west, T6 revealed a large area of modern infill. This infilling was probably associated with site preparation for the construction of Goojerat Barracks in 1900-1902.

T6 was excavated through modern hard-top (L7), imported modern material (L9), and redeposited natural (L10). No significant archaeological features were identified in the trench.

Limit of excavation was 1.2m below ground-level. Natural ground (L5) was not reached here, but auger probing identified it at 1.8m below ground-level.

Trench 7 (Figs 2-3)

T7 was located in a grassed area in the north-eastern part of Area L/N.

The excavated sequence was as follows: a thin layer of modern topsoil (L1) sealed modern accumulation (L2). These sealed a quarry-pit F5, which appears to be the northern edge of a larger area of quarrying activity.

Limit of excavation was at 1.2m below ground-level. Natural ground was not exposed at this depth, but an auger probe at the base of pit F5 identified it at 0.5m below trench bottom (ie at 1.7m below ground-level).

Post-medieval brick and peg-tile fragments in quarry-pit F5 indicate that the quarrying activity pre-dated the construction of the Garrison.

Context	type	dated finds	period
F5	quarry-pit	post-medieval brick, peg-tile (not recovered)	post-medieval

Trench 8 (Figs 2-3)

T8 was located in a grassed area on the eastern edge of Area L/N. The excavated sequence was as follows: modern topsoil (L1) sealed modern subsoil accumulation (L4), which sealed archaeological features cut into natural (L5).

As in T3, there was no evidence of modern infill or truncation with natural sand/gravel at a depth of 0.95m. Excavated features consisted of three post-medieval/modern pits (F2, F3, F4), dated by post-medieval pottery fragments, post-medieval brick, and peg-tile. They may be associated with pre-Garrison quarrying activity, or possibly with the construction of Goojerat Barracks in 1900-1902.

Context	type	dated finds	period
F2	pit	Roman tile, post- medieval pottery	post- medieval/modern
F3	pit	brick, peg-tile, post-medieval pottery	post- medieval/modern
F4	pit	brick, peg-tile (not recovered)	post- medieval/modern

Trench 9 (Figs 2-3)

T9 was located on the eastern half of the evaluation site. The excavated sequence was as follows: modern topsoil (L1) sealed modern accumulated soils (L2 and L3), the latter of which sealed L6.

No individual features were identified in T9, but L6 resembled the fill of quarry-pit F5 in T7. Assuming that L6 was a quarry-pit, no edges were apparent in T9.

It is likely that the quarrying activity pre-dated the construction of the Garrison.

Trench 10 (Figs 2-3)

T10 was located in a grassed area in the eastern half of Area L/N. The excavated sequence was as follows: modern topsoil (L1) sealed modern accumulated soils (L2/L3), the latter of which sealed natural (L5) at a depth of 1.0m. The depth of the

natural suggests that this location may have been within a shallow valley (see also T11, T12, T57, T58 and T60).

A single feature was identified at the western end of the trench (F6). Its irregular cut and slightly leached-out fills may indicate that it was a natural pit. However, minor charcoal flecking in the fill may indicate that it was a tree-throw pit produced by deliberate burning to remove a tree stump to clear land for agriculture.

Context	type	dated finds	period
F6	natural pit or tree-throw pit	-	undated

Trench 11 (Figs 2-3)

T11 was located in the eastern half of Area L/N on an area of tarmac road. The excavated sequence was as follows: hard-top (L7) sealing modern material (L9), sealing a post-Roman subsoil (L12), which contained Roman tile, and charcoal flecking. L12 sealed a fine colluvial hill-wash (L13) containing only Roman finds, ie pottery and tile. Natural gravel was recorded at a depth of 1.25m.

This sequence of deposits shows the gradual silting, through the Roman and immediate post-Roman periods, of an axial valley of the main east-west valley located at the south edge of the Abbey Field (see Fig 2).

Trench 12 (Figs 2-3, 10, 15, 16)

As was the case with T11, T12 was located on a road area in the eastern half of Area L/N. The excavated sequence was as follows: modern hard-top (L7) sealed modern material (L9), which in turn sealed post-Roman subsoil (L12) at a depth of approximately 1.1m. L12 sealed a thin layer of colluvium (L13) into which three archaeological features had been cut, ie two ditches (F45, F46) and an area of trample or erosion (F47).

Ditch F45 was aligned north-east to south-west, and shared this alignment with fragments of Roman ditches identified elsewhere in Area L/N and in other parts of the Garrison (CAT Reports 206 and 207). These ditches were fragments of the Late Iron Age and Roman agricultural landscape. Finds recovered from F45 were principally Roman, but included a residual prehistoric sherd.

Ditch F46 contained large quantities of post-medieval peg-tile and pottery and residual Roman material (tile fragments). Its alignment differed from the north-east to south-west alignment of the Roman landscape alignment, but matched the alignment and profile of other post-medieval ditches identified in Area L/N (F97 in T53 and F122 in T59). F46 is therefore likely to have formed part of a prominent agricultural landscape boundary pre-dating the construction of the Garrison. Another possibility is that it may be associated with Parliamentarian siegeworks of 1648, during the Civil War. This interpretation is given some weight by a gravel-rich basal deposit in the ditch which may indicate that the base of the ditch was trampled. There are known fortifications of this date in the northern half of the Abbey Field, and a fort was positioned on Mersea Road (siege map, CAT 1998).

The other feature identified in T12 was an erosion hollow (F47) on the north edge of post-medieval ditch F46. This also contained post-medieval peg-tile, and is, therefore, likely to be contemporary with ditch F46. A slight irregularity of profile in the base of the feature may be indicative of animal trampling occurring during the gathering of stock in the corner of a field. This interpretation would make it far more likely that F46 was an agricultural boundary than a fortification associated with the Civil War siege of Colchester.

Context	type	dated finds	period
F45	ditch	prehistoric pottery, Roman pottery and tile	Roman
F46	ditch	peg-tile, post-medieval pottery, slate	post-medieval

F47	erosion hollow	Roman pottery, ?peg-tile	post-medieval
-----	----------------	-----------------------------	---------------

Trench 13 (Figs 2, 4, 10, 13, 15, 17)

T13 was located on a tarmac road in the eastern half of Area L/N. T13 was split in two (T13a and T13b) to maintain access to the Recruiting and Cadet Force buildings (not shown on Fig 17).

Both trenches revealed ground affected by modern truncation associated with the construction of Goojerat Barracks in 1900-1902, as has been the case across much of the Area L/N evaluation site. Only occasional fragments of modern material (L9) were observed, and, throughout, the majority of the trench hard-top (L7) directly sealed natural glacial material (L5).

T13a contained two linear features (F48, F49) and a cluster of three post-holes (F59, F60, F63) at the south end of the trench at a depth of 0.6m. F48 shared a common alignment and profile with F45 in T12, and they both contained only Roman material. It seems likely, therefore, that both these features were the same ditch, and that both were part of the Roman landscape identified in the Area L/N evaluation and elsewhere across the Garrison. F49 had a very shallow profile, an irregular base, and a very fine silty fill. This would indicate that it was of natural origin, ie a post-glacial channel caused by glacial melt waters. The three post-holes at the southern end of T13a may have been structural. However, their proximity to what appears to be an agricultural feature (F48) indicates that they were probably part of a fence line associated with stock husbandry or pastoral farming rather than part of a building. Similar agricultural activity has been observed across the Garrison; for example, in GAL Areas S2 (south) and J2 (CAT Report 428; CAT Report 412 forthcoming).

Two modern foundations (F61 and F62) were identified in T13b, but no significant archaeological features were observed. The foundations were associated with the now-demolished 1900-1902 barracks, and were part of one of the main Goojerat Barracks Cookhouses shown on the RE 1949 plan (see Fig 17). Where modern footings can be identified, they are shown grey-toned on the trench plans (ie Figs 4-9).

Context	type	dated finds	period
F48	ditch	Roman pottery, burnt flints	Roman
F49	natural linear feature	-	undated
F58	post-hole	-	undated (?Roman)
F59	post-hole	-	undated (?Roman)
F60	post-hole	-	undated (?Roman)
F61	wall foundation	-	modern
F62	wall foundation	-	modern
F63	post-hole	-	undated (?Roman)

Trench 14 (Figs 2, 4, 11, 17)

T14 was located on tarmac in the eastern half of Area L/N. T14 revealed natural gravel at a depth of 0.5m and only a shallow depth of a modern soils (L12) survived below the hard-top (L7).

The trench contained a modern concrete foundation (F50), representing an area of Barrack Block A, which was part of the barracks demolished ahead of the rebuilding of Goojerat Barracks in 1971-75 (RE 1949 plan; see Fig 17). There was also a wide but shallow (0.5m deep and 2.8m wide) Roman ditch (F51) which contained pottery and tile, and which shared the same general alignment as other Roman landscape features identified in Area L/N. Its projected alignment ran at right-angles to the projected alignment of two other Roman ditches (F7 in T19 and F23 in T17). Together, these three ditches appear to have defined an enclosure, with F51 forming its western side. This ?enclosure may have been the focus of the local Roman agricultural landscape.

Context	type	dated finds	period
F50	wall foundation	-	modern
F51	ditch	Roman pottery and tile	Roman

Trench 15 (Figs 2, 4)

T15 was located on tarmac in the eastern half of Area L/N. In common with other parts of the evaluation site (and particularly the southern part), T15 appears to have been truncated, with modern hard-top (L7) directly sealing natural sand-and-gravel (L5) at a depth of 0.55m (ie the usual approx 0.30m of buried ploughsoil/ loamy sub-soil had been removed. No archaeological features were identified in T15.

Trench 16 (Figs 2, 4)

T16 was located on tarmac in the eastern edge of Area L/N. In common with other parts of the evaluation site (and particularly the southern part), T16 revealed a severely truncated sequence of deposits, with modern hard-top (L7) directly sealing natural sand-and-gravel (L5) at a depth of 0.37m. Any topsoils or other layers which may have existed here have been removed.

A single archaeological feature was observed (F52) cut by a modern service run (unnumbered) on the northern trench edge. F52 is likely to be natural in origin, possibly a post-glacial channel caused by melt waters.

Context	type	dated finds	period
F52	natural feature	-	undated

Trench 17 (Figs 2, 4, 12, 13)

T17 was located in a grassed area on the eastern edge of Area L/N. It was excavated through modern topsoil (L1) into post-Roman ploughsoil (L12). There was minimal evidence of modern disturbance. L12 sealed Roman ditch F23 at a depth of 0.32m. The ditch was 4.6m wide and 0.40m deep. F23 appears to have formed the northern edge of a rectangular ?enclosure, the western and eastern sides of which may be defined by ditch F23 in T19 and ditch F51 in T14 respectively.

Associated with ditch F23 was a group of eleven post-holes (F34-F44) located on the north side of the ditch and outside the ?enclosure. They probably represent an associated fence line, or a stock-related feature such as a holding pen.

The total weight of Roman building materials in T17 was 5.8kg. This may indicate the site of a nearby Roman structure in the ?enclosure.

Context	type	dated finds	period
F23	ditch	Roman pottery and tile	Roman
F34-F44	post-hole	-	undated (?Roman)

Trench 18 (Figs 2, 4)

Located in a grassed area in the central part of Area L/N, T18 was excavated through modern topsoil (L1) and modern accumulated soil (L12). Natural gravel was encountered at a depth of 1.05m. The trench was split into two sections to avoid a service run. The modern truncation seen elsewhere on Area L/N was minimal in T18, and natural sand-and-gravel (L5) was sealed by L12.

No archaeological features were observed in T18, although there were sporadic pockets of modern material compressed into the natural sand-and-gravels. These were patches of residual modern material probably associated with levelling episodes relating to the rebuilding of Goojerat Barracks in 1971-75.

Trench 19 (Figs 2, 4, 12)

Located in a grassed area in the eastern part of Area L/N, T19 was excavated through modern topsoil (L1) and modern accumulated soil (L2) sealing natural sand-and-gravel (L5) at a depth of 0.70m.

As has been previously observed, modern truncation is minimal in the eastern half of the evaluation site. There was, however, significant modern disturbance in the southern end of T19, where two large military pits (F11, F12) were recorded but left unexcavated due to possible EOD risk. During the initial excavation of the trench, the cap of a 2-inch mortar was recovered by the EOD engineer.

Other post-medieval features were a large post-medieval pit (F8) cut by a modern wall foundation (F10), which may have been a fragment of the now-demolished Regimental Institute (shown on the RE 1949 plan; see Fig 17). F8 cut a small Roman pit (F9).

The only significant archaeological feature was a north-east to south-west aligned ditch (F7) which was 1.60m wide and 0.86m deep. This contained significant quantities of Roman pottery and tile, and a large piece of worked greensand stone (the same material used in the construction of the Roman circus to the north-east of the evaluation site). The total weight of Roman ceramic building materials in T19 was 5.6kg. This may indicate the site of a nearby Roman structure.

F7 appears to have formed the western side of a rectangular enclosure, the northern and eastern sides of which may have been defined by ditch F23 in T17 and ditch F51 in T14 respectively.

The quantity of pottery recovered (21 sherds), in combination with the building materials, may indicate that there had been a Roman building in the immediate area, perhaps acting as the farmstead focus of the local Roman landscape.

Ditch F7 was cut by modern pit F24. This pit was not fully excavated due to the possible EOD risk.

Context	type	dated finds	period
F7	ditch	Roman pottery and tile, worked greensand	Roman
F8	pit	peg-tile, coal fragments (not recovered)	post-medieval
F9	pit	Roman tile	Roman
F10	wall foundation	-	modern
F11	military rubbish-pit	brick, paint tins (not recovered)	modern
F12	military rubbish-pit	brick, ammunition box (not recovered)	modern
F24	pit	plastic, coal fragments, slate, modern glass	modern

Trench 20 (Figs 2, 4, 15)

Located in a grassed area at the eastern edge of Area L/N, T20 was excavated through modern topsoil (L1), and into the modern accumulated soil (L2) which sealed natural sand-and-gravel (L5) at a depth of 0.45m. As previously mentioned, modern truncation was seen to be minimal in the eastern half of Area L/N.

T20 cut through a post-medieval ditch (F18) dated by the presence of post-medieval glass and clay tobacco-pipe stems in its middle fill. F18 probably represents part of the post-medieval agricultural landscape which pre-dated construction of the Garrison.

Two highly irregularly-shaped features (F19 and F21) were either natural features or tree-throw pits.

The trench also contained two post-holes (F20, F22) which may be of Roman date. These were isolated within the possible Roman enclosure, and may represent fence lines associated with animal husbandry or stock management.

Context	type	dated finds	period
F18	ditch	post-medieval glass, clay pipe (not recovered)	post-medieval
F19	natural pit or tree- throw pit	-	undated
F20	post-hole	Roman tile (not recovered)	Roman
F21	natural pit or tree- throw pit	-	undated
F22	post-hole	-	undated (?Roman)

Trench 21 (Figs 2, 4, 12, 14)

Located in a grassed area on the eastern edge of Area L/N, T21 was excavated through modern topsoil (L1) and into a layer of modern accumulated soil (L2) which sealed natural sand-and-gravel (L5) at a depth of 0.58m.

As previously mentioned, modern truncation was shown to be minimal in the eastern half of the evaluation site. T21 contained a gully (F13) dated to the post-medieval period by the presence of peg-tile in its middle fill. It probably represents part of the post-medieval agricultural landscape which pre-dated the construction of the Garrison.

Other features in T21 were a Roman ditch (F14), a Roman pit (F16) and a Roman post-hole (F15). The ditch (F14) was similar in size and profile to other ditches excavated in the Garrison, and is likely to have been part of a wider Roman agricultural landscape. Its north-south alignment is at odds with the general north-west/south-east alignment of Roman ditches in T17 and T19. The ditch may represent another phase or perhaps it linked up with the ditch in T19 at an oblique angle. Post-hole F15 cut the northern edge of ditch F14. It may have been part of a fence line associated with the ditch. Pit F16 contained Roman pottery and tile, and provides further evidence of Roman occupation here, associated with the ?enclosure which lies to the north of T21.

Context	type	dated finds	period
F13	gully	peg-tile, modern milk bottle	modern
F14	ditch	Roman pottery and tile, septaria	Roman
F15	post-hole	Roman pottery	Roman
F16	pit	Roman pottery and tile, intrusive post-medieval pottery	Roman

Trenches 22 and 23 (Figs 2, 5)

Located in a grassed area in the south-eastern corner of Area L/N, T22 and T23 were excavated through modern topsoil (L1) and into a layer of modern accumulated soil (L2) which sealed a thick, unnumbered layer of modern infill material containing modern brick and slate.

No archaeological features were observed in these trenches.

The natural sand-and-gravel exposed elsewhere in Area L/N (ie L5) were not seen in T22 or T23, nor were they detected in a number of auger probes taken at regular intervals along the length of the trenches (the auger was sunk to its maximum depth of 1.1m).

It seems that the southern corner of Goojerat Barracks has been subject to a massive amount of infill in the modern period, possibly to level up the bottom of the main valley at the bottom of the Abbey Field prior to the construction of the modern Garrison in the mid-late 19th century and early 20th century (see Fig 2).

Trench 24 (Figs 2, 5, 16)

Located in a grassed area in the south-eastern corner of Area L/N, T24 was excavated through modern topsoil (L1) and into a layer of modern accumulated soil (L2) which sealed natural sand-and-gravel (L5) at a depth of approximately 0.55m.

The position of T24 coincided with that of a large post-medieval quarry-pit (F25) containing peg-tile and post-medieval brick fragments. Only the northern edge of F25 was visible in the trench bottom.

The full profile of F25 could not be established because of its depth, but natural sand-and-gravel (L5) was recorded in a sondage at 1.8m below modern ground-level.

Context	type	dated finds	period
F25	quarry-pit	peg-tile, post-medieval brick, slate	post-medieval

Trench 25 (Figs 2, 5)

Located in a grassed area in the southern half of Area L/N, T25 was excavated through modern topsoil (L1) and modern accumulated soil (L2). L2 sealed an unnumbered deposit of dumped material which in turn sealed a modern road and footpath (F26). The road and footpath surface were a surviving fragment of the original infrastructure of Goojerat Barracks prior to the rebuilding of 1971-75.

Context	type	dated finds	period
F26	road/footpath	peg-tile, brick (not retained)	modern

Trench 26 (Figs 2, 5)

Located in a grassed area in the south edge of Area L/N, T26 was excavated through modern topsoil (L1) into a layer of modern accumulated soil (L2).

As in the case of T22 and T23, this trench showed that there has been a significant amount of infill and modern build-up in the south-eastern corner of Goojerat Barracks. A thick deposit of modern infill was recorded to a depth of 1.40m. Natural material (L5) was not observed in T26. No archaeological features were observed in this trench.

Trench 27 (Figs 2, 5, 17)

Located within the old tennis courts close to the south edge of Area L/N, T27 was excavated through modern hard-top (L7), which sealed a series of modern foundations (F57).

These foundations represent elements of the 1900-1902 barracks which were demolished in 1970-71 ahead of the extensive rebuilding of the barracks in 1971-75. The buildings can be identified as Block A of the Assaye Married Quarters (shown on the RE 1949 plan; see Fig 17). Natural levels could not be established because of the ubiquity of service runs associated with the building.

Context	type	dated finds	period
F57	wall foundation	-	modern

Trench 28 (Figs 2, 5, 13)

Located within the old tennis courts close to the south edge of Area L/N, T28 was excavated through modern hard-top (L7), which sealed accumulated soil (L8) which in turn sealed natural levels (L5) at a depth of 0.63m.

The single significant archaeological feature identified in T28 was a small ditch (F65) containing Roman tile, which was aligned south-west to north-east and was 0.90m wide and 0.34m deep. It shares this alignment with the two fragments of Roman ditch identified in T12/T13a and T14, approximately 200m to the NNE of T28. A projection of the apparent direction of F65 shows that it does not readily join

up with the end of either of the two Roman ditches just mentioned. However, the three ditches appear to show a consistent north-east to south-west alignment, and they may be considered as parts of a Roman landscape on that alignment (as recorded in other excavation and evaluation projects across the Garrison).

Context	type	dated finds	period
F65	ditch	Roman brick	Roman

Trench 29 (Figs 2, 5)

Located in a grassed area in the southern half of Area L/N, T29 was excavated through modern topsoil (L1), into a layer of accumulated modern subsoil (L6).

The south-west part of Area L/N has, at some point in the recent past, been subject to a high level of truncation. This became more apparent as trenching progressed westwards in Area L/N.

No significant archaeological features were recorded in T29. The only recorded features were a fragment of modern brick drain (F28), and a modern pit (F27) which was left unexcavated due to the potential EOD risk. Drain F28 was of a type which has been observed throughout the Garrison, and is an example of the remains of the original infrastructure and road layout of Goojerat Barracks prior to the rebuilding of 1971-75.

Context	type	dated finds	period
F27	pit	brick (not retained)	modern
F28	brick-lined drain	brick (not retained)	modern

Trench 30 (Figs 2, 5)

Located in a grassed area in the southern half of Area L/N, T29 was excavated through modern topsoil (L1), into a thin layer of accumulated modern subsoil (L6). This material sealed natural sand-and-gravel (L5) at a depth of 0.70m. As noted in other nearby trenches, there had been a slight degree of truncation in the south-eastern part of Area L/N. No significant archaeological features were observed in T30.

Trench 31 (Figs 2, 6, 14, 17)

Located in a grassed area in the southern half of Area L/N, T31 was excavated through modern topsoil (L1). The truncation observed throughout the south-western part of the evaluation site is clearly seen in T31, with modern topsoil L1 directly sealing natural sand-and-gravel (L5) at a depth of 0.28m.

Two modern wall foundations (F29, F30) were part of Block D of the Assaye Married Quarters, demolished after 1962 and shown on the RE 1949 plan (see Fig 17).

A single feature with an irregular cut and a leached-out fill was also identified at the southern end of the trench. This was either a natural pit or a tree-throw pit (F31).

Context	type	dated finds	period
F29	wall foundation	-	modern
F30	wall foundation	-	modern
F31	natural pit or tree-throw pit	-	undated

Trench 32 (Figs 2, 6)

Located in the south-western corner of Area L/N, T32 was excavated through modern hard-top (L7). The truncation observed throughout the south-western part of the evaluation site is clearly seen in T32, with modern topsoil L1 directly sealing natural sand-and-gravel (L5) at a depth of 0.35m.

No significant archaeological features were observed in T32.

Trench 33 (Figs 2, 6)

Located in the south-west corner of Area L/N, T33 was excavated through modern hard-top (L7). The south-western part of Area L/N has, at some point in the recent past, been subject to a high level of truncation. This truncation is clearly seen in T33, with modern hard-top L7 directly sealing natural sand-and-gravel (L5) at a depth of 0.33m. No significant archaeological features were recorded in T33.

Trench 34 (Figs 2, 6, 17)

Located in a grassed area in the southern half of Area L/N, T34 was excavated through modern topsoil (L1). The southern part of Area L/N has, at some point in the recent past, been subject to a high level of truncation. This is apparent in T34, where only a thin layer of accumulated modern subsoil (L6) survived. L6 sealed natural sand-and-gravel (L5) at a depth of 0.80m.

No significant archaeological features were observed in T34, but the partial remains of the wall foundations and concrete floor of a modern building were recorded (F32). These were part of the now-demolished 1900-1902 barracks, and are probably part of unnamed buildings to the south-east of the Sergeants' Mess (as shown on the RE 1949 plan; see Fig 17).

Context	type	dated finds	period
F32	wall foundation	-	modern

Trench 35 (Figs 2, 6, 14)

Located in the south-west corner of Area L/N, T35 was excavated through modern hard-top (L7). The south-western part of Area L/N has, at some point in the recent past, been subject to a high level of truncation. This truncation is clearly seen in T35, with modern hard-top L7 directly sealing natural sand-and-gravel (L5) at a depth of 0.40m.

Despite this high level of modern truncation, a cluster of undated post-holes survived (F53-F56, F64). These posts may have been structural, and their approximate north-south alignment indicates that they may have been part of a fence line associated with the Roman landscape defined by the ditch fragments excavated elsewhere in Area L/N.

Context	type	dated finds	period
F53	post-hole	-	undated (?Roman)
F54	post-hole	-	undated (?Roman)
F55	post-hole	-	undated (?Roman)
F56	post-hole	-	undated (?Roman)
F64	post-hole	-	undated (?Roman)

Trench 36

T36 was to have been located in the north-eastern corner of Area L/N, but was abandoned at the start of the evaluation work due to the presence of known and unplotted service runs. This decision was taken in consultation with RPS Planning. The lost meterage was made up elsewhere.

Trench 37 (Figs 2, 6)

T37 was located on tarmac close to the north-western edge of Area L/N. It cut two modern wall foundations (F66, F67) and several unnumbered modern service runs. The foundations relate to some of the buildings shown on the RE 1949 plan (ie the strip building north of the WO's Quarters on Fig 17).

There was, throughout the trench, a considerable depth of modern build-up (L14), into which the foundations had been cut. This material is likely to represent an episode of site levelling (perhaps of the former axial valley) prior to the rebuilding of Goojerat Barracks in 1971-75). It was excavated to a depth of 1.2m below ground-

level, below which level natural sand-and-gravel (L5) was identified by auger probing at a depth of 1.1m below the base of the trench (ie 2.3m below ground-level). The wall foundations were sealed by a layer of compacted modern hardcore and hard-top (L7).

Context	type	dated finds	period
F66	wall foundation	-	modern
F67	wall foundation	-	modern

Trench 38 (Figs 2, 6)

T38 was located on tarmac in the north-western part of Area L/N. Several unnumbered modern service runs (not shown on Fig 6) were identified throughout the trench, but no significant archaeological features were observed in T38.

As in T37, there was, throughout the trench, a considerable depth of modern build-up (L14), which is likely to represent an episode of site levelling prior to the rebuilding of Goojerat Barracks in 1971-75. This material was excavated to a depth of 1.2m below ground-level, below which natural sand-and-gravel (L5) was identified by auger probing at a depth of 1.1m below the base of the trench (ie 2.4m below ground-level). The modern service runs were sealed by a layer of compacted hardcore and hard-top (L7).

Trench 39 (Figs 2, 7)

T39 was located on tarmac in the north-western part of Area L/N. Several unnumbered modern service runs (not shown on Fig 7) were identified, but no significant archaeological features were observed in T39.

As in T37 and T38, there was, throughout the trench, a considerable depth of modern build-up (L14), which is likely to represent an episode of site levelling prior to the rebuilding of Goojerat Barracks in 1971-75. This material was excavated to a depth of 1.2m below ground-level, below which natural sand-and-gravel (L5) was identified by auger probing at a depth of 1.1m below the base of the trench (ie 2.2m below ground-level). The modern service runs were sealed by a layer of compacted hardcore and hard-top (L7).

Trench 40 (Figs 2, 7)

T40 was located on tarmac in the north-western part of the Area L/N. No archaeological features were observed in T40. Several unnumbered modern service runs (not shown on Fig 7) were identified, but there were no significant archaeological features in T40.

As in T37-T39, there was, throughout the trench, a considerable depth of modern build-up (L14), which is likely to represent an episode of site levelling prior to the rebuilding of Goojerat Barracks in 1971-75. This material was excavated to a depth of 1.2m below ground-level, below which level natural sand-and-gravel (L5) was identified by auger probing at a depth of 0.95m below the base of the trench (ie 2.15m below ground-level). The modern service runs were sealed by a layer of compacted hardcore and hard-top (L7).

Trench 41 (Figs 2, 7)

T41 was located on tarmac in the north-western part of Area L/N. T41 contained a modern wall foundation (F68), and a number of unnumbered modern service runs. The foundations match now-demolished structures shown on the RE 1949 plan as the Warrant Officers' Quarters (see WO's Quarters on Fig 17).

As in T37-T39, there was, throughout the trench, a considerable depth of modern build-up (L14), which is likely to represent an episode of site levelling prior to the rebuilding of Goojerat Barracks in 1971-75. This material was excavated to a depth of 1.2m below ground-level, below which natural sand-and-gravel (L5) was identified by auger probing at a depth of 1.05m below the base of the trench (ie 2.25m below

ground-level). Service runs and foundations were sealed by a layer of compacted hardcore and hard-top (L7).

Context	type	dated finds	period
F68	wall foundation	-	modern

Trench 42 (Figs 2, 7, 17)

T42 was located on tarmac on the northern edge of Area L/N. It contained a modern pit (F69), a modern wall foundation (F70), an undated pit (F71), and several unnumbered modern service runs (not shown in Fig 7).

The wall foundation matches an unnamed structure north of the Quartermaster's building (probably the Quartermaster's store), as shown on the RE 1949 plan (see QM's Quarters on Fig 17). The modern pit F69, which was almost certainly of military origin, was left unexcavated due to the possible EOD risk. F71 contained no artefacts, and is, therefore, likely to have been a natural pit, although charcoal flecking may indicate deliberate tree-stump removal during an episode of agricultural clearance.

Within the area covered by T42, T43 and T45, there was evidence of substantial truncation of surface levels, with topsoils and subsoils being almost totally removed (subsoil L2 survived only in occasional pockets). Thus, natural sand-and-gravel (L5) was identified at a depth of 0.57m just below the compacted hardcore and hard-top (L7). Service runs and foundations were sealed by a layer of compacted hardcore and hard-top (L7).

Context	type	dated finds	period
F69	pit	brick, coal (not retained)	modern
F70	wall foundation	-	modern
F71	natural pit or tree-throw pit	-	undated

Trench 43 (Figs 2, 7)

T43 was located on tarmac at the northern edge of Area L/N. No archaeological features were observed in T43. There was, however, evidence of substantial truncation of the surface levels, with topsoil (L1) and subsoil (L2) being almost totally removed (subsoil L2 survived only in occasional pockets). Natural sand-and-gravel (L5) was identified at a depth of 0.40m just below the compacted hardcore and hard-top (L7).

Trench 44 (Figs 2, 7)

T44 was located on tarmac at the northern edge of Area L/N. Truncation was less evident in T44 than in the trenches to the west (ie T42-T43, T45), although there was a significant level of modern build-up and dump material (L14) associated with the rebuilding of Goojerat Barracks in 1971-75.

A single modern pit was identified in the centre of the trench (F72). It was left unexcavated due to the possible EOD risk. Modern dump deposits were sealed by hard-top (L7). Natural gravel was encountered at a depth of 0.90m.

Context	type	dated finds	period
F72	pit	brick, asphalt (not retained)	modern

Trench 45 (Figs 2, 7)

T45 was located on tarmac at the northern edge of Area L/N. It showed evidence of extensive modern truncation (as observed in T42 and T43). Despite the modern truncation, two undated pits survived and were excavated (F75, F76). Neither feature contained artefacts, and they are therefore likely to have been natural pits.

However, charcoal flecking may indicate deliberate tree-stump removal during an episode of agricultural clearance.

Natural sand-and-gravel (L5) was identified at a depth of 0.15m, just below the compacted hardcore and hard-top (L7), with only fragments of subsoil remaining. This is clear evidence of the reduction of ground-level at the time of the rebuilding of Goojerat Barracks in 1971-75.

Context	type	dated finds	period
F75	natural pit or tree-throw pit	-	undated
F76	natural pit or tree-throw pit	-	undated

Trench 46 (Figs 2, 7, 17)

T46 was located on tarmac at the northern edge of Area L/N. Truncation was less evident here than in trenches to the west (ie T42, T43, T45), although there was a significant level of modern build-up and dump material (L14) associated with the rebuilding of Goojerat Barracks in 1971-75.

Sealed by L14 were two modern wall foundations (F73, F74). These consisted of concrete slabs with associated brickwork, and they were fragments of unnamed buildings north of the Quartermaster's building, built 1900-1902 (as shown on the RE 1949 plan (see QM's Quarters on Fig 17). Modern build-up (L14) was sealed by hard-top (L7). Natural gravel was encountered at a depth of 0.63m.

Context	type	dated finds	period
F73	wall foundation	-	modern
F74	wall foundation	-	modern

Trench 47 (Figs 2, 7)

T47 was located within a tarmac tennis court in the centre of Area L/N. No archaeological features were observed in T47.

As in T37-T41, T47 revealed a considerable depth of modern build-up (L14). This was excavated to a depth of 1.2m, below which a number of auger probes were taken to the maximum depth possible (ie 2.5m below ground-level) in an attempt to locate natural ground (ie L5). However, L5 was not located at the maximum auger depth. This may indicate that quarrying has taken place in this area, and that L14 (in T47 at least) is the backfill of the quarry-pits.

Modern build-up L14 was sealed by a layer of compacted hardcore and hard-top (L7).

Trench 48 (Figs 2, 7)

T48 was located within a tarmac tennis court in the centre of Area L/N. No archaeological features were observed in T48. As in T42-T47, throughout the trench there was a considerable depth of modern build-up (L14), which is likely to represent an episode of site levelling prior to the rebuilding of Goojerat Barracks in 1971-75. This material was excavated to a depth of 1.2m below ground-level, below which natural sand-and-gravel (L5) was identified by auger probing at a depth of 0.55m below the base of the trench (ie 1.75m below ground-level).

A comparison of the level at which natural ground has been located here and elsewhere in Area L/N shows that modern ground-level masks the pre-Garrison 'true' ground-level, which rises from north to south. In other words, true ground-level rises from the northern part of Goojerat Barracks (where there is evidence of infilling) to the southern and western parts of the barracks (where there is evidence of truncation). For example, between T37 and T48 (a north-to-south distance of approximately 100m), the level of natural L5 rises by 0.55m.

Trench 49 (Figs 2, 7, 13, 15)

T49 was located on tarmac in the eastern half of Area L/N. As in T37-T41 to the north, there was a substantial level of modern dump and build-up material here

(L14). However, this build-up was not so thick as that encountered to the south in T49-T55, with natural gravel encountered at a depth of 1.05m (L14 generally thins out from north to south in the northern part of Area L/N).

Three linear features were identified in T49. These were two undated ditches, ie F82 (0.60m wide and 0.30m deep) and F83 (0.88m wide and 0.26m deep), and a post-medieval ditch (F77).

The two undated ditches F82 and F83 may have come to a junction approximately 12m to the south of T49. They are not dated by finds, but their alignment matches that of the other Roman field ditches in T12 and T61. For that reason, they may be considered as having been parts of the same Roman landscape. F82 was heavily cut by a modern service run, so that only a partial section survived.

Post-medieval ditch F77 contained large quantities of peg-tile and residual Roman material. It probably formed a part of the medieval/post-medieval agricultural landscape which pre-dated the construction of the Garrison in the mid-late 19th and early 20th centuries.

In the west and central part of the trench were three natural pits (F79, F81, F84); these features were cut by modern service runs, and, in the case of F84, the modern foundation F78. The irregular profile and plan of these features indicates that they are either natural pits or tree-throw pits (minor charcoal flecking may favour the latter interpretation).

A single post-hole (F80) was identified on the edge of pit F79. The modern foundation (F78), of poured concrete and associated brickwork, probably represents remains of part of the Rifle Range, built 1900-1902, as shown on the RE 1949 plan (see Fig 17). Modern build-up and dump deposit L14 was sealed by L7 hard-top.

Context	type	dated finds	period
F77	ditch	peg-tile, Roman pottery and tile	post-medieval
F78	wall foundation	brick (not retained)	modern
F79	natural pit or tree-throw pit	-	undated (?Roman)
F80	post-hole	-	undated (?Roman)
F81	natural pit or tree-throw pit	-	undated (?Roman)
F82	ditch	-	undated (?Roman)
F83	ditch	-	undated (?Roman)
F84-F85	natural pit or tree-throw pit	-	undated

Trench 50 (Figs 2, 8, 14)

T50 was located on concrete on the western edge of Area L/N. The southern part of Area L/N has been massively truncated, probably at the time of the rebuilding of Goojerat Barracks in 1971-75. Truncation in T50 has removed all surviving subsoils in such a way that hard-top L7 sat directly on top of natural sand-and-gravel L5 at a depth of 0.15m.

However, despite this level of truncation, the bases of a number of features did survive. These were four pits (F101, F102, F104, F105) and a single post-hole (F103). Three of these pits (F102, F104, F105) had irregular cuts and leached-out fills, and appear to be natural in origin. The remaining pit (F101) contained no artefacts, but a concentration of charcoal on its west edge may indicate an anthropogenic origin.

The post-hole (F103) was shallow, but its upper fills are likely to have been removed by modern truncation.

All of the excavated features were sealed by the modern hard-top (L7).

Context	type	dated finds	period
F101	pit	-	undated
F102	natural pit	-	undated
F103	post-hole	-	undated (?Roman)
F104	natural pit	-	undated
F105	natural pit	-	undated

Trench 51 (Figs 2, 8, 14)

T51 was located on tarmac on the western edge of Area L/N. The southern part of Area L/N has been massively truncated, probably at the time of the rebuilding of Goojerat Barracks in 1971-75. Truncation in T50 has removed all surviving subsoils in such a way that hard-top L7 sat directly on top of natural sand-and-gravel L5 at a depth of 0.36m.

However, despite this level of truncation, the bases of three pits and a post-hole have survived.

Two of the pits (F90, F91) had irregular cuts and leached-out fills, and appear to be natural in origin. However, minor charcoal flecking may indicate deliberate tree-stump removal.

The other pit (F92) contained no artefacts but had a slight charcoal concentration in its middle fill.

The post-hole (F193) was shallow, but its upper fills are likely to have been removed by modern truncation. All of the excavated features were sealed by the modern hard-top (L7).

Context	type	dated finds	period
F90	natural pit or tree-throw pit	-	undated
F91	natural pit or tree-throw pit	-	undated
F92	pit	-	undated (?Roman)
F93	post-hole	-	undated (?Roman)

Trench 52 (Figs 2, 8, 15)

T52 was located on tarmac on the western edge of Area L/N. T52 (like T51) showed severe truncation of the latest levels, with hard-top surfacing (L7) sealing a thin skim of dumped material (L14) which in turn sealed natural deposit (L5) at a depth of 0.42m.

No significant archaeological features were observed in T52. Exposed features consisted of a large pit of military origin (F86), which was not excavated due to the potential EOD risk, and three service runs (F87, F88, F89) associated with the modern military buildings to the south and east.

Context	type	dated finds	period
F86	military rubbish-pit	brick, iron fragments (not retained)	modern
F87	service run	brick, peg-tile (not retained)	modern
F88	service run	brick, peg-tile (not retained)	modern
F89	service run	brick, peg-tile (not retained)	modern

Trench 53 (Figs 2, 8, 14)

Located on tarmac in the western part of Area L/N, T53 marked the area where the underlying topography of the Goojerat Barracks changes. At the north end of T53, the natural level dropped away into the infilled area to the north (ie in the area sampled by T49 and T40). To the south, natural level rose towards T54 to a depth of 0.56m and T55, where the modern ground-level is at an artificially created level. In T53, modern dump material L14 sealed a thinning layer of surviving accumulated soil L8.

Significant archaeological remains in T53 consisted of three pits (F96, F99, F106) and one ditch (F97). Pits F96 and F99 had highly irregular cuts and leached-out fills, and appear to be natural in origin or possibly tree-throw pits. Pit F106, which contained Roman tile, was located in the middle of a Roman field system. Pits normally indicate some level of occupation, and it remains unclear whether this pit

was domestic or agricultural in function, although the latter is likely given the paucity of finds.

Ditch F97 was aligned east to west and contained post-medieval pottery and peg-tile (with residual Roman tile). This feature shared a common alignment with F46 in T12, and may represent post-medieval agricultural activity which pre-dated the construction of the Garrison), or a ditch associated with the Civil War siege of Colchester of 1648.

Apart from the pits and ditch (above), other remains consisted of four modern foundations (F94, F95, F98, F100). These were of concrete and brick, and were parts of an unidentified building west of Barrack Block D of Goojerat Barracks, as shown on the RE 1949 plan (see Fig 17).

Context	type	dated finds	period
F94	wall foundation	-	modern
F95	wall foundation	-	modern
F96	natural pit or tree-throw pit	-	undated
F97	ditch	late medieval pottery, peg-tile, Roman brick and tile	late medieval or post-medieval
F98	wall foundation	-	modern
F99	natural pit or tree-throw pit	-	undated
F100	wall foundation	-	modern
F106	pit	Roman tile	Roman

Trench 54 (Figs 2, 8)

T54 was located on tarmac at the western side of Area L/N. No archaeological features were observed in T54. There was, however, evidence of substantial truncation, with topsoil and subsoil being almost totally removed. Natural sand-and-gravel (L5) was identified at a depth of 0.60m just below the compacted hardcore and hard-top (L7) with subsoil remaining only as occasional patches (L9). This truncation has been observed in a number of locations across Area L/N and is probably associated with the rebuilding of Goojerat Barracks in 1971-75.

Trench 55 (Figs 2, 8)

T55 was located on tarmac in the western central part of Area L/N, and in the Quartermaster's compound. No archaeological features were observed in T55. There was, however, evidence of substantial truncation, with topsoil and subsoil being almost totally removed. Natural sand-and-gravel (L5) was identified just below the compacted hardcore and hard-top (L7) with subsoil remaining only as occasional patches (L9). This truncation has been observed in a number of locations across Area L/N and is probably associated with the rebuilding of Goojerat Barracks in 1971-75.

Trench 56

It was the intention to locate T56 in the centre of Area L/N, but it was decided, in consultation with RPS Planning, not to cut this trench because of the presence of military storage containers and laagered vehicles. The lost meterage was added to T60, T61 and T62b.

Trench 57 (Figs 2, 8)

T57 was located on tarmac in the Parade Ground of Area L/N. As was the case with T53, this trench marked a change in the underlying topography of Area L/N. The depth of surviving archaeological strata was seen to increase in the trenches to the north of T57, and to diminish in the trenches to the south.

Natural sand-and-gravel (L5) was identified at 1.1m below ground-level, where it was sealed by accumulated soil L9. This accumulation suggests that the trench lay within the axial valley also recognised in T10, T11, T12, T58 and T60.

T57 contained two natural pits F120 and F121. These had irregular cuts and leached-out fills, and contained no finds. They were either pits of natural origin, or three-throw pits (some minor charcoal flecking in F120 may indicate deliberate tree-stump removal during a period of agricultural clearance).

Context	type	dated finds	period
F120	natural pit or tree-throw pit	-	undated
F121	natural pit or tree-throw pit	-	undated

Trench 58 (Figs 2, 8)

T58 was located on tarmac in the Parade Ground of Area L/N. Like T53, this trench marked a change in the underlying topography of Area L/N. The stratigraphy observed in T58 was consistent with that observed in T4, T5 and T6 to the immediate north-west.

No archaeological features were observed in T58, but the trench showed a considerable depth of infill (make-up and modern accumulated layers L14, L9 and L10). This infill was excavated to a depth of 1.2m below ground-level. This accumulation suggests that the trench lay within the axial valley also recognised in T10, T11, T12, T57 and T60. Following this, a series of auger probes established the level of natural sand-and-gravel L5 at a depth of 0.6m below trench bottom (a total depth of 1.8m below ground-level).

Trench 59 (Figs 2, 9, 15, 17)

T59 was located in the Parade Ground of Area L/N. As was the case with T50, T51 and T52, T59 showed evidence of considerable modern truncation. This meant that archaeological horizons had been almost totally removed, leaving only a thin layer of (L9) sealed by modern hard-top (L7). Natural L5 was exposed at a depth of 0.40m.

The only significant archaeological feature was an east-west aligned ditch (F122). This contained post-medieval tile, and shared a common alignment and profile with F97 in T52 and with F46 in T12. F122 may represent a major land division, or possibly a part of the Civil War siegeworks of 1648 associated with the fort on Mersea Road.

Modern foundations were recorded at the south end of the trench (F123). These represent parts of the now-demolished 1900-1902 barracks, and may have been parts of Barrack Block D of Goojerat Barracks, as shown on the RE 1949 plan (see Fig 17).

Context	type	dated finds	period
F122	ditch	peg-tile, Roman tile	post-medieval
F123	wall foundation	-	modern

Trench 60 (Figs 2, 9, 13)

T60 was located on tarmac in the Parade Ground of Area L/N. The archaeological strata had not been heavily truncated here, so a thickness of accumulated soil L12 survived, sealing archaeological features and natural sand-and-gravel (L5) at a depth of 0.83m. This accumulation suggests that the location lay within the axial valley also found within T10, T11, T12, T57 and T58.

Significant archaeological features consisted of two ditches, F119 and F124. F119 was undated, but its alignment matched the alignment of the Roman landscape as shown in ditches F107 in T61 to the south-west and F48 in T13 to the south-east. Ditch F124 contained Roman tile and a single *tessera* cube. However, the exact alignment of this ditch with F122 in T59 to the west and with F46 in T12 to the east means that there is very little doubt that this is the same ditch, and that the

Roman finds were residual. The ditch had been truncated by modern service runs on both edges, and it proved impossible to obtain a complete section of the feature.

Two pits (F112, F113) at the north end of the trench had leached-out silty fills. They may be natural pits or tree-throw pits.

Context	type	dated finds	period
F112	natural pit or tree-throw pit	-	undated
F113	natural pit or tree-throw pit	-	undated
F119	ditch	-	undated but probably Roman
F124	ditch	(residual) Roman tile and tessera	post-medieval

Trench 61 (Figs 2, 9, 13)

T61 was located on tarmac in the Parade Ground of Area L/N. As was the case with T50, T51 and T52, T61 showed evidence of considerable modern truncation. This meant that archaeological horizons had been almost totally removed, leaving only a thin layer of (L9) above natural gravel at a depth of 0.45m, sealed by modern hard-top (L7).

Grubbed-out modern foundations (F108) at the north end of the trench represent part of the now-demolished 1900-1902 barracks, possibly part of one of the Goojerat Barracks Cookhouses shown on the RE 1949 plan (see Fig 17). Significant archaeological remains consisted of a ditch (F107) and a post-hole (F109). Ditch F107 was 0.57m wide and 0.28m deep and was aligned south-west to north-east. It contained no artefacts but had a slight charcoal concentration in the middle fill. Although undated, it shared an alignment with the Roman landscape, as shown by other Roman ditches in T60 and T13.

The upper fills of post-hole F109 had been removed by modern truncation. Its profile was similar to that of other post-holes in T51 and T49, and they may all represent parts of fence lines or hurdles used in stock management.

The lower, leached-out fill and irregular cut of pit F110 may indicate a natural origin.

Context	type	dated finds	period
F107	ditch	-	undated (?Roman)
F108	grubbed-out wall foundation	-	modern
F109	post-hole	-	undated (?Roman)
F110	natural pit	-	undated

Trench 62 (Figs 2, 9)

T62 was located in the Parade Ground of Goojerat Barracks, and was dug in two parts (T62a, T62b) to allow access to the 216 Signal Squadron workshops

As was the case in T50, T51 and T54, T62 shows considerable modern truncation which has removed the upper strata and left only a thin layer of surviving accumulated soil (L9) sealed by modern hard-top (L7). Natural was present at 32.68m.

T62a contained a single natural feature or tree-throw pit F111, whose upper fills had been removed by modern truncation. T62b contained three natural pits or tree-throw pits (F114, F17, F118), the upper fills of which had been removed by modern truncation.

T62b cut across the lines of two modern foundations (F115, F116). F115 had been removed completely, but the poured-concrete base and brickwork of F116 remained *in situ*. These foundations represent now-demolished elements of the original 1900-1902 barracks, demolished in 1970-71 ahead of the rebuilding of Goojerat Barracks in 1971-75. The foundations were probably parts of the

Cookhouse shown on the RE 1949 plan between Barrack Blocks B and A (see Fig 17).

It is notable that the deep ditch in T19 to the south-east did not continue into this trench which suggests that the ditch turned or terminated before T62.

Context	type	dated finds	period
F111	natural pit or tree-throw pit	-	undated
F114	natural pit or tree-throw pit	-	undated
F115	grubbed-out wall foundation	-	modern
F116	wall foundation	-	modern
F117- F118	natural pit or tree-throw pit	-	undated

6 Finds

6.1 The small finds and bulk metalwork

by Nina Crummy

The finds in this small assemblage range in date from Iron Age or Roman to 20th century. A small pruning-hook came from Roman ditch F7, together with a limestone block that may have been reused as a grave or boundary marker. A small polishing stone made from a reused fragment of a Mayen lava quernstone is the first such Roman piece from Colchester, although there is a medieval example from the town. Quern stones made from this type of stone were imported in the Roman, medieval and early post-medieval periods, so that parallel examples of reuse for broken fragments need not necessarily be considered as unusual. The remaining items are post-medieval or modern.

SF 51. (4) F7. Roman ditch. Fragment of a small socketed curved iron blade, probably a pruning-hook (Manning 1985, 56-7). Length 70 mm.

SF 45. (16) F7. Roman boundary ditch. Long narrow slightly tapering rectangular block of banded limestone. One surface and the wider end are worked smooth. The remaining surfaces are all rough, although both sides are worn and are aligned more or less at 90 degrees to the wider end. The narrower end is broken, and the underside is very rough and may also be a secondary break. Maximum dimensions 535 by 155 by 80 mm. The stone is British but not local, and was probably imported for use in an architectural feature, such as a lintel, threshold or window embrasure. Rough blocks were also used as boundary and grave markers in both the Roman period, although none has been found *in situ* in Colchester to demonstrate the practice here.

SF 42. (17) F23. Roman ditch. Fragment of a polishing stone made from a piece of a Mayen lava quernstone worked into a small rectangular block, two sides are damaged. A similar palm-sized polishing stone of medieval date was found at St Mary Magdalen's hospital in Colchester (Crummy 2003, 142, fig 24, B.1). 66 by 75 mm, 36 mm thick.

SF 48. (25) F23. Roman ditch. Four small fragments of Mayen lava, one a corner from a rectangular block. Probably part of SF 42 above. Total weight 45 g.

SF 41. Unstratified. Fragment of a tapering copper-alloy D-section bar, possibly part of an Iron Age or Roman armet. Diameter approximately 85 mm, height 7 tapering to 5.5 mm, width 4 mm.

(14) F18. Post-medieval ditch. Iron hobnail. Length 20 mm.

(34) F47. Post-medieval hollow, associated with ditch F46. Incomplete iron nail and a nail shank fragment. Lengths 41 and 23 mm.

SF 46. (35) F46. Post-medieval ditch. Three small chips of Mayen lava. Total weight 3 g.

SF 43. (36) F46. Post-medieval ditch. Abraded fragment of Mayen lava. Weight 93 g.

SF 50. (35) F46. Post-medieval ditch. Tapering fragment of Millstone Grit with two worked edges set at an obtuse angle; the other surfaces are worn but slightly irregular. Probably part of a quernstone that has been reused as building stone or as a polishing stone. 82 by 67 mm, maximum thickness 37 mm.

SF 47. (26) F33. Modern military rubbish pit. a) Fragment of iron sheet with two straight edges set at right angles. 77 by 57 mm. b) Fragment of U-section binding or the socket from a tool. Length 38 mm, height 27 mm, width 24 mm.

(26) F33. Modern military rubbish-pit. Complete iron nail. Length 77 mm.

SF 49. (19) F24. Modern military rubbish-pit. Screw-type beer bottle stopper, marked TOLLY with Patent 1923 above and No 213852 below. Height 41 mm, maximum diameter 30 mm. Tolly beers had their origins in a takeover of the Ipswich Brewery in 1880 by the Tollemache family of Suffolk, while a merger with Cobbold & Co. in 1957 to form Tolly Cobbold marks the loss of the sole name. This stopper therefore dates to between 1923 and 1957.

6.2 The metal-working debris

by Nina Crummy

All these fragments came from the same area but are so few in number that they must be residual. The fragments of tap slag point to iron smelting in the vicinity, while the undiagnostic pieces of slag may come from either smelting or smithing.

(35) F46. Post-medieval ditch. Two tap slag fragments and one fragment of undiagnostic slag. Total weight 86 mm.

(34) F47. Post-medieval hollow, associated with F46. Fragment of undiagnostic iron-working slag. Weight 208 g.

(37) F47. Post-medieval hollow, associated with F46. Four fragments of undiagnostic slag. Total weight 107 g.

6.3 The clay tobacco pipes

by Nina Crummy

Only one datable piece is present, a bowl of Colchester Type 7, c 1670-1700 (CAR 5, 49).

(26) F33. Plain stem fragment. Length 53 mm, stem bore 2.5 mm.

(35) F46. Bowl and four plain stem fragments. a) Incomplete bowl of Type 7, with a line across the foot; only the rim is missing. Height 43 mm, stem bore 2.5 mm. b) Length 35 mm, stem bore 2.5 mm. c) Length 44 mm, stem bore 3 mm. d) Length 38 mm, stem bore 3 mm. e) Length 31 mm, stem bore 2.5 mm.

(3) L6. Two plain stem fragments. a) Length 42 mm, stem bore 3 mm. b) Length 44 mm, stem bore 3 mm.

6.4 The prehistoric, Late Iron Age and Roman pottery

by S Benfield

Introduction

There was one small sherd of prehistoric pottery (weighing 1g) and just under 1kg (916 g) of Roman pottery. Of the Late Iron Age and Roman pottery, 415g was recovered from contexts dated as Roman and 501g was residual in post-Roman contexts. The prehistoric sherd is discussed separately and described separately in Table 3. The Roman pottery was recorded using the Roman pottery fabric type series devised for CAR 10, in which the fabrics are recorded as two-letter codes. The letter codes, together with the full fabric name, are set out in Table 2. Additional codes for Late Iron Age grog-tempered ware (Fabric GTW) and Romanising coarse wares (Fabric RCW) have been introduced and these fabric types are described below. A separate code for *terra rubra* (Fabric TR) has also been used as small quantities of *terra rubra* recovered from the Roman town were incorporated in CAR 10 under Fabric DZ (CAR 10, 253). Where appropriate, the fabric code for the

National Roman Fabric Reference Collection has been included (Tomber & Dore 1998). The pot forms were recorded, where possible, using the Camulodunum (Cam) Roman pottery form type series (Hawkes & Hull 1947; Hull 1958). Samian vessels are recorded using Dragendorff (Dr) form numbers or other common form type references following those used in Webster 1996. The pottery fabrics and the vessel forms present in each site context were recorded for each finds number. The number of sherds was recorded and the identifiable pottery forms present for each fabric type were recorded. The total weight of pottery and a spot date was recorded for each finds number. This information is set out in Tables 4 and 5.

Fabrics and descriptions additional to CAR 10 fabrics used in this report:

Fabric GTW

Late Iron Age grog-tempered wares. Generally thick sherds with patchy red-brown, brown or grey-brown surfaces. Fabric contains various quantities of crushed fired clay (grog).

Fabric RCW

Romanising coarse ware. Sherd thickness is generally medium to thin. Surfaces are dark grey-brown. The fabric is grey-brown with red-brown margins and contains fragments of burnt organic matter and grog. The fabric sometimes has a tendency to laminate.

Table 2: Roman pottery fabric codes and fabric names used in this report (after CAR 10).

Fabric code	Fabric name	National Roman Fabric Reference Collection fabric
AA	amphoras, all excluding Dressel 20 and Brockley Hill/Verulamium amphoras	
AJ	amphoras, Dressel 20	BAT AM 1/2
BA	plain samian forms (unsourced)	
SG	South Gaulish plain samian	LGF SA
CG	Central Gaulish plain samian	LEZ SA 2
DJ	coarse oxidised and related wares	
DZ	fine oxidised wares	
EA	Nene Valley colour coated wares	LVN CC
GTW	grog-tempered wares	SOB GT
GX	other coarse wares, principally locally-produced grey wares	
HD	shell-tempered and calcite-gritted wares	
HZ	large storage jars and other vessels in heavily-tempered grey wares	
KX	black-burnished ware (BB2) types in pale grey ware	
RCW	Romanising coarse ware	
TR	<i>terra rubra</i>	

Prehistoric pottery table and discussion

There was one small sherd of flint-tempered prehistoric pottery from F45 in T12 (finds no 32). The sherd cannot be more closely dated than prehistoric – pre-Belgic, that is, prior to the introduction of Late Iron Age grog-tempered ware c 50-25 BC (Lavender 2007, 62; Sealey 2007, 31).

Table 3: the prehistoric pottery.

Trench	context number	finds number	weight (g)	sherd description and date
T12	F45	32	1	small flint-tempered sherd flake, one surface flaked away, red fabric. Prehistoric.

Late Iron Age and Roman pottery tables and discussion

The total quantity of pottery, at just under 1 kg, is small. The date range of the pottery, based on the more closely datable sherds, is c 50/25 BC-4th century AD. It should be noted that much of this pottery, both from contexts dated as Roman and

residual from post-Roman contexts, showed various degrees of abrasion and that the assemblage consists almost entirely of small or small to medium-sized sherds.

Possibly the most interesting aspect of the pottery is the presence of a number of sherds in fabric types typical of the Late Iron Age, and also typical of assemblages from the Sheepen site (Hawkes & Hull 1947; Niblett 1985). The Sheepen site is dated c 5 BC-AD 60 (Niblett 1985, 3). There are two sherds in grog-tempered ware: Fabric GTW, from F48 in T13 (finds no 28) and L6 in T9 (finds no 3); three sherds from a Cam 254 cooking pot in Fabric HD, from F24 in T19 (finds nos 19 and 22); and two sherds of *terra rubra* or Fabric TR, from F7 in T19 (finds no 11) and F24 in T19 (finds no 19). There are also six sherds in Romanising coarse ware (Fabric RCW): four sherds from F24 in T19 (finds no 19), which include the bowl form Cam 218, one sherd from L6 in T9 (finds no 3) and one from F15 in T21 (finds no 9), the fabric of which contains sparse grog-temper.

Although small in quantity (only 75 sherds were derived from clearly Roman contexts), this pottery is of some significance, as, in general, the Colchester Garrison sites have produced very little pottery that can be dated to the Late Iron Age, a point that has been noted (Sealey forthcoming). The grog-tempered wares are typical of the Late Iron Age. These cannot be more closely dated than c 50/25 BC-AD 43 (Sealey 2007, 31). While it is just possible that the form Cam 254 cooking pot is post-conquest, only two examples have been recovered from the Roman town and they are clearly a pre-conquest – Late Iron Age – pottery type. *Terra rubra* was imported into Britain from c 15 BC (Tyers 1996, 165). Some *terra rubra* has been recovered from assemblages in the Roman town, but it is very scarce there and it is clearly largely, if not almost entirely, a pre-conquest import (CAR 10, 490). *Terra rubra* certainly does not appear to be current after c AD 50/55 as it is absent from stratified deposits in London where occupation is thought to date from the AD 50s (Davies *et al* 1994, 166). While not so closely datable, Romanising coarse ware is also typical of the Sheepen assemblages and is the main fabric type among the assemblages from the enclosure ditches at Stanway (Enclosures 3-5) dated c AD 35-40 to 50/60 (Crummy *et al* 2007, 440-41).

However, all of the pottery dated as Late Iron Age was recovered from contexts that also contained pottery dated to the post-conquest (Roman) period.

Of the pottery from contexts dated as Roman, bearing in mind the small quantities of pottery recovered and the fact that many sherds showed some signs of abrasion or wear, only one feature (F23 in T17) contained pottery that need date later than the 1st century or 1st-early 2nd century. Some of the sherds recovered from F23 (finds no 20) are from a Central Gaulish flanged bowl of form Dr 38, which can be dated as 2nd century but is more typical of the later 2nd century (Webster 1996, 51). The small number of more closely-datable sherds from the other features have either a broad 1st- to 2nd-/3rd-century date range, ie Fabrics DJ, HZ and AA (Gaulish amphoras), or are of Late Iron Age and early Roman date, ie Fabrics GTW and RCW. Typical 2nd- to 3rd-century fabric types, such as BB1 and BB2: black-burnished wares category 1 and 2, and late Colchester colour-coat ware, were not recorded, although one sherd in grey ware imitating a black-burnished ware form was recorded among the residual pottery (see below). The remainder of the pottery consists of body sherds from locally-produced grey ware pots and cannot be more closely dated other than as Roman.

The composition of the residual Roman pottery recovered from post-Roman contexts is similar to that from the contexts dated as Roman, and the same comments on dating apply as for the pottery from the Roman dated contexts. There are two sherds that can be closely dated to later than the 1st century. One sherd, from F46 in T12 (finds no 31), is from a Cam 37/38 bowl in a pale grey ware imitating a black-burnished ware pottery form type (Fabric KX). The bowl rim is a half-round bead and the pot can be dated to the late 2nd to mid-late 3rd century. The second sherd, from F18 in T20 (finds no 14), is very abraded, but retains some of its original dark colour-coat. The fabric of the sherd suggests that it is a product of the Nene Valley potteries (Fabric EA) and can be dated to the early-mid 3rd to 4th century, probably after c AD 275 (CAR 10, 279).

Table 4: Roman pottery from Roman-dated contexts.

Trench	context number	finds number	weight (g)	Roman pottery fabrics (with number of sherds and dated form types)	Roman pottery spot-date
T19	F7 Sx 1	4	40	Fabric GX, 14 sherds, 3 sherds from the rim and neck of a jar or bowl, 2 joining in grey fabric - 4 sherds from the upper body of a jar or bowl with a single row of stab decoration below a cordon in similar grey fabric - 4 other sherds in similar grey fabric - 2 sherds from 2 other pots, Roman ?1st-2nd century.	Roman, ?1st-2nd century
T19	F7 Sx 2	5	18	Fabric HZ, 1 sherd flake, one surface missing, 1st-2nd/3rd century.	1st-2nd/3rd century
T19	F7 Sx 3	11	49	Fabric TR (<i>CAR 10</i> , Fabric DZ - <i>terra rubra</i>), 1 sherd from a closed vessel, pale-red fabric with a darker brownish-red matt slip, pre-Flavian - Fabric GX, 4 sherds, Roman.	Roman, ?pre-Flavian
T19	F7 Sx 1	21	19	Fabric GX, 1 sherd, Roman.	Roman
T19	F7	39	33	Fabric DZ, 1 sherd in cream-white fabric, 1st-2nd century - Fabric GX, 1 sherd, Roman - Fabric HZ, 1 sherd, 1st-2nd/3rd century.	1st-2nd/3rd century
T19	F23	20	55	Fabric BA(CG), 4 sherds probably from one pot, Dr 38 flanged bowl early 2nd-late 2nd century, probably later 2nd century - Fabric GX, 5 sherds, 1 sherd burnt, Roman - Fabric HZ, 1 sherd, 1st-2nd/3rd century.	2nd century, probably later 2nd century
T17	F23	23	6	Fabric GX, 1 sherd, abraded, Roman.	Roman
T12	F45	32	38	Fabric GX, 6 sherds, abraded, Roman	Roman
T12	F45	32	1	Small flint-tempered prehistoric sherd flake, one surface flaked away, red fabric.	prehistoric
T13	F48	28	26	Fabric GTW, 1 sherd, Late Iron Age - Fabric DJ or oxidised Fabric GX, sandy fabric, 2 sherds, Roman.	Roman
T14	F51	29	32	Fabric ?HZ, 1 sherd, thick, soft and abraded, some grog-temper, possibly from a large storage jar, Roman.	Roman, probably 1st-2nd century.
T17	F23	18	12	Fabric BA(SG), 1 sherd, very abraded, 1st century - Fabric GX, 4 sherds, Roman.	Roman
T21	F14	7	42	Fabric ?AA, 1 sherd, probably from a Gaulish amphora, 1st-early 3rd century - Fabric DJ, 1 sherd, 1st-2nd/3rd century -	1st-2nd/3rd century

Trench	context number	finds number	weight (g)	Roman pottery fabrics (with number of sherds and dated form types)	Roman pottery spot-date
				Fabric GX, 3 sherds, 2 from one pot are possibly 1st-2nd century, Roman ?1st-2nd century.	
T21	F14	8	44	Fabric GX, 5 sherds, Roman.	Roman
T21	F15	9	27	Fabric RCW, 1 slightly abraded sherd, Late Iron Age or early Roman - Fabric GX, 1 sherd, Roman - Fabric HZ, 1 sherd, 1st-2nd/3rd century.	Roman, 1st-2nd/3rd century
Total			416		

Table 5: Roman pottery from post-Roman dated contexts.

Trench	context number	finds number	weight (g)	Roman pottery fabrics (with number of sherds and dated form types)	Roman pottery spot date
T19	F24	19	92	Fabric TR (<i>CAR 10</i> , Fabric DZ - <i>terra rubra</i>), 1 moderately large body sherd from a large closed vessel, pale-red slightly sandy fabric with slightly darker brownish-orange matt slip, see also F7 finds no 11, pre-Flavian - Fabric RCW, 4 sherds, Cam 218 bowl, 1st century - Fabric HD, 2 sherds from a Cam 254 cooking pot, Late Iron Age-?early Roman.	early Roman, pre-Flavian
T19	F24	22	47	Fabric HD, 1 rim sherd from a Cam 254 cooking pot, Late Iron Age-?early Roman.	
T12	F46	33	10	Fabric HZ, 1 sherd, 1st-2nd/3rd century.	
T12	F46	35	106	Fabric AA, 2 abraded sherds, one sherd possibly re-worked into a rough cube shape, 1st-2nd/early 3rd century - Fabric BA(SG) 1 sherd flake, one surface missing, 1st century - Fabric ?DJ, 1 sherd with fragment of small raised boss at edge of sherd above groove around body, ?1st-2nd century - Fabric GX, 2 sherds, 1 sherd from a lid (lids are probably more common from the 1st-2nd century).	1st-2nd century, ?1st century
T12	F47	37	32	Fabric GX, 3 sherds, Roman - Fabric ?HZ, thick sherd flake either from a large storage jar or possibly a tile.	
T5	F33	26	7	Fabric GX, 1 sherd from a base, Roman.	
T9	L6	3	35	Fabric GTW, 1 sherd, contains dark grog temper, Late Iron Age - Fabric RCW, 1 sherd, 1st century - Fabric GX, 1 sherds, Roman.	early Roman, 1st century
T11	L12	30	18	Fabric DJ, 2 sherds, sandy fabric, possibly oxidised Fabric GX, Roman -	

Trench	context number	finds number	weight (g)	Roman pottery fabrics (with number of sherds and dated form types)	Roman pottery spot date
				Fabric GX, 2 sherds, Roman.	
T12	F46	31	44	Fabric GX, 3 sherds, Roman - Fabric KX, 1 sherd Cam 37/38B bowl, with half-round rim bead, late 2nd to third quarter of the 3rd century.	late 2nd to third quarter of the 3rd century
T20	F18	14	1	Fabric ?EA, 1 small sherd, very abraded, with dark colour-coat surviving on inner surface, early-mid 3rd to 4th century, probably late 3rd-4th century.	early-mid 3rd to 4th century, probably late 3rd-4th century
T21	F16	10	34	Fabric GX, 2 rim sherds, recently broken, from a jar or bowl, Roman.	
T37	L9	40	14	Fabric GX, 5 sherds, Roman.	
T49	F77	44	9	Fabric GX, 1 sherd, Roman.	
T49	L12	43	16	Fabric GX, 2 sherds, Roman.	
T60	L13	47	36	Fabric GX, 1 abraded sherd, probably from a pot base, Roman.	
Total			501		

6.5 Catalogue of the post-Roman pottery

by Howard Brooks

Post-Roman pottery fabric descriptions are after *CAR 7*. This is a small group (24 sherds, weighing 188g). None of this material is in significant groups or locations. The medieval sherds were all residual in post-medieval features.

The largest group of post-Roman pottery (14 sherds, 100g) was from the E-W ditch F46 and associated erosion hollow F47. Other sherds are from a post-medieval ditch F77, a modern military rubbish pit F33, post-medieval pit F2, and post-medieval soil layers L6 and L9.

T5

F33, Finds number 26

3 sherds of post-medieval red earthenware (PMRE; Fabric 40) inc 1 base, 49g; 1 Frechen ware (Fabric 45), 22g

T8

F2, Finds number 1

1 sherd of PMRE (Fabric 40), 2g

F3, Finds number 2

1 sherd of Fabric 20, 4g

T12

F46, Finds number 31

1 medieval sherd, either Fabric 13 or Fabric 20, 5g

1 sherd of Frechen ware (Fabric 45d), 11g

1 sherd of Westerwald ware (Fabric 45f), 3g

F46, Finds number 33

3 medieval sherds, probably Fabric 20, 27g

5 sherds of PMRE (Fabric 40), 27g

F47, Finds number 37

3 medieval sherds, probably Fabric 20, 27g

T21

F16, Finds number 10

1 sherd of PMRE (Fabric 40), 2g (intrusive?)

T49

F77, Finds number 42

1 sherd of Colchester-type ware (Fabric 21a), 3g

Layers

L6, Finds number

1 sherd of modern ironstone (Fabric 48d), 2g

L9, Finds number 40

1 glazed sherd of Surrey white ware (Fabric 23) or Border ware? (Fabric 42), 4g

6.6 Catalogue of Roman and later ceramic finds and building materials

by H Brooks

This section consists of a summary table (Table 6) and a catalogue of ceramic and other building materials, with a brief comment on its distribution (D = discarded).

Table 6: summary of brick and tile types by trench (weights in g).

Trench	Tegula		Imbrex		Roman brick		Tesserae		Peg-tile		Post-medieval brick	
	Qty	Wt	Qty	Wt	Qty	Wt	Qty	Wt	Qty	Wt	Qty	Wt
T5	11	565			11	163			8	214		
T6	1	63										
T8									1	6		
T12	66	1,552	11	2,078	7	300	3	53	29	1,408	3	362
T13			1	110								
T14	1	334	1	292								
T17	13	1,197	2	115	4	745						
T19	13	1,841	3	598	6	711					1	72
T21	2	146	1	95	6	48			2	22		
T24	4	277	2	153	7	76			1	22	1	125
T28					1	123						
T49	1	64			1	164			3	287	6	1,187
T53	4	99			1	404			2	54		
T59	4	342							5	102		
T60	4	359			2	245	1	46				

Table 6 shows that the greatest weights of Roman building materials came from T12, T17 and T19. The latter two of these two trenches cut across the ditches of the Roman ?enclosure, and the building material is evidence of the former existence of a Roman structure in the vicinity. The absence of flue tile or box tile is interesting in that it suggests that the building did not have a hypocaust system.

Catalogue

T5

F33, Finds number 26

8 peg-tile fragments, 214g, D

1 Roman brick fragment (35mm thick), 163g, D

11 Roman tile fragments, 565g, D; 6 brick/tile scraps, 48g, D

1 medieval or post-medieval floor tile with traces of glaze, 42g

T6

F2, Finds number 1

1 Roman tile fragment, 63g, D

T8

F3, Finds number 2

1 peg-tile fragment 6g, D

1 brick/tile scrap, 3g, D

T12

F45, Finds number 32

1 Roman tile fragment, 137g, D
1 Roman *tegula* flange fragment, 324g

F46, Finds number 31

3 peg-tile fragments, 94g
5 Roman *imbrex* fragments, 220g, D
2 Roman brick fragments, 271g, D
4 Roman tile fragments, 167g, D
13 brick/tile scraps, 224g, D
1 septaria fragment, 14g, D

F46, Finds number 33

3 peg-tile fragments, 35g
2 Roman tile fragments, 117g, D
2 brick/tile scraps, 16g, D

F46, Finds number 35

1 slate fragment, 46g
3 post-medieval brick fragments (frogless), 632g, D
22 peg-tile fragments, 1246g, D
1 Roman *tegula* flange fragment, 93g
53 Roman tile fragments, 3548g, D
9 Roman brick fragments, 1807g, D
2 Roman *imbrex* fragments, 80g, D
2 ?*tesserae*, 28g
1 thin tile – ?peg-tile fragment, 12g
5 septaria fragments, 671g, D

F47, Finds number 34

1 thin tile – ?peg-tile fragment, 20g
5 brick/tile scraps, 21g
1 burnt Roman tile fragment, 131g
1 septaria fragment, 55g, D

F47, Finds number 37

3 Roman tile fragments, 229g
1 *tessera*, 25g
1 ?peg-tile fragment, 33g
6 brick/tile scraps, 49g

T13

F48, Finds number 28

1 Roman *imbrex* fragment, 110g, D

T14

F51, Finds number 29

1 Roman *imbrex* fragment, 292g, D
1 Roman tile fragment, 334g, D
1 septaria fragment, 7g, D

T17

F23, Finds number 18

1 large limestone lump, 3kg
2 greensand lumps, 228g
3 septaria lumps, 541g, D
4 Roman brick fragments, 745g, D
3 Roman tile fragments, 324g, D
2 Roman *tegula* flange fragments, 457g
1 Roman *imbrex* fragment, 36g, D
5 Roman tile scraps, 55g, D

F23, Finds number 20

3 Roman tile fragments, 361g, D
1 Roman *imbrex* fragment, 79g, D

1 brick/tile scrap, 2g
F23, Finds number 23
1 brick/tile scrap, 23g, D

T19

F7, Finds number 4
2 septaria lumps, 1,907g, D
2 Roman *imbrex* fragments, 352g, D

F7, Finds number 11
3 Roman brick fragments (40mm thick), 563g, D
4 Roman tile fragments, 225g, D
2 brick/tile scraps, 26g, D
1 Roman *imbrex* fragment, 246g, D
2 Roman *tegula* flange fragments, 641g
2 Roman buff tile fragments, 86
5 greensand lumps, 736g

F7, Finds number 39
1 Roman *tegula* flange fragment, 277g
1 Roman tile fragment, 575g, D
2 Roman brick fragments (37mm, 40mm thick), 123g, D
1 Roman brick/tile scrap, 25g

F9, Finds number 13
1 Roman tile fragment, 19g, D

F24, Finds number 19
1 slate fragment, 21g
1 post-Roman brick fragments, 72g

T21

F13, Finds number 6
2 peg-tile fragments, 22g, D

F14, Finds number 7
2 septaria lumps, 123g, D
1 Roman brick/tile scrap, 9g
1 peg-tile or thin Roman tile fragment, 6g

F16, Finds number 10
1 Roman *imbrex* fragment, 95g, D
2 Roman tile fragments, 146g, D
5 brick/tile scraps, 39g

T24

F25, Finds number 15
1 slate fragments, 18g
2 Roman *imbrex* fragments, 153g, D
4 Roman tile fragments, 277g, D
7 brick/tile scraps, 76g, D
1 ?post-Roman brick fragment, 125g
1 ?peg-tile fragment, 22g

T28

F65, Finds number 38
1 Roman brick fragment, 35mm thick, 123g, D

T49

F77, Finds number 42
1 Roman brick fragment, 164g, D
3 peg-tile fragments, 287g, D
1 Roman tile fragment, 64g, D
1 septaria fragment, 19g, D
6 Tudor-type brick fragments (47mm, 3 x 49mm thick), 1,187g

T53

F97, Finds number 45

2 peg-tile fragments, 54
1 Roman brick fragment, 404g (36mm thick), D
3 Roman tile fragments, 91g, D
1 limestone block, 617g

F106, Finds number 46
1 Roman tile fragment, 8g, D

T59

F122, Finds number 48
2 peg-tile fragments, 35g, D
1 Roman tile fragment, 19g, D

F122, Finds number 50
3 peg-tile fragments, 67g, D
3 Roman tile fragments, 323g, D

T60

F124, Finds number 49
1 *tessera*, 46g
1 Roman *tegula* flange fragment, 202g
3 Roman tile fragments, 157g, D
2 Roman brick fragments, 245g, D

Layers

L6, Finds number 3
7 peg-tile fragments, 183g, D
3 Roman *tegula* flange fragments, 1,485g
1 Roman buff tile fragment, 108g

L12, Finds number 30
5 small tile scraps; could be Roman or peg-tile, 45g

L13, Finds number 47
2 Roman tile fragments, 148g
1 peg-tile fragment, 34g

6.7 Catalogue of other finds

by H Brooks

This is a list of all finds not reported on separately above. (D = discarded.)

T5

F33, Finds number 26
1 animal bone, 20g, D
2 post-medieval green glass bottle fragments, 14g

T12

F45, Finds number 32
1 flint, 1g

T12

F46, Finds number 35
1 animal bone, 114g
1 ?schist fragment, 12g

T13

F48, Finds number 28
2 burnt flints, 95g

T17

F23, Finds number 18
3 animal bones, 4g

F23, Finds number 20
3 animal bones, 6g

T19

F7, Finds number 4
2 animal bones, 3g

F7, Finds number 39
1 animal bone, 123g

F24, Finds number 19
4 fragments of modern glass including milk bottle and window glass, 23g

T20

F18, Finds number 14
1 post-medieval green glass fragment, 2g

T21

F13, Finds number 6
1 modern milk bottle glass fragment, 6g, D

T21

F14, Finds number 7
1 animal bone, 3g

F14, Finds number 8
1 animal bone, 28g

T49

F77, Finds number 44
3 animal bones, 258g

F77, Finds number 42
6 animal bones, 101g, D

T53

F97, Finds number 45
2 animal bones, 38g, D

Note: this small quantity of animal bone (697g) will be included in the group for analysis after the excavation/mitigation stage (if appropriate).

7 Discussion

7.1 General conclusions

This evaluation has demonstrated that there has been extensive modern disturbance across the whole of Area L/N. This impact can be clearly seen firstly in the construction of the original Goojerat Barracks in 1900-1902 and subsequently in the areas of truncation in the south and west of the site and the high level of infill in the north and south-east corner associated with the rebuilding of Goojerat Barracks in 1971-75. All of the modern activity has impacted upon the underlying archaeological landscape. However, elements of that landscape do survive, in the central parts of the site, and these broadly fall into two main groupings, ie the Roman and the post-Roman landscapes.

7.2 Chronology

7.2.1 Prehistoric activity

None of the field ditches identified by this evaluation were of prehistoric date, and only a very few prehistoric finds were recovered, all residual in later contexts (ie Roman features). These comprised two burnt flints from Roman ditch F48 in T13, and a small prehistoric sherd and a small flint flake from Roman ditch F45 in T13. This small group of finds indicates some prehistoric activity, probably at a low level, at the eastern end of the valley running through what was to become the northern part of Goojerat Barracks.

7.2.2 Late Iron Age settlement

As has been pointed out by Stephen Benfield in his pottery report (see above, section 6.2), possibly the most interesting aspect of the pottery assemblage is the presence of a number of sherds typical of the Late Iron Age (such as are found at the Sheepen site on the banks of the River Colne, where they are dated to c 5 BC-AD 60: Niblett 1985, 3; Hawkes & Hull 1947). The distribution of these sherds is strongly biased in favour of the eastern side of Area L/N, specifically T9 (3 sherds), T13a (2 sherds), T19 (13 sherds) and T21 (1 sherd).

Although this is a small group of material, the general paucity of finds from Area L/N allows the speculation that there was some Late Iron Age activity of an undefined nature on the east side of Area L/N. Further, this material is concentrated mainly in the area of the later Roman ?enclosure, as defined by the Roman ditches intercepted by T19, T14 and T17. The pottery evidence would seem therefore to indicate an Late Iron Age origin for this ?enclosure. If this were so, then the site would parallel the Kirkee McMunn Barracks site (1km to the south), which is also a Roman site with Late Iron Age origins. Whether the Roman ditches in Area L/N were recuts of Late Iron Age ditches is more difficult to prove, but this must remain a possibility.

7.2.3 Roman landscape

Fragments of a rectilinear Roman agricultural landscape have survived in the centre and on the eastern side of Area L/N. This landscape was defined by nine fragments of field ditch which share a common alignment of south-west to north-east and north-west to south-east. The Roman date of these ditches is given by both pottery and tile recovered from their middle to lower fills, although there is a possibility (see above, section 7.2.2) that some elements of the field system are of Late Iron Age origin, and were recut in the Roman period.

A focus of Roman activity has been identified in the south-east quarter of Area L/N, where the configuration of ditches intercepted by (clockwise) T19, T14, and T17 hints at three sides of an ?enclosure, the fourth side of which (if it existed) may have lain beyond the eastern edge of Area L/N and perhaps close to the line of Circular Road South.

A large volume of Roman building material was recovered from the ditches of this ?enclosure, ie from F23 in T17 and from F7 in T19. This material included not only Roman bricks and roof tiles, but also a shaped piece of limestone which was probably architectural, ie a lintel, or a threshold or window embrasure. This must indicate that the site of a Roman building exists nearby. The mechanism by which the Roman building debris was transferred into the ditches of the ?enclosure is not clear, but it may have happened when the building was dismantled, and the fact that the debris was dumped into open ditches demonstrates a demolition date in or shortly after the Roman period. Most of the debris came from T17, which may indicate that the Roman building was in the northern part of the ?enclosure (although the greensand came from T19 in the southern half of the ?enclosure). A fragment of Mayen lava from a quern, found in T17, may be seen as either a domestic fragment used in flour production or as an agricultural item. Either way, crops would appear to have been grown in the vicinity.

The two trenches which cut across the central part of this ?enclosure did not reveal evidence of any other any structures, wooden or otherwise. There were, however, groups of post-holes and isolated post-holes at various points across Area L/N. Collectively, these were probably parts of fence lines used for stock control, but some post-holes may have been parts of fences along one side of the ditches (of the ?enclosure and elsewhere).

A simple Roman 'villa-type' residence has been identified via its hypocaust pit at Kirkee McMunn Barracks (approximately 1km to the south of this site), and a similar small-scale area of Roman occupation has recently been identified in GAL Area E (approximately 500m to the north-east). It remains to be seen how the probable farmstead at/adjacent to Area L/N fits into this Roman farmed and inhabited landscape.

There were seven Roman or undated and possibly Roman pits. Given that the severity of the truncation of Area L/N may have seriously affected the survival of pits

and other archaeological features, it is noticeable that these pits are clustered on the east edge of Area L/N and close to the ?enclosure, and also on the west edge of Area L/N. However, the pits on the western side of Area L/N only contained (collectively) a single piece of Roman tile, so an agricultural rather than a domestic function may be suggested.

A small axial valley, infilled with colluvium that largely post-dates the Roman ditch (in T12), was located extending east-west to the north of the Roman ?enclosure. This valley must have linked with the wider main valley, the course of which is on the line of Circular Road South, and is probably reflected by the modern levelling deposits in the south-eastern part of Area L/N. If so, then the Roman ?enclosure appears to have been situated on a plateau at the junction of the two valleys (Fig 2).

7.2.4 Anglo-Saxon and medieval

No finds or features of these periods were recorded.

7.2.5 Post-medieval landscape and Goojerat Barracks

Like the Roman landscape, the post-Roman landscape is highly fragmented in its survival. Three main ditches have been identified; these were aligned across and obliquely to the Roman field system, on an east-west alignment. This field system may have had its origins in the medieval period, although material recovered was exclusively post-medieval. In addition to an agricultural landscape, there have also been episodes of post-medieval quarrying activity. This activity is most noticeable on the eastern side of the site in T24 and T7.

However, the overriding legacy of the post-medieval and modern periods is that of Goojerat Barracks itself. Structural and infrastructural elements have been identified across the site. Many of these buildings can be related to the 1900-1902 barracks buildings shown on the RE 1949 plan. Evidence for later activities still dates from when Goojerat Barracks was demolished in 1970-71 and rebuilt in 1971-75, with areas of massive infilling and truncation in the north and south of the camp, allowing for the landscaping and construction of the current establishment.

8 Acknowledgements

CAT and RPS Planning would like to thank Taylor Wimpey (especially Robert Taylor and John Phillips) for commissioning and funding the work, and Bovis Homes (Tony Lee) for their help with the project.

The project was managed by B Holloway, and the site work was carried out by L Driver, M Górnjak, B Hurrell, C Lister, N Rayner and D Ross, with digital survey carried out by C Lister assisted by B Holloway.

The project was monitored for Colchester Borough Council by Martin Winter, and for RPS Planning by Robert Masefield.

9 References

- | | | |
|----------------|------|--|
| CAR 1 | 1981 | <i>Colchester Archaeological Report 1: Aspects of Anglo-Saxon and Norman Colchester</i> , CBA, Research Report, 39 , by P Crummy |
| CAR 5 | 1988 | <i>Colchester Archaeological Report 5: The post-Roman small finds from excavations in Colchester 1971-85</i> , by N Crummy |
| CAR 7 | 2000 | <i>Colchester Archaeological Report 7: Post-Roman pottery from excavations in Colchester, 1971-1985</i> , by J Cotter |
| CAR 10 | 1999 | <i>Colchester Archaeological Report 10: Roman pottery from excavations in Colchester, 1971-86</i> , by R P Symonds and S Wade, ed by P Bidwell and A Croom |
| CAT | 1998 | <i>Siege map of Colchester</i> |
| CAT | 1999 | <i>Policies and procedures</i> |
| CAT Report 206 | | An archaeological evaluation by trial-trenching in Areas A, B, D, GJ, H, J, N, V and YP of the Colchester Garrison PFI site Colchester, Essex, June-July 2002, unpublished CAT archive report, by H Brooks, 2002 |

CAT Report 207		An archaeological evaluation by trial-trenching on Areas DR, G, M, P, Q, R, RO, S and T at Colchester Garrison PFI site, Colchester, Essex, May-September 2002, unpublished CAT archive report, by H Brooks, 2002
CAT Report 292 (in association with RPS)		The Colchester Garrison PFI project, Colchester, Essex: a report on the 2003 excavation of Areas 2, 6, 10, August-November 2003, unpublished CAT archive report, by H Brooks and R Masefield, 2005
CAT Report 361		Assessment report on the archaeological investigations carried out on Areas C1, C2, E, J1, O, Q and S1 of the Alienated Land, Colchester Garrison, including the Time Team trenches and the Alienated Land watching brief, 2004-2005, unpublished CAT archive report, by L Pooley, B Holloway, P Crummy and R Masefield, 2006
CAT Report 405		Stage 1b archaeological evaluation, Alienated Land Area B1a, Colchester Garrison, Colchester, Essex, January 2007, unpublished CAT archive report, by L Pooley, H Brooks and B Holloway, 2007
CAT Report 412	forth-coming	Report on the archaeological investigations carried out on Areas C1, C2, E, J1, O, Q and S1 of the Alienated Land, Colchester Garrison, including the Time Team trenches and the Alienated Land watching brief, May 2005-January 2006, CAT archive report, by L Pooley, B Holloway, P Crummy and R Masefield
CAT Report 428 (in association with RPS)		Interim assessment report on Stage 2 archaeological excavations, Alienated Land Area S2 (south), Colchester Garrison, Colchester, Essex, February-March 2007, unpublished CAT archive report, by H Brooks, B Holloway and R Masefield, 2007
CAT Report 438 (in association with RPS)		Stage 1b archaeological evaluation, Alienated Land Area B1b, Colchester Garrison, Colchester, Essex, July-September 2007, unpublished CAT archive report, by H Brooks, B Holloway and R Masefield, 2008
CAT Report 97		An archaeological desk-based assessment of the Colchester Garrison PFI site, unpublished CAT archive report, by K Orr, 2000
Chapman & André	1777	map of the County of Essex
CM	2002	<i>Guidelines on standards and practices for archaeological fieldwork in the Borough of Colchester</i>
CM	2003	<i>Guidelines on the preparation and transfer of archaeological archives to Colchester Museums</i>
Cole & Roper	c 1800-1815	map of Colchester
Crummy, N	2003	'The small finds', 141-2, in 'Excavations at St Mary Magdalen's hospital, Brook Street, Colchester', by C Crossan, in <i>Essex Archaeology and History</i> , 34 , 91-154
Crummy, P, Benfield, S, Crummy, N, Rigby, V, & Shimmin, D	2007	<i>Stanway: an élite burial site at Camulodunum</i> , Britannia, Monograph Series, 24
Davies, B, J, Richardson, B, & Tomber, R S	1994	<i>The archaeology of London 5. A dated corpus of early Roman pottery from the City of London</i> , CBA, Research Report, 98
EAA 14	2003	<i>Standards for field archaeology in the East of England</i> , East Anglian Archaeology, Occasional Papers, 14 , ed by D Gurney
EAA 3	1997	<i>Research and archaeology: a framework for the Eastern Counties 1. Resource assessment</i> , East Anglian Archaeology, Occasional Papers, 3 , ed by J Glazebrook
EAA 8	2000	<i>Research and archaeology: a framework for the Eastern Counties 2. Research agenda and strategy</i> , East Anglian Archaeology, Occasional Papers, 8 , ed by N Brown and J Glazebrook
French	1650	map of Colchester

Gilberd	1846	map of Colchester
Hawkes, C F C, & Hull, M R	1947	<i>Camulodunum, first report on the excavations at Colchester 1930-39</i> , RRCSAL, 14
Hull, M R	1958	<i>Roman Colchester</i> , RRCSAL, 20
IFA	1999	<i>Standard and guidance for archaeological field evaluation</i>
IFA	2001	<i>Standard and guidance for the collection, documentation, conservation and research of archaeological materials</i>
Lavender, N	2007	'Prehistoric pottery', in <i>Neolithic and Bronze Age monuments and Middle Iron Age settlement at Lodge Farm, St Osyth, Essex</i> , by M Germany, East Anglian Archaeology, 177 , 62-77
Manning, W H	1985	<i>Catalogue of the Romano-British iron tools, fittings and weapons in the British Museum</i>
MAP 2	1991	<i>Management of archaeological projects</i> , second edition (English Heritage)
Niblett, R	1985	<i>Sheepen, an early Roman industrial site at Camulodunum</i> , CBA, Research Report, 57
OS		Ordnance Survey: various maps, ie 1874-76, 1921
RE	1949	Royal Engineers' 1949 plan of Colchester Garrison, copy held in CAT archives
RPS	2002	<i>Colchester Garrison Alienated Land outline archaeological project strategy proposal and quality plan</i>
RPS	2004	<i>Research design for archaeological evaluations, excavations and watching briefs on Alienated Land, new garrison, Colchester</i>
RPS in association with CAT	2007	<i>Written Scheme of Investigation (WSI) for Stage 1b archaeological trial-trenching evaluation, Area L/N, Colchester Garrison, Colchester</i>
Sealey, P R	2007	<i>A Late Iron Age warrior burial from Kelvedon, Essex</i> , East Anglian Archaeology, 118
Sealey, P R	forth-coming	'The prehistoric pottery', in Report on the Archaeological investigations carried out on Areas C1, C2, E, J1, O, Q and S1 of the Alienated Land, Colchester Garrison, including the Time Team Trenches and the Alienated Land watching brief, by L Pooley, B Holloway, P Crummy and R Masefield, CAT Report 412 (forthcoming)
Shimmin, D	1998	'A Late Iron Age and Roman occupation site at Kirkee McMunn barracks, Colchester, Essex', in <i>Essex Archaeology and History</i> , 29 , 260-69
Speed, John	1610	map of Colchester
Tomber, R, & Dore, J	1998	<i>The National Roman Fabric Reference Collection, a handbook</i> , MoLAS, Monograph, 2
Tyers, P	1996	<i>Roman pottery in Britain</i> (reprinted 1999)
Webster, P	1996	<i>Roman samian pottery in Britain</i> , CBA, Practical handbook in archaeology, 13

10 Abbreviations and glossary

Anglo-Saxon	post-Roman, AD 410 to c AD 1066
AOD	Above Ordnance Datum
Bronze Age	2,500 BC to c 700 BC
CAT	Colchester Archaeological Trust
CBC	Colchester Borough Council
CM	Colchester and Ipswich Museums
context	specific location on an archaeological site, especially one where finds are made
EH	English Heritage
EOD	explosive ordnance disposal
feature	an identifiable thing like a pit, or ditch; can contain contexts
IFA	Institute of Field Archaeologists
Late Iron Age	c 200 BC-AD 43
medieval	c AD 1066 to c AD 1500
modern	c 1800 to the present day

natural	natural deposit undisturbed by human activity
Neolithic	New Stone Age, c 4,000 BC to c 2,500 BC
NGR	National Grid Reference
post-medieval	c AD 1500 to AD 1800
prehistoric	belonging to the Stone, Bronze or Iron Ages (ie pre-Roman)
residual	an early find in a late context (eg a Roman coin in a 19th-century pit)
Roman	the period from AD 43 to around AD 430
RPS	RPS Planning (project consultants)
UAD	Urban Archaeological Database, held and maintained by CM

11 Archive deposition

The paper and digital archive is currently held by the Colchester Archaeological Trust at 12 Lexden Road, Colchester, Essex CO3 3NF, but it will be permanently deposited with Colchester and Ipswich Museums, under accession code COLEM 2006.127.

12 Context list

Context	Trench	Description	Date
F1	T3	pit	modern
F2	T8	pit	post-medieval
F3	T8	pit	post-medieval
F4	T8	pit	undated
F5	T7	quarry-pit	post-medieval
F6	T10	natural pit or tree-throw pit	undated
F7	T19	ditch, W boundary of Roman ?enclosure	Roman
F8	T19	pit	modern
F9	T19	pit	Roman
F10	T19	wall foundation	modern
F11	T19	military rubbish-pit	modern
F12	T19	military rubbish-pit	modern
F13	T21	gully	post-medieval
F14	T21	ditch	Roman
F15	T21	post-hole	post-medieval
F16	T21	pit	Roman
F17	T19	service run	modern
F18	T20	ditch	post-medieval
F19	T20	natural pit or tree-throw pit	undated
F20	T20	post-hole	Roman
F21	T20	natural pit or tree-throw pit	undated
F22	T20	post-hole	undated (?Roman)
F23	T17	ditch	Roman
F24	T19	pit	modern
F25	T24	quarry-pit	post-medieval
F26	T25	road/footpath	modern
F27	T29	pit	modern
F28	T29	brick-lined drain	modern
F29	T31	wall foundation	modern
F30	T31	wall foundation	modern
F31	T31	natural pit or tree-throw pit	undated
F32	T34	wall foundation	modern
F33	T5	military rubbish-pit	modern
F34-F44	T17	post-hole (associated with ditch F23)	undated (?Roman)
F45	T12	ditch	Roman
F46	T12	ditch, associated with Civil War siegeworks?	post-medieval
F47	T12	erosion hollow associated with F46?	post-medieval

Context	Trench	Description	Date
F48	T13	ditch, continuation of F45?	Roman
F49	T13	natural linear feature	undated
F50	T14	wall foundation	modern
F51	T14	ditch, north boundary of Roman ?enclosure	Roman
F52	T16	natural feature	undated
F53- F56	T35	post-hole	undated (?Roman)
F57	T27	wall foundation	modern
F58	T13	post-hole (northern edge of F48); possible fence line?	undated (?Roman)
F59	T13	post-hole (in group F59-F60, F63); ?structural element	undated (?Roman)
F60	T13	post-hole (in group F59-F60, F63)	undated (?Roman)
F61	T13	wall foundation	modern
F62	T13	wall foundation	modern
F63	T13	post-hole (in group F59-F60, F63); ?structural element	undated (?Roman)
F64	T35	post-hole (group F53-F56 inc F64); possibly structural	undated (?Roman)
F65	T28	ditch	Roman
F66- F67	T37	wall foundation	modern
F68	T41	wall foundation	modern
F69	T42	pit	modern
F70	T42	wall foundation	modern
F71	T42	natural pit or tree-throw pit	undated
F72	T44	pit	modern
F73- F74	T46	wall foundation	modern
F75	T45	natural pit or tree-throw pit	undated
F76	T45	natural pit or tree-throw pit	undated
F77	T49	ditch	post-medieval
F78	T49	wall foundation	modern
F79	T49	pit	Roman
F80	T49	post-hole	undated (?Roman)
F81	T49	pit	undated (?Roman)
F82	T49	ditch	undated (?Roman)
F83	T49	ditch	undated
F84	T49	natural pit or tree-throw pit	undated
F85	T49	natural pit or tree-throw pit	undated
F86	T52	military rubbish-pit	modern
F87	T52	service run	modern
F88- F89	T52	service run	modern
F90- F91	T51	natural pit or tree-throw pit	undated
F92	T51	pit	Roman
F93	T51	post-hole	undated (?Roman)
F94- F95	T53	wall foundation	modern
F96	T53	natural pit or tree-throw pit	undated
F97	T53	ditch	late medieval or later
F98	T53	wall foundation	modern
F99	T53	natural pit or tree-throw pit	undated
F100	T53	wall foundation	modern
F101	T50	pit	Roman
F102	T50	natural pit	undated
F103	T50	post-hole	undated (?Roman)
F104- F105	T50	natural pit	undated
F106	T53	pit	Roman
F107	T61	ditch	undated (?Roman)
F108	T61	removed foundation	modern

Context	Trench	Description	Date
F109	T61	post-hole	undated (?Roman)
F110	T61	ditch terminal?	undated (?Roman)
F111	T62	natural pit or tree-throw pit	undated
F112- F113	T60	natural pit or tree-throw pit	undated
F114	T62	natural pit or tree-throw pit	undated
F115	T62	removed foundation	modern
F116	T62	wall foundation	modern
F117- F118	T62	natural pit or tree-throw pit	undated
F119	T62	ditch	undated (?Roman)
F120- F121	T57	natural pit or tree-throw pit	undated
F122	T59	ditch, continuation of F46	post-medieval
F123	T59	wall foundation	modern
F124	T60	ditch, ?continuation of F122/F46	post-medieval
L1	all trenches in grassed areas	turf/topsoil	
L2	all	dumped soil with concrete/brick bits	modern
L3	all	dumped sand make-up	modern
L4	all	original pre-Garrison topsoil	post-medieval
L5	all	natural sand-and-gravel	-
L6	all	pre-Garrison lower topsoil	post-medieval
L7	T4-T6	tarmac and hard-standing	modern
L8	T5	original topsoil?	post-medieval
L9	T5	dumped soil	post- medieval/modern
L10	T5	redeposited natural	post- medieval/modern
L11	T4-T6	remnant lower topsoil?	post-medieval
L12	T11, T12	post-Roman topsoil	post-Roman
L13	T12, T13	colluvium or hill-wash	post-Roman
L14	T37-T41	dumped hardcore	modern

© Colchester Archaeological Trust 2008

Distribution list:

Taylor Wimpey
RPS Planning
Martin Winter, Colchester Borough Council
Essex Historic Environment Record, Essex County Council



Colchester Archaeological Trust

12 Lexden Road,
Colchester,
Essex CO3 3NF

tel.: (01206) 541051
(01206) 500124

email: archaeologists@catuk.org

Checked by: Philip Crummy
Date: 28.03.08

Philip c:/j 2008/reports 08/garrison Area L-N/final/report456finalx.doc

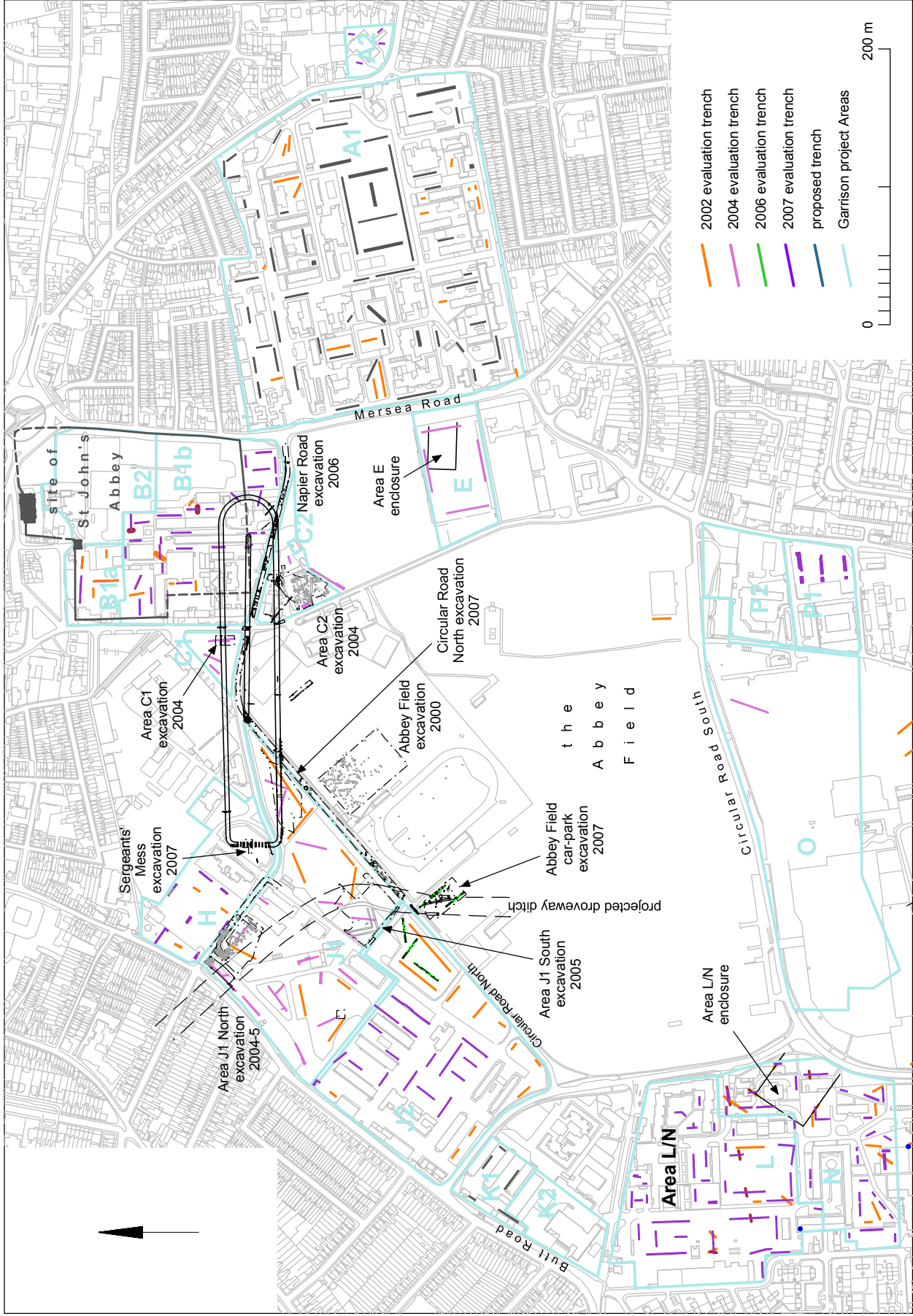

Fig 1 Site location.

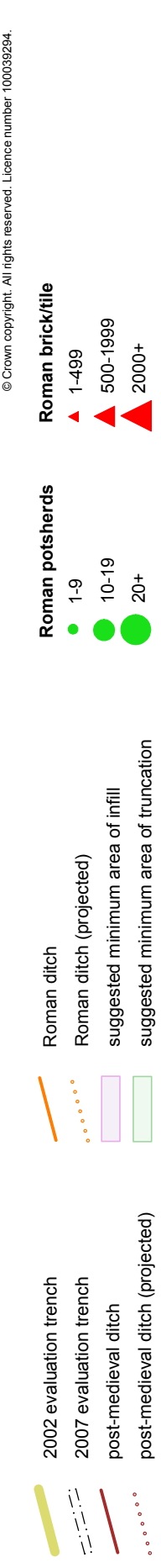
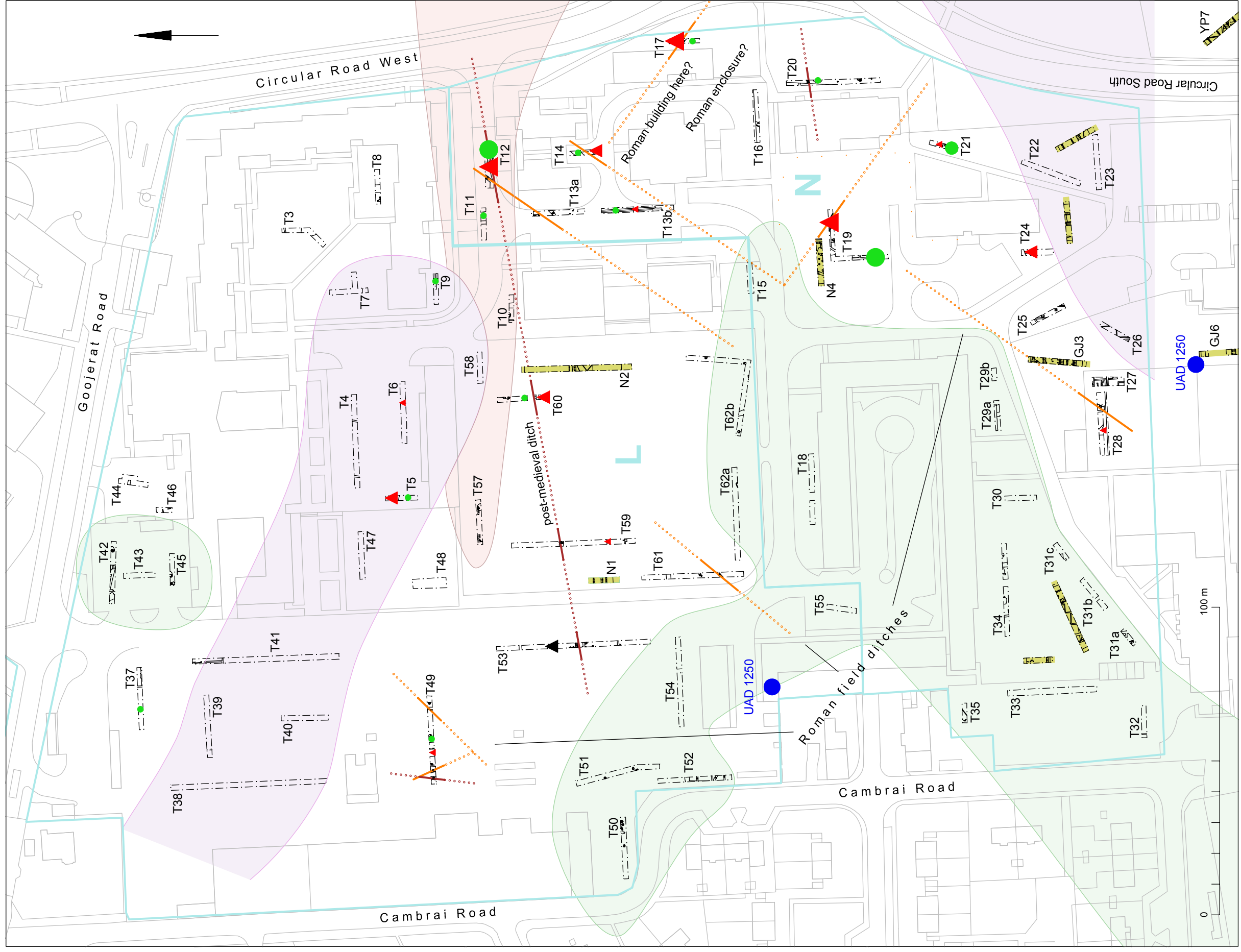

Fig 2 Plan of trenches.

© Crown copyright. All rights reserved. Licence number 100039294.

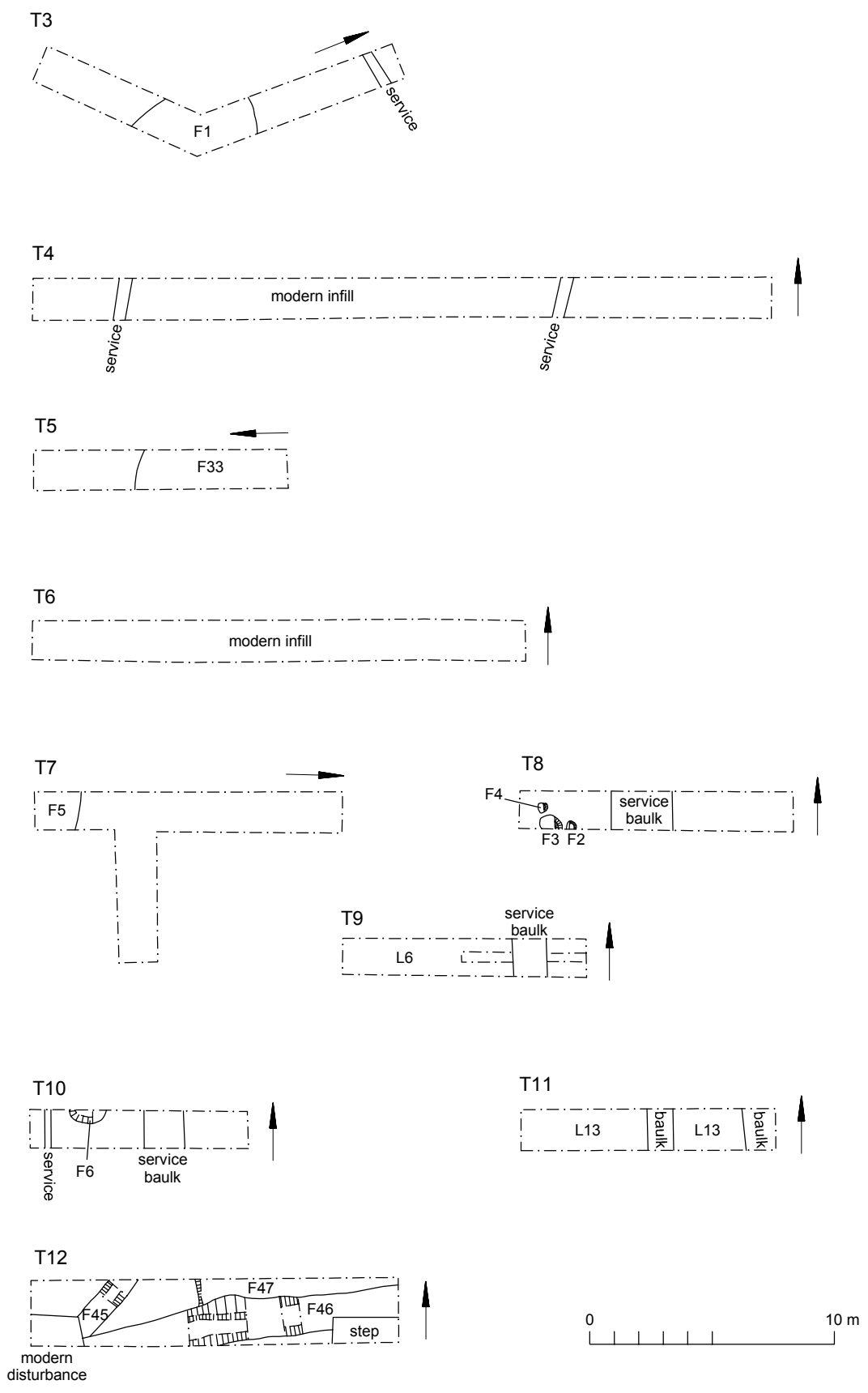

Fig 3 T3-T12: plans.

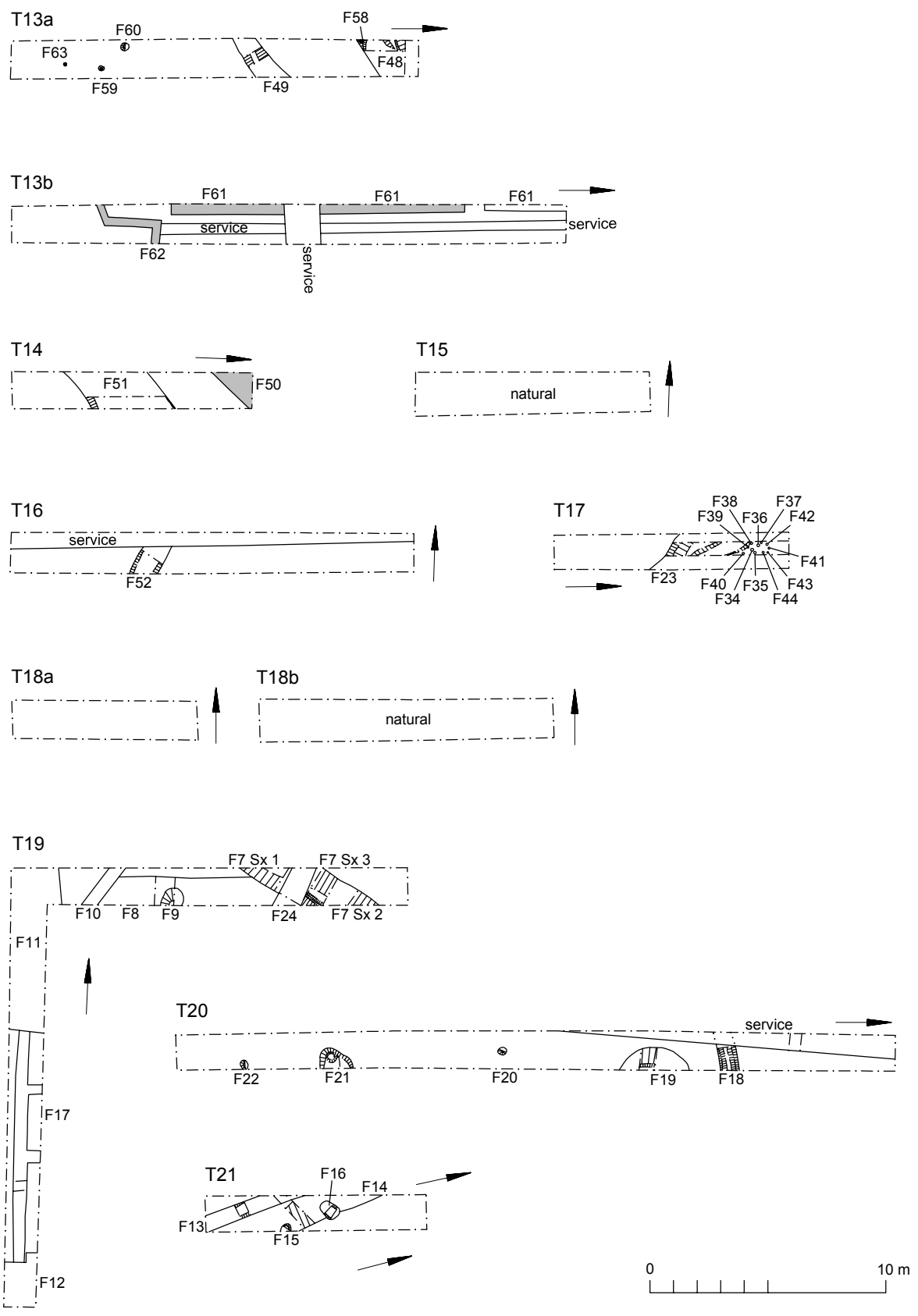

Fig 4 T13-T21: plans.

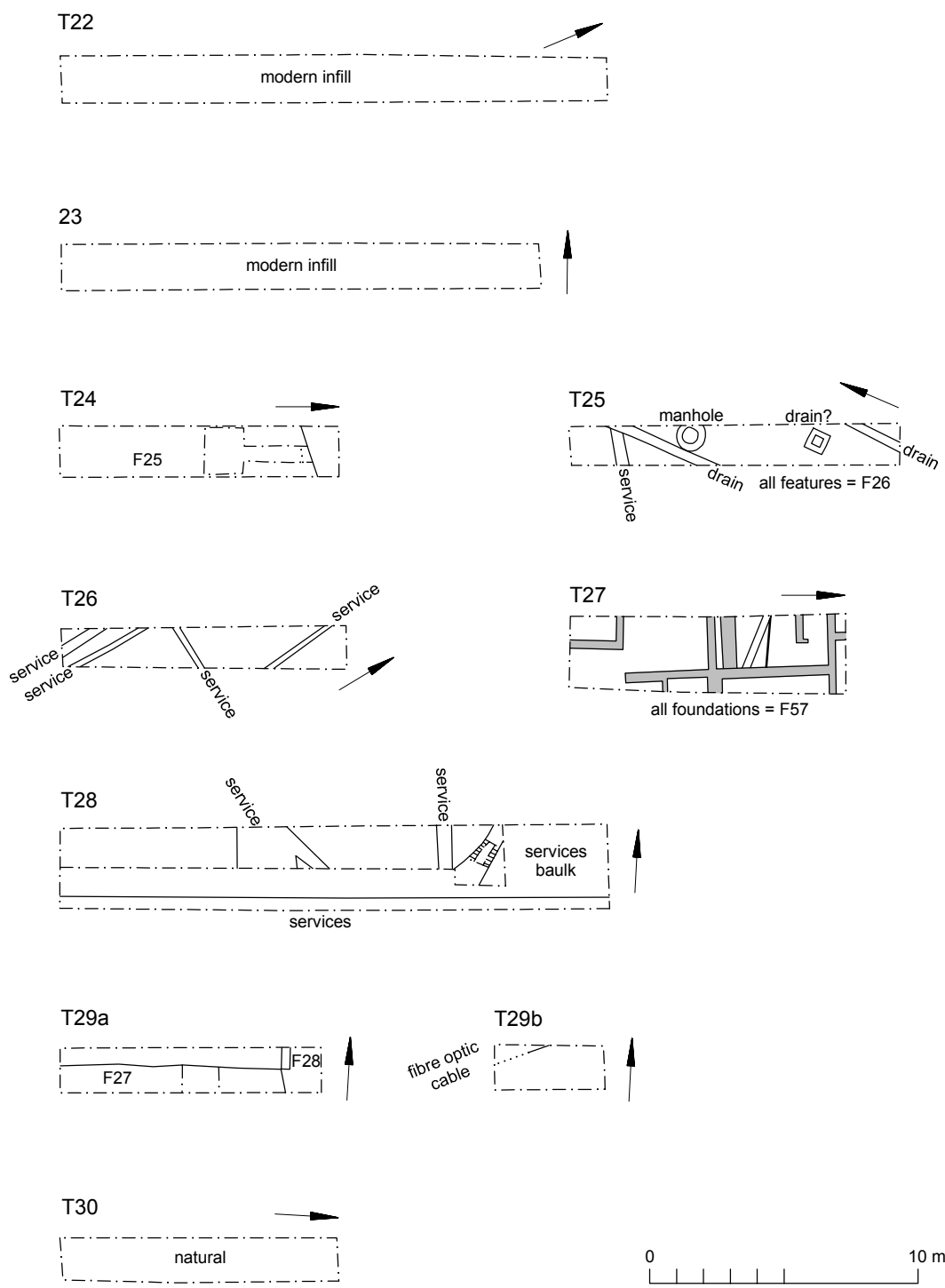

Fig 5 T22-T30: plans.

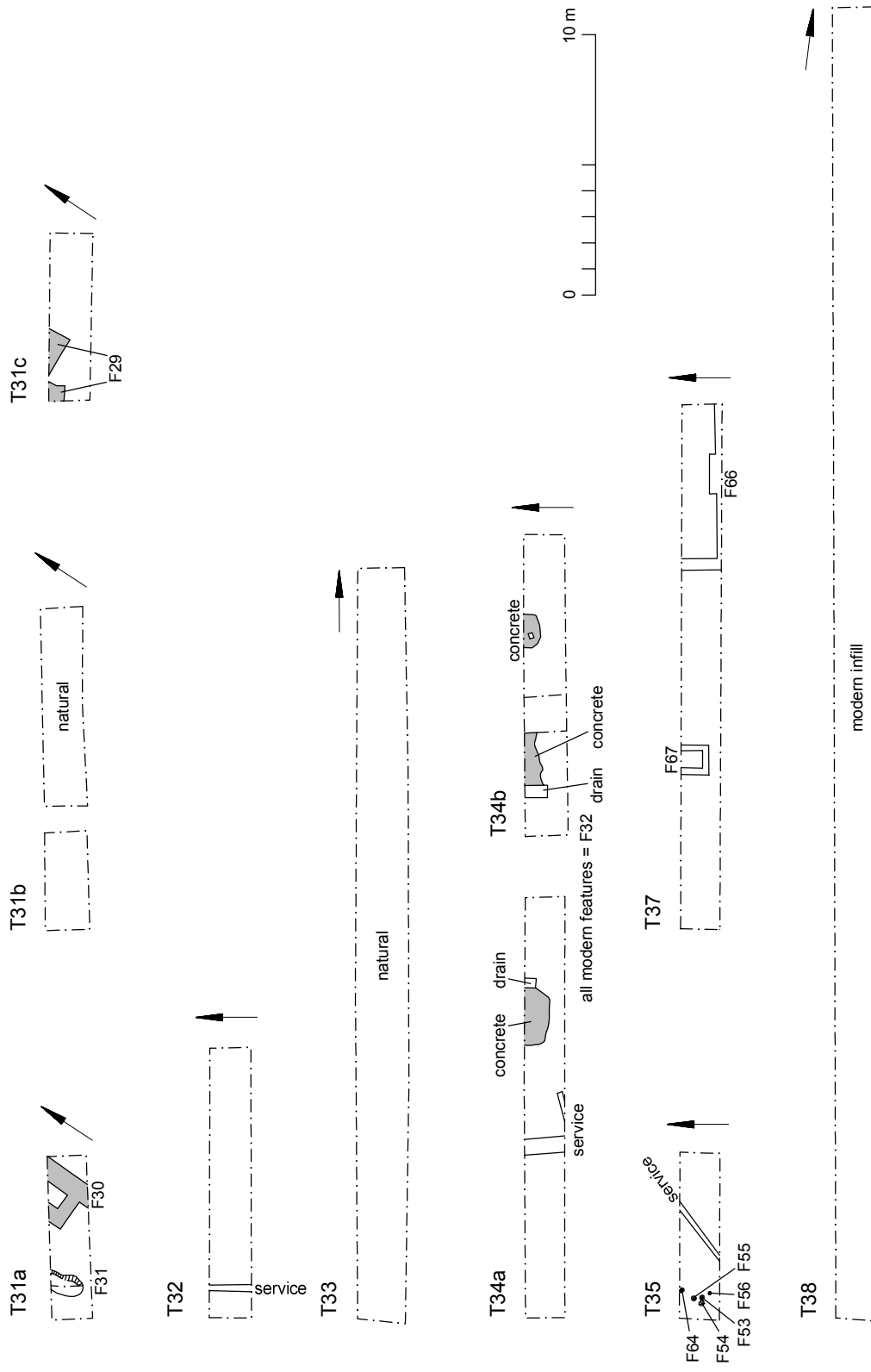

Fig 6 T31-T35 and T37-T38: plans.

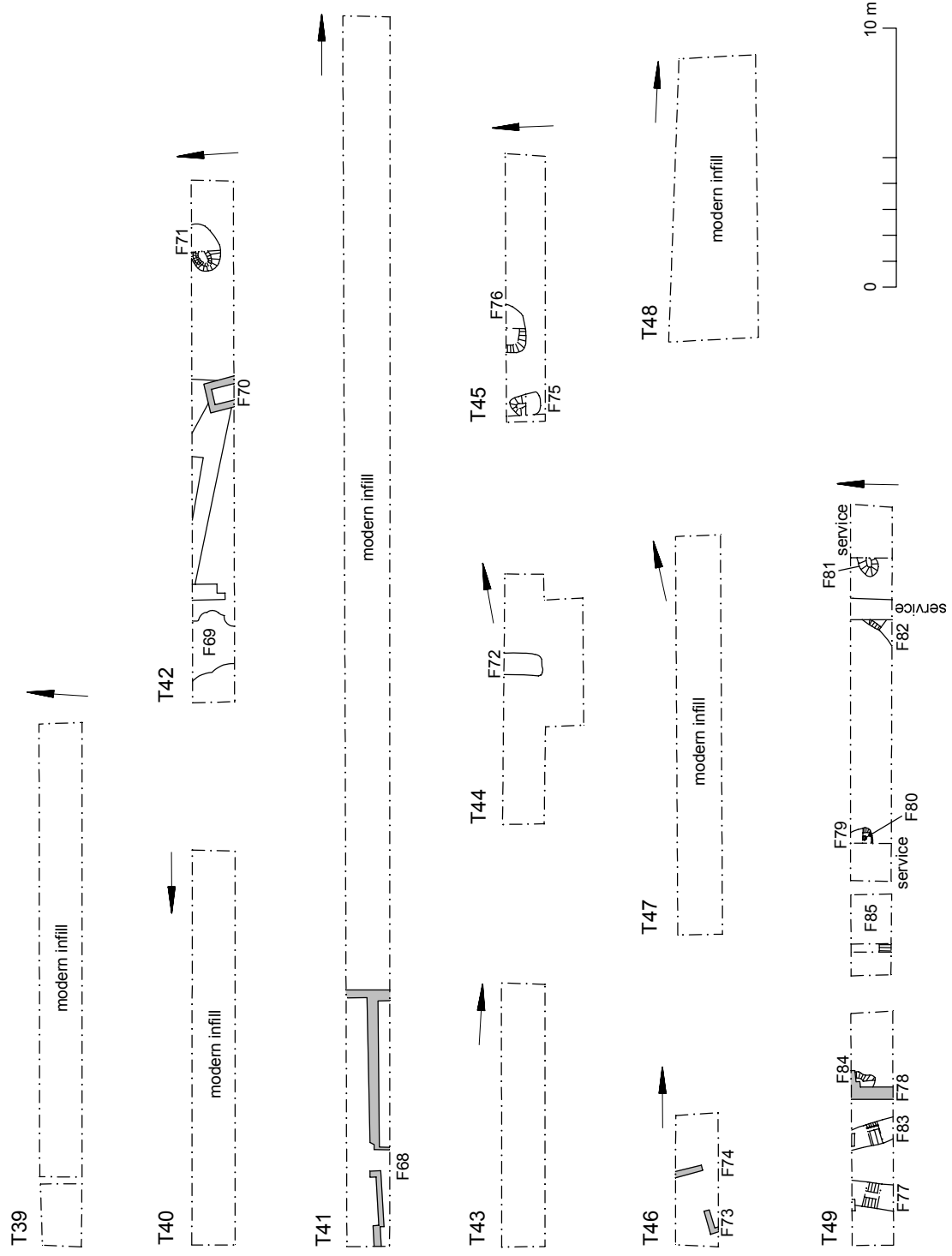

Fig 7 T39-T49: plans.

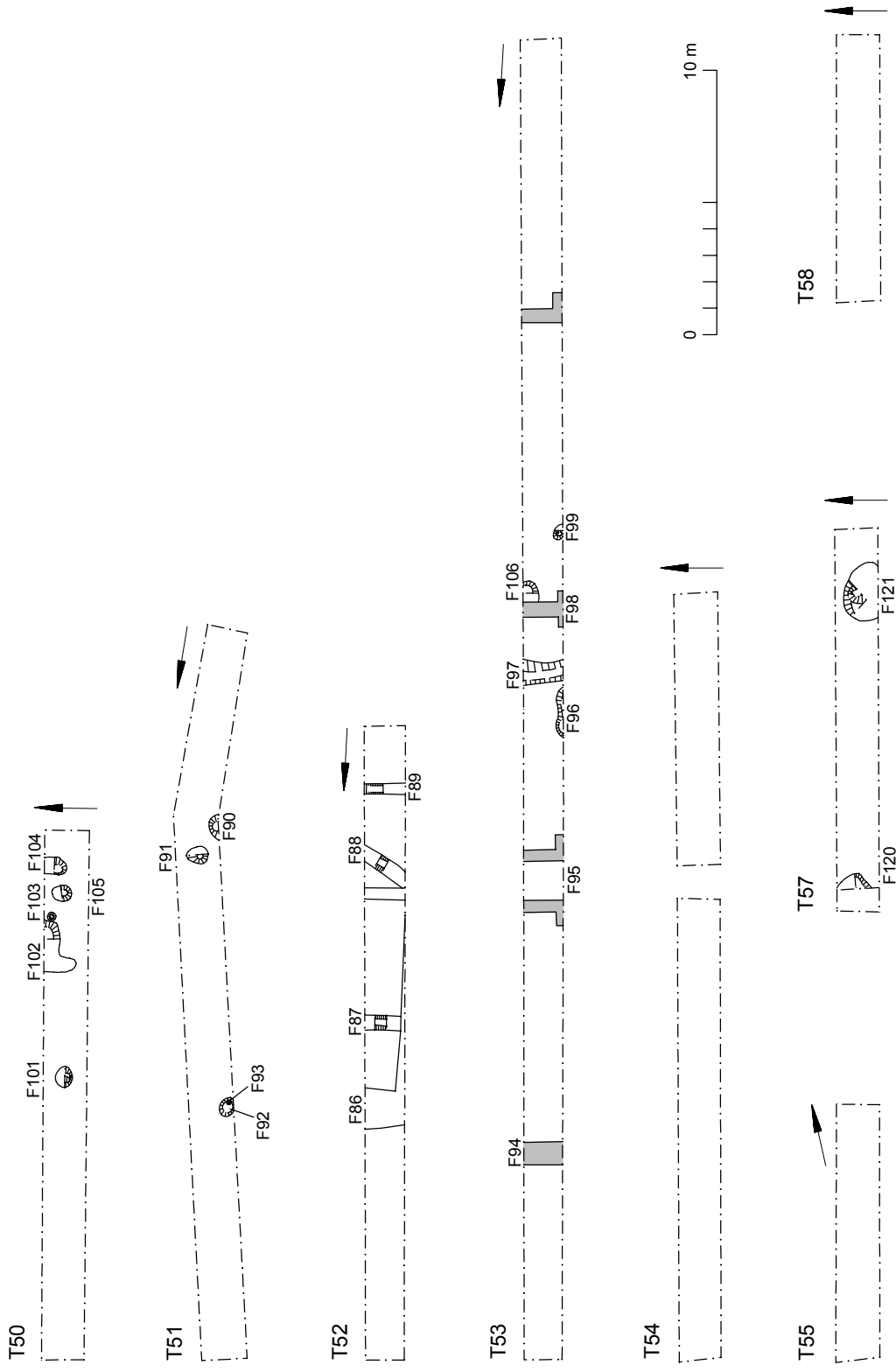

Fig 8 T50-T55 and T57-T58: plans.

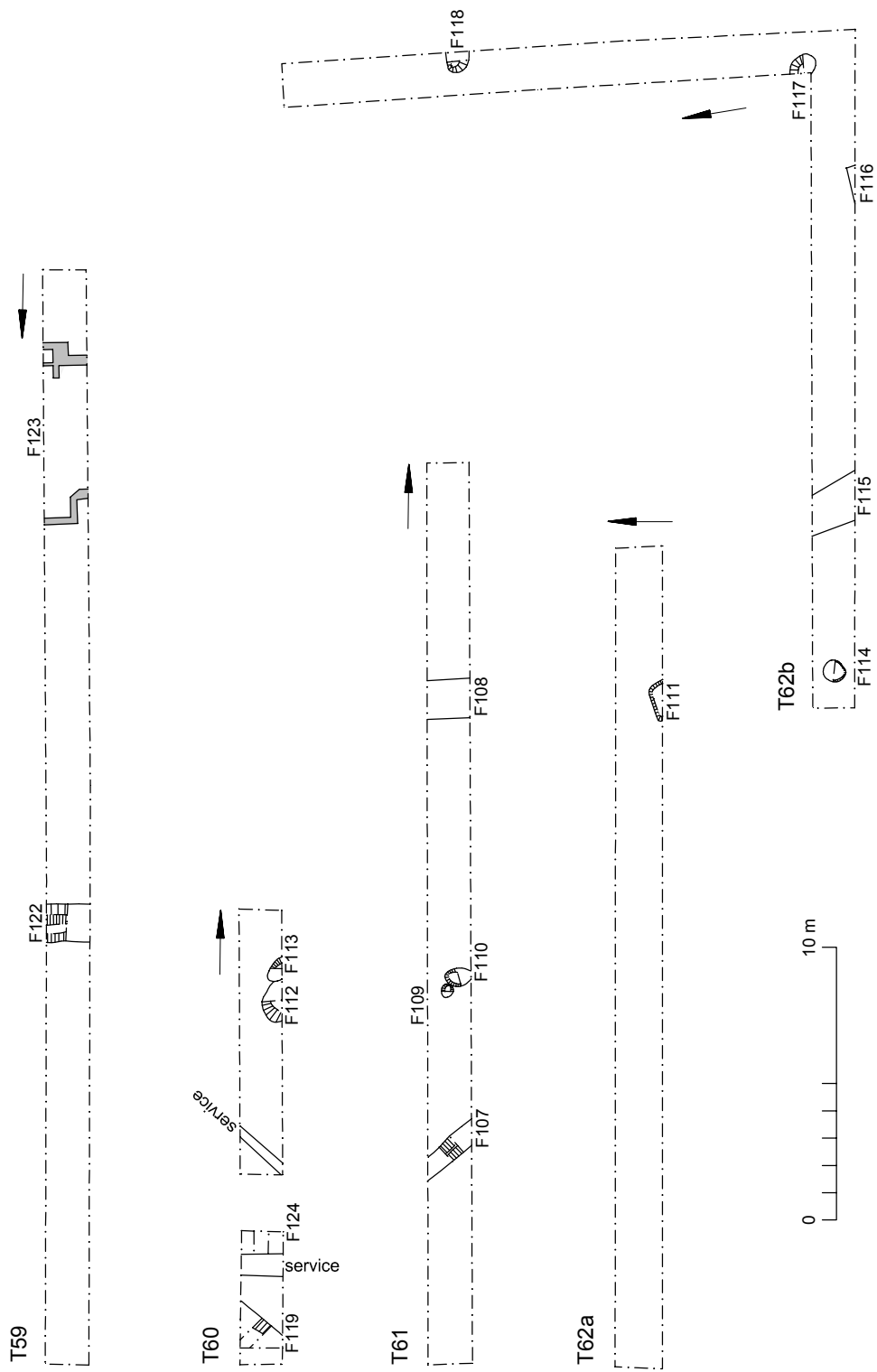

Fig 9 T59-T62: plans.

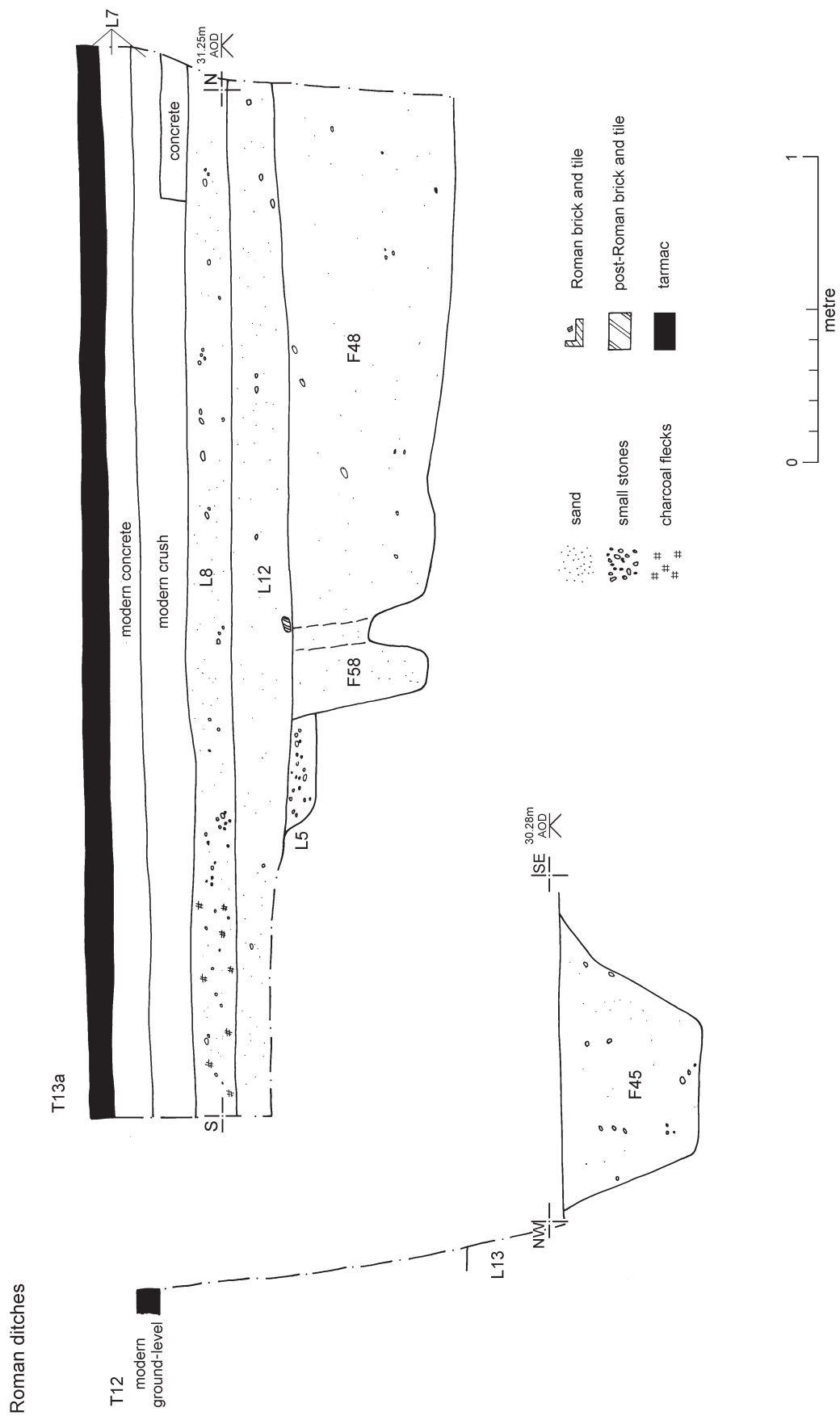

Fig 10 T12, T13: Roman ditch sections.

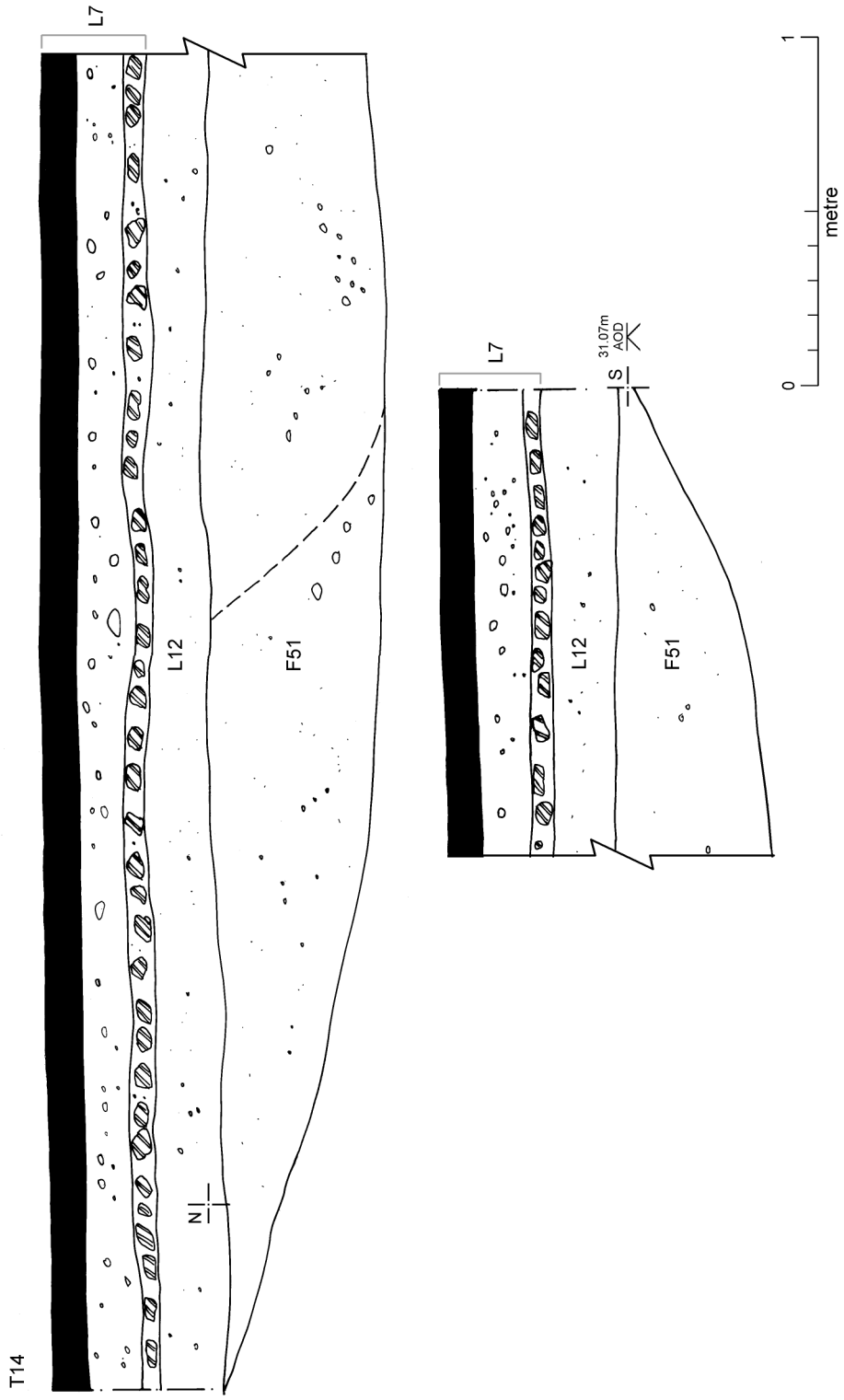

Fig 11 T14: Roman ditch section.

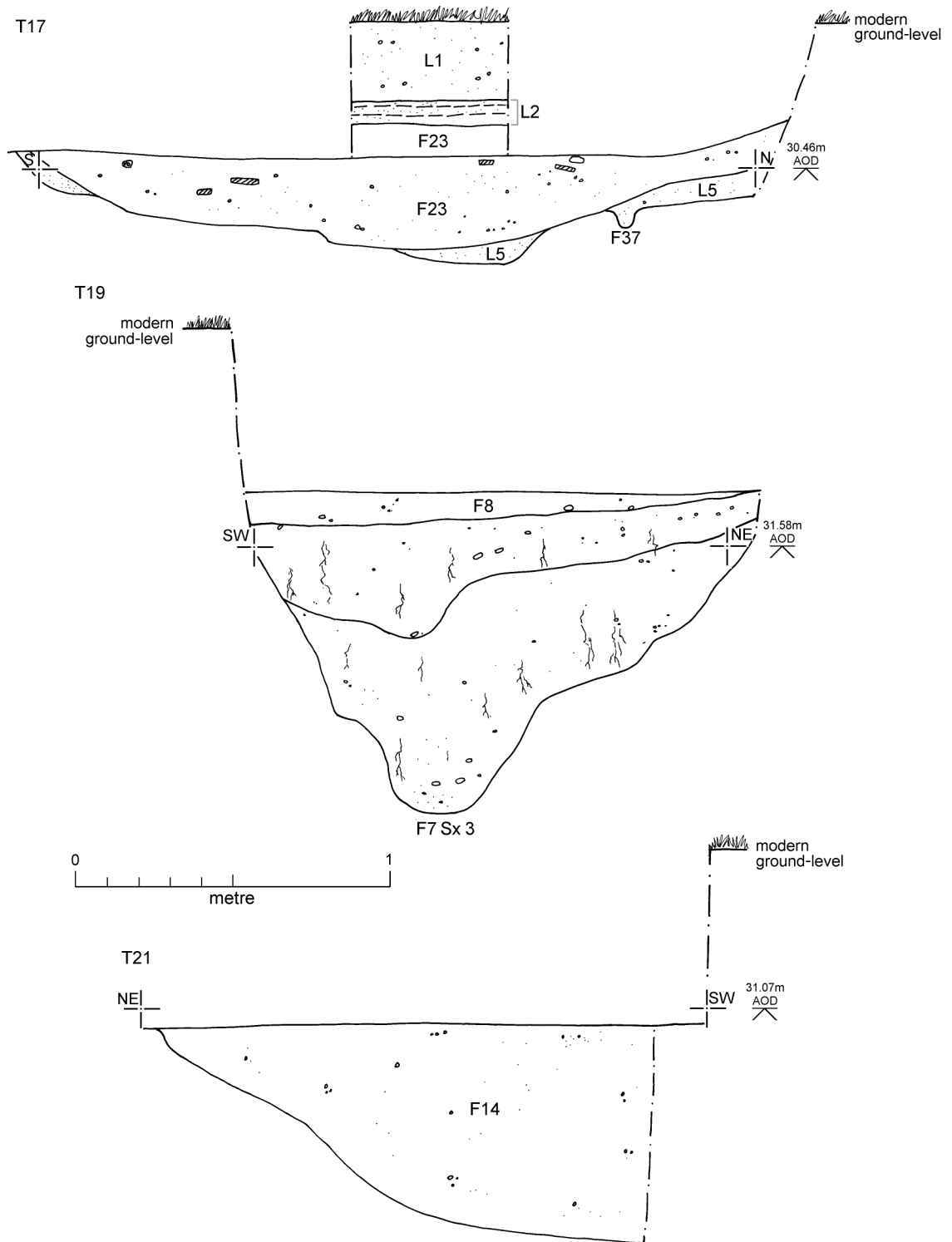
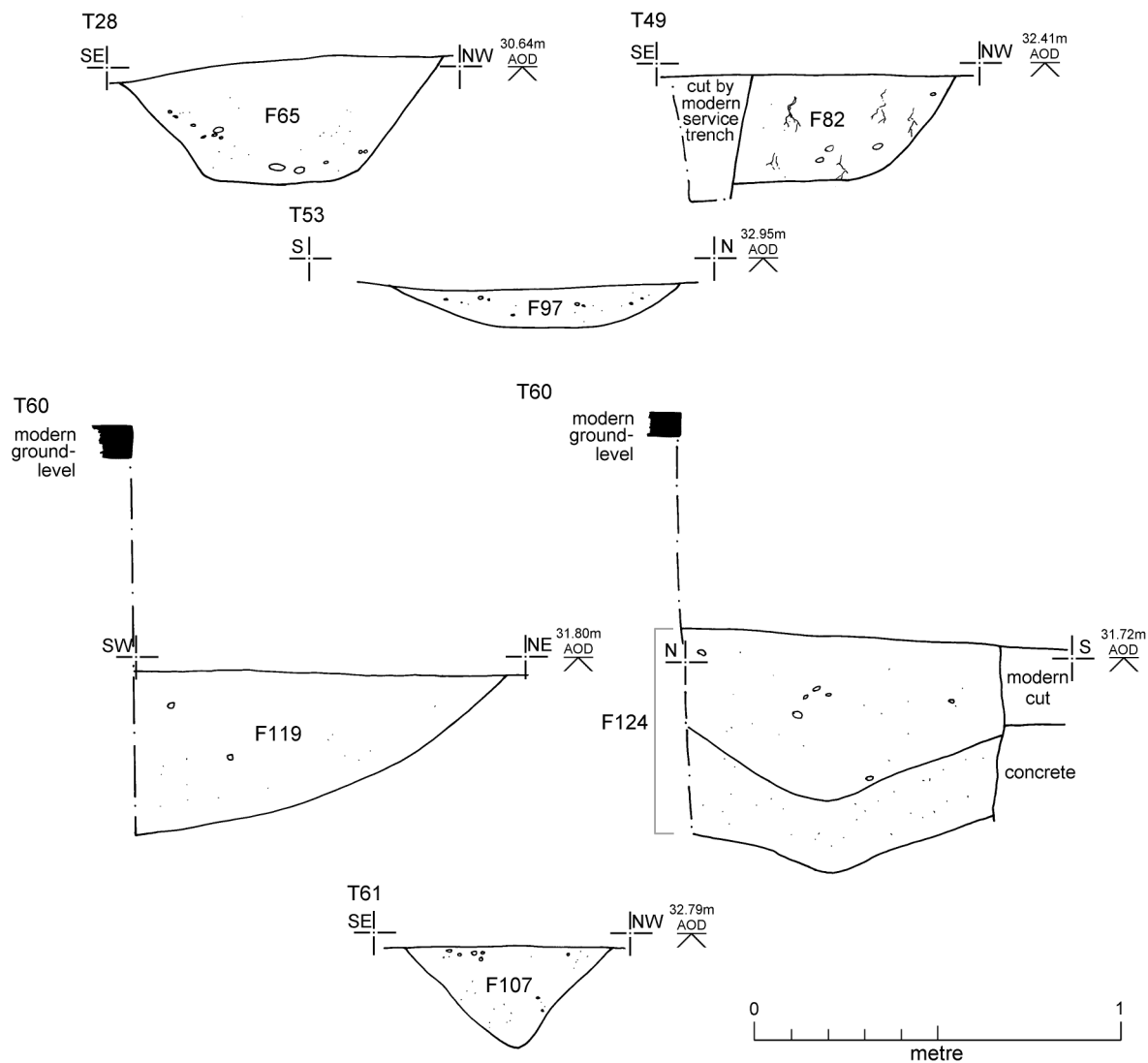

Fig 12 T17, T18, T21: Roman ditch sections.



Roman post-holes

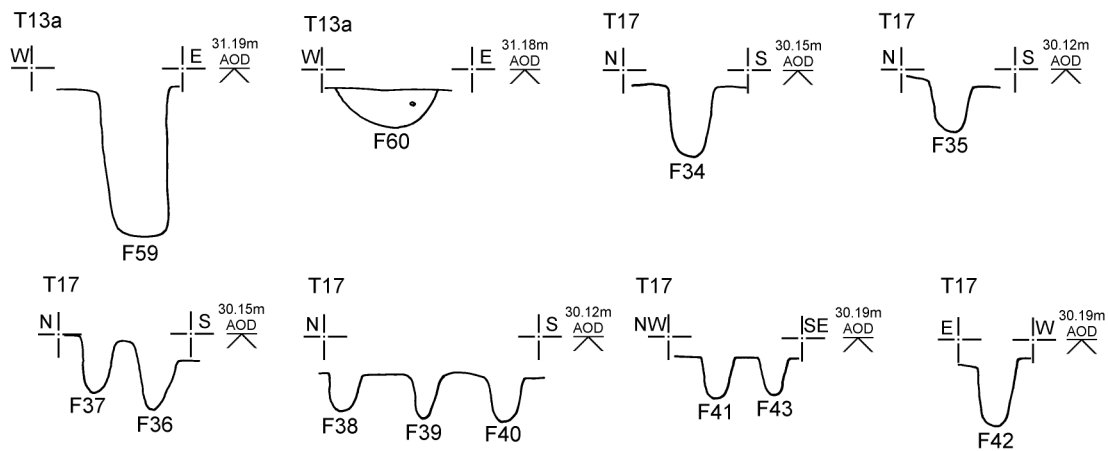
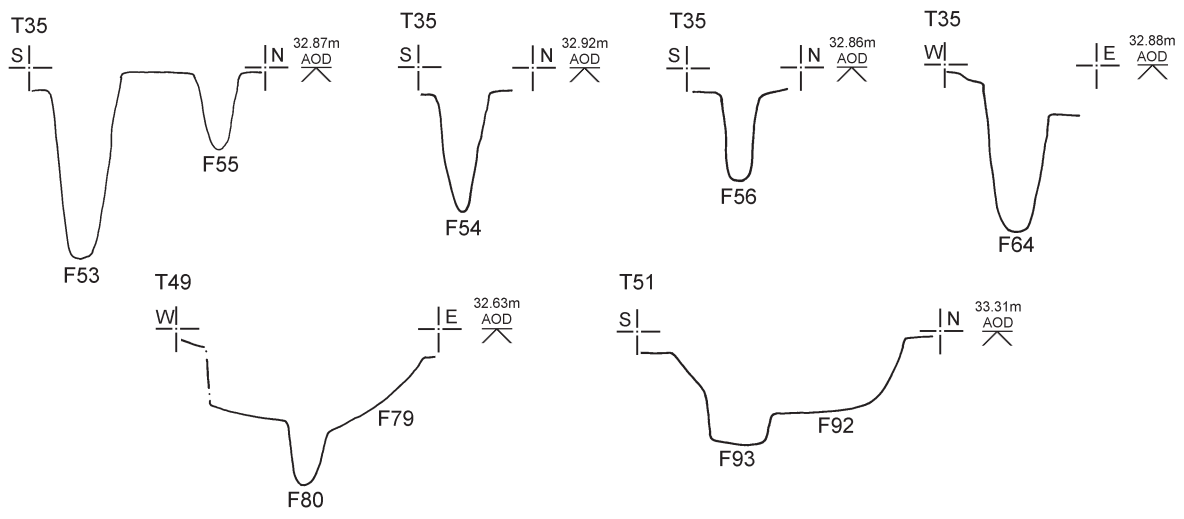
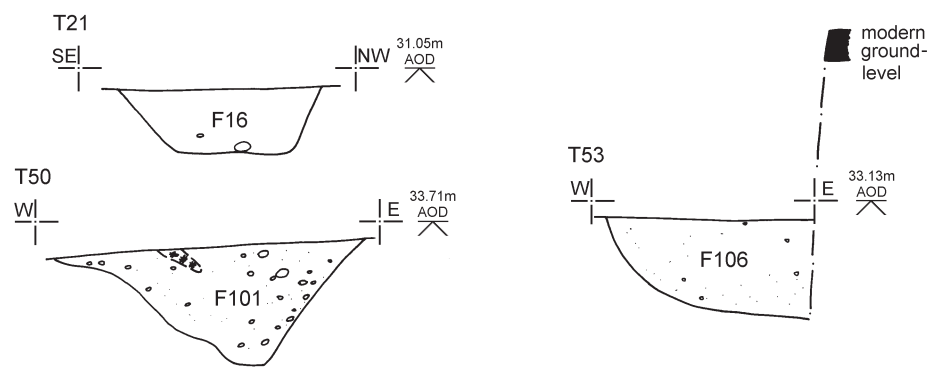

Fig 13 T28, T49, T60, T61: Roman ditch sections; T13, T17: Roman post-hole sections and profiles.



Roman pits



Natural features

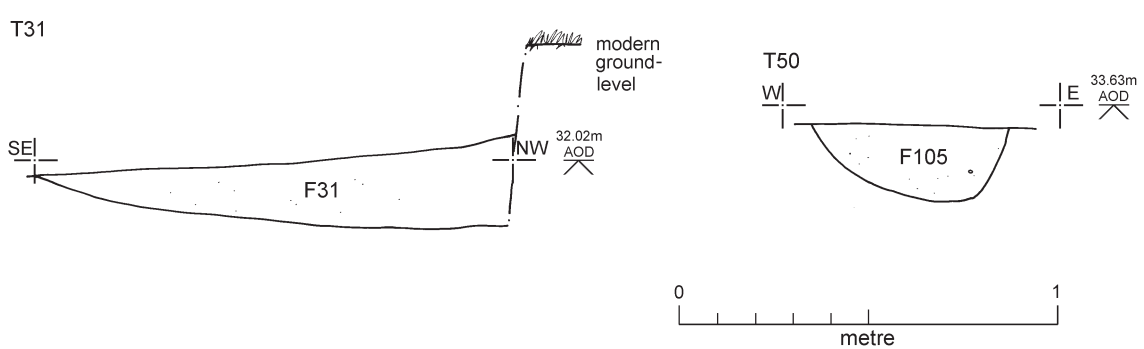

Fig 14 T35, T51: Roman post-hole profiles; T21, T50, T53: Roman pit sections; T31, T50: natural feature sections.

Post-medieval ditches

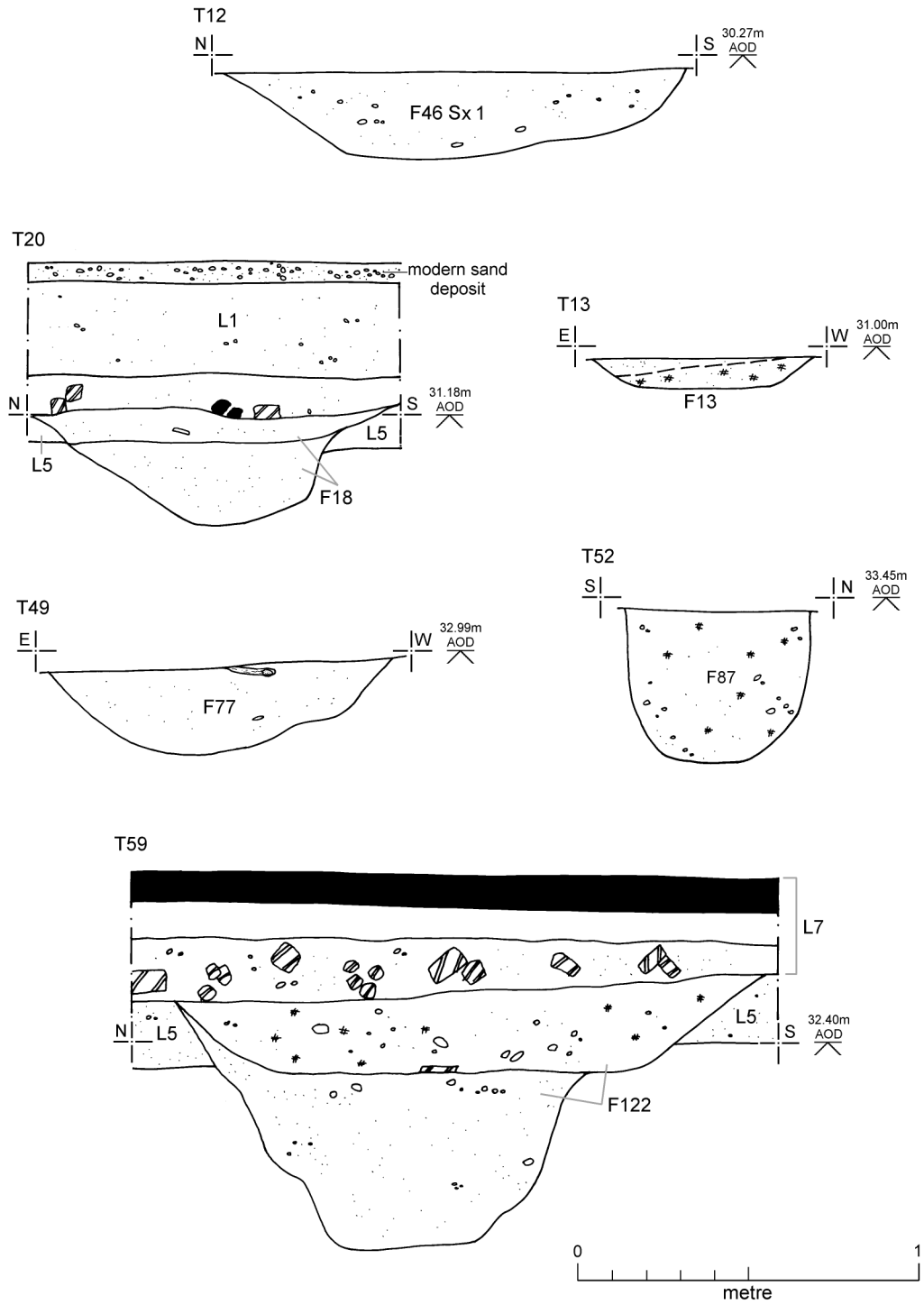

Fig 15 T12, T13, T20, T49, T52, T59: post-medieval ditch sections.

Post-medieval pits

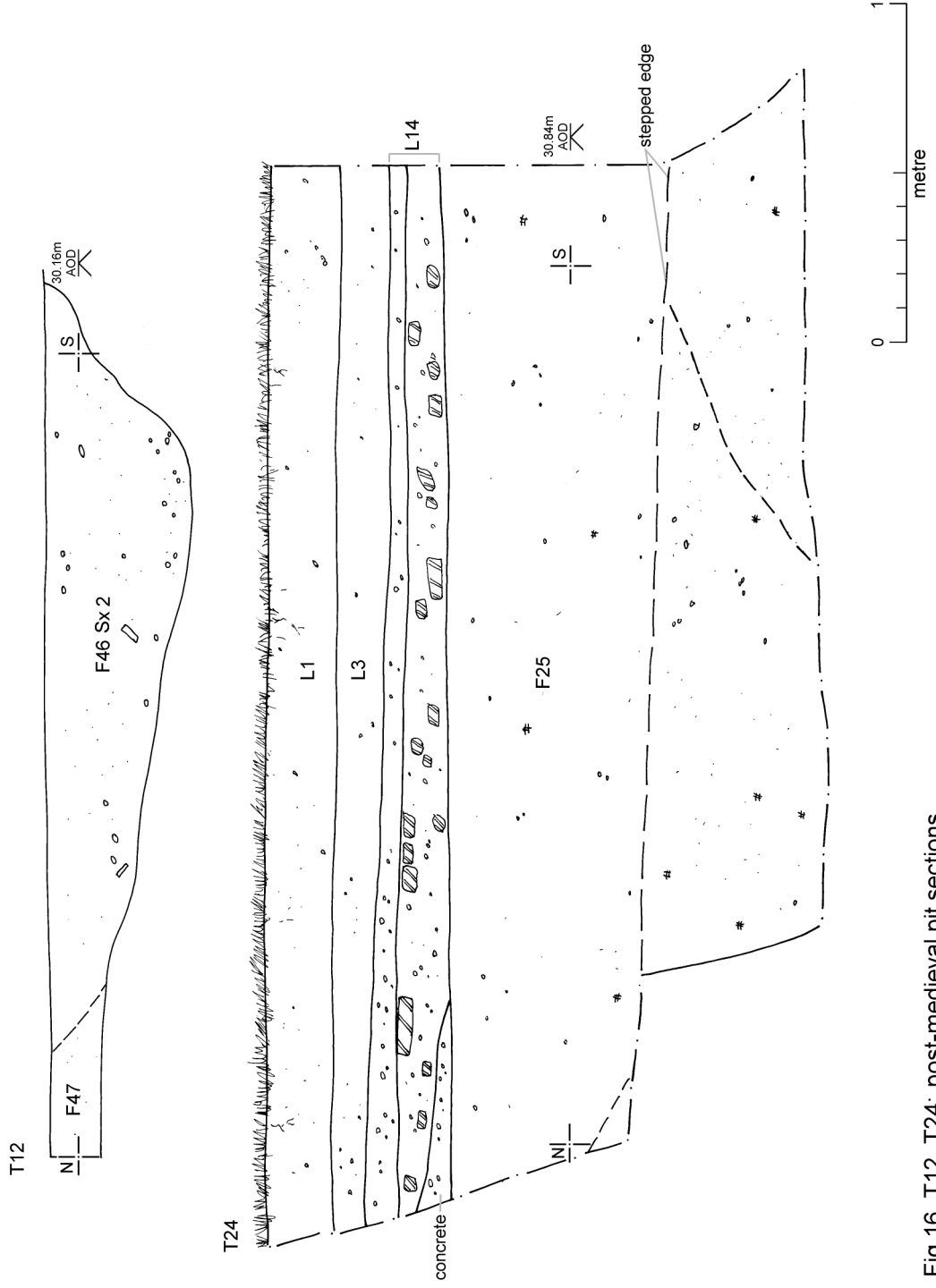
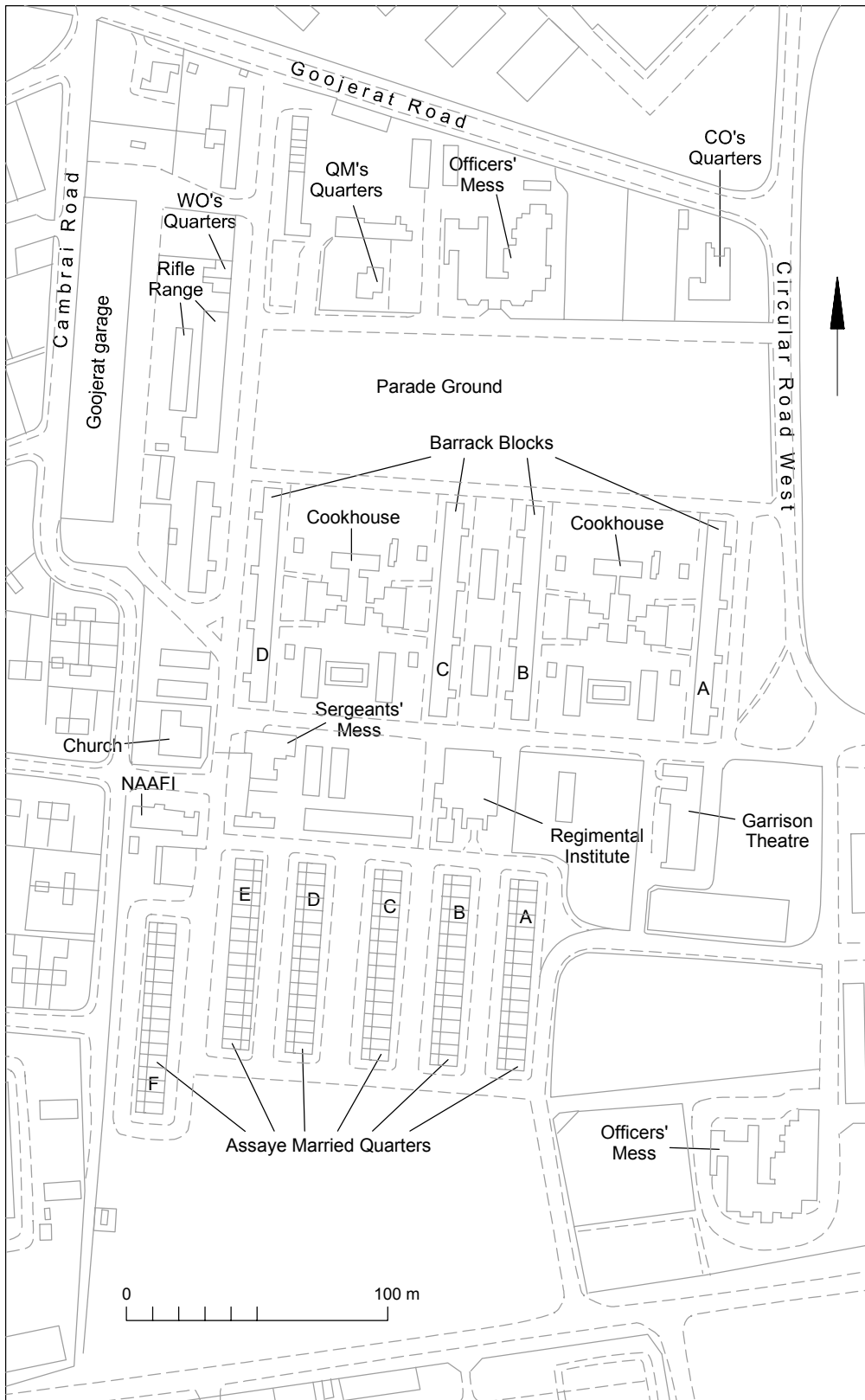

Fig 16 T12, T24: post-medieval pit sections.



© Crown copyright. All rights reserved. Licence number 100039294.

Fig 17 Royal Engineers' 1949 plan of Colchester Garrison (area of Goojerat Barracks).

**Essex Historic Environment Record/
Essex Archaeology and History**

Summary sheet

Site address: Alienated Land Area L/N, Colchester Garrison, Colchester, Essex	
Parish: Colchester	District: Colchester
NGR: TL 99512 24510 (c)	Site code: Museum accession code COLEM 2006.127
Type of work: Evaluation	Site director/group: Colchester Archaeological Trust
Date of work: 8th-23rd October 2007	Size of area investigated: 62 trenches (total length 1,199m, width 1.8m) in a site of approx 8.57ha
Location of finds/curating museum: Colchester and Ipswich Museums	Funding source: Developer
Further seasons anticipated? Unknown	Related UAD nos: 1250
Final report: CAT Report 456 and summary in <i>EAH</i>	
Periods represented: Late Iron Age, Roman, post-medieval, modern	
<p>Summary of fieldwork results: <i>Colchester Garrison Alienated Land Area L/N coincides with the Goojerat Barracks south of Goojerat Road and east of Cambrai Road.</i></p> <p><i>The principal remains revealed by the 62 evaluation trenches were the widespread remains of barrack buildings. Around and under the buildings there were extensive areas where the ground had been reduced (ie truncated) or built up (ie infilled). This truncation and infilling is undoubtedly due to large-scale landscaping carried out when Goojerat Barracks was constructed in 1900-1902, or when it was rebuilt in 1971-75.</i></p> <p><i>The truncation has severely affected the survival of earlier archaeological horizons and features. Only nine Roman and two post-medieval ditches were identified, plus a number of Roman post-holes.</i></p> <p><i>The post-medieval ditches defined parts of a pre-Garrison landscape, or may have been associated with the Civil War, when Colchester was besieged in 1648.</i></p> <p><i>The alignment of the Roman ditches in Area L/N indicates that there was a co-axial Roman farmed landscape here, aligned south-west to north-east and north-west to south-east. Further, the configuration of the Roman ditches and the presence of over 11kg of Roman building materials may indicate the presence of a rectangular Roman enclosure, possibly containing a robbed-out Roman structure, in the south-east corner of Area L/N.</i></p> <p><i>A simple Roman 'villa-type' agricultural establishment has been identified at the Kirkee McMunn Barracks (approximately 1km to the south of this site), and a smaller-scale Roman settlement has recently been identified in GAL Area E (approximately 500m to the north-east). It remains to be seen how the Area L/N building fitted into this Roman farmed and inhabited landscape.</i></p>	
Previous summaries/reports: CAT Report 206	
Author of summary: H Brooks and B Holloway	Date of summary: March 2008