

# Swindon Gateway Coate Swindon Wiltshire



## Archaeological Evaluation and Fieldwalking Survey Report



April 2006

**Client: John Samuels  
Archaeological Consulting**

Issue N<sup>o</sup>: 1  
OA Job N<sup>o</sup>: 2961  
NGR: SU 1580 8150

**Client Name:** John Samuels Archaeological Consulting

**Client Ref No:**

**Document Title:** Archaeological Evaluation Report, Swindon Gateway

**Document Type:** Evaluation

**Issue Number:** 1

National Grid Reference: NGR SU1850 8150

Planning Reference:

OA Job Number: 2961

Site Code: B 2005/14

Invoice Code: SWGATEEV

Receiving Museum: Wiltshire County Museum

Museum Accession No:

Prepared by: Rob Tannahill/ Melanie

Pomeroy-Kellinger

Position: Project Officer/Senior Project Manager

Date: 6th April 2006

Checked by: Melanie Pomeroy-

Kellinger

Position: Senior Project Manager

Date: 6th April 2006

Approved by: Bob Williams Signed.....

Position: Director, Operations and Business Development

Date: 6th April 2006

Document File Location X:/Swindon Gateway\evaluation\SWGATEfullreport.wbk

Graphics File Location \\Servergo\invoice codes r thru z\S\_codes\SWGATEEV

Illustrated by Lucy Martin / David Lock

**Disclaimer:**

*This document has been prepared for the titled project or named part thereof and should not be relied upon or used for any other project without an independent check being carried out as to its suitability and prior written authority of Oxford Archaeology being obtained. Oxford Archaeology accepts no responsibility or liability for the consequences of this document being used for a purpose other than the purposes for which it was commissioned. Any person/party using or relying on the document for such other purposes agrees, and will by such use or reliance be taken to confirm their agreement to indemnify Oxford Archaeology for all loss or damage resulting therefrom. Oxford Archaeology accepts no responsibility or liability for this document to any party other than the person/party by whom it was commissioned.*

**Oxford Archaeology**

© Oxford Archaeological Unit Ltd 2006

Janus House

Osney Mead

Oxford OX2 0ES

t: (0044) 01865 263800

e: info@oxfordarch.co.uk

f: (0044) 01865 793496

w: www.oxfordarch.co.uk

Oxford Archaeological Unit Limited is a Registered Charity No: 285627

**Swindon Gateway, Coate, Swindon, Wiltshire****NGR SU 1580 8150*****ARCHAEOLOGICAL EVALUATION REPORT*****CONTENTS**

Summary .....	1
1 Introduction .....	1
1.1 Location and scope of work .....	1
1.2 Geology and topography .....	1
1.3 Archaeological background.....	2
2 Evaluation Aims .....	2
3 Evaluation Methodology .....	2
3.1 Scope of fieldwork .....	2
3.2 Fieldwork methods and recording .....	3
3.3 Fieldwalking survey .....	3
3.4 Palaeo-environmental evidence.....	4
3.5 Finds .....	4
4 Results: General.....	4
4.1 Soils and ground conditions .....	4
4.2 Distribution of archaeological deposits .....	5
5 Results: Descriptions .....	5
5.1 Description of deposits .....	5
5.2 Finds .....	18
5.3 Palaeo-environmental remains .....	28
5.4 Results from Fieldwalking and Finds.....	29
6 Discussion And Interpretation .....	36
6.1 Reliability of field investigation.....	36
6.2 Overall interpretation.....	36
Appendix 1 Archaeological Context Inventory.....	39
Appendix 2 Pottery assessment/ spot dating .....	70
Appendix 3 Worked flint.....	73
Appendix 4 Environmental data.....	75
Appendix 5 Ceramic Building Material (CBM).....	77
Appendix 6 Bibliography and references .....	77
Appendix 7 Summary of Site Details.....	79

**LIST OF FIGURES**

- Fig. 1 Site location map  
 Fig. 2 Distribution of areas and trench locations  
 Fig. 3 Area 1  
 Fig. 4 Area 2  
 Fig. 5 Area 3  
 Fig. 6 Area 4 a  
 Fig. 7 Area 4 b  
 Fig. 8 Area 5  
 Fig. 9 Area 6  
 Fig. 10 Area 7 a

- Fig. 11 Area 7 b  
Fig. 12 Area 8  
Fig. 13 Area 9  
Fig. 14 Trench 1 plan and selected sections  
Fig. 15 Trench 2 plan and selected sections  
Fig. 16 Trench 3 plan and selected sections  
Fig. 17 Trench 4 plan and selected sections  
Fig. 18 Trench 5 plan and selected section  
Fig. 19 Trench 6 plan and selected section  
Fig. 20 Trench 8 plan and selected section  
Fig. 21 Trench 15 plan and selected section  
Fig. 22 Trench 17 plan and selected sections  
Fig. 23 Trench 19 plan and selected sections  
Fig. 24 Trench 21 plan and selected section  
Fig. 25 Trench 24 plan and selected section  
Fig. 26 Trench 29 plan and selected sections  
Fig. 27 Trench 52 plan and selected section  
Fig. 28 Trench 53 plan and selected section  
Fig. 29 Trench 74 plan and selected section  
Fig. 30 Trench 79 plan and selected section  
Fig. 31 Trench 83 plan and selected section  
Fig. 32 Trench 84 plan and selected sections  
Fig. 33 Trench 85 plan and selected section  
Fig. 34 Trench 91 plan  
Fig. 35 Trench 92 plan  
Fig. 36 Trench 93 plan  
Fig. 37 Fieldwalking transect location  
Fig. 38 Fieldwalking distribution of worked flint  
Fig. 39 Fieldwalking flint density plot  
Fig. 40 Fieldwalking distribution of datable flint artefacts  
Fig. 41 Fieldwalking pottery location plot

## SUMMARY

*In December 2005 and February-March 2006 Oxford Archaeology (OA) carried out a field evaluation on behalf of John Samuels Archaeological Consultants (JSAC) on the proposed Swindon Gateway development, Coate, Swindon, Wiltshire (NGR SU 1580 8150). A total of 84 trenches were excavated of which 48 contained archaeological features other than medieval ridge and furrow. Fieldwalking survey (surface artefact collection) was also undertaken across a 20 hectare field in the north-west of the site. The evaluation has defined areas of known archaeological potential, as well as identifying previously unknown ones. In total 315 features were identified, 128 of which can be dated by pottery. The evaluation demonstrated the survival of a range of archaeological features and activity areas distributed across most of the landscape, dating from the Late Mesolithic, Bronze Age, Iron Age, Roman and Medieval periods.*

## 1 INTRODUCTION

### 1.1 *Location and scope of work*

- 1.1.1 Oxford Archaeology (OA) has been commissioned by John Samuels Archaeological Consultants (JSAC), acting on behalf of DPDS Ltd, representing Redrow and Persimmon, to undertake an archaeological evaluation on the site of the proposed Swindon Gateway development. The proposed development is to include a university campus and residential districts covering an area of 160 hectares.
- 1.1.2 A specification for the work was prepared by JSAC (JSAC 2005) and approved by Roy Canham, County Archaeologist for Wiltshire. A desk-based assessment and survey work has been previously undertaken on the site (discussed below in Section 1.3).
- 1.1.3 The site lies to the south-east of Swindon in Wiltshire (Figure 1). It is bounded to the north by the A4259, to the east by the A419, and to the south by the M4 motorway. The Coate Water reservoir lies close to the site's western boundary. The two main farms and landholdings within the site are at Badbury Wick and Day House.

### 1.2 *Geology and topography*

- 1.2.1 The site generally lies at between 110 and 120 m above OD and is gently undulating in places. The lower-lying parts of the site, especially the southern, areas are prone to seasonal waterlogging.
- 1.2.2 The geology of the site is complex and comprises a variety of underlying solid rocks and junctions between clay-rich sequences. The southern part of the site is dominated by clay-rich soils mostly Gault clay deposits. The central part of the site has an area of Greensand, bordered by an area of Portland sand to the north-east of it (east of Day House). The north-east and north-west areas of the site are dominated by Kimmeridge clay.

- 1.2.3 The current land use is agricultural, comprising mainly permanent pasture with some arable on undulating areas to the west and east of Day House.

### 1.3 *Archaeological background*

- 1.3.1 The site itself contains significant archaeological remains, including two prehistoric scheduled monuments (SM20264 and SM28971). There are surviving earthworks relating to prehistoric ritual monuments close to Day House and of medieval and post-medieval settlement at Badbury Wick. There are several known sites with archaeological remains within and adjacent to the development area.
- 1.3.2 The archaeological background to the evaluation has been the subject of a separate desk study (JSAC 2003) and non-invasive field evaluation, the results of which are summarised below.
- 1.3.3 Non-invasive evaluation undertaken included an aerial photographic survey (Air Photo Services 2004), two earthwork surveys (Corney and Morris 2004), and gradiometer and resistance survey (Pre-Construct Geophysics 2005).
- 1.3.4 The results from the desk-based assessment and survey work indicated that there is high potential in this proposed development site for archaeological remains, especially from the Prehistoric, Roman and Medieval periods. The survey results suggest a possible linear cemetery dating to the Bronze Age in the north-east of the site, as well as possible later settlement activity to the north-east and south-west. There is much evidence of Roman activity in the general area, with a Roman road (under the A419) forming part of the eastern site boundary and a recently-excavated Roman farmstead located nearby at the site of the Great Western Hospital.

## 2 **EVALUATION AIMS**

- 2.1.1 To establish the presence/absence of archaeological remains within the proposal area.
- 2.1.2 To determine the extent, condition, nature, character, quality and date of any archaeological remains present. In this case in particularly Prehistoric, Roman and Medieval deposits.
- 2.1.3 To establish the basis for further evaluation or a mitigation strategy.
- 2.1.4 To establish the ecofactual and environmental potential of archaeological deposits and features.
- 2.1.5 To define any relevant research priorities if additional archaeological investigation and mitigation proves necessary.

## 3 **EVALUATION METHODOLOGY**

### 3.1 *Scope of fieldwork*

3.1.1 This programme of trenching was intended to form part of a phased approach to evaluation of this development site, providing an indication of the potential of the archaeological resource and a guide to the consideration of further trenching work. 83 trenches measuring 50 m by 2.0 m were excavated (although some of these were slightly shorter when circumstances did not allow their full lengths to be excavated) plus one 100 m trench, representing a 0.5% sample of the proposed development area (Figure 2). A further 10 trenches had been planned, but could not be excavated at the time of the evaluation because of flooding or access difficulties. The majority of trenches in this phase of evaluation were located in respect to known archaeological features. Following the discovery of a large number of worked flints during the setting out of Trench 34 in Area 4, east of Day House, a fieldwalking survey of this 20 hectare field was carried out as part of the evaluation in agreement with the County Archaeologist and JSAC.

### 3.2 *Fieldwork methods and recording*

- 3.2.1 The evaluation trenches were excavated by a mechanical excavator (360° tracked vehicle and JCB) with a toothless ditching bucket under archaeological supervision, supplemented by limited hand excavation of archaeological deposits for their initial dating and characterisation. The trenches were located, so far as possible, to obtain a representative sample of the areas most at risk from the current proposals.
- 3.2.2 The trenches were excavated to the top of the 'natural' or to the top of any significant archaeological level, whichever was the higher. The exposed archaeological horizon was cleaned and archaeological features sampled to sufficiently characterise and date them. However, in some cases, following advice from the County Archaeologist, some trenches were only subjected to very limited excavation in order to best preserve dense or fragile features. Particular care was taken to ensure that archaeological deposits were not damaged through excessive use of machine excavation.
- 3.2.3 Spoil heaps were monitored to allow analysis of the spatial distribution of artefacts.
- 3.2.4 Roy Canham, County Archaeologist, undertook monitoring of the evaluation for Wiltshire County Council.
- 3.2.5 All archaeological features were planned and where excavated their sections drawn at scales of 1:20. All features were photographed using colour slide and black and white print film. Recording followed procedures outlined in the *OAU Fieldwork Manual* (Oxford Archaeology, 1992).

### 3.3 *Fieldwalking survey*

- 3.3.1 The 20 hectare field in Area 4 which was fieldwalked had been ploughed and left to weather and fairly recently planted with a low winter crop.

- 3.3.2 The field was divided into 100 by 100 m grid squares, aligned on the OS grid and numbered 1-29 (Figure 37). Each grid square was divided into north-south transects 20 m apart and 20 m in length. Thus, for each hectare there were 25 collection units.
- 3.3.3 When walking the transect lines, the archaeologists collected material from 50 cm either side of the line, thus having a collection unit of one metre by 20 metres. For each of these units, a fieldwalking record sheet was completed with information relating to the items collected, soils, and topography and weather conditions.
- 3.3.4 The survey was focused on the collection of lithic material. A decision was made to collect any pottery, which may be prehistoric but not obviously later pottery or CBM. Any concentrations of later material were to be sampled instead. The finds recovered were processed and quantified and the data entered into a database to generate find density plots (Figures 38-41).
- 3.3.5 The fieldwalking survey was completed in five days by a team of five archaeologists and in total 500 transects were walked

#### 3.4 *Palaeo-environmental evidence*

- 3.4.1 Fifteen bulk samples were taken during the course of the evaluation. The results are discussed below in section 5.4 and a summary of the charred plant remains is presented in Appendix 4.

#### 3.5 *Finds*

Finds were recovered by hand during the course of the excavation and generally bagged by context. Finds of special interest were given a unique small find number.

#### 3.6 *Presentation of results*

- 3.6.1 A general description of the archaeological features and their distribution is given below. The 36 trenches with no archaeological features have not been included or described. The trenches have been grouped into areas to aid description and interpretation (Figures 3-13). 23 trenches have been illustrated in detail (Figures 14-36).
- 3.6.2 The trench descriptions are followed by a presentation of results for the fieldwalking survey, and by a summary and discussion of the results. A table detailing individual contexts is given in Appendix 1.

### 4 **RESULTS: GENERAL**

#### 4.1 *Soils and ground conditions*

- 4.1.1 The study area was mainly gradually undulating clayland that was prone to severe waterlogging. Adverse weather, particularly heavy rainfall during the evaluation in December created difficult working conditions. All the trenches that were opened were subject to varying degrees of flooding. The underlying natural clays provided poor drainage and quickly became waterlogged. Earthworks associated with medieval



ridge and furrow agriculture, which were well preserved across much of the site, exacerbated these problems by draining surface water directly into the trenches. Under these conditions the archaeological horizons became very soft. With the agreement of Roy Canham, County Archaeologist for Wiltshire, a strategy for archaeological investigation within the affected trenches was implemented. Within trenches opened over areas with high archaeological potential the features were planned and finds were collected from the surface of in situ deposits and associated machine excavated spoil. Only a limited number of interventions were cut into the archaeological features. In addition, the ground conditions prevented the full excavation of some of the deeper features which were augured to determine their nature and depth.

- 4.1.2 The 20 hectare field which was fieldwalked had been cultivated a few weeks prior and planted with a low crop of winter wheat. Although the crop took up about a quarter to a third of the visible ground surface, visibility was generally good, as the soil had weathered since the last episode of ploughing and recent rain had aided visibility of the flint. The weather conditions during the survey were generally sunny, frosty and cold with good light conditions. The collection conditions were in general good to very good, aided by the underlying sandy soil.

#### 4.2 *Distribution of archaeological deposits*

- 4.2.1 A total of 48 trenches contained archaeological features or deposits, and they were distributed across all areas of the site, with the exception of Areas 5 and 10. In total, 315 archaeological features were identified and recorded, 128 of which can be dated by pottery.

### 5 RESULTS: DESCRIPTIONS

#### 5.1 *Description of deposits*

##### *Area 1. North of Day House Farm (Trenches 1-10) Figure 3.*

- 5.1.1 The area immediately to the east of Day House Lane was shown to have a high archaeological potential, with evidence of activity in the area in the later prehistoric and Roman periods. Low earthwork remains cover the northern part of this field. Detailed earthwork survey was undertaken here (Corney and Morris, 2005) and the trenches located in respect to some of the features identified. The archaeological features were concentrated in the pasture fields in the north-west, particularly within Trenches 1 and 2. This is the area close to the extant Bronze Age burial mound, Scheduled Monument number 28971, which survives to a height of 0.5 m. From here the archaeological features declined in density towards the south and east, with Trench 9 being the only one devoid of archaeology. Preservation was generally good with medieval and modern farming methods having made little impact on the surviving remains, which were generally fairly shallow-cut ditches and pits. Because of the density of archaeological features and wet weather conditions during the evaluation in this area, the County Archaeologist advised us that only a limited amount of investigation of the features should be undertaken. Hence, much of the

dating evidence for this area come from artefacts found on the top of features revealed by the machine -stripping rather than from securely within them.

- 5.1.2 Trench 1 (Figure 14) contained approximately 12 linear and curvilinear features, probably enclosure ditches, and 18 discrete features (mostly sub-circular and linear pits) and a small number of post holes. Finds recovered from the top of these features date to the late Prehistoric, late Iron Age, and early Roman periods.
- 5.1.3 A series of shallow intercutting pits or scoops (129 and 161) appeared to form a square or sub-rectangular enclosure extending towards the north-west (Section 101). Pottery sherds dating to the late Iron Age were recovered from the fill of one of the pits.
- 5.1.4 Ditch 155 was aligned SW-NE and may have formed part of an early boundary. The pottery recovered from its fill (156) was dated to the late Prehistoric period and is likely to be fragments of a base of a middle Bronze Age vessel.
- 5.1.5 Ditch 105 may correspond to a penannular enclosure recorded in the geophysical survey. This feature was probably cut in the late Iron Age and was completely silted by the early Roman period. An internal bank (Section 102) was preserved on its southern side. This bank was later cut by what appeared to be a system of enclosure ditches (107) aligned NE-SW with adjoining ditches aligned NW-SE. No dating evidence was retrieved from these features.
- 5.1.6 A similar concentration of archaeological features was recorded in Trench 2 (Figure 15) which contained approximately 9 linear features and 13 discrete features represented by pits and postholes. Pottery dating to the late Iron Age was recovered from several of the ditch fills as well as flint.
- 5.1.7 The largest ditch (209) was 4.5 m wide (Section 202). Ditch 225 (Section 206) appears to have been truncated by a tree hole at the southern side, indicating that hedges may have originally lined the ditch.
- 5.1.8 Ditch 207 may correspond to a circular feature recorded during the geophysical survey and interpreted in the earthwork survey as a possible barrow (Corney and Morris 2005, feature 17), although there is no dating evidence for this feature. Ditch 246 which had flint and late Iron Age pot in its fill truncated Ditch 250 (Sections 203).
- 5.1.9 Trench 3 (Figure 16) contained three east-west ditches. Ditch 303 contained pottery dated to the Roman period and was deeper than the other two (Sections 301). Ditch 306 was shallower and had pottery dating to the late prehistoric period. Ditch 308 was also shallow (Section 303) and was undated. As in other trenches in this area, there were several irregular dark deposits, which, after investigation were found to be the results of root disturbance.
- 5.1.10 Trench 4 (Figure 17) is located in a cultivated field in the east side of Area 1, together with Trenches 7 and 10. It contained seven linear features most of which are dated by pottery to the late Iron Age and Roman or early Roman period. The widest ditch

(420) is 2.20 m wide and is flat-bottomed (Section 411) and it is possible that it may be a continuation (albeit wider in profile) of one in Trench 3. Ditch 409 appears to terminate within the trench (Section 403).

- 5.1.11 Trench 5 (Figure 18) is located within 50 m of the extant Bronze Age barrow. As well as a number of gullies and ditches, it contained pits in the centre of the trench. Pit 503 could possibly contain a stone socket. Pit 505 could also have been a ditch terminal. It contained flint and pottery dated to the late Iron Age. The fill of ditch 511 (Section 503) at the north end of the trench contained early Roman pottery. This feature was truncated by Pit 507. It is possible that some of these features were associated with the construction or use of the barrow, although no Bronze Age pottery has been recovered from the trench.
- 5.1.12 Trench 6 (Figure 19) contains six linear features (ditches and gullies) at different orientations, several of which are dated by pottery to the late Iron Age and one to the early Roman period. At the west end of the trench are two parallel curvilinear ditches (604 and 603) and the relationship between the two is not fully understood as the fills were very similar (Section 600). Feature 611 is the terminus of a shallow ditch, which cuts the remains of a hedgerow (613). As several linear features appear to terminate or turn within the trench, it could be on or near the boundary of an activity area.
- 5.1.13 Trench 7 contained one ditch running east-west (703/5) and a possible ditch terminus or pit (707). There is no dating evidence from the features in this trench but it is possible that the ditch may be a continuation of one of the linear features in Trench 6.
- 5.1.14 Trench 8 (Figure 20) contained three linear features, a spread of material (unexcavated) and two pits. The ill-defined spread (808) had a piece of flint which was in a fresh condition and likely to be contemporary with features rather than residual. The fill of curvilinear Ditch 811 was dated by fragments of early Iron Age pottery (Section 801). This ditch was steep-sided and flat-bottomed in profile and cuts one of the two pits (813).
- 5.1.15 Trench 10 contained one ditch (1004) and a possible posthole (1012). The fill of 1004 contained pot dating to the late Iron Age. Other possible features in the trench upon investigation turned out to be areas of bioturbation. Ploughmarks ran north-south across the trench and were sealed by a thin layer of natural clay, indicating that they are probably quite old.
- 5.1.16 In this area there seems to be a good correlation between the SMR data (geophysics and earthwork survey transcriptions) and the features revealed in the trenches.

#### ***Area 2. North-east of Day House (Trenches 11-13, 30-33) Figure 4.***

- 5.1.17 Relatively few archaeological features were found in Trenches 11-13 in the northern part of this area. Trench 11 contained one linear feature running north-south, and a gully, which was U-shaped in profile. Trench 12 contained two inter-cutting wide ditches (1204 and 1205) which appeared contemporary. During excavation it was thought that the ditches were probably relatively modern as they could still be seen on

the ground as slight negative earthworks running across the field and towards the field boundary. However, a piece of Roman CBM was recovered from ditch fill 1202. Similarly, Trench 13 contained two ditches (1305, 1310) which were fairly deep and contained pieces of flint. There were also two shallower gullies with no finds.

- 5.1.18 By contrast, Trenches 30-33 in the southern part of this area are rich in archaeological finds. Prehistoric pottery and flint in the topsoil indicate early activity in the vicinity of Trenches 30-33, hinting that some stratigraphically earlier features seen in the trenches may be prehistoric. In addition there is evidence in all three trenches of intensive Roman occupation.
- 5.1.19 Because of the wet weather conditions and intensity of deposits in these trenches interventions were limited, by agreement with the County Archaeologist. Only one intervention was excavated into a Roman feature, but this was not fully excavated because of ground water. The water table in this area was just above the machined level and the trenches flooded as soon as they were opened. However, trenches were planned and finds were recovered and bagged by context from the surface of the features.
- 5.1.20 Artefacts recovered from the topsoil of these trenches, especially 30 and 31, helps to illustrate the main area of occupation or dumping of refuse. It included flint, tile, slag, pottery, and bone, dated to the prehistoric period, Roman, Medieval and post-medieval.
- 5.1.21 There was an occupation spread, probably sealing earlier features at north end of Trench 31 (3110) and western end of Trench 30 (3003, 3004). This deposit was split into two contexts within Trench 31 to divide finds into two areas. It contained pot, tile, including box tile, dating to early and late Roman period. This layer was also recorded in Trench 32 where it survived as a thin spread that was removed by machine to reveal archaeology.
- 5.1.22 Trench 30 contained two ditches, both unexcavated. Flint and pieces of Roman box flue tile were found on the surface of one ditch fill (3008).
- 5.1.23 In Trench 31, seven ditches and a ditch terminus were recorded in plan. Ditch 3105 was sectioned and late Roman pottery was recovered from its fill. Early Roman pottery was recovered from the surface of ditches 3115 and 3117. There was also a possible posthole (3123).
- 5.1.24 In Trench 32, eight ditches, one gully and two postholes were recorded in plan, though none were excavated. Roman pot and tile was recovered from the top of ditch fill 3211 and 3207.
- 5.1.25 Trench 33 contained five linear features running east-west. A further ditch (3303) ran north-south for half the length of the trench and Roman pot was recovered from the top of its fill.
- 5.1.26 There seems to be a good correlation between the transcription of the geophysical survey results in the field to the features in the trenches, although the alignment is

slightly off. The rectangular feature recorded by geophysics between the north end of Trench 31 and the west end of Trench 30 (Figure 6) may be a building and account for the occupation spread. Roman flue tiles were recovered from the area.

***Area 3. North-east of Day House (Trenches 14-21, 25-27, 29) Figure 5.***

- 5.1.27 This area, which is mostly cultivated land on Greensand with the land sloping up gently towards the east. Neolithic and Bronze Age Flint was noted in the topsoil, especially in the north-east part of the area. Flint from contexts in Trenches 17 and 19 also seem to have Mesolithic components, similar to that discussed in relation to Area 4.
- 5.1.28 In the north-west part of this area, Trenches 14, 16 and 18 contained a limited number of features. Trench 14 contained several gullies and the remains of a hedgeline, all of which were likely to be relatively modern. Trench 16 contained the shallow remains of a wide pit (1603) and several gullies, none with dating evidence. Similarly, Trench 18 contained one shallow U-shaped ditch (1802) of uncertain date.
- 5.1.29 Trench 15 (Figure 21) contained evidence of ten ditches and one posthole (1509). Ditch 1521 was aligned east-west and was cut by a deeper ditch (1523) on the same alignment (Section 1507). Ditch 1516 contained flint and ditch 1518 late Iron Age pottery.
- 5.1.30 Trench 17 (Figure 22) contained one pit (1703) with a flint blade and piece of burnt stone (Section 1700). A series of five north-south ditches and gullies also ran across the trench. Ditch 1705 was 2 m wide (Section 1701) and its fill (1707) contained flint which was in fresh condition, likely to be contemporary with the features rather than residual. This fill also contained wood charcoal and small pieces of burnt clay (recovered in sieved environmental samples) in which plant impressions were observed, and many worn fragments of middle Bronze Age Barrel Urn pottery, some with decoration.
- 5.1.31 Trench 19 (Figure 23) contained three linear features and a posthole. Lithics were found in the topsoil, but no other dating evidence in any of the features. Two of the ditch profiles were steep and over a metre wide. No evidence for a mound was detected on either side of the ditches. Ditch 1905 (Section 900) and 1908 (Section 901) are likely to be the ditches of a barrow feature, which correspond to an enclosure on the geophysics plots in the field referred to in the survey report as 20b, where a well defined ring ditch 25 m in diameter was identified (Bunn and Masters 2005, page 12).
- 5.1.32 Trench 20 contained two ditches and two gullies. Ditch 2003 was 2 m wide and contained flint in its fill. Ditch 2005 was slightly narrower and had flint and middle Bronze Age pottery in its fill.
- 5.1.33 Trench 21 (Figure 24) contained several ditches, stakeholes, a pit and a possible bank. Ditch 2107 was almost 2 m wide, with gently sloping sides and a round-bottom

(Section 2100). It had bank material (211-213) on its north-east side, formed of lenses of re-deposited natural soil.

- 5.1.34 Trench 24 (Figure 25) A single flat-bottomed ditch (2404) was found in this trench (Section 2401). No finds were recovered.
- 5.1.35 Trenches 25 and 28. No archaeological features were recorded from these trenches, although flints were recovered from the topsoil of Trench 25.
- 5.1.36 Trench 26. One north-south ditch was contained within the trench (2609) and was over 3 m wide. It had an irregular base, which was probably the result of root action. A small number of gullies and furrows were also recorded. One (unexcavated) furrow (2608) had Roman pottery on the top of its fill. A strip lynchet (2612) was observed in the trench which was 0.2 m high within the trench. It appears to be in line with a linear feature on the geophysics plots running north-south along the crest of the hill.
- 5.1.37 Trench 27 contained one ditch (2705) which appears to have been re-cut (2703). Two distinct fills show in plan as well as in section. No finds were recovered from the intervention.
- 5.1.38 Trench 29 (Figure 26) contained Pit 2904 which had burnt stone in its fill (Section 2901). An environmental sample was taken from its primary fill, which appeared to contain charcoal-rich material. Other features in this trench turned out to be furrows and natural fluctuations in the natural.

***Area 4. South-east of Day House (Trenches 22-24, 34-41) Figures 6 and 7.***

- 5.1.39 The majority of this area, with the exception of the south-west corner, was fieldwalked (Section 5.4). The archaeological features in Trenches 22-24 in the northern part of Area 4 were limited to a small scatter of linear features, although all three trenches had prehistoric flint in the topsoil and subsoil. The underlying geology here is Greensand and the topsoil and subsoil were virtually indistinguishable sandy silt.
- 5.1.40 In Trench 22 the removal of 0.2 m of re-deposited sand, (not seen in other trenches) possibly colluvium, from the base, revealed a single narrow linear feature (2206) running north-south. The subsoil underlying this (2202) contained pottery dating to the late Prehistoric period, as well as flint.
- 5.1.41 Trench 23 contained three ditches, one north-south and two east-west. The fill of one (2304) had flint which may date to the late Mesolithic. The fill of another ditch (2309) contained Roman pottery. Trench 24 (Figure 25) contained one slightly deeper ditch just over a metre wide (2404) running east-west. This feature appeared to be running towards a fence line to the east and may well relate to the numerous earthworks preserved in the pasture beyond the fence.
- 5.1.42 In Trenches 34-37, located on a natural geology of Portland sand, only natural features were seen but not recorded in detail. Trench 34, a 100 m long trench, had been located specifically to investigate a circular crop-mark feature suggestive of an early

enclosure. Despite the large amount of flint found on the ploughed surface of the trench and its surrounding area (indicative of a late Mesolithic assemblage, see Section 5.4), no archaeological features were found. An outcrop of pale-yellow and brown sandstone was found in about the middle of trench bedded horizontally and running towards the south-west end of the trench. It is likely that this natural feature is the cause of the cropmark anomaly.

- 5.1.43 Trenches 38 and 40 were empty but a small amount of archaeology was recorded in Trenches 39 and 41, located on more clay-rich soils to the south and east of Area 4. These few features may be a continuation of Roman archaeology to the north-east in Area 2.
- 5.1.44 Trench 39 contained one shallow north-south ditch at the northern end. The ditch fill (3906) had a small fragment of pot dated to the late Iron Age. A large sarsen stone (3904) sitting on the interface between the natural and the subsoil is considered to be naturally occurring or a result of clearance as no pit or cut was detected. A probable tree-throw and plough-scar were also identified in this trench.
- 5.1.45 Trench 41 contained a single linear feature running north-west to south-east (4105). It had two fills with a lot of iron-panning in its upper fill (4103). No finds were recorded but the shape of the cut could be indicative of Roman activity.

***Area 5. North-west of Badbury Wick Farm (Trenches 42-45) Figure 8.***

- 5.1.46 This area was shown to have low archaeological potential. Trench 42 contained a horizon (4203) that may have been a buried soil. It lay beneath a colluvial layer deposited from an easterly direction. No archaeological features were found associated with this level. Bulk soil samples were taken for further analysis but the only plant remains present were modern in date. The deposits below the buried soil were geological. Trenches 44 and 45 contained no archaeological features. Trench 43 contained a single square cut stakehole (4303) of unknown date, but most likely to be modern.

***Area 6. West of Badbury Wick Farm (Trenches 58, 59, 63-68 71-73) Figure 9.***

- 5.1.47 The evaluated area was shown to have only limited archaeological potential. Medieval ridge and furrow was again well preserved here. Furrows were evident in the majority of trenches and other than these, Trenches 58, 59, 64, 65, 66 and 67 were empty. Archaeological investigation within most of the trenches was hampered by the waterlogged ground conditions
- 5.1.48 A possible ditch (6305) at the western end of Trench 63 was the only feature recorded that may not be associated with the ridge and furrow. It was not excavated due to the ground conditions, which also made its orientation difficult to determine. The upper fill of the ditch was clearly cut by a furrow. A single pottery sherd from the surface of the feature was dated to the Roman period.
- 5.1.49 Trench 67 was excavated on waterlogged ground. The only recording that was possible was a sketch plan drawn during machine excavation. This showed linear

features that were most likely to be associated with the ridge and furrow, which was aligned on the same axis.

***Area 7. Badbury Wick Farm and land to the east and south-east (Trenches 48, 49, 50-56, 74-79) Figures 10 and 11.***

- 5.1.50 The evaluation showed the area that immediately surrounded the farm presently occupying the site to have high archaeological potential. All trenches contained archaeological features, except Trench 55, 76, 77 and 78. The features found provided evidence of activity associated with a medieval settlement known to have occupied the site (SMR no. SU18SE452) (JSAC 2003). Other features indicated activity in the area during the late prehistoric period.
- 5.1.51 Trench 48 was positioned over a sub-rectangular earthwork interpreted in the earthwork survey (Corney & Morris 2004) as a platform, probably delineating an individual landholding within the medieval settlement, and a linear feature aligned NW-SE interpreted as a hollow-way giving access to this and other similar platforms.
- 5.1.52 The earliest feature recorded in the trench was a possible broad flat-based ditch or terrace (4808) cut 0.3 m into the natural geology. It was 2.5 m wide with a slightly undulated base and a near vertical side preserved to the north-east. Its fill (4807) contained abundant burnt cereal grain. A bank had been created adjacent to this edge. Large sarsen stones had been placed at the base of the cut, perhaps to form a support or curb below the bank. This bank, which was recorded in the machine excavated section, was 2.8 m wide and 0.4 m in height. It was unclear whether the deposit that filled the cut derived from material eroded from its associated bank or was deliberately filled by the construction of a second bank built on the edge of a ditch that truncated the features western side. A total of 34 pottery sherds retrieved from the deposit were dated to the late 11th century AD. This ditch was one of five NW-SE orientated ditches recorded within the trench. Three of these ditches (unexcavated) lay below the area of the later platform and had silted up prior to its construction. Pottery dated to the late 11th century AD was recovered from the surface of one of these features. A ditch (4814) excavated on the north-east side of the earthwork produced nine sherds of pottery dated to the late 11th century AD. At the south-west end of the trench a ditch (4825) was found that corresponded with the earthwork described as a hollow-way. This feature probably provided drainage and was unlikely to have originated as a hollow-way. Although its function may have changed once the ditch had silted up. No dating evidence was retrieved from its fill.
- 5.1.53 No in situ structures or robbed-out construction cuts were observed during the machine excavation of the earthwork platform, which had been constructed from silty clays. A total of two pottery sherds derived from this material (4809) were dated to the late 12th century AD. A layer of limestone 'rubble' was seen to overlay the earthwork. The resistivity survey (Bunn & Masters 2005) showed an area of high resistance covering a large area along the north-eastern side of the field. This was interpreted in the report as a rubble spread that was continuous across an area immediately north-east of a number of the earthwork platforms. A buried soil had



formed above this rubble layer and indicated that there was some age to the deposit. This soil was in turn overlaid by the present topsoil that may have been imported from elsewhere.

- 5.1.54 Trench 49 was planned and finds collected from the surface of the features and the machine excavated spoil. No excavation was carried out as a result of the ground conditions (see above). A number of features were concentrated in the southern part of the trench and were recorded. Pottery was recovered from the surfaces of two sub-rectangular pits (4903, 4906) at the south-east end of the trench. This material was dated to the late Bronze Age or early Iron Age. The pits were aligned on a north-south axis and may form part of a more extensive alignment.
- 5.1.55 At least five ditches were also recorded. Four of these were aligned NE-SW, with one (4915) changing orientation within the trench. A fifth ditch (4919) was aligned north-south and appeared to terminate at its southern end. Four postholes (4909, 4911, 4913, 4923) and a small number of more ambiguous features, perhaps variations in the natural geology, were also recorded. No finds were retrieved from the surfaces of the ditches and postholes. However, ten sherds of pottery recovered from the machine excavated spoil in the vicinity of these features was dated to the late 11th century AD.
- 5.1.56 Trench 50 contained a single NE-SW aligned ditch (5004) that corresponded to a recorded earthwork (Corney & Morris 2004) interpreted as a hollow-way. Ground conditions prevented the excavation of this feature. However, given the width of the ditch, approximately 1.2 m, drainage, rather than a hollow-way may have been a more appropriate function of this feature. No dating evidence was recovered, although its alignment does respect earthworks interpreted as belonging to the medieval village (*ibid.*).
- 5.1.57 Trench 52 (Figure 27) contained numerous archaeological features. A series of linear pits, perhaps forming part of a discontinuous boundary aligned NE-SW were recorded within the trench. Pottery retrieved from the pits dated to the late 11th century AD. At least six ditches were recorded e.g. (5217, 5219), most of these were investigated (Section 5207). The ditches were aligned north-south with a single example aligned east-west. Some of the ditches probably resulted from episodes of ditch re-cutting. Artefactual evidence suggested a date range between the 11th and 13th centuries AD. All of the pottery dating to the 13th century (42 sherds) was recovered from one ditch fill (5220) which also contained charred cereal grain, wood charcoal and hazelnut shells. A number of postholes were also recorded but not excavated. A large cut feature (4229), perhaps a pond or moat was recorded at the south-western end of the trench. It appeared as though it had been deliberately backfilled. The lower deposit consisted of black clayey silt that contained large boulder sized sub-rounded cobbles. These partially sorted cobbles found throughout the deposits could potentially be the remains of walls or stone structures that have fallen or were most likely dumped into the feature at the time it was silting up. The cut was not fully excavated but auger tests showed that within the trench it attained a depth of approximately 2 m below present ground levels, although the feature may have deepened to the south-west

outside the excavated area. Finds from the upper fill (5230) were dated to the 11th century AD.

- 5.1.58 Trench 53 (Figure 28) contained at least eight linear features, most of which were likely to be ditches. Only two were excavated (5312 and 5316). They were aligned either north-south or NW-SE. A single ditch aligned NE-SW probably related to the medieval ridge and furrow (Section 5303). One of the NW-SE aligned ditches (5312) corresponded with a curvilinear earthwork interpreted in the earthwork survey (*ibid.*) as being a possible hollow-way serving the medieval settlement. However, the three pottery sherds from its lower fill (5314)(not fully excavated) suggested a late prehistoric date for this feature. Two sherds of pottery recovered from the upper fill (5313) were dated to the late 11th century AD. This may indicate that an earlier boundary was reworked during the Saxo-Norman period. The upper fill of this ditch was recut by a gully that contained a single sherd of late 11th century pottery. The earthwork may form part of a much earlier enclosure, possibly related to an earlier phase of settlement in the area. This may have implications for the dating and interpretation of other earthworks in the area. Pottery from the surface of an unexcavated ditch to the south-west of this earthwork was dated to the late 11th century AD.
- 5.1.59 A large sub-rectangular 'scoop-like' cut was recorded in the centre of the trench (5305). Its length was 7.5 m, but its full width was not recorded as it extended outside of the trenched area. It was excavated to a depth of 0.2 m. The base showed a gradual slope towards the centre of the cut, which was left unexcavated. Its edges and base were also very irregular, perhaps indicating a natural origin for the feature. It was not possible to date the pottery recovered from its lower fill. However, pottery from its upper fill was dated to the late 11th century AD. Pottery from a colluvial layer that overlay the archaeology within this trench and was itself sealed beneath the subsoil was dated to the 11th century. Pottery recovered from the machine excavated spoil also dated to the same period, although two sherds dating to the late prehistoric period were recovered from a 10 m stretch of spoil at the south-western end of the trench. This material may have come from a ditch located at this end of the trench that was left unexcavated.
- 5.1.60 Trench 54 was positioned over two linear earthworks interpreted (*ibid.*) as a hollow-way and ditch. No negative feature were seen to correspond with the ditch. However, a negative feature (5404) was associated with the hollow-way earthwork. The cut was approximately 4 m wide, but was not fully excavated because of problems with groundwater within the trench. No associated dating evidence was found with this feature.
- 5.1.61 Numerous pit and ditch-like cuts were planned within the trench. The majority of these were later interpreted as being variations within the natural clays. However, working conditions within the trench were difficult and prevented a more comprehensive investigation of these features. A pit/posthole with charcoal-rich fill (5408) was recorded in plan but was left in situ. A struck flint was recovered from the surface of its fill (5407). This was dated to the later Neolithic or early Bronze Age.

Pottery was also recovered from the machine-excavated spoil adjacent to this feature. The seven sherds recovered were dated to the late prehistoric period.

- 5.1.62 To the east of the farm no significant deposits or archaeological features were seen within Trenches 55 and 56. However, earthworks associated with medieval ridge and furrow were well preserved in the area.
- 5.1.63 Trench 74 (Figure 29) was excavated across a number of earthworks interpreted as being ridge and furrow. A large 'bank like' deposit that shared the same orientation as the ridge and furrow was also recorded at the south-western end of the trench. No structures were found in association with this, which had been constructed, to a height of 0.75 m directly over the natural clays. The topsoil appeared to have been removed prior to its construction. A residual pottery sherd dated to the 2nd century AD was recovered from the platform's makeup layer (7407). A number of negative linear features aligned NW-SE were interpreted as furrows, although a single pottery sherd dating to the late prehistoric period was recovered from one of the ditches (7405). Generally in this area the ridge and furrow left very little impression on the underlying natural. A shallow 'pit-like' feature (7404) was excavated at the north-eastern end of the trench (Section 7400). Two struck flints were recovered from its fills, which also contained a moderate amount of charcoal. These were dated to the later Neolithic or early Bronze Age. An earthwork interpreted as a possible barrow (*ibid.*) was recorded a few meters to the north of this feature.
- 5.1.64 Trench 75 was positioned over a large rectangular platform. A cobbled surface (7503) was recorded at the north-western end of the trench. This may have formed part of a yard or a road aligned on a NE-SW axis. This axis corresponded with the alignment of the earthwork, which had been built up to form a platform at a similar level to the cobbles. The surface had been cut in places by later pitting activity. A pottery sherd from one of these pits (7507) was dated to the 11th century AD. At the south-eastern end of the platform a large ditch (7504) had been cut alongside its edge. It was 6 m wide but was not fully excavated. The small amount of pottery located in the upper fill was dated to late 11th century AD. Tests using an auger showed the ditch base to be flat-bottomed and 2.1 m below the present ground surface. The ditch appeared to be a later addition, cutting the material used in the construction of the platform. However, both features could be contemporary. The relationship observed between earthwork and ditch may be due to an episode of ditch re-cutting. This feature could be interpreted as a hollow-way but could also have been part of a mote or large ditch primarily used to drain water away from the platform. The auger survey also revealed that it was filled by a sequence of silts likely to represent low energy deposits laid down by slow flowing water. The nature of these deposits suggested that drainage was the most likely interpretation for this ditch. On a practical level trackways would probably have been constructed on higher ground and not deliberately cut into the waterlogged natural clays.
- 5.1.65 Trench 76 contained no archaeological features. Ditches within Trenches 77 and 78 were found to be associated with the ridge and furrow. The small amount of archaeological remains uncovered in this area was confined to Trench 79 (Figure 30).

It contained a medieval furrow and curvilinear ditch of unknown date (7907)(Section 7902). A single sherd of Romano-British pottery was recovered from the probable furrow. The curvilinear ditch terminated within the trench and may form part of a small penannular enclosure. A shallow pit-like feature (7905) was also recorded in this trench, but again no dating evidence was found. Generally medieval ridge and furrow was well preserved in the area (7903).

***Area 8. Green Hill (Trenches 80-85, 94) Figure 12.***

- 5.1.66 No archaeological features were recorded in Trenches 80-82 and 94. However, five residual pottery sherds dated to the Roman period were found in the subsoil from Trench 80. Significant archaeological horizons were seen in Trenches 83-85. All the trenches were inundated by ground and rain water. This limited the level of archaeological investigation that could be done in the area. County Archaeologist Roy Canham advised on a less intrusive methodology for recording the archaeology, as excavation would have caused unnecessary damage. A programme of planning and artefact retrieval with a limited amount of excavation was implemented.
- 5.1.67 The number and extent of archaeological features in this area was very difficult to determine, as feature fills were very similar in nature to the natural clays. A layer of possible colluvial clay, again very similar to the natural, covered the base of the trenches. As a consequence Trenches 83-85 required re-machining.
- 5.1.68 Trench 83 (Figure 31) contained 4 ditches (8314, 8213, 8310, 8308). Other more ephemeral features proved difficult to interpret. These may be attributed to natural erosion or bioturbation. Some deposits within less obvious features were only differentiated from the surrounding natural clays by the presence or absence of charcoal flecks. A large linear feature approximately 5 m across and aligned on a NE-SW axis was recorded but not fully excavated. The edges of this ditch (8310) were particularly difficult to find. Its fill contained occasional charcoal flecks but no finds. It had been re-cut twice by less substantial ditches. A total of 29 pottery sherds from the fill (8311) of the latest re-cut were dated to the late Iron Age (Section 8304). This sequence of ditches was possibly associated with, and perhaps enclosing, a probable settlement site located to the south-east (see Trenches 84 and 85). A colluvial layer between 0.1 m and 0.2 m thick sealed the archaeology and was removed during the re-machining of the trench.
- 5.1.69 Following the machine excavation a ditch just over a metre wide (8406) was found towards the middle of the Trench 84 (Figure 32). The fill (8407) contained middle Roman pot and flint (Section 8400). Two further ditches aligned NW-SE, one of which was re-cut (8411), were also recorded following the initial machine excavation (Section 8401). A complete, though not intact, middle Roman vessel was recovered from the re-cut ditch (8412). Wood charcoal was also recovered from a sample processed from this fill. A possible pit (8409) was also recorded (Section 8402). The 21 pottery sherds from its fill were also dated to the middle Roman period.
- 5.1.70 Due to the ground conditions, a second strip was undertaken in Trench 84. The machine excavator removed a further 0.1-0.2 m from the base of the trench. The

nature of this layers formation was not fully understood. Its deposition may have been due to colluvial action but could equally be attributed to disturbance affecting the natural clays. The removal of this layer revealed that the re-cut ditch was in fact re-cutting an earlier and much larger ditch (8418). No finds were recovered from the fill of this earlier ditch, which was only partially excavated. A further pit (not excavated) and a probable burnt treethrow (8414) pit were also recorded.

- 5.1.71 Trench 85 (Figure 33) was also re-machined. Following the original strip a possible ditch (8506) was tentatively identified. (Section 8501) A single struck flint from this feature was dated to the late Neolithic or Bronze Age. The ditch underlay a spread of silt (8503) that contained a high concentration of flint cobbles. This deposit also contained burned wood charcoal, burnt flint and 55 sherds of pottery dated to the late prehistoric period (possibly early Bronze Age).
- 5.1.72 Prehistoric pottery was also recovered from the base of the trench in other areas. In the absence of any clearly defined archaeological features its presence suggested that an undisturbed archaeological horizon probably lay at a deeper level. A 0.1m layer of probable disturbed natural was removed by machine. This revealed a further three ditches or gullies (e.g. 8514), eight pits e.g. (8528) and two postholes (8526 and 8525). Due to ground conditions, these features were not excavated. As a consequence dating evidence was limited to the finds from the excavated ditch and the layer that sealed it. A late Iron Age pottery sherd and another dated to the mid-16th century were recovered from the topsoil.

***Area 9. South-east of Coate Water (Trenches 91-93) Figure 13.***

- 5.1.73 Significant archaeological horizons were recorded in Trenches 91-93. These trenches were positioned over features located during the gradiometer survey (Bunn & Masters 2005). A substantial collection of Bronze Age flint tools and waste flakes, together with pottery had been found here above the 115 m contour (JSAC site 164). This evidence may represent the remains of settlement evidence and the site. Ground water was again a problem in this area, evaluated in late December 2005. Recording was limited to planning and the retrieval of finds from the surface of features, so the depth of the features was therefore difficult to ascertain.
- 5.1.74 Trench 91 (Figure 34) contained three ditches, 9109, 9117, and 9126. Two of them were orientated east-west, the other (9109) was aligned north-south and the widest at 2 m. Ditch 9126 and appeared to terminate within the trench, but the other two of the ditches may have formed part of a penannular enclosure, relating to features detected in the geophysics plots. Seven 'pit-like' features (9105,9107, 9111,9113, 9115, 911,9119, 9121) and a posthole (9103) were also recorded. Some of these 'pits' may be attributed to bioturbation. No finds were recorded from the surface of any of the features in this trench.
- 5.1.75 Trench 92 (Figure 35) contained five ditches (9243, 9239, 9225, 9215, 9208), which were mostly orientated east-west. Ditch 9225 was curvilinear in plan. Pottery from the surface of one of the ditch fills (9209) was dated to the late prehistoric period. Nine possible pits, six postholes and a tree throw pit were also recorded. Pottery from

the surface of pit fill (9242) contained part of a base dated to the late Bronze Age. A total of six unstratified pottery sherds were recovered from the subsoil. These were also dated to the late prehistoric period. Only one of these sherds could be more closely dated to the late Bronze Age or early Iron Age (9th -6th century BC).

- 5.1.76 Trench 93 (Figure 36) contained three pits (9202, 9294, 9227). A large sarsen stone had been placed in one of the pit fills (9306). A width of 2.1 m of the sarsen was visible within the trench. Sherds of pottery and flint were recovered from the surface of the pit (9306) into which the stone had been placed. The flint was dated to the late Neolithic or early Bronze Age and the 11 sherds of pottery were dated to late prehistoric period. A small amount of charred residue was noted on one of the sherds. In addition to this feature, eight possible postholes (9209, 9211, 9213, 9215, 9219, 9221, 9223, 9225), that may have formed part of a structure, were also recorded. Pottery dated to the late 11th century AD was recovered from the surface of one of them. Four NW-SE orientated ditches (9307, 9317, 9329, 9332) were recorded in the trench. No dating evidence was found in association with the ditches. A single pottery sherd dated to the late Iron Age was found in the topsoil.

***Area 10. Adjacent to M4 (Trenches 86-90) (Figure 2).***

- 5.1.77 No archaeological features were found in these trenches. Cropmarks near Trenches 87-88 turned out to be differential natural deposits. Similarly, cropmarks underlying Trenches 88-90 were field drains.

**5.2 *Finds***

*Pottery*

*Prehistoric Pottery By Emily Edwards*

- 5.2.1 A total of 197 sherds (801 g) were recovered from the archaeological evaluation. Further details by context are presented in Appendix 2.
- 5.2.2 The pottery was counted and weighed by context whilst fabric and form were briefly noted (PCRG 1997). Fabrics were given alphanumeric codes relating to the size of the principal inclusion. Generally speaking, in excess of 20 sherds (or several diagnostic sherds) are required from a single prehistoric feature to allow some precision of dating which takes residuality into account. This must be taken into account with the spot dating, especially where there are less than five sherds.

*Middle Bronze Age*

- 5.2.3 The diagnostic element of the assemblage dated to the middle Bronze Age, comprising a crumbly, flint tempered biconical shaped Bucket Urn (1524) and 59 worn sherds of Barrel Urn (1707), which were manufactured from leached shell. Decoration on one sherd from the latter vessel incorporated bold, incised lines bounding lines of deep thumbnail impressions. It is very probable that the sherds from 2006, which were identical in terms of firing and fabric, can be given a similar middle

Bronze Age date, despite their small and abraded character. The base sherds from context 156 comprised two refitting sherds manufactured from a sparse, coarse flint fabric also typical of a middle Bronze Age date. The sherds were all recovered from ditches, some of which contained later prehistoric pottery as well.

- 5.2.4 The interior wall of the biconical shaped Bucket Urn from context 1524 was covered with charred residue. Swindon is c. 22km away from the site at Bishops Cannings Down, part of the Marlborough Downs, from which an important assemblage of Barrel Urn was recovered. The Bucket Urn is a little more unusual in terms of form.

#### *Late Bronze Age*

- 5.2.5 The remainder of the assemblage comprised an apparently homogeneous group. The few diagnostic sherds noted, namely a stepped shoulder, gritted base, two concave neck sherds and three rims, appeared to point to a late Bronze Age date, although this was by no means unequivocal. The shoulder sherd from context 9202 was decorated with an applied piece of clay giving a stepped appearance such as is common on late Bronze Age Biconical Bowls. These are particularly diagnostic vessels. Morris gives a date range of 9-6th century BC for those recovered from Potterne in Wiltshire (Gingell and Morris 2000, 156, figure 47, 11). The neck (4904) sherd may equally be early Iron Age and the two sherds (possibly representing one vessel) from SS2 (8503) may equally be early Bronze Age.
- 5.2.6 This group of later Bronze Age pottery was well fired, several slightly different fabrics having been used in the manufacture. These fabrics appeared to contain flint, glauconitic sand, ironstone and mica, the major inclusions of which would be readily available locally. Despite the small and broken nature of the assemblage (average sherd weight being 3.4 g), the condition of the material was generally good, with some fresh breaks. A small amount of charred residue may have been noted on one sherd from context 9306. It is likely that most of this pottery was recovered from its original context of deposition. The variability of fabrics and wall thickness indicates coarse and fine vessels and potentially represents an assemblage of some variety.

#### *Distribution*

- 5.2.7 Area 1, contained a scheduled upstanding barrow and from Trenches 1 and 3, late prehistoric and middle Bronze Age sherds were recovered (see Appendix 2). Four possible middle Bronze Age sherds were recovered from Trench 30 from Area 2, close to the standing stone circle. Area 3 contained a possible ploughed out barrow and from trenches 15, 17 and 20, located at short distances from each other within the north eastern section of the area, the middle Bronze Age fragments of Biconical shaped Bucket Urn and Barrel Urn were recovered. Area 4 was identified as containing areas of Mesolithic and early Bronze Age flint work during fieldwalking, the latter of which may supported by a possibly early Bronze Age sherd (manufactured from an argillic or grog fabric) which was also recovered during

fieldwalking. Trench 22 from this area contained four sherds of late prehistoric pottery. Area 7 contained earthworks, some of which belong to a possible barrow. Trenches 49, 52, 53, 54 and 74 from this area contained a total of 29 late prehistoric sherds, of which only eleven were identifiable as being of either late Bronze Age or Early Iron Age. The remainder from this area were late prehistoric. Area 8, the area which contains a possible hilltop enclosure, was also identified as an area of prehistoric activity by 29 late prehistoric sherds (one sherd from Trench 82 and 28 sherds from Trench 85). Trenches 92 and 93 within Area 9 contained eighteen late prehistoric sherds (7 from Trench 92 and 11 from Trench 93), two of which were more closely identified as being late Bronze Age (context 9242) and either late Bronze Age or early Iron Age (9202).

### *Discussion*

- 5.2.8 The significance of this assemblage lies in the date of the sherds as it indicates a strong potential for prehistoric settlement in this area. The pottery is all associated with areas where scheduled monuments, newly identified possible monuments or other evidence of prehistoric activity have been noted (see above). Although the assemblage is small and consisting mostly of body sherds, a little further work may be necessary. This may need to include some fabric analysis and research into local parallels, in order to enable a more specific date for the assemblage. Illustration of the Barrel Urn and Bucket Urn should be included. Analysis and radiocarbon dating of the charred residue would provide both an idea of function and a more unequivocal date for the vessel. Furthermore, this material should be considered alongside any pottery recovered from future excavations. It would be advisable to secure the dating for the pottery, as this assemblage may represent a period which is poorly understood in the Swindon area.

### *Late Iron Age, Roman and Post-Roman Pottery By Edward Biddulph*

- 5.2.9 A total of 668 sherds, weighing 8872 g, was recovered from the Phase 2 evaluation (Areas 1- 4) adding to the 148 sherds (1655 g) from Phase 1 (Areas 5-8). The assemblage was rapidly scanned to identify diagnostic forms and fabrics that would allow contexts to be spot-dated and determine its overall character. Fabrics and forms were assigned broad codes from OA's standard recording system, the data being placed on an Excel spreadsheet (available in the archive). However, it should be noted that there is considerable scope for refinement of identification and date on further study.

***Table 1: Pottery by phase***

Period	No. contexts		Weight (g)	
	Phase 1	Phase 2	Phase 1	Phase 2
Late Iron Age	4	36	185	3590
Early	3	8	1442	480



Roman				
Mid Roman	1	1	7	29
Mid-late Roman		3		682
Late Roman		4		1618
Post-medieval	1	3	4	2471
Total	9	55	1638	8872

- 5.2.10 The majority of pottery-yielding contexts (65%) from Phase 2 (Areas 1-4) belonged to the late Iron Age, and so it is unsurprising that most of the pottery in quantitative terms was also of this date. The late Iron Age assemblage was dominated by grog-tempered wares (E80) and flint-tempered wares (E60). Rim sherds were scarce, however, and few forms were recognised; those identified tended to be storage jars (CN) and bead-rimmed jars (CH), though others, such as a fine flint-tempered barrel-shaped jar (CB) or beaker with a cordoned neck in early Roman context 3116, were seen. Sand- and limestone-tempered fabrics (E20/E30 and E50, respectively) were present to a lesser extent, and available as necked, high-shouldered jars (CE) and bead-rimmed jars. The late Iron Age element in the Phase 1 evaluation was proportionately smaller than that for Phase 2, though was consistent in terms of composition.
- 5.2.11 The principal late Iron Age wares continued for a time beyond the Roman conquest - possibly until the end of the 1st century AD - and accompanied most often by fine, medium and coarse sandy grey wares (R10, R30 and R20); the range of forms in these post-conquest fabrics were similar to those available in fabrics of a late Iron Age tradition, and included high-shouldered and bead-rimmed jars. More exotic was Verulamium-region white ware (W21), which arrived after *c* AD 50. Context 512 contained part of a carinated bowl, possibly a *tazza*; the type has traditionally been interpreted as a lampholder or, in a ritual context, an incense-burner (Davies *et al* 1994, 51). In total just eight Phase 2 contexts were assigned to the early Roman period (AD 43-150) on the basis of the pottery; this period was better represented in the Phase 1 evaluation, though, again, the range of pottery from both was broadly identical.
- 5.2.12 A small amount of pottery (7% by weight) provided four contexts with a possible mid Roman date (AD 150-250). This was largely based on the presence of Dorset black-burnished ware (B11). At least one cooking-jar types (CK) and plain-rimmed dish (JB100) was recorded. The use of pottery appears to have increased after AD 250; in terms of pottery weight, the late Roman period was slightly better represented than the late Iron Age, although the majority was residual in post-medieval contexts (it is notable that the Phase 1 evaluation (Trenches 1-39) lacked a late Roman element). Grey wares were abundant as usual; the source for many was probably local, but

North Wiltshire sandy wares are likely to have contributed a significant proportion. Oxfordshire products were also conspicuous, and included white ware mortaria (M22), red- or white-slipped red ware mortaria (M41 and M31), and red colour-coated fine ware (F51). This fine ware was joined by New Forest (F53) and, possibly, Nene Valley (F52) colour-coated wares. Black-burnished ware continued to arrive and now included bead-and-flanged dishes in its repertoire.

- 5.2.13 The amount of post-Roman pottery was small, but there was sufficient to identify much of the late Roman assemblage as residual. A number of glazed, red earthenware sherds dating to the 18th century were recovered from context 3000. One sherd had unusual rouletted decoration, the piece possibly deriving from the Donyatt pottery in Somerset. Context 1403 contained a piece of 19th-century English porcelain.
- 5.2.14 With an average sherd weight of 14 g, the pottery is in good condition, and many large pieces were present. The late Roman component offered some of the best-preserved pottery (fresh surfaces, large sherds, and diagnostic pieces); the late Iron Age assemblage was less useful in these terms, though it was nevertheless coherent with little obvious signs of residuality. Overall, the pottery is likely to have been deposited reasonably close to its original place of use and further fieldwork, if appropriate, is liable to reveal further evidence of late Iron Age and Roman occupation. Ultimately, the pottery from all phases of work should be quantified in detail and further studied to better inform on site chronology, ceramic supply and use.

*Medieval Pottery by Paul Blinkhorn*

- 5.2.15 The pottery assemblage comprised 158 sherds with a total weight of 1,607 g. The estimated vessel equivalent (EVE), by summation of surviving rimsherd circumference was 0.71. It was predominately of earlier medieval date, although a small assemblage of Romano-British material and a single post-medieval sherd were also noted. The Roman material was all abraded to a greater or lesser degree, and appears to either all be redeposited, or was originally deposited in a ploughsoil or the like, and subject to considerable attrition before final deposition. Further details by context are presented in Appendix 2.
- 5.2.16 The medieval and later pottery consisted of the following:

F1: *Ham Green ware*. Pale orange sandy fabric, thicker sherds have a grey core. Late 12<sup>th</sup> – mid 13<sup>th</sup> century (Vince unpub.). 4 sherds, 35 g, EVE = 0.

F2: *Nash Hill ware*. Medieval sandy ware, products of the eponymous kiln site at Lacock, Wiltshire (McCarthy and Brooks 1988, 340). Hard grey and reddish-brown sandy ware, moderate to dense grey and clear sub-rounded quartz up to 1mm, rare calcareous material up to 10mm. Mainly jars, but also green glazed tripod pitchers and slipped jugs. 13<sup>th</sup> – early 14<sup>th</sup> century. 1 sherd, 12 g, EVE = 0.

F200: *Gloucester-type Oolitic ware.*) Brown fabric, quite hard and well-fired with moderate oolitic limestone temper. Vince's Gloucester type TF41B (ibid. 1984), late 11<sup>th</sup> – 12<sup>th</sup> century. 7 sherds, 50 g, EVE = 0.

F202: *Newbury A/B ware:* Late 11<sup>th</sup> – late 14<sup>th</sup> century (Mephram 1997, 51-2). A range of sand-, flint- and limestone-tempered wares. Sparse to moderate limestone up to 2mm, rounded white or clear quartz up to 0.5mm, angular fragments of white, grey or black flint. Jars, bowls and pitchers. 140 sherds, 1,489 g, EVE = 0.71.

F425: *Fine Red Earthenwares:* Mid 16<sup>th</sup> – 19<sup>th</sup> century. Fine sandy earthenware, usually with a brown or green glaze, occurring in a range of utilitarian forms. 1 sherd, 1 g, EVE = 0.

- 5.2.17 The range of medieval fabric types is typical of sites in the region, comprising the products of major manufactories in Wiltshire and Gloucestershire. The bulk of activity appears to date to before the 13<sup>th</sup> century; just one context of that date was noted, with the rest of the post-Roman activity generally spanning the 11th and 12th centuries. The sherds are all generally in good condition and fairly large, indicating that there are well-preserved medieval remains in the vicinity of the excavation.

### *Lithics*

#### *Worked flint and burnt unworked flint and stone by Hugo Lamdin-Whymark*

- 5.2.18 A total of 347 flints and 31/199 g of burnt unworked flint was recovered from the evaluation trenches. The vast majority of the flintwork (249 pieces) was recovered from the topsoil and subsoil in evaluation trenches in Area 4, with comparatively few pieces recovered from archaeological contexts. Fieldwalking in the same area (see section 5.4) recovered a further 1952 flints and 233 piece/553 g of burnt unworked flint. The fieldwalking exercise revealed two discrete scatters. A small scatter in the northern area dated to the late Neolithic/early Bronze Age, whilst the larger southern scatter was of late Mesolithic date. The flintwork from the evaluation trenches dates broadly to the same periods.
- 5.2.19 The evaluation Areas 1, 2, 7, 8 and 9 produced between 2 and 12 flints per area, whilst Area 3 produced a slightly larger assemblage of 66 flints; no flints were recovered from Area 5 and 6. The flintwork in these areas was of a broad later Neolithic or Bronze Age date, based on technological attributes. A few Mesolithic flints were noted in Area 3.

### *Methodology*

5.2.20 The artefacts were catalogued according to broad artefact/debitage type, additional information on condition (rolled, abraded, fresh and degree of cortication), and state of the artefact (burnt, broken, or visibly utilised) was also recorded. Retouched pieces were classified according to standard morphological descriptions (e.g. Bamford 1985, 72-7; Healy 1988, 48-9; Bradley 1999, 211-277). Unworked burnt flint was quantified by weight and number. The assemblage was catalogued directly onto a Microsoft Access database. A printout of the catalogue will be deposited with the archive; where possible a digital copy will be deposited.

#### *Quantification*

5.2.21 A total of 347 flints and 31/199 g of burnt unworked flint was recovered from the evaluation trenches. The flint assemblage from the site by area is shown in Appendix 3.

#### *Provenance*

5.2.22 Flintwork was recovered from 45 contexts, the vast majority of these were topsoil, subsoil or other disturbed layers. In total, only 32 flints were recovered from cut features and the largest number of flints from any context was three pieces; of these some of the flints were clearly residual. No significant groups of flintwork were recovered from features and only two contexts (807 and 1707) contained flints in fresh condition that may be contemporary with the features; neither of these contexts contained diagnostic artefacts to assist in dating.

#### *Raw material and condition*

5.2.23 The raw material exploited for knapping was comparable to the material identified in the fieldwalking assemblage. The raw materials include flint from the chalk region to south and also material derived from a secondary derived source, such as river gravels; further description of the raw material is available in the report on the fieldwalking finds.

5.2.24 The majority of the assemblage was recovered from topsoil and disturbed contexts and was of comparable condition to material recovered from the fieldwalking exercise, exhibiting a variety of post-depositional edge damage. The flintwork recovered from archaeological features was of more variable condition. Some of the flints were clearly residual and of similar condition to material from fieldwalking the topsoil. Two flints, from contexts 807 and 1707 were in particularly fresh condition and may be contemporary with the features, however, the flints are both undiagnostic flakes and do not assist in dating.

5.2.25 The surface condition of the flint was variable, many flints exhibited no surface cortication, whilst others bore either a light or heavy white surface cortication. Occasional iron-stained flints, or spots of iron-staining, were noted.

*The assemblage by area**Areas 1, 2, 7, 8 and 9*

- 5.2.26 These areas produced between 2 and 12 flints, representing a total of 32 flints and 16 pieces/137 g of burnt unworked flint. The assemblage mainly consisted of undiagnostic flakes, with two flake cores (two multi-platformed flake cores and a core on a flake) and three retouched pieces. The retouched pieces were all recovered from Area 1 and comprise two scrapers, including a thumbnail scraper, and a simple edge retouched flake. The flake material was generally struck using hard hammer percussion with little evidence of platform preparation and is most characteristic of later Neolithic and Bronze Age industries. The thumbnail scraper is most probably of a later Neolithic/ early Bronze Age date.

*Area 3*

- 5.2.27 Area 3 produced a total of 66 flints and 10 pieces/68 g of burnt unworked flint. The vast majority of the assemblage (62 flints) was recovered from topsoil in Trenches 17 and 19 (24 and 38 flints respectively). The flint assemblage was dominated by flakes similar to those from the areas above, most characteristic of later Neolithic and Bronze Age industries. A small number of the flakes were of thin and narrow proportions, often exhibiting platform edge abrasion, and a small number of blades were also present. These flints were more characteristic of a blade-based industry and are similar to the flints in the southern scatter of Area 4; they, therefore, most probably date from the later Mesolithic. The retouched assemblage consisted of five scrapers and a single edge retouched flake; these artefacts most probably belong to the later flake-based industry.

*Area 4*

- 5.2.28 A total of 249 flints and 5 pieces/ 32 g of burnt unworked flint was recovered from Area 4. The vast majority of the flintwork was recovered from topsoil and subsoil contexts. Indeed, only six flints were recovered from archaeological features (contexts 2304, 3008 and 3906). A flake in ditch fill 2304 is probably a residual Mesolithic flint and three flakes from ditch fill 3906 can only be broadly assigned to Later Neolithic/Bronze Age. Ditch fill 3008 contained a scraper and a knife, the latter is most characteristic of the later Neolithic/ early Bronze Age.
- 5.2.29 The flintwork from the topsoil and subsoil was comparable to the assemblage of nearly 2000 late Mesolithic and late Neolithic/early Bronze Age flints recovered from fieldwalking in this area (see Section 5.4 for further detail). The composition of the assemblage from evaluation trenching differed from the fieldwalking assemblage and appears to be slightly less representative. Chips and small flakes were far fewer in the evaluation trenches, probably reflecting less favourable conditions for collection, i.e. recently disturbed soil. The absence of small flakes has increased the proportion of retouch in the evaluation trenches to an exceptionally high 10% of the total.

5.2.30 As the general technology of the flint from the topsoil has been described in the fieldwalking report, it will not be duplicated in this report. A few flints from the evaluation trenches are noteworthy. Additional Mesolithic finds include two micro-burins, a burin on a retouched blade and a broken microlith, possibly form 3d, but relatively narrow (Jacobi 1978). Other retouched pieces include 14 scrapers, two of which are thumbnail scrapers of later Neolithic/ early Bronze Age date, piercing tools, a knife and a retouched flake. The assemblage also included a flake core that had briefly been reused as a hammerstone.

### *Conclusions*

5.2.31 The flint assemblage from Swindon Gateway was largely recovered from surface scatters in Area 4, with some from Area 3. The scatters date from the late Mesolithic and late Neolithic/early Bronze Age. It is noteworthy that the evaluation trenches in Area 4 failed to locate archaeological features of these periods, suggesting these sites are perhaps only present in the topsoil and subsoil. Beyond the scatters in Area 4, a small number of flints recovered from archaeological features in Area 1 and 3 may prove to be contemporary with the features from which they were recovered, although currently only a broad late Neolithic or Bronze Age date has been assigned.

### *Ceramic Building Material*

*By Leigh Allen*

5.2.32 A small quantity (1,478g) of ceramic building material was recovered from the evaluation phase of work at Swindon Gateway, the majority of the assemblage (1,122g) is Roman. Identifiable Roman forms include *tegula* used together with *imbrices* for roofing and fragments of *tubuli* (box flue tile) for use in a heating system. The surviving tegula fragments are from the flanges which would have abutted another tegula with a imbrex covering the join to secure the roof against the elements. The box flue tiles would have been attached to the wall and would have allowed warm air to circulate around a room they have combing on their upper surfaces which would have acted as a key for plaster. The Post Roman tile includes a fragment from a plain tile (very thin) that is probably from a roof tile and a slightly thicker fragment that is probably a peg tile with a part of a nail hole surviving in one of the broken edges. No further work is recommended on this assemblage. Descriptions by context are presented in Appendix 5.

### *Animal Bone*

*By Kristopher Poole*

5.2.33 A total of 220 refitted fragments of animal bone, were recovered from this site. Material was recovered from several contexts in total (165, 3000, 5213, 5218, 5220, 5222, 5224, 5314, 8412) and all of the bone studied was hand collected.

- 5.2.34 Bone condition ranged from very good to fair, with the majority exhibiting good preservation. However, this material was highly fragmented, the majority consisting of very fragmentary large-sized mammal long bones, and only 32% of the total bone could be identified to species. Cattle make up most of the identified portion, but their relative importance has been inflated, as all the bones from 165, 5314 and 8412 were highly fragmented cattle teeth. In each of these contexts, these probably only consist of 1-2 teeth at most.
- 5.2.35 *Context 3000*: This contained a section of long bone from a large mammal
- 5.2.36 *Context 5213*: This contained a sheep/goat mandibular right 1st molar, but it was too damaged to assign an age.
- 5.2.37 *Context 5213*: This contained a sheep/goat mandibular right 1st molar, but it was too damaged to assign an age.
- 5.2.38 *Context 5218*: Thirteen large mammal long bones and three medium mammal ribs were recovered.
- 5.2.39 *Context 5220*: By far the largest amount of bone came from this context. Cattle bones consisted of: an axis vertebra, a right unfused distal femur, coming from an animal aged less than 48 months old at death, a right mandible, aged 18-30 months old at death, a fragment of left tibia, and a left fused distal tibia, from an animal at least 30 months old. Sheep/goat was represented by a burnt unfused proximal femur, from an animal less than 42 months old at death, and a right mandible, aged at 12-24 months old at death. Other sheep/goat elements were: a pelvis with a small cutmark on the medio-ventral side, two chop marks on the latero-ventral side, and dog gnawing, as well as two fragments of left tibia, the latter (a fused distal end) from an animal aged at least 20 months old at death. Horse bones were: a tarsal, a fused proximal metatarsal, and a fused proximal radius, which was from an animal at least 12 months old before death. In addition, two articulating duck bones (a right humerus and ulna) were from a bird about the size of a mallard. The rest of the bone consisted of large and medium-sized mammal long bones, vertebrae and skull fragments.
- 5.2.40 *Context 5222*: This context contained sixty-five fragments of large-sized mammal long bones, and one fragment of large-sized mammal vertebra.
- 5.2.41 *Context 5224*: A fragment of cattle metatarsal and a sheep mandibular 2nd molar were recovered, the latter from an animal aged 12-24 months old at death.
- 5.2.42 *Contexts 165, 5314 and 8412*: All elements from these contexts were fragments of cattle teeth, which in each context, probably come from only one to two teeth at most.

### *Discussion*

5.2.43 Based on this very small sample, little can be said of the relative importance of different species to the inhabitants of the site. Cattle, sheep/goat, duck and horse were all animals being exploited, the former for food, and possibly other products, but in Britain from the Roman period onwards, horse generally was not eaten. Although this material was fragmented, the bone condition was mostly good, meaning that further material recovered from the site could potentially reveal more evidence of species exploited, age-at-death and body-part patterns, as well as butchery.

### 5.3 *Palaeo-environmental remains*

*By Seren Griffiths and Dawn Irving*

#### *Methodology*

5.3.1 Fifteen samples were taken as part of the field evaluation. Samples of various sizes were taken from a range of features for the recovery of charred plant remains, molluscs and small bones and artefacts. The charred plant samples were processed by flotation using a modified Siraf-type machine, the flot being collected onto a 250 micron mesh. The remaining material was then wet sieved through a column for the recovery of small bones and artefacts. The flots and residues were air-dried and the flots scanned under a binocular microscope. The residues were sorted for bones and artefacts down to 4mm and the remaining material retained. The details of the environmental remains by context are presented in Appendix 4.

#### *Charred Plant Remains*

5.3.2 Flot sizes ranged from 10-270 ml and the number of charred plant remain items also varied greatly. Cereal grain was present in several of the flots, but was most common in sample 10 (context 4807) and sample 7 (context 5220). Wood charcoal was abundant in three of the samples with a clear dominance of *Quercus* sp. (oak). Other taxa were less common, though Maliodeae (hawthorn type) charcoal was noted in several samples. Sample 14 (context 1707) from the fill of Middle Bronze Age ditch 1705 also contained ash (*Fraxinus*), as did sample 2 from stone spread context 8503. Pomoideae (apple/pear-type) charcoal was present in samples 4 (context 8412) and 7 (context 5220). Charcoal was also abundant in sample 13 (context 2905) though it was frequently covered in mineral concretions and was common in sample 6 (7003).

5.3.3 There was a limited amount of other charred remains present in the flots, with the exception of Sample 10 (context 4807) which contained abundant wheat grains, but the excellent preservation of the charcoal suggests that this was due to the composition of the deposited material rather than a preservation bias. Weed seeds were present in a number of samples, and *Corylus avellana* (hazel) nutshell was present in sample 7 (context 5220). A large number of weed seeds from a range of taxa were present in sample 15 (context 3003), including *Rumex* sp. (dock), *Sambucus niger* (elderberry), and *Polygonum cf persicaria* (knotweed).

#### *Molluscs*



#### 5.3.4 Molluscs were not present in any of the flots

##### *Environmentally recovered sieved finds*

- 5.3.5 Sieved finds most commonly comprised pottery or iron. Items were recovered from a number of samples and were passed to the Finds department for inclusion in the compendium. Of note were the frequencies of burnt clay in sample 14 (context 1707) which included material in which plant impressions were obvious.

##### *Discussion*

- 5.3.6 The samples considered in this assessment were taken to assess the preservation and abundance of environmental and economic indicators from a selection of well-sealed and potentially datable contexts. From the fifteen samples processed and assessed, two offer limited information about the economy and environment at this site and have little potential for further study, while the quantity and condition of charcoal and charred grain in the other samples does justify further study. Should further work be undertaken at this site, these samples should be submitted for consideration by a specialist.
- 5.3.7 It is likely that the charcoal-rich assemblages represent the re-deposited remains of fuelwood. The well-preserved wood charcoal suggests that there is potential for interesting charcoal/charred plant assemblages at the site. Since the sampled prehistoric features were almost all ditch fills rather than deposits directly associated with human occupation the scarcity of cereal grains and other food items is unsurprising. If future excavations were to consider pits and surfaces directly associated with occupation, a richer plant assemblage could be expected.

#### 5.4 ***Results from Fieldwalking and Finds***

##### *Lithics and burnt flint by Hugo Lamdin-Whymark*

- 5.4.1 A total of 1952 flints and 233 pieces/553 g of burnt unworked flint was recovered field-walking over the proposed development area (Area 4). The fieldwalking identified two distinct scatters of flintwork and a general background scatter (Figure 38 and 39). Technological attributes and typologically distinct artefacts suggest the northern cluster dates from the later Neolithic/early Bronze Age (Beaker period), whilst the southern cluster is of late Mesolithic date. In addition to the flintwork from the distinct clusters, a small number of earlier Mesolithic flints may be present, but this could not be confirmed with typologically diagnostic artefacts; a later Neolithic oblique arrowhead was also found.

- 5.4.2 A further 347 flints and 31/199 g of burnt unworked flint was recovered from evaluation trenching (see evaluation trenching report for further detail); the majority recovered from topsoil in the area of the flint scatters.

#### *Methodology*

- 5.4.3 The artefacts were catalogued according to broad artefact/debitage type, additional information on condition (rolled, abraded, fresh and degree of cortication) and state of the artefact (burnt, broken, or visibly utilised) was also recorded. Retouched pieces were classified according to standard morphological descriptions (e.g. Bamford 1985, 72-7; Healy 1988, 48-9; Bradley 1999, 211-277). Unworked burnt flint was quantified by weight and number. The assemblage was catalogued directly onto a Microsoft Access database. A printout of the catalogue will be deposited with the archive; where possible a digital copy will be deposited.

#### *Quantification*

- 5.4.4 A total of 1952 flints and 233 pieces/553 g of burnt unworked flint was recovered fieldwalking over the evaluation area. The flint assemblage from the site is shown in Appendix 3.

#### *Provenance*

- 5.4.5 The flint assemblage was recovered from transects across the ploughed topsoil spaced at 20 m, representing collection from 10% of the fields surface area. The collection recovered a large number of chips (<10 mm<sup>2</sup>) and small flakes, reflecting favourable geological conditions, a well weathered surface and skills of experienced field-walkers. It is therefore likely that smaller items, such as micro-burins and microliths, which are not usually recovered in any quantity, are well represented.

#### *Raw material and condition*

- 5.4.6 The raw material utilised differs between the southern and northern scatters. The flint in the southern scatter often exhibited an unabraded beige cortex, between 5 mm and 10 mm thick and where freshly broken the flint was dark brown to black. A possible source for this flint is the chalk region to the south. The northern scatter generally appeared to exploit small pebbles of flint with abraded cortexes of various colours and numerous thermal fractures. This flint is typical of material from a water-derived source, such as river gravels. A flake of possible dark grey/black chert was found in transect 1520; the raw material is similar to Portland chert.

***Table 2: The flint assemblage from field walking at Swindon Gateway***

CATEGORY TYPE	Area		Grand Total
	Area A (Squares 1-10)	Area B (Squares 11-29)	

Flake	189	971	1160
Blade	7	58	65
Bladelet	3	52	55
Blade-like	6	64	70
Irregular waste	13	44	57
Chip	71	326	397
Micro-burin		28	28
Rejuvenation flake core face/edge		9	9
Rejuvenation flake tablet	1	10	11
Rejuvenation flake other		10	10
Janus flake (thinning flake)		1	1
Core single platform blade core		2	2
Other blade core	1	1	2
Tested nodule/bashed lump	1	5	6
Single platform flake core	1	5	6
Multiplatform flake core	3	10	13
Core on a flake		1	1
Unclassifiable/fragmentary core		2	2
Microlith		9	9
Oblique arrowhead		1	1
Barbed and tanged arrowhead	1	1	2
Unfinished arrowhead/blank	1		1
End scraper	1	3	4
End and side scraper		1	1
Disc scraper	1	1	2
Thumbnail scraper	2	1	3
Other scraper		6	6
Awl	1	1	2
Denticulate		1	1
Notch	1	2	3
Retouched flake	3	15	18
Misc. retouch		1	1
Burin	1		1
Axe sharpening flake		2	2
Grand Total	308	1644	1952

Burnt unworked flint (no./g)	133/249	100/304	233/553
No. burnt (%)*	29 (12.2)	123 (9.3)	152 (9.8)

No. broken (%)*	70 (29.5)	532 (40.4)	602 (38.7)
No. retouched (%)*	12 (5.1)	43 (3.3)	55 (3.5)
No of flakes per core	34	44	42

\*Percentage excludes chips

5.4.7 The condition of the flint assemblage was relatively fresh, but exhibited damage typical of material from fieldwalking. A large number of flints exhibited post-depositional breaks, identified by differing levels of white surface cortication or freshly broken surfaces. A number asymmetric notches typical of plough damage were also present (Moss 1983).

5.4.8 The surface condition of the flintwork from fieldwalking exhibited considerable variation. The northern cluster (Area A) was generally not corticated or exhibited only the lightest white cortication, whilst the southern cluster mostly exhibited a heavy white cortication with smaller numbers exhibiting a light white cortication. A small number of exceptionally heavily corticated and rolled flints were also identified that may predate the majority of flintwork and perhaps date from the early Mesolithic, but it was not possible to verify this date with typologically diagnostic artefacts. To some degree this differentiation is chronological as well as spatial, with heavier white cortication on Mesolithic flints, however, cortication is notoriously unreliable as a dating tool and more significance is given to the spatial distribution. Orange iron-staining and spots were observed on a small number of flints.

#### *The assemblage*

5.4.9 The assemblage will be considered as two areas, relating to the two distinct scatters. Area A consists of squares 1-10 including the northern scatter, whilst Area B consists of squares 11-29 including the southern scatter.

#### *Area A □ the northern scatter*

5.4.10 The northern area contains a small assemblage of 308 flints, of which the majority were contained in a scatter measuring *c* 125 m diameter. The flint assemblage is largely composed of small irregular flakes. These flakes appear to be the product of a flake-based industry with no evidence for intentional blade production. The flints in the assemblage indicate relatively little control was exercised in core reduction; the edges of cores were rarely abraded prior to the detachment of flakes and most of the flake cores are irregular indicating poorly co-ordinated reduction. Retouched artefacts represent a relatively high 5.1% of the assemblage and included a barbed and tanged arrowhead (Sutton type C, Green 1980), an unfinished arrowhead, four scrapers (including two thumbnail forms), three edge-retouched flakes, a notch, an awl and a burin. The unfinished arrowhead is broken and of indeterminate form.

5.4.11 The barbed and tanged arrowhead, thumbnail scrapers and general reduction techniques are characteristic of late Neolithic and early Bronze Age (Beaker)

industries. A very small number of the flints in the assemblage, including the burin and blade core, belong with the late Mesolithic industry discussed below. A further barbed and tanged arrowhead was found just to the south in Area B.

*Area B □ the southern scatter*

- 5.4.12 The southern area includes a high density scatter over 200 m across, with a lower density scatter to the south-east. Reduction techniques in the southern area differ significantly from the northern area, with a tendency towards blade and bladelet production (the majority not exceeding 40 mm). The majority of the flakes appear to result from careful reduction, with most flakes and cores exhibiting platform-edge abrasion. Moreover, care has been taken to adjust the form of the core during knapping, as demonstrated by the large number of platform rejuvenation tablets and core/face rejuvenation flakes. Blades, bladelets and blade-like flakes form 15.2% of the flake assemblage in the southern Area B, compared to 7.8% in the northern Area A. This proportion of blades is relatively low in comparison to other Mesolithic assemblages, which usually contain in excess of 30% blades (see Ford 1987), perhaps reflecting the large number of small flakes recovered.
- 5.4.13 The flakes recovered include many non-cortical and side trimming flakes, but comparatively few cortical flakes. This may suggest the importing of partially worked or prepared nodules to the site. The cores include a variety of blade and flake forms, including single and multiple platforms. The majority of the cores were carefully worked until exhausted and a number of the flake cores appear to have originally been blades core, only used for flake production late in their working.
- 5.4.14 Retouched tools represented 3.3% of the total assemblage. Microliths were the most common tool with nine examples identified. Four microliths were complete and identifiable, two were scalene micro-triangles (form 7a<sup>2</sup>, Jacobi 1978) and the other two were micro-lunates (form 9, Jacobi 1978); the five broken microliths include a further two possible micro-triangles, two rod forms and unidentifiable form. The scalene micro-triangles and rods provide a later Mesolithic date, but the presence of micro-lunates, a specialised geometric form, suggest a post 5000 BC date for the assemblage (Ibid. 19). Evidence for microlith production was also demonstrated by the presence of 28 micro-burins.
- 5.4.15 Other retouched artefacts include 12 scrapers, 1 awl, 1 denticulate, 2 notches, 15 flakes with simple edge retouch and two arrowheads. In addition, two tranchet axe sharpening flakes were recovered, indicating the presence and use of these tools although they do not appear to have been manufactured on site. The arrowheads include a barbed and tanged form (Sutton type C, Green 1980), recovered close to the Beaker scatter in Area A, and a British oblique form recovered from the south east of the site. The latter arrowhead dates from the later Neolithic and is commonly associated with Grooved Ware and henge monuments; recent excavation of a midden at the eastern entrance of the Durrington Walls henge recovered over 150 arrowheads

of this form. A few further probable late Neolithic/early Bronze Age flints were also identified in the southern area, including a thumbnail scraper; these represent general background finds peripheral to the main Beaker scatter to the north (Figure 39).

- 5.4.16 In addition, in the southern scatter a few rolled and heavily white corticated flints are tentatively dated to the earlier Mesolithic on the basis of broad technological traits (i.e. broader blade production). It was, however, not possible to clarify this date with typologically distinct artefacts.

### *Conclusions*

- 5.4.17 Fieldwalking has revealed two distinctive scatters, one of late Mesolithic date and the other of Beaker date. The late Mesolithic scatter most probably results from the repeated re-visiting of the location on numerous occasions and represents one of the largest surface scatters known in the region (see Holgate 1988). Raw materials appear to have been imported to site (probably from a chalk region) for the maintenance of toolkits, primarily consisting of microliths and scrapers. The Mesolithic scatter may represent an extension of a Mesolithic scatter previously identified in Coate Water immediately west of the site (JSAC 2003 site 156).
- 5.4.18 The absence of Neolithic flintwork from the proposed area, with the exception of the Oblique arrowhead, is noteworthy given the proximity of the site to possible Neolithic monuments. Neolithic flintwork has also been recovered from Coate Water to the west of the site.
- 5.4.19 The late Neolithic/early Bronze Age (Beaker) scatter is considerably smaller than the Mesolithic scatter and appears to result from the working small derived flint nodules, probably from a gravel source. The range of retouched tools and relatively high proportion of retouch suggest a good range of activities, but these are difficult to characterise given the limited scale of the assemblage. Further Bronze Age flints were found to the west (JSAC 2003 site 164).
- 5.4.20 The proximity of the scatters to Coate Stone Circle at Day House Farm, c 200 m to the east, is of particular significance. The later Neolithic/ early Bronze Age scatter is likely to be contemporary with the construction and/or use of the monument. The tasks performed at this location, or manner in which they were performed, may be reflected in the composition of the flint assemblage, but due to the limited number of finds recovered from the evaluation it is not possible to explore this issue at present. The presence of a significant late Mesolithic scatter may also have had a bearing on the location of the later activity and monument as Neolithic monuments frequently reference the sites of earlier activity. For example, many Neolithic Cotswold-Severn tombs reference middens and scatters that predate the structures (for example Hazleton North (Saville 1990), Ascott-under-Wychwood (Benson and Whittle Forthcoming) and Gwernvale (Brittnell 1984)). Moreover, the avenue at Avebury

appears to intentionally incorporate a Neolithic surface scatter into its course (J Pollard pers. comm.).

5.4.21 It is particularly noteworthy that both of these periods are rarely represented by sub-surface archaeology; features were rarely cut in the Mesolithic and material was only occasionally deposited in tree-throw holes, whilst by the Beaker period the pit digging tradition of Neolithic had largely declined (authors data and see Thomas 1999, Chapter 4). This point was further borne out by the negative results from the evaluation trenches in this area. The vast majority of our understanding of settlement patterns in these periods derives from the interpretation of surface scatters.

### *Pottery*

*By Emily Edwards and Dr Edward Biddulph.*

5.4.22 A total of 14 sherds (72 g) were recovered from fieldwalking (Figure 41). One sherd was observed to be part of a carinated bowl but the remaining sherds were all plain, abraded body sherds. The flint and sand fabrics were generally prehistoric in date but no diagnostic sherds were present. It is likely that the prehistoric sherds are later Bronze Age to early Iron Age in date, a suggestion which can be supported by the quartz and glauconitic sand present in some of the fabrics.

**Table 3: Fieldwalking Pottery**

Context	Count	Weight	Date	Comment
100523	1	3	Prehistoric	Sparse coarse flint
100603	1	2	RO	Fine grey ware
100605	1	2	Prehistoric	Sparse coarse flint and sand
100607	1	2	Indeterminate	Sand
100624	2	10	Prehistoric	Sand and sparse flint and greensand
100625	1	8	Prehistoric	Sand and moderate flint
100901	2	2	Prehistoric	Fine flint
1001507	1	13	LIA/ERO (up to AD 100)	Grog tempered
1001519	1	4	Prehistoric	Argillic fabric containing sparse flint
1001601	1	6	M/LIA	Flint tempered
1001922	1	7	IA	Flint and common glauconite
1002701	1	13	LIA/ERO	Grog and sand , carinated bowl
	14	72		

## 6 DISCUSSION AND INTERPRETATION

### 6.1 *Reliability of field investigation*

- 6.1.1 The extremely wet ground conditions during the evaluation, especially in December and February, did have a limiting effect on our understanding of the evidence from the trenching. In areas where there was flooding and a density of features, only very limited interventions were made, following advice from the County Archaeologist. As a consequence, only a broad interpretation of the nature and significance of the archaeological remains can be made at this stage of the evaluation. The three areas where no or little evidence was found may be a genuine reflection of the absence of remains or a result of the relatively small sample of the area covered (0.5%) and distances between trenches.
- 6.1.2 However, 315 features have been recorded, of which 128 can be dated by pottery, giving a broad impression of the nature and intensity of use of the various areas of this landscape through time.
- 6.1.3 The methodology used for the fieldwalking survey in Area 4 (transects at 20 m intervals) initially seemed quite crude for detecting evidence of early activity. However, many small pieces of flint were retrieved, such as microliths, which is testament to the good ground conditions and visibility, and the skill of the fieldwalkers.

### 6.2 *Overall interpretation*

- 6.2.1 The evaluation has been undertaken in an area already identified as having high archaeological potential. Thus, the fieldwork has helped to identify and define areas of known archaeological features, as well as discovering previously unknown ones. The evaluation located several areas of good survival of archaeological features, namely areas 1-4, and 7-9. Areas 5, 6, and 10 contained no or very limited features.
- 6.2.2 During the evaluation the earliest evidence of activity in the area came from the fieldwalking survey in Area 4. Within this 20-hectare field, two concentrations of lithic material were detected, dating to the late Mesolithic and early Bronze Age (Beaker period). Both are well-defined and well-dated scatters of material, probably representing repeated episodes of activity here in an area, which may have been attractive because of its geology (located on Portland sand with outcrops of sandstone). The presence of Beaker period activity is no surprise in this area, less than 200 m from the Coate Stone Circle. The Mesolithic presence is more unusual and the scatter represents one of the most extensive in the region. The relationship between the artefacts in the topsoil and any sub-surface features in this area is uncertain. This may be a reflection of the difficulty of detecting discrete groups of early prehistoric features with widely-spaced trenches, or that there were no contemporary structural activities.
- 6.2.3 Lithic material from the topsoil of trenches in Area 3 display traits of late Mesolithic and early Bronze Age activity. Evidence of middle Bronze Age activity has been



found in the form of pottery from three trenches here. A further trench in the same vicinity (Trench 19) contained two steep-sided ditches set around 25 m apart which corresponds to an enclosure on the geophysics plots. This is a well-defined ring ditch, interpreted as a barrow (Bunn and Masters 2005, page 12). However, there is a difficulty with the correlation of the geophysics plots and the features in the evaluation trenches in this area, probably relating to a mismatch with the original plotting on OS map base data (Roy Canham pers comm). There is clearly at least one barrow in this field which appears from the dating evidence to be an area of earlier and later prehistoric activity rather than Roman and Medieval. This may relate to the recent discovery of Bronze Age pits and deposits nearby under line of the A419 (Roy Canham pers comm).

- 6.2.4 A further area with prehistoric activity was located at the eastern side of the proposed development area adjacent to the south-eastern bank of Coate Water, in Area 9. In this area the findings of the evaluation correlated well with the substantial spread of Bronze Age flint and pottery collected from the area previously (SMR no. SU18SE164) (JSAC 2003). The three trenches were located in relation to features indicated by previous geophysical survey. However, it is difficult to relate the negative features in the trenches precisely to the results of the geophysics. Prehistoric finds and features (ditches, pits and postholes) dating to the Bronze Age were located. Again the nature of this activity was difficult to determine, although the evidence suggested some sort of settlement activity in this location (in particular the possible alignment of postholes in Trench 93. A large sarsen stone deliberately buried in a pit indicated a possible element of ritual activity.
- 6.2.5 In the north part of Area 1, the low earthworks visible in the pasture hinted at the potential of the area for prehistoric remains, close to extant burial mound. It had been subject to detailed analytic earthwork survey (Corney and Morris, 2005) and the evaluation trenches were located in respect to some of these features. The survey had identified five low mounds (including the scheduled barrow), a series of scarps and features relating to agricultural activities. The trenches in the northern part of the field were dense with ditches, pits and the remains of probable structures and settlement evidence. Although not many of these were investigated, they are mostly dated to the late Iron Age. Mound 17, interpreted as a probably barrow in the earthwork survey, possibly correlates with ditches in Trench 2, and a fragment of middle Bronze Age pottery were recovered from a feature in Trench 1. The plot from the geophysical survey in this area also is indicative of an earlier landscape.
- 6.2.6 Further evidence of prehistoric activity was found to the south of Badbury Wick Farm on Green Hill, Area 8. Here finds and features dating from possibly the early Bronze Age to the late Iron Age/early Roman periods were revealed. These features may indicate settlement activity on the hill. A large ditch (not fully excavated) suggested that this settlement might have been enclosed or defended. The contexts from which the early Bronze Age artefacts were retrieved was not fully understood.
- 6.2.7 The focus of Roman activity in the area appears to have been in the southern part of Area 2, opposite Day House. The four evaluation trenches here, placed in relation to

features plotted from geophysical survey, revealed evidence of occupation levels and structural features dating from early, middle and late Roman period. The finding of pieces of box flu tile and other Roman CBM indicates the presence of a building in this field. This correlates with the geophysical survey plots of rectangular features between Trenches 30, 31 and 32. The evidence of this Roman activity does not appear to extend much further west, into Area 6, or much beyond the top part of this field. It is likely to represent the remains of a relatively small Roman farmstead.

- 6.2.8 Medieval features associated with the known shrunken medieval village at Badbury Wick Farm were uncovered in Area 7. Historically, the settlement is first mentioned in 1425 (Gover 1939). This evaluation has shown the settlement to be of a predominately earlier medieval date, with most activity occurring in the 11th century AD. In addition to the medieval archaeology, finds and features dating to the Bronze Age and Iron Age indicated prehistoric activity in the area, though it was difficult to determine the nature of this activity.

## APPENDIX 1 ARCHAEOLOGICAL CONTEXT INVENTORY

<i>Trench</i>	<i>Arch. Features?</i>	<i>Avg trench depth (m)</i>	<i>Context No.</i>	<i>Type</i>	<i>Width (m)</i>	<i>Thick/ depth (m)</i>	<i>Comment</i>	<i>Finds</i>	<i>Date</i>
001	Yes	0.5	100	Layer	-	0.30	Topsoil		
			101	Layer		0.20	Subsoil		
			102	Layer	-	-	Natural/ Sandy clay		
			103	Cut	0.90	0.16	Ditch		
			104	Deposit	0.90	0.16	Fill of ditch	Pot	ER
			105	Cut	1.90	0.60	Curvilinear ditch		
			107	Cut			Ditch		
			108	Deposit			Fill of ditch		
			109	Cut	0.20		Circular feature		
			110	Deposit	0.20		Fill of circular feature		
			111	Cut	0.65		Semi-circular feature		
			112	Deposit			Fill of semi-circular	Pot	LPREH
			113	Cut			Sub circular feature		
			114	Deposit			Fill of sub circular		
			115	Cut	1.6		Ditch		
			116	Deposit	1.6		Fill of ditch		
			117	Cut	1.2		Ditch		
			118	Deposit	1.2		Fill of ditch		LIA
			119	Cut			Semi-circular feature		
			120	Deposit			Fill of semi circular		
			121	Cut			Sub circular		
			122	Deposit			Fill of sub circular		
			123	Cut			Circular feature		
			124	Deposit			Fill of circular feature	Pot	LIA
			125	Cut			Rectangular feature		
			126	Deposit			Fill of rectangular		
			127	Cut	0.65		Ditch		
			128	Deposit	0.65		Fill of ditch	Pot	LIA
			129	Cut			U-shaped feature	Pot	
			130	Deposit		0.06	Fill of U-shape	Pot	LIA
			131	Cut			Ditch		

			132	Deposit			Fill of ditch		
			133	Cut	0.75		Ditch		
			134	Deposit	0.75		Fill of ditch	Flint	
			135	Cut	0.70		Ditch		
			136	Deposit	0.70		Fill of ditch		
			137	Cut	0.65		Ditch		
			138	Deposit	0.65		Fill of ditch		
			139	Cut	0.35		Circular feature		
			140	Deposit	0.35		Fill of circular		
			141	Cut	1.65		Ditch		
			142	Deposit	1.65		Fill of ditch	Pot	LIA
			143	Cut			Sub circular feature		
			144	Deposit			Fill of sub circular		
			145	Cut	0.95		Semi-circular feature		
			146	Deposit	0.95		Fill of semi-circular	Pot	LIA
			147	Cut			Amorphous shape		
			148	Deposit			Fill of amorphous		
			149	Cut	0.95		Rectangular feature		
			150	Deposit	0.95		Fill of rectangular	Pot	LIA
			151	Cut	0.60		Semi-circular feature		
			152	Deposit	0.60		Fill of semi-circular		
			153	Cut			Ditch		
			154	Deposit			Fill of ditch		
			155	Cut	0.50	0.25	Ditch/Gully		
			156	Deposit	0.50	0.25	Fill of ditch	Pot	LPREH/ MBA
			157	Cut	0.95		Oval feature		
			158	Deposit	0.95		Fill of oval		
			159	Cut	0.33	0.06	Pit		
			160	Deposit		0.06	Fill of pit		
			161	Cut			Ditch/gully	Pot	
			162	Deposit			Fill of ditch/gully	Pot	LIA
			163	Deposit	0.18	2.20	Tertiary fill of ditch 105	Pot	LIA
			164	Deposit	0.16	1.60	Secondary fill of ditch 105	Pot, bone	LIA
			165	Deposit	0.24	1.05	Fill of 105	Pot, bone,	LIA

								burnt stone	
			166	Deposit	0.06	0.25	Fill if 105		
			167	Deposit	0.24	0.80	Fill of 105		
			168	Deposit	0.20	1.10	Fill of 105	Pot, flint	LIA
			169	Deposit	0.25	1.50	Fill of 105		
			170	Deposit	0.10	0.50	Fill of 105		
			171	Deposit	0.10	0.90	Fill of 105		
			172	Layer	0.08	0.50	Bank, upcast spoil		
			173	Layer	0.30	0.95	Bank, upcast spoil		
002	Yes	0.3							
			200	Layer	0.20	-	Topsoil		
			201	Layer	0.15	-	Subsoil	Pot	LIA
			202	Layer	-	-	Natural		
			203	Cut					
			204	Deposit			Fill		
			205	Cut					
			206	Deposit			Fill		
			207	Cut					
			208	Deposit			Fill		
			209	Cut	4.5	0.50	Ditch		
			210	Deposit	4.5	0.25	Fill	Pot, flint	
			211	Deposit	3	0.30	Fill	Pot	LIA
			212	Cut	0.70	0.30	Ditch		
			213	Deposit	0.30	0.70	Fill	Pot, flint	LIA
			214	Cut			Pit		
			215	Deposit			Fill of pit		
			216	Cut			Pit		
			217	Deposit			Fill of pit		
			218	Cut			Pit/posthole		
			219	Deposit			Fill of pit		
			220	Deposit			Fill of 237		
			221	Cut			Posthole		
			222	Deposit			Fill of posthole		
			223	Cut	0.50		Pit/bioturbation		
			224	Deposit	0.50	0.20	Fill of pit		

			225	Cut	3.00	0.45	Ditch		
			226	Deposit	3.00	0.45	Ditch fill	Pot	LIA
			227	Cut			Pit		
			228	Deposit			Fill of pit		
			229	Cut			Bioturbation		
			230	Deposit			Pit		
			231	Cut			Gully		
			232	Deposit			Fill of gully		
			233	Cut			Posthole		
			234	Deposit			Fill of posthole		
			235	Cut			Ditch?		
			236	Deposit			Fill		
			237	Cut			Pit		
			238	Object	0.70		Sarsen boulder		
			239	Cut	0.10	0.10	Pit for sarsen		
			240	Deposit		0.10	Fill of pit		
			241	Deposit	0.98	0.32	Fill of 246	Pot, flint	LIA
			242	Deposit	0.65	0.30	Fill of 246	Pot, flint	LIA
			243	Deposit	0.60	0.50	Fill of 246	Pot	
			244	Deposit	0.40	0.60	Fill of 246		
			245	Deposit	0.50	0.20	Fill of 246		
			246	Cut	0.98	0.46	Ditch		
			247	Deposit	0.75	0.18	Fill of ditch	Pot	LIA
			248	Deposit	0.65	0.28	Fill of ditch	Pot, flint	LIA
			249	Deposit	0.55	0.40	Fill of ditch		
			250	Cut	0.75	0.48	Ditch		
			251	Cut	0.60	0.18	Posthole		
			252	Deposit	0.60	0.18	Fill of posthole		
			253	Cut	0.40	0.44	Pit		
			254	Deposit	0.40	0.44	Fill of pit		
003	Yes	0.45							
			301	Layer			Topsoil		
			302	Layer			Subsoil		
			303	Cut	0.75	0.5	Ditch		
			304	Deposit		0.5	Fill of ditch	Pot	Rom

			305	Deposit	1.46	0.20	Fill of ditch	Pot	LPREH
			306	Cut	1.46	0.20	Ditch		
			307	Deposit	1.00	0.11	Fill of ditch		
			308	Cut	1.00		Ditch		
			309	Deposit	1.00	0.10	Fill of tree throw		
			310	Cut	0.10		Tree throw/bioturbation		
			311	Layer	-	-	Natural: Silty clay		
004	Yes	0.3							
			400	Layer	-	0.18	Topsoil		
			401	Layer	-	0.12	Subsoil	Pot	Rom
			402	Deposit	0.84	0.10	Fill of terminal	Pot	ER
			403	Cut	0.84	0.10	Ditch terminal		
			404	Deposit	0.55	0.10	Fill of ditch	Pot	LIA
			405	Cut	0.55	0.10	Ditch		
			406	Layer	0.60	0.10	Buried soil	Pot	ER
			407	Deposit	0.60	0.02	Fill of bioturbation	Pot	LIA
			408	Cut	0.5	0.10	Bioturbation		
			409	Cut	2.62	0.53	Ditch terminal		
			410	Deposit	0.81	0.18	Fill of terminal		
			411	Deposit	0.25	0.48	Fill of terminal	Pot	LIA
			412	Cut	0.43	0.30	Gully		
			413	Deposit	2.10	0.30	Fill of gully		
			414	Cut	0.85	0.42	Ditch		
			415	Deposit	2.25	0.42	Fill of ditch	Pot	LIA
			416	Cut	1.04	0.18	Ditch		
			417	Deposit	1.04	0.18	Fill of ditch	Pot	Rom
			418	Cut	1.12	0.20	Furrow		
			419	Deposit	1.12	0.20	Fill of furrow		
			420	Cut	2.20	0.68	Ditch		
			421	Deposit	0.66	0.20	Fill of ditch		
			422	Deposit	2.20	0.44	Fill of ditch		
005	Yes	0.35							
			500	Layer		0.13	Topsoil		
			501	Layer		0.22	Subsoil		
			502	Layer	-	-	Natural Clay		

			503	Cut	1.30	0.21	Pit		
			504	Deposit	1.30	0.21	Fill of pit		
			505	Cut	1.76	0.44	Ditch terminal		
			506	Deposit	1.76	0.44	Fill of ditch terminal	Pot, flint	LIA
			507	Cut	1.10	0.44	Pit		
			508	Deposit		0.19	Fill of pit		
			509	Deposit		0.20	Fill of pit		
			510	Deposit		0.05	Fill of pit		
			511	Cut			Ditch		
			512	Deposit		0.15	Fill of ditch	Pot	ER
			513	Cut	1.00	0.30	Ditch		
			514	Deposit	0.35	0.50	Fill of ditch		
			515	Deposit	0.75	0.05	Fill of ditch		
			516	Cut	0.30	0.16	Gully		
			517	Deposit	0.30	0.16	Fill of gully		
006	Yes	0.5							
			600	Layer	-	0.20	Topsoil		
			601	Layer	-	0.30	Subsoil		
			602	Layer	-	-	Natural Clay		
			603	Cut	0.80	0.30	Ditch		
			604	Cut	0.80	0.30	Ditch	Pot	LIA
			605	Deposit	0.80	0.30	Fill of 603	Pot	
			606	Deposit	0.80	0.30	Fill of 604		
			607	Cut	0.30	0.15	Gully		
			608	Deposit	0.30	0.15	Fill of gully		
			609	Cut	0.40	0.27	Gully		
			610	Deposit	0.40	0.27	Fill of gully	Pot	LIA
			611	Cut	0.46	0.20	Gully/ditch		
			612	Deposit	0.46	0.20	Fill of gully ditch	Pot	ER
			613	Cut	1.60	0.24	Hedgeline		
			614	Deposit	1.60	0.24	Fill of hedgeline	Pot	LIA
			615	Cut	0.60	0.08	Gully		
			616	Deposit	0.60	0.08	Fill of gully		
			617	Cut	0.36	0.14	Gully		
			618	Deposit	0.36	0.14	Fill of gully		



			619	Cut	1.30	0.44	Ditch		
			620	Deposit	1.20	0.32	Fill of ditch	Pot	LIA
			621	Deposit	1.24	0.10	Fill of ditch		
007	Yes	0.5							
			700	Layer	-	0.15	Topsoil		
			701	Layer	-	0.30	Subsoil		
			702	Deposit	0.95	0.38	Fill of ditch		
			703	Cut	0.95	0.38	Ditch		
			704	Deposit		0.34	Fill of ditch		
			705	Cut			Ditch		
			706	Deposit		0.18	Fill of pit/terminal		
			707	Cut		0.18	Pit/terminal		
			708	Layer	-	-	Natural: Silty clay		
008	Yes	0.6	801	Layer	-		Topsoil		
			802	Layer			Subsoil		
			803	Deposit	0.16	0.08	Fill of ditch/terminus	Pot	LIA
			804	Cut	0.16	0.08	Ditch/terminus		
			805	Deposit	0.45	-	Fill of ditch (un-excavated)		
			806	Cut	0.45	-	Ditch (un-excavated)		
			807	Layer	-	-	Spread (un-excavated)	flint	
			808	Cut	-	-	Edge of spread (unexcavated)		
			809	Void	-				
			810	Deposit	1.22	0.52	Fill of ditch	Pot	LIA
			811	Cut	1.22	0.52	Ditch		
			812	Layer	-	-	Natural: Clay		
			813	Cut	0.80	0.17	Pit		
			814	Deposit	0.80	0.17	Fill of pit		
			815	Deposit	0.13	0.09	Fill of pit	flint	
			816	Cut	0.13	0.09	Pit		
009	No	0.3							
			900	Layer	-	0.26	Topsoil		
			901	Layer	-	0.28	Subsoil		
			902	Layer	-	-	Natural: Sandy clay		
010	Yes	0.35							

			1000	Layer	-	0.20	Topsoil		
			1001	Layer	-	0.15	Subsoil		
			1002	Deposit	0.44	0.10	Fill of gully		
			1003	Cut	0.44	0.10	Gully		
			1004	Cut	0.44	0.34	Gully/ditch		
			1005	Deposit	0.38	0.28	Fill of gully	Pot	
			1006	Deposit	0.44	0.16	Fill of gully	Pot	LIA
			1007	Layer	-	-	Natural: Silty clay		
			1008	Deposit	0.65	0.12	Fill of pit		
			1009	Cut	0.65	0.12	Pit (?)		
			1010	Cut	1.6	0.20	Bioturbation		
			1011	Deposit	1.6	0.20	Fill of bioturbation		
			1012	Cut	0.30	0.20	Posthole		
			1013	Deposit	0.30	0.20	Fill of posthole		
011	Yes	0.35							
			1100	Layer	-	0.18	Topsoil		
			1101	Layer	-	0.18	Subsoil		
			1102	Deposit	0.60	0.16	Fill of gully		
			1103	Cut	0.60	0.16	Gully		
012	Yes	0.4							
			1200	Layer		0.20	Topsoil		
			1201	Layer		0.18	Subsoil		
			1202	Deposit	1.60	0.20	Fill of ditch	CBM	Roman
			1203	Deposit	1.60	0.16	Fill of ditch		
			1204	Cut	2.00	0.40	Ditch		
			1205	Cut	0.60	0.40	Ditch		
			1206	Layer	-	-	Natural: Silty clay		
013	Yes	0.4							
			1300	Layer	-	0.42	Topsoil		
			1301	Layer	-	0.25	Subsoil		
			1302	Deposit	0.6	0.08	Fill of ditch		
			1303	Cut	0.6	0.08	Ditch		
			1304	Deposit	0.80	0.42	Fill of ditch	Flint	
			1305	Cut	0.80	0.42	Ditch	Flint	
			1306	Deposit	0.16	0.05	Fill of gully		

			1307	Cut	0.16	0.05	Gully		
			1308	Deposit	0.78	0.16	Fill of ditch	Flint	
			1309	Deposit	0.55	0.13	Fill of ditch		
			1310	Cut	0.78	0.16	Ditch	Flint	
014	Yes	0.5							
			1400	Layer			Topsoil		
			1401	Layer			Subsoil		
			1402	Cut	0.34	0.10	Gully		
			1403	Deposit	0.34	0.10	Fill of gully	Pot	PM
			1404	Cut	0.08	0.05	Hedge line		
			1405	Deposit	0.80	0.05	Fill of hedge line		
			1406	Cut	0.62	0.09	Gully		
			1407	Deposit	0.62	0.09	Fill of gully		
015	Yes	0.5							
			1500	Layer			Topsoil		
			1501	Layer			Subsoil		
			1502	Layer			Natural: Greensand		
			1503	Cut	0.30	0.20	Ditch		
			1504	Deposit	0.30	0.20	Fill of ditch		
			1505	Cut	0.90	0.40	Curvilinear gully		
			1506	Deposit	0.90	0.40	Fill of gully		
			1507	Cut	0.60	0.30	Ditch/gully		
			1508	Deposit	0.60	0.30	Fill of ditch/gully		
			1509	Cut	0.40	0.16	Posthole		
			1510	Deposit	0.40	0.16	Fill of posthole		
			1511	Deposit	0.20	0.04	Fill of posthole		
			1512	Cut	0.40	0.12	Gully		
			1513	Deposit	0.40	0.12	Fill of gully		
			1514	Cut	0.20	0.05	Gully		
			1515	Deposit	0.20	0.05	Fill of gully		
			1516	Cut	0.35	0.15	Ditch	Flint	
			1517	Deposit	0.35	0.15	Fill of ditch	Flint	
			1518	Cut	0.80	0.22	Ditch	Pot	
			1519	Deposit	0.60	0.10	Fill of ditch	Pot	LIA
			1520	Deposit	0.80	0.12	Fill of ditch	Pot	LIA

			1521	Cut	0.90	0.20	Ditch		
			1522	Deposit	0.90	0.20	Fill of ditch		
			1523	Cut	1.2	0.40	Ditch	Pot	
			1524	Deposit	0.60	1.4	Fill of ditch	Pot	MBA
			1525	Deposit	1.2	0.25	Fill of ditch		
016	Yes	0.4							
			1600	Layer	-	0.20	Topsoil		
			1601	Layer	-	0.21	Subsoil		
			1602	Layer	-	-	Natural		
			1603	Cut	1.37	0.10	Pit		
			1604	Deposit	1.37	0.10	Fill of pit		
			1605	Cut	0.36	0.18	Gully	Bone	
			1606	Deposit	0.36	0.18	Fill of gully		
			1607	Cut	0.40		Bioturbation		
			1608	Deposit	0.40		Fill of bioturbation		
017	Yes	0.65							
			1700	Layer	-	0.20	Topsoil	flint	
			1701	Layer	-	0.45	Subsoil		
			1702	Layer	-	-	Natural		
			1703	Cut	0.65	0.20	Pit		
			1704	Deposit	0.65	0.20	Fill of pit	Flint/B stone	
			1705	Cut	2.00	0.60	Ditch		
			1706	Deposit	2.00	0.35	Fill of ditch		
			1707	Deposit	0.85	0.10	Fill of ditch	Pot, flint	MBA
			1708	Deposit	1.25	0.18	Fill of ditch		
			1709	Cut	1.20	0.28	Ditch		
			1710	Deposit	1.20	0.28	Fill of ditch		
			1711	Cut	0.60	0.20	Gully		
			1712	Deposit	0.60	0.20	Fill of gully		
			1713	Cut	0.40	0.12	Gully terminal		
			1714	Deposit	0.40	0.12	Fill of gully terminal		
			1715	Cut	-	-	Ice wedge		
			1716	Deposit	-	-	Fill of ice wedge		
			1717	Cut	0.80	0.18	Gully		
			1718	Deposit	0.80	0.18	Fill of gully		

018	Yes	0.5							
			1800	Layer	-		Topsoil		
			1801	Layer	-		Subsoil		
			1802	Cut	0.40	0.30	Ditch		
			1803	Deposit	0.40	0.30	Fill of ditch		
			1804	Layer	-	-	Natural		
019	Yes	0.5							
			1901	Layer			Topsoil	Flint	
			1902	Layer	-		Subsoil		
			1903	Layer	-	-	Natural: Sandy silt		
			1904	Deposit	1.60	0.70	Fill of ditch		
			1905	Cut	1.60	0.70	Ditch		
			1906	Deposit	0.50	0.15	Fill of ditch		
			1907	Cut	0.50	0.15	Ditch		
			1908	Cut	1.49	0.52	Ring ditch		
			1909	Deposit	1.49	0.52	Fill of ring ditch		
			1910	Cut	0.30	0.10	Posthole		
			1911	Deposit	0.30	0.10	Fill of posthole		
			1912	Deposit	0.20	0.10	Fill of ditch 1905		
			1913	Deposit	0.20	0.25	Fill of ring ditch 1908		
020	Yes	0.45							
			2000	Layer	-	0.21	Topsoil		
			2001	Layer	-	0.23	Subsoil		
			2002	Layer	-	-	Natural: Clay sand		
			2003	Cut	2.00	0.35	Ditch		
			2004	Deposit	2.00	0.35	Fill of ditch	Flint	
			2005	Cut	1.5	0.60	Ditch	Flint	
			2006	Deposit	1.5	0.60	Fill of ditch	Pot	MBA
			2007	Cut	0.50	0.20	Gully		
			2008	Deposit	0.30	0.20	Fill of gully		
			2009	Cut	0.60	0.19	Gully		
			2010	Deposit	0.60	0.19	Fill of gully		
			2011	Cut			Tree throw		
			2012	Deposit			Fill of tree throw		
021	Yes	0.5							

			2100	Layer	-		Topsoil		
			2101	Layer	-		Subsoil		
			2102	Layer	-	-	Natural		
			2103	Cut	0.40	0.20	Gully		
			2104	Deposit	0.40	0.20	Fill of gully		
			2105	Cut	0.40	0.10	Gully		
			2106	Deposit	0.40	0.10	Fill of gully		
			2107	Cut	1.90	0.50	Ditch		
			2108	Deposit	1.10	0.20	Fill of ditch		
			2109	Deposit	1.00	0.08	Fill of ditch		
			2110	Deposit	1.90	0.30	Fill of ditch		
			2111	Layer	2.00	0.18	Bank/ up-cast spoil		
			2112	Layer	1.00	0.22	Bank/ up-cast spoil		
			2113	Layer	1.40	0.22	Bank/ up-cast spoil		
			2114	Cut			Tree throw		
			2115	Deposit			Fill of tree throw		
			2116	Cut	0.80	0.30	Ditch	Pot	
			2117	Deposit	0.70	0.12	Fill of ditch	pot	LIA
			2118	Deposit	0.80	0.18	Fill of ditch		
			2119	Cut	0.30	0.05	Posthole		
			2120	Deposit	0.30	0.50	Fill of posthole		
			2121	Cut	0.10	0.07	Stakehole		
			2122	Deposit	0.10	0.07	Fill of stake hole		
			2123	Cut	0.10	0.06	Stake hole		
			2124	Deposit	0.10	0.06	Fill of stake hole		
			2125	Deposit	0.10	0.10	Fill of gully 2103		
			2126	Cut			Pit		
			2127	Deposit			Fill of pit		
022	Yes	0.4							
			2201	Layer	-	0.20	Topsoil	Flint	
			2202	Layer	-	0.40	Subsoil	Pot, Flint	LPREH
			2203	Layer	-	0.34	Supranatural		
			2204	Layer	-	0.18	Iron panning		
			2205	Layer	-	-	Natural: Silty sand		
			2206	Cut	0.41	0.08	Gully		

			2207	Deposit	0.41	0.08	Fill of gully		
			2208	Layer	-	-	Natural: Silty sand		
023	Yes	0.5							
			2301	Layer	-	0.22	Topsoil	Flint	
			2302	Layer	-	0.14		Pot	ER
			2303	Layer	-	-	Natural: Clay sand		
			2304	Deposit	0.76	0.23	Fill of ditch	Flint	
			2305	Cut	0.76	0.23	Cut of ditch	Flint	
			2306	Deposit	1.82	0.35	Fill of ditch		
			2307	Cut	1.82	0.35	Ditch		
			2308	Deposit	0.78	0.07	Fill of ditch	Pot	Rom
			2309	Cut	0.78	0.07	Ditch		
024	Yes	0.6							
			2401	Layer	-	0.30	Topsoil	Flint	
			2402	Layer	-	0.30	Subsoil	Flint	
			2403	Deposit	1.10	0.52	Fill of ditch		
			2404	Cut	1.10	0.52	Ditch		
			2405	Layer	-	-	Natural: Sandy clay		
025	No	0.8							
			2501	Layer	-	0.23	Topsoil	Flint	
			2502	Layer	-	0.44	Subsoil		
			2503	Layer	-	-	Natural: Sandy clay		
026	Yes	0.4							
			2601	Layer	-	0.30	Topsoil		
			2602	Layer	-	0.30	Subsoil		
			2603	Layer	-	0.20	Subsoil		
			2604	Layer	-	-	Natural: Clay		
			2605	Cut	0.40	0.05	Gully		
			2606	Deposit	0.40	0.05	Fill of gully		
			2607	Cut	0.60	-	Furrow (unexcavated)		
			2608	Deposit	0.60	-	Fill of furrow (unexcavated)	Pot	Rom
			2609	Cut	3.20	0.35	Ditch		
			2610	Deposit	1.60	0.30	Fill of ditch		
			2611	Deposit	1.5	0.25	Fill of ditch		
			2612	Layer	-	-	Lynchets		

			2613	Layer	-	-	Lynchet		
027	Yes	0.3							
			2701	Layer	-		Topsoil		
			2702	Deposit	0.95	0.28	Fill of ditch re-cut		
			2703	Cut	0.95	0.28	Re-cut ditch		
			2704	Deposit	1.44	0.44	Fill of ditch		
			2705	Cut	1.44	0.44	Ditch		
			2706	Layer	-	-	Natural: Sandy clay		
028	No	0.9							
029	Yes	0.66							
			2901	Layer	-		Topsoil		
			2902	Layer	-		Subsoil		
			2903	Layer	-	-	Natural: Sandy clay		
			2904	Cut	1.06	0.56	Pit	B stone	
			2905	Deposit	0.56	0.40	Fill of pit	B stone	
			2906	Deposit	0.20	0.20	Fill of pit		
			2907	Deposit	0.22	0.38	Fill of pit		
			2908	Cut	2.61	0.14	Furrow		
			2910	Deposit	2.61	0.14	Fill of furrow		
030	Yes	0.2							
			3000	Layer	-	0.24	Topsoil	Slag, tile, Pot, bone, Flint	MBA? Roman, Med, PM
			3001	Layer	-	0.10	Subsoil		
			3002	Layer	-	-	Natural		
			3003	Layer	-	-	Occupation layer (unexcavated)	Pot	LR
			3004	Layer	-	0.10	Occupation layer (unexcavated)	Pot	Rom
			3005	Cut	1.00	-	Ditch (unexcavated)		
			3006	Deposit	1.00	-	Fill of ditch (unexcavated)		
			3007	Cut	3.00	-	Ditch (unexcavated)		
			3008	Deposit	3.00	-	Fill of ditch (unexcavated)	Box flue tile, Flint	Roman
031	Yes	0.5							
			3100	Layer	-	0.25	Topsoil	Roof tile, pot, Flint	M, PM



			3101	Layer	-	0.25	Subsoil		
			3102	Layer	-	0.20	Subsoil		
			3103	Layer	-	-	Natural		
			3104	Deposit	2.86	0.55	Fill of ditch	Pot	LR
			3105	Cut	2.86	0.55	Ditch		
			3106	Cut			Ditch (unexcavated)		
			3107	Deposit			Fill of ditch (unexcavated)		
			3108	Cut			Ditch (unexcavated)		
			3109	Deposit			Fill of ditch (unexcavated)		LR
			3110	Layer			Occupation layer (unexcavated)	Box flue tile, Pot	Roman
			3111	Cut			Ditch (unexcavated)		
			3112	Deposit			Fill of ditch (unexcavated)		
			3113	Cut			Ditch (unexcavated)		
			3114	Deposit			Fill of ditch (unexcavated)		
			3115	Cut			Ditch (unexcavated)		
			3116	Deposit			Fill of ditch (unexcavated)	Pot	ER
			3117	Cut			Ditch (unexcavated)		
			3118	Deposit			Fill of ditch (unexcavated)	Pot	ER
			3119	Deposit			Fill of ditch (unexcavated)		
			3120	Cut			Ditch(unexcavated)		
			3121	Deposit			Fill of ditch (unexcavated)		
			3122	Cut			Post hole (unexcavated)		
			3123	Deposit			Fill of post hole (unexcavated)		
032	Yes	0.5							
			3200	Layer	-	0.12	Topsoil	Pot	LR
			3201	Layer	-	0.30	Subsoil		
			3202	Cut			Ditch (unexcavated)		
			3203	Deposit			Fill of ditch (unexcavated)		
			3204	Cut			Ditch (unexcavated)		

			3205	Deposit			Fill of ditch (unexcavated)		
			3206	Cut			Ditch (unexcavated)		
			3207	Deposit			Fill of ditch (unexcavated)	Slag, plain tile, pot	Roman
			3208	Cut			Ditch (unexcavated)		
			3209	Deposit			Fill of ditch (unexcavated)		
			3210	Cut			Ditch (unexcavated)		
			3211	Deposit			Fill of ditch (unexcavated)	Pot	Rom
			3212	Cut			Ditch (unexcavated)		
			3213	Deposit			Fill of ditch (unexcavated)		
			3214	Cut			Ditch (unexcavated)		
			3215	Deposit			Fill of ditch (unexcavated)		
			3216	Cut			Posthole (unexcavated)		
			3217	Deposit			Fill of post hole (unexcavated)		
			3218	Cut			Ditch (unexcavated)		
			3219	Deposit			Fill of ditch (unexcavated)		
			3220	Cut			Gully (unexcavated)		
			3221	Deposit			Fill of gully (unexcavated)		
			3222	Cut			Posthole (unexcavated)		
			3223	Deposit			Fill of post hole (unexcavated)		
			3224	Cut			Tree throw (unexcavated)		
			3225	Deposit			Fill of tree throw (unexcavated)		
			3226	Layer		0.10	Buried soil (unexcavated)		
			3227	Layer			Natural		
033	Yes	0.5							
			3300	Layer	-	0.20	Topsoil		
			3301	Layer	-	0.30	Subsoil		
			3302	Layer	-	-	Natural: Sandy clay		

			3303	Cut	1.00	-	Linear (unexcavated)	Pot	
			3304	deposit	1.00	-	Fill of linear (unexcavated)	Pot	Rom
			3305	Cut	0.50	-	Linear (unexcavated)		
			3306	Deposit	0.50	-	Fill of linear (unexcavated)		
			3307	Cut	0.70	-	Linear (unexcavated)		
			3308	deposit	0.70	-	Fill of linear (unexcavated)		
			3309	Cut	0.70	-	Linear (unexcavated)		
			3310	Deposit	0.70	-	Fill of linear (unexcavated)		
			3311	Cut	1.2	-	Linear (unexcavated)		
			3312	Deposit	1.2	-	Fill of linear (unexcavated)		
			3313	Cut	1.6	-	Linear (unexcavated)		
			3314	Deposit	1.6	-	Fill of linear (unexcavated)		
034	No	0.4							
			3401	Layer	-	0.22	Topsoil	Pot, Flint	ER
			3402	Layer	-	0.38	Subsoil		
			3403	Layer	-	0.34	Natural: Sandy clay		
			3404	Layer	-	0.27	Natural: Sandy clay		
			3405	Layer	-	0.04 - 0.12	Natural: Sandstone/Greensand?		
			3406	Layer	-	0.80	Natural: Sandy clay		
035	No	0.6							
			3500	Layer	-	0.25	Ploughsoil		
			3501	Layer	-	0.40	Subsoil	Flint	
			3502	Layer	-	-	Natural: Sand		
036	No	0.6							
			3601	Layer	-	0.20	Topsoil	Flint	
			3602	Layer	-		Subsoil	Pot	MR
			3603	Layer	-		Natural: Clay sand		
			3604	Layer	-		Natural: Clay sand		
			3605	Layer	-	-	Greensand/sandstone		
037	No	0.5							
			3701	Layer	-	0.25	Topsoil	Flint	

			3702	Layer	-	0.24	Subsoil		
			3703	Layer	-	-	Natural: Sandy gravel		
038	No	0.45							
			3801	Layer	-	0.16	Topsoil		
			3802	Layer	-	0.17	Subsoil		
			3803	Layer	-	-	Natural: Sandy clay		
039	Yes	0.50							
			3901	Layer	-	0.20	Topsoil		
			3902	Layer	-	0.33	Subsoil		
			3903	Layer	-	-	Natural: Silty clay		
			3904	Object	-	-	Sarsen stone		
			3905	Cut	0.98	0.25	Ditch		
			3906	Deposit	0.98	0.25	Fill of ditch	Pot, Flint	LIA
			3907	Cut			Tree throw		
			3908	Deposit			Fill of tree throw		
			3909	Cut			Plough scar		
			3910	Deposit			Fill of plough scar		
040	No	0.55							
			4001	Layer	-	0.20	Topsoil		
			4002	Layer	-	0.35	Subsoil		
			4003	Layer	-	-	Natural		
041	Yes	0.8							
			4101	Layer	-	0.28	Topsoil		
			4102	Layer	-	0.50	Subsoil		
			4103	Deposit	0.80	0.35	Fill of ditch		
			4104	Deposit	0.24	0.03	Fill of ditch		
			4105	Cut	0.80	0.35	Ditch		
042	No	0.9							
			4201	Layer	-	0.36	Ploughsoil	-	Medieval
			4202	Layer	-	0.4	Subsoil	-	
			4203	Layer	-	0.2	Buried soil/colluvium	-	Undated
			4204	Layer	-	0.9	Natural Greensand		
			4205	Layer	-		Natural clay	-	
043	No	0.25							
			4301	Layer	-	0.24	Ploughsoil	-	Medieval

			4302	Layer	-	-	Natural clay	-	
			4303	Cut	0.15	0.07	Stakehole	-	Undated
			4304	Deposit	0.15	0.07	Fill of stakehole	-	Undated
044	No	0.7							
			4401	Layer	-	0.26	Ploughsoil	-	Medieval
			4402	Layer	-	0.41	Subsoil	-	
			4403	Layer	-	-	Natural clays/gravels	-	
045	No	0.45							
			4501	Layer	-	0.22	Ploughsoil	-	Medieval
			4502	Layer	-	0.21	Subsoil	-	
			4503	Layer	-		Natural clays/gravels	-	
048	Yes	0.5							
			4801	Layer			Ploughsoil		
			4802	Layer	-	0.18	Re-deposited natural		
			4803	Layer	-	0.20	Buried soil		
			4804	Deposit	-	0.22	Fill of ditch		
			4805	Layer	-	0.38	Re-deposited natural		
			4806	Layer	-	-	Natural clay		
			4807	Deposit	-	0.48	Fill of terrace/ditch	Pot	L11thC
			4808	Cut	-	-	Terrace/ditch		
			4809	Layer	-	0.40	Earthwork makeup layer	Pot	L12thC
			4812	Layer	-	-	Subsoil		
			4813	Deposit	0.60	0.34	Fill of ditch	Pot	L11thC
			4814	Cut	0.60	0.34	Ditch		
			4815	Deposit			Fill of tree throw	Pot	L11thC
			4816	Cut			Tree throw		
			4817	Deposit	2.2	0.41	Fill of palaeochannel		
			4818	Cut	2.2	0.41	Palaeochannel		
			4819	Layer	-	0.20	Re-deposited sandstone		
			4820	Layer	-	0.38	Redeposited subsoil		
			4821	Cut	2.2		Ditch (?)		
			4822	Deposit	2.86	0.31	Fill of ditch		
			4823	Cut	2.86	0.31	Cut of ditch		
			4824	Layer	0.64	0.38	Bank/up-cast spoil		
			4825	Cut	1.28	0.46	Ditch		

			4826	Deposit	1.28	0.46	Fill of ditch		
049	Yes	0.45							
			4901	Layer	-	0.15	Topsoil	Pot	L11thC
			4902	Layer	-	0.20	Subsoil		
			4903	Cut	1.00	-	Pit (unexcavated)		
			4904	Deposit	1.00	-	Fill of pit (unexcavated)	Pot	LBA or EIA
			4905	Cut	1.5	-	Pit (unexcavated)		
			4906	Deposit	1.5	-	Fill of pit (unexcavated)	Pot	LPRE
			4907	Cut	0.60	-	Ditch (unexcavated)		
			4908	Deposit	0.60	-	Fill of ditch (unexcavated)		
			4909	Cut	0.20	-	Sub circular posthole (unexcavated)		
			4910	Deposit	0.20	-	Fill of sub circular pit (unexcavated)		
			4911	Cut	0.20	-	Sub circular posthole (unexcavated)		
			4912	Deposit	0.20	-	Fill of sub circular (unexcavated)		
			4913	Cut	0.15	-	Posthole (unexcavated)		
			4914	Deposit	0.15	-	Fill of pit (unexcavated)		
			4915	Cut	-	-	Ditch		
			4916	Deposit	-	-	Fill of ditch		
			4917	Cut	1.2	-	Recut of ditch		
			4918	Deposit	1.2	-	Fill of recut		
			4919	Cut	0.50	-	Curvilinear ditch		
			4920	Deposit	0.50	-	Fill of curvilinear		
			4921	Cut	0.9	-	Ditch		
			4922	Deposit	0.9	-	Fill of ditch		
			4923	Cut	0.30	-	Sub-circular posthole		
			4924	Deposit	0.30	-	Fill of pit		
			4925	Layer	-	0.20	Natural: Clay silt		
			4926	Layer	-	-	Natural: Clay		
050	Yes	0.25							
			5001	Layer	-	0.15	Topsoil		
			5002	Layer	-	0.20	Subsoil		
			5003	Layer	-	-	Natural: Clay		

			5004	Cut			Ditch		
			5005	Deposit			Fill of ditch		
052	Yes	0.6							
			5201	Layer			Topsoil		
			5202	Layer			Subsoil		
			5203	Layer			Natural: Clay		
			5204	Cut	0.50	0.10	Ditch	Pot	
			5205	Deposit	0.50	0.10	Fill of ditch	Pot	L11thC
			5206	Cut	0.43	0.07	Ditch		
			5207	Deposit	0.43	0.07	Fill of ditch	Pot	L11thC
			5208	Cut	0.43	0.12	Ditch		
			5209	Deposit	0.43	0.12	Fill of ditch	Pot	L11thC
			5210	Cut	0.47	0.08	Ditch		
			5211	Deposit	0.47	0.08	Fill of ditch	Pot	
			5212	Cut		0.22	Ditch terminal		
			5213	Deposit		0.22	Fill of ditch terminal	Pot, bone	L11thC
			5214	Deposit		0.05	Fill of ditch terminal		
			5215	Cut	0.40	0.04	Bioturbation		
			5216	Deposit	0.40	0.04	Fill of bioturbation		
			5217	Cut	0.95	0.47	Ditch		
			5218	Deposit	0.95	0.47	Fill of ditch	Bone	
			5219	Cut	1.75	0.36	Ditch		
			5220	Deposit	1.75	0.36	Fill of ditch	Lots of Bone	13th C
			5221	Cut	0.95	0.40	Ditch		
			5222	Deposit	0.95	0.40	Fill of ditch	Bone, B stone	
			5223	Cut	1.01	0.14	Linear		
			5224	Deposit	1.01	0.143	Fill of linear	Pot, bone	11th C
			5225	Cut	0.76	0.15	Ditch		
			5226	Deposit	0.76	0.15	Fill of ditch		
			5227	Cut	0.30	0.16	Ditch		
			5228	Deposit	0.30	0.16	Fill of ditch	Pot	IND
			5229	Cut	4.51	0.62	Ditch		
			5230	Deposit	4.51	0.62	Fill of ditch	Pot, metal	L11th C
053	Yes	0.5							

			5300	Layer	-	0.18	Topsoil		
			5301	Layer	-	0.09	Subsoil		
			5302	Layer	-	-	Natural:		
			5303	Cut	2.90	-	Ditch (unexcavated)		
			5304	Deposit	2.90	-	Fill of ditch (unexcavated)		
			5305	Cut	3.00	0.18	Sub circular pit (partially excavated)		
			5306	Deposit	3.00	0.12	Fill of pit (partially excavated)	Pot	L11th C
			5307	Deposit	-	0.06	Fill of pit (partially excavated)	Pot	IND
			5308	Cut	2.7	-	Ditch (unexcavated)		
			5309	Deposit	2.7	-	Fill of ditch (unexcavated)		
			5310	Cut	4.60	-	Ditch (unexcavated)		
			5311	Deposit	4.60	-	Fill of ditch (unexcavated)	Pot	L11th C
			5312	Cut	2.54	0.92	Ditch (partially excavated)		
			5313	Deposit	2.54	0.41	Fill of ditch (partially excavated)	Pot	L11th C
			5314	Deposit	2.54	0.51	Fill of ditch (partially excavated)	Pot, bone	LPREH
			5315	Layer	-	0.5	Colluvium: Silty clay (unexcavated)	Pot, Flint	L11th C
			5316	Cut	0.95	0.22	Ditch	Pot	L11th C
			5317	Deposit	0.95	0.22	Fill of ditch	Pot	L11th C & LPREH
			5318	Cut	0.30	-	Ditch (unexcavated)		
			5319	Deposit	0.30	-	Fill of ditch (unexcavated)	Pot	L11th C
			5320	Cut	1.6	-	Ditch terminal (unexcavated)	Pot	L11th C
			5321	Deposit	1.6	-	Fill of ditch terminal (unexcavated)		
054	Yes	0.7							
			5401	Layer	-	0.20	Topsoil		
			5402	Layer	-	0.18	Subsoil		
			5403	Deposit	4.30	0.44	Fill of linear		



			5404	Cut	4.30	0.44	Linear		
			5405	Deposit	1.8	0.40	Natural : Silty clay		
			5406	Layer	-	-	Natural: Silty clay		
			5407	Deposit	0.40	-	Fill of pit (unexcavated)	Flint	
			5408	Cut	0.40	-	Pit (unexcavated)		
			5409	Layer	-	-	Spoil heaps	Pot	LPREH
055	No	0.2	5501	Layer	-	0.19	Topsoil		
			5502	Layer	-	0.14	Subsoil		
			5503	Layer	-	-	Natural: Boulder clay		
056	Yes	0.25							
			5601	Layer	-	0.19	Topsoil		
			5602	Layer	-	0.15	Earthworks		
			5603	Layer	-	-	Natural: Boulder clay		
058	No	0.2							
			5801	Layer	-	0.19	Topsoil		
			5802	Layer	-	-	Natural: Boulder clay		
059	No	0.2							
			5901	Layer	-	0.19	Topsoil		
			5902	Layer	-		Subsoil		
			5903	Layer	-	0.10	Natural: Iron panning		
			5904	Layer	-	-	Natural: Sandy clay		
			5905	Cut	4.8	0.74	Palaeochannel		
			5906	Layer	-	-	Alluvium		
			5907	Layer			Re-deposited natural		
			5908	Layer			Re-deposited natural		
063	Yes	0.45							
			6301	Layer	-	0.23	Topsoil		
			6302	Layer	-	0.21	Subsoil		
			6303	Layer	-	-	Natural: Silty clay		
			6304	Deposit			Fill of ditch	Pot	Rom
			6305	Cut			Cut of ditch		
064	No	0.5							
			6401	Layer	-	0.23	Topsoil		
			6402	Layer	-	0.24	Subsoil		
			6403	Layer	-	-	Natural: Boulder clay		

065	No	0.2							
			6501	Layer	-	0.21	Topsoil		
			6502	Layer	-	0.49	Natural: Boulder clay		
066	No	0.3							
			6600	Layer	-	0.15	Topsoil		
			6601	Layer	-	0.15	Subsoil		
			6602	Layer	-	-	Natural: Clay		
067	No	0.55							
			6701	Layer	-	0.29	Topsoil (waterlogged)		
			6702	Layer	-	0.27	Subsoil (waterlogged)		
			6703	Layer	-	-	Natural: (waterlogged)		
068	Yes	0.2							
			6801	Layer	-	0.19	Topsoil (waterlogged)		
			6802	Layer	-	-	Natural (waterlogged)		
071	No	0.2							
			7101	Layer	-	0.22	Topsoil		
			7102	Layer	-	0.22	Natural: Clay		
072	No	0.15							
			7201	Layer	-	0.14	Topsoil (waterlogged)		
			7202	Layer	-	-	Natural: Clay (waterlogged)		
073	No	0.4							
			7301	Layer	-	0.21	Topsoil		
			7302	Layer	-	0.17	Subsoil		
			7303	Layer	-	-	Natural: Clay		
074	Yes	0.4							
			7400	Layer	-		Topsoil		
			7401	Layer	-		Subsoil		
			7402	Layer	-	-	Natural: Clay		
			7403	Deposit			Fill of Pit/treethrow		
			7404	Cut			Pit/treethrow	Flint	
			7405	Cut	0.68	0.05	Furrow		
			7406	Deposit	0.68	0.05	Fill of furrow	Pot	LPREH
			7407	Layer	?	?	Earthwork	Pot	MR
			7408	Layer			Ridge		
075	Yes	0.3							

			7500	Layer	-	0.22	Topsoil		
			7501	Layer	-	0.22	Subsoil		
			7502	Layer	-	-	Natural: Silty clay		
			7503	Layer	2.2		Spread of stones		
			7504	Cut	6.00		Ditch (waterlogged)		
			7505	Deposit	6.00		Fill of ditch (waterlogged)	Pot	L11thC
			7506	Layer			Bank, up-cast spoil		
			7507	Cut	0.80	0.30	Pit		
			7508	Deposit			Fill of pit	Pot	11th C
076	No	0.4							
			7600	Layer	-	0.18	Topsoil		
			7601	Layer	-	0.24	Subsoil		
			7602	Layer	-	-	Natural: Clay		
			7603	Cut	26.00	2.00	Palaeochannel		
			7604	Deposit	26.00	2.00	Fill of palaeochannel		
077	No	0.45							
			7701	Layer	-	0.24	Topsoil		
			7702	Layer	-	0.21	Subsoil		
			7703	Layer	-	-	Natural: Clay		
078	No	0.45							
			7800	Layer	-	0.14	Topsoil		
			7801	Layer	-	0.29	Subsoil		
			7802	Layer	-	-	Natural: Clay		
079	Yes	0.35							
			7900	Layer	-	0.11	Topsoil		
			7901	Layer	-	0.23	Subsoil		
			7902	Layer	-	-	Natural: Clay		
			7903	Cut	0.67	0.09	Ridge & furrow		
			7904	Deposit	0.67	0.09	Fill of ridge & furrow	Pot	Rom?
			7905	Cut	0.52	0.11	Pit		
			7906	Deposit	0.52	0.11	Fill of pit		
			7907	Cut	0.48	0.30	Curvilinear ditch		
			7908	Deposit	0.24	0.30	Fill of curvilinear		
			7909	Cut	0.52	0.12	Curvilinear ditch terminal		

			7910	Deposit	0.52	0.10	Fill of curvilinear terminal		
			7911	Deposit	0.48	0.30	Secondary fill of terminal		
080	No	0.35							
			8001	Layer	-	0.25	Topsoil		
			8002	Layer	-	0.10	Subsoil	Pot	Rom
			8003	Layer	-	-	Natural: Clay		
081	No	0.35							
			8100	Layer	-	-	Natural: Clay		
			8101	Layer	-	0.18	Subsoil		
			8102	Layer	-	0.09	Topsoil		
082	No	0.45							
			8200	Layer	-	0.20	Topsoil		
			8201	Layer	-	0.10	Subsoil	Pot, Flint	IND
			8203	Layer	-	-	Natural: Clay		
083	Yes	0.3							
			8301	Layer	-	0.20	Topsoil		
			8302	Layer	-	0.10	Subsoil	Pot	LIA
			8303	Void					
			8307	Deposit	-	-	Natural		
			8308	Cut	0.50	0.11	Gully		
			8309	Deposit	0.50	0.11	Fill of gully		
			8310	Cut	1.76	0.36	Ditch		
			8311	Deposit	1.76	0.36	Fill of ditch	Pot, Flint	LIA
			8312	Cut	1.40	0.44	Ditch		
			8313	Deposit	1.40	0.44	Fill of ditch		
			8314	Cut	-	-	Ditch (unexcavated)		
			8315	Deposit	-	-	Fill of ditch (unexcavated)		
084	Yes	0.4							
			8400	Layer	-	0.19	Topsoil		
			8401	Layer	-	0.22	Subsoil	Pot	LIA
			8402	Layer	-	-	Natural: Silty clay		
			8403	Deposit	0.63	0.21	Fill of ditch	Pot, Flint	MR
			8404	Deposit	1.10	0.24	Fill of ditch		
			8405	Deposit	0.58	0.16	Ditch		

			8406	Cut	1.10	0.70	Cut of ditch		
			8407	Deposit	1.66	0.54	Secondary fill of pit	Pot, Flint	MR
			8408	Deposit	0.57	0.13	Primary pit fill		
			8409	Cut	1.66	0.54	Pit		
			8410	Deposit	1.44	0.56	Fill of ditch re-cut		
			8411	Cut	1.44	0.56	Re-cut of ditch		
			8412	Deposit	2.16	0.77	Fill of ditch	Pot, bone, Flint	MR
			8413	Cut	2.16	0.77	Ditch		
			8414	Cut	0.77	0.13	Tree throw		
			8415	Deposit	0.77	0.13	Fill of tree throw		
			8416	Cut			Pit (unexcavated)		
			8417	Deposit			Fill of pit (unexcavated)		
			8418	Cut			Ditch (partially excavated)		
			8419	Deposit			Fill of ditch (partially excavated)		
085	Yes	0.3							
			8501	Layer	-	0.20	Topsoil	Pot	PM
			8502	Layer	-	0.10	Subsoil		
			8503	Layer	2.2	0.13	Stone spread	Pot	LPREH
			8504	Deposit	1.60	0.79	Fill of ditch	Flint	
			8505	Layer	-	-	Natural: Clay		
			8506	Cut	1.6	0.79	Ditch		
			8507	Layer	2.2	0.06	Fill of ditch		
			8508	Deposit	0.82	0.59	Fill of ditch		
			8509	Deposit	-	-	Fill of pit (unexcavated)		
			8510	Cut	1.00	-	Pit (unexcavated)		
			8511	Deposit	-	-	Fill of pit (unexcavated)		
			8512	Cut	1.00	-	Pit (unexcavated)		
			8513	Deposit	-	-	Fill of gully (unexcavated)		
			8514	Cut			Gully/ditch		
			8515	Deposit	-	-	Fill of pit (unexcavated)		
			8516	Cut	1.4	-	Pit (unexcavated)		
			8517	Deposit	-	-	Fill of pit (unexcavated)		

			8518	Cut	0.65	-	Pit (unexcavated)		
			8519	Deposit	-	-	Fill of pit (unexcavated)		
			8520	Cut	1.20	-	Pit (unexcavated)		
			8521	Deposit	-	-	Fill of ditch (unexcavated)		
			8523	Deposit	-	-	Fill of posthole (unexcavated)		
			8524	Cut	0.60	-	Posthole (unexcavated)		
			8525	Deposit	-	-	Fill of posthole (unexcavated)		
			8526	Cut	0.50	-	Posthole (unexcavated)		
			8527	Deposit	-	-	Fill of pit (unexcavated)		
			8528	Cut	1.2	-	Pit (unexcavated)		
086	No	0.6							
			8600	Layer	-	0.30	Topsoil		
			8601	Layer	-	0.30	Subsoil		
			8602	Layer	-	-	Natural: Silty clay		
087	No	0.6							
			8700	Layer	-	0.30	Topsoil		
			8701	Layer	-	0.30	Subsoil		
			8702	Layer	-	-	Natural: Silty clay		
088	No	0.6							
			8800	Layer	-	0.30	Topsoil		
			8801	Layer	-	0.30	Subsoil		
			8802	Layer	-	-	Natural: Clay		
089	No	0.7							
			8900	Layer	-	0.30	Topsoil		
			8901	Layer	-	0.40	Subsoil		
			8902	Layer	-	-	Natural: Clay		
090	No	0.6							
			9000	Layer	-	0.30	Topsoil		
			9001	Layer	-	0.30	Subsoil		
			9002	Layer	-	-	Natural: Clay		
091	Yes	0.45							
			9100	Layer	-	0.10	Topsoil		
			9101	Layer	-	0.10	Subsoil		
			9102	Layer	-	-	Natural: Silty clay		

			9103	Cut			Posthole (unexcavated)		
			9104	Deposit			Fill of posthole (unexcavated)		
			9105	Cut			Pit (unexcavated)		
			9106	Deposit			Fill of pit (unexcavated)		
			9107	Cut			Pit (unexcavated)		
			9108	Deposit			Fill of pit (unexcavated)		
			9109	Cut			Ditch (unexcavated)		
			9110	Deposit			Fill of ditch (unexcavated)		
			9111	Cut			Pit (unexcavated)		
			9112	Deposit			Fill of pit (unexcavated)		
			9113	Cut			Pit (unexcavated)		
			9114	Deposit			Fill of pit (unexcavated)		
			9115	Cut			Pit (unexcavated)		
			9116	Deposit			Fill of pit (unexcavated)		
			9117	Cut			Ditch (unexcavated)		
			9118	Deposit			Fill of ditch (unexcavated)		
			9119	Cut			Pit (unexcavated)		
			9120	Deposit			Fill of pit (unexcavated)		
			9121	Cut			Pit (unexcavated)		
			9122	Deposit			Fill of pit (unexcavated)		
			9123	Cut			Tree throw (unexcavated)		
			9124	Deposit			Fill of tree throw (unexcavated)		
			9125	Deposit			Fill of tree throw (unexcavated)		
			9126	Cut			Ditch terminal (unexcavated)		
			9127	Deposit			Fill of terminal (unexcavated)		
092	Yes	0.55							
			9201	Layer	-	0.22	Topsoil		
			9202	Layer	-	0.32	Subsoil	Pot	LPREH
			9203	Layer	-	-	Natural: Silty clay		
			9204	Cut	1.8	-	Pit/tree throw (unexcavated)		

			9205	Deposit	-	-	Fill of pit/tree throw (unexcavated)		
			9206	Cut	2.15	-	Pit (unexcavated)		
			9207	Deposit	-	-	Fill of pit (unexcavated)		
			9208	Cut	2.70	-	Ditch (unexcavated)		
			9209	Deposit	1.40	-	Fill of ditch (unexcavated)	Pot	LPREH
			9210	Deposit	1.30	-	Fill of ditch(unexcavated)		
			9211	Cut	0.60	-	Pit (unexcavated)		
			9212	Deposit	0.60		Fill of pit (unexcavated)		
			9213	Cut	0.50	-	Sub triangular feature (unexcavated)		
			9214	Deposit	-	-	Fill of triangular feature (unexcavated)		
			9215	Cut	0.90	-	Ditch (unexcavated)		
			9216	Deposit	-	-	Fill of ditch (unexcavated)		
			9217	Cut	0.15	-	Posthole (unexcavated)		
			9218	Deposit	-	-	Fill of posthole (unexcavated)		
			9219	Cut	0.30	-	Posthole (unexcavated)		
			9220	Deposit	-	-	Fill of posthole (unexcavated)		
			9221	Cut	0.30	-	Posthole (unexcavated)		
			9222	Deposit	-	-	Fill of posthole (unexcavated)		
			9223	Cut	-	-	Pit (unexcavated)		
			9224	Deposit	-	-	Fill of pit (unexcavated)		
			9225	Cut	3.30	-	Curvilinear ditch (unexcavated)		
			9226	Deposit	-	-	Fill of curvilinear (unexcavated)		
			9227	Cut	1.20	-	Pit (unexcavated)		
			9228	Deposit	-	-	Fill of pit (unexcavated)		
			9229	Cut			Posthole		
			9230	Deposit			Fill of posthole		
			9231	Cut			Pit		
			9232	deposit			Fill of pit		
			9233	Cut			Pit		



			9234	Deposit			Fill of pit		
			9235	Cut			Posthole		
			9236	Deposit			Fill of posthole		
			9237	Cut			Posthole		
			9238	Deposit			Fill of posthole		
			9239	Cut			Ditch		
			9240	Deposit			Fill of ditch		
			9241	Cut			Pit		
			9242	Deposit			Fill of pit	Pot	LPREH
			9243	Cut			Ditch		
			9244	Deposit			Fill of ditch		
093	Yes	0.6							
			9300	Layer			Topsoil		
			9301	Layer			Subsoil	Pot, Flint	LIA
			9302	Cut			Pit		
			9303	Deposit			Fill of pit		
			9304	Cut			Pit		
			9305	Object			Sarsen stone		
			9306	Deposit			Fill of pit	Pot, Flint	LPREH
			9307	Cut			Ditch		
			9308	Deposit			Fill of ditch		
			9309	Cut			Posthole		
			9310	Deposit			Fill of pit		
			9311	Cut			Posthole		
			9312	Deposit			Fill of pit	Pot	L11th C
			9313	Cut			Posthole		
			9314	Deposit			Fill of pit		
			9315	Cut			Posthole		
			9316	Deposit			Fill of pit		
			9317	Cut			Ditch		
			9318	Deposit			Fill of ditch		
			9319	Cut			Posthole		
			9320	Deposit			Fill of pit		
			9321	Cut			Posthole		
			9322	Deposit			Fill of pit		

			9323	Cut			Posthole		
			9324	Deposit			Fill of pit		
			9325	Cut			Posthole		
			9326	Deposit			Fill of pit		
			9327	Cut			Pit		
			9328	Deposit			Fill of pit		
			9329	Cut			Ditch		
			9330	Deposit			Fill of ditch		
			9331	Layer			Natural: Clay		
			9332	Cut			Ditch		
			9333	Deposit			Fill of ditch		
094	No	0.75							
			9401	Layer	-	0.30	Topsoil		
			9402	Layer	-	0.45	Subsoil		
			9403	Layer	-	-	Natural: Clay		

**APPENDIX 2 POTTERY ASSESSMENT/ SPOT DATING**

(LPREH: late prehistoric, IND: indeterminate, LBA: late Bronze Age, EIA: early Iron Age. Fabric codes, principal inclusion listed first. A: quartz sand, B: Greensand, F: flint, Pfe: ferruginous pellets, O: organic, numbers 1-3: size of principal inclusions in millimetres)

**Prehistoric pottery: quantification by context.**

Area/Trench	Context	Sherd Count	Weight (g)	Fabric	Date	Comments
1/1	112	1	3	APfeF1	LPREH	Body sherd
1/1	156	2	12	F1	LPREH	Body sherd
1/1	156	2	32	F5	MBA?	Base sherd
1/3	305	1	5	F1	LPREH	Body sherd
3/15	1524	1	55	F3	MBA	Biconical shaped Bucket Urn Rim (squared) to shoulder (carinated) sherd
3/17	1707	59	225	D3	MBA	Fragments of Barrel Urn
3/20	2006	14	30	D3	MBA	Fragments of Barrel Urn
4/22	2202	4	40	F1 & F2	LPREH	Body sherds
2/30	3000	4	30	Fpfe3	MBA?	Body sherds
7/49	4904	11	16	BF2	LBA or EIA	Concave neck
7/49	4906	3	6	AF3	LPREH	
7/52	5228	1	3	IND	IND	
7/53	5307	1	1	IND	IND	
7/53	5314	2	14	AF3	LPREH	
7/53	5314	1	3	BF3	LPREH	
7/53	5317	2	2	AF2	LPREH	
7/54	5409	4	9	BPfeF3	LPREH	
7/54	5409	2	7	BOF3	LPREH	

7/54	5409	1	5	BF2	LPREH	
7/74	7406	1	3	AF2	LPREH	
8/82	8201	1	2	IND	IND	
8/85	8503	23	81	BF4	LPREH	
8/85	8503	1	7	BF3	LBA or EIA	Rim
8/85	8503	3	8	BF3	LPREH	SS 2 Rim
8/85	8503	28	11	BF3	LPREH	SS 2. Rim
9/92	9202	2	7	AF3	LPREH	
9/92	9202	2	13	APfe3	LPREH	
9/92	9202	1	4	BF3	LPREH	Little rim
9/92	9202	1	4	B1	LBA or EIA	Shoulder with horizontal step
9/92	9209	1	7	AF3	LPREH	
9/92	9242	1	85	F	LBA	Base
9/93	9306	10	21	BPfeF3	LPREH	
9/93	9306	1	5	APfe3	LPREH	Concave neck
	U/S	5	45	BF3	LPREH	Fresh breaks
	Totals	197	801			

**Roman Pottery: quantification by context**

Context	Count	Weight (g)	Comments	Date
104	8	26	R10, E60, E20	43-100
118	1	7	E50	LIA
124	3	37	E20, E60	LIA
128	20	191	E80, E50 (HC)	LIA
130	3	13	E60 (C)	LIA
142	1	4	E60	LIA
146	2	57	E80 (CB)	LIA
150	15	170	E40, E60, E50 (CD)	LIA
162	3	11	E60 (C)	LIA
163	22	251	E80 (CH)	LIA
164	13	648	R90 (CC/CN), E80, E60	LIA
165	47	1002	E60, E80 (CD, CE), E50	LIA
168	5	17	E20	LIA
201	1	20	E80 (CH)	LIA
211	10	105	E60 (very coarse), E20	LIA
213	5	12	E60, E80	LIA
226	17	52	E60 (very coarse), E80	LIA
241	3	19	E50 (CH)	LIA
242	2	20	E60, E80	LIA
247	3	15	E60, E80	LIA
248	3	565	E80 - with flint in fabric	LIA
304	1	3	R30	ROM
401	1	78	R90 (CN)	ROM
402	8	52	R20 (CE), W21, E80	43-100
404	3	17	E80	LIA
406	7	155	E20 (CD, CE), R94 (CN), R30 (CE)	43-100
407	3	20	E20	LIA
411	2	12	E20, E50 (CH)	LIA
415	2	13	E80 (HC), E50	LIA
417	5	14	R10, O80	ROM
506	2	18	E20 (CH)	LIA
512	7	109	R30 (CE), E80, R20 (CE), W21 (MA)	50-100
604	3	40	E60/E80 (H)	LIA
610	3	10	E20	LIA
612	3	32	E80, R30, R94	43-100
614	1	17	E60	LIA

620	4	92	E60 (very coarse), E20	LIA
803	2	15	E80	LIA
810	1	34	E80/E13	LIA
1006	4	60	E80	LIA
1403	1	2	English porcelain	1800-1900
1519	1	4	E50	LIA
1520	1	9	E80	LIA
2117	2	2	E60	LIA
2302	1	99	R94 (CN)	43-300
2308	1	5	R90	ROM
2608	8	39	R94 (C)	43-300
3000	193	2062	Residual Roman (mainly 260-410, including Oxfordshire products, and notched R30 base (4+)); red earthenware, including rouletted piece possibly from Donyat pottery in Dorset	1700-1800
3003	37	706	B11 (CK), R30, F51, M32 (KE), Q30, O10, F53	250-410
3004	6	142	R94 (CN), R20	ROM
3100	36	407	R30 (residual), red earthenware	1700-1800
3104	50	730	B11 (bead-and-flanged dishes; JA100), S30, R10, R30 (CD), E60 (CH)	250-410
3109	11	147	B11 (JB100; CK), R10, O10 (ED)	250-410
3110	33	509	R95 (CN), B11, R30 (E)	125-300
3116	11	71	E60 (CB or E), R30	43-100
3118	2	15	R20 (CH)	43-150
3200	2	35	F51, B11 (CK)	250-410
3207	2	6	F52 (ED/EE), R20	200-410
3211	3	290	R94 (CN)	ROM
3304	7	167	B11 (JB100), R30 (E)	150-410
3401	4	20	R30, E60, E80	43-100
3602	2	29	B11 (CK), R20	125-250
3906	4	11	E60	LIA
7407	1	7	S30 (abraded footring)	M2-L2
8002	5	17	Oxidised abraded sherds	ROM
8302	2	9	E60 (necked jar)	LIA
8311	29	156	E30, E80	LIA
8401	1	8	E30	LIA
8403	21	84	W20, R30 (necked jar), O10, E80	M1-E2
8407	20	56	R30, E80, O10	M1-E2
8412	65	1302	R90 (large bead-rimmed jar), R20 (necked jar), R94	M1-E2
8501	2	4	R30 (residual)	PM
9301	2	12	E80, residual prehistoric sherd	LIA

***Medieval pottery: occurrence by number and weight (in g) of sherds per context by fabric type***

Context	RB		F200		F202		F1		F2		F425		Date
	No	Wt	No	Wt	No	Wt	No	Wt	No	Wt	No	Wt	
4807					34	346							L11thC
4809			1	5	1	12							L12thC
4813					9	63							L11thC
4815					1	4							L11thC
4901			2	3	8	49							L11thC
5205					1	5							L11thC
5207					1	4							L11thC
5209					3	37							L11thC
5213					2	17							L11thC
5220					39	605	2	21	1	12			13thC
5224			1	10									11thC
5230					2	20							L11thC
5306					3	8							L11thC
5311					1	14							L11thC

5313					2	20								L11thC
5315			1	14	8	109								L11thC
5316					3	37								L11thC
5317					1	4								L11thC
5319					4	12								L11thC
5320					1	1								L11thC
5322	1	2	1	14										11thC
5325					4	24								L11thC
5327			1	3	5	23								L11thC
5328							1	9						L12thC
5329					2	4								L11thC
5330					1	5								L11thC
6304	1	8												RB
7505					2	53								L11thC
7508			1	6										11thC
7904	1	6												RB??
8403	2	4												RB??
8501												1	1	M16thC
9312					2	13								L11thC
Total	5	20	8	55	140	1489	3	30	1	12	1	1		

## APPENDIX 3 WORKED FLINT

*The flint assemblage from the evaluation trenches by area*

CATEGORY TYPE	Area								Grand Total
	1	2	3	4	7	8	9		
Flake	6	1	43	142	4	6	3	205	
Blade		1	5	17				23	
Bladelet				14		1		15	
Blade-like	1		4	22				27	
Irregular waste	2		3	3		1		9	
Chip			2					2	
Micro burin				2				2	
Rejuvenation flake core face/edge				4				4	
Rejuvenation flake tablet				1				1	
Rejuvenation flake other				2				2	
Core single platform blade core				3				3	
Other blade core				1				1	
Tested nodule/bashed lump			1	6				7	
Single platform flake core			1	1				2	
Multiplatform flake core				2		2		4	
Levallois/ other discoidal flake core				1				1	
Core on a flake			1				1	2	
Unclassifiable/fragmentary core				2				2	
Microlith (subdivide)				1				1	
End scraper			2	2				4	
Side scraper				3				3	
End and side scraper				3				3	
Thumbnail scraper	1			2				3	
Other scraper	1		3	4				8	
Awl				1				1	
Piercer				2				2	
Other knife				1				1	
Retouched flake	1		1	5				7	
Burin				1				1	

Hammerstone				1				1
Grand Total	12	2	66	249	4	10	4	347

Burnt unworked flint (no./g)	1/13		10/68	5/32	2/30	13/56		31/199
No. burnt (%)*	2		2	12 (4.8)				16 (4.6)
No. broken (%)*	2	1	19	75 (30.1)				97 (28.1)
No. retouched (%)*	3		6	25 (10)				34 (9.9)

\* Percentage excludes chips

## APPENDIX 4 ENVIRONMENTAL DATA

## Summary of the charred plant remains

Sample No	Context No	Flot vol (ml)	Type of context, phasing and spot dating	Charcoal	Grain	Chaff	Weeds	Other charred	Vol floated (litres)	Notes
1	8403	40	Tertiary fill of ditch MR	++ <i>Quercus</i> sp (oak) present	+	+	+		30	Modern plant matter present
2	8503	90	Stone spread LPREH	++++ <i>Fraxinus excelsior</i> (ash), <i>Quercus</i> sp + Diffuse porous including Maloideae (good condition)					40	Modern plant matter present
3	8407	10	Secondary fill of pit MR	+ <i>Quercus</i> sp present					40	Modern plant matter present
4	8412	40	Homogenous fill of ditch MR	++ Malodiae present	+ <i>Triticum</i> sp., <i>Hordeum</i> sp				40	Modern plant matter present
5	8412		Homogenous fill of ditch MR						5	
6	7003	90		++ <i>Quercus</i> sp + Malodiae (poor condition)	+ <i>Hordeum</i> sp., <i>Triticum</i> sp.				40	Modern plant matter present
7	5220	15	Fill of ditch 13th C	++ Diffuse porous spp. Including Maloideae/ <i>Prunus</i>				+ <i>Corylus avellana</i> , +	40	
8	4203	15	Buried soil/colluvium Undated						40	All modern plant matter present
9	7505	50	Fill of ditch L11thC	+	+ <i>Triticum</i> sp.				40	Modern plant matter present. Feature noted as waterlogged but no evidence in sample
10	4807	100	Fill of terrace/ditch L11thC	+	++++ <i>Triticum</i> sp.				40	90% vol modern plant matter present
11	165	10	Fill of ditch 105 LIA		+ <i>Hordeum</i> , + Gramineae, + <i>Triticum</i> spp.?	+ ?culm node	++		40	90% vol modern plant matter present

Sample No	Context No	Flot vol (ml)	Type of context, phasing and spot dating	Charcoal	Grain	Chaff	Weeds	Other charred	Vol floated (litres)	Notes
12	164	19	Secondary fill of ditch 105 LIA		+ <i>Triticum</i> sp., <i>Hordeum</i> sp.	+ glume base, +? Rachis	+ Comp ositae		40	90% vol modern plant matter present
13	2905	240	Fill of pit 2904	++++ good preservation of >4mm, including diffuse porous Maloideae/Prunus	++				40	
14	1707	270	Fill of Ditch 1705 MBA	++++ good preservaiton of >4mm, including <i>Quercus</i> sp, <i>Fraxinus excelsior</i> (ash) and diffuse porous including Maloideae/Prunus	++	?+	++ inc Galium	+? <i>Corylus avellana</i>	40	Fired clay with plant impressions in sample
15	3003	80	250-410 AD occupation spread 3003 LR0	+			+ ? <i>Sambuca niger</i> , <i>Chenopodium</i> spp., <i>Rumex</i> , ++ <i>Polygonum</i> <i>?persicaria</i>		40	Was this once waterlogged?

Key: +=present (up to 5 items), +=frequent (5-25), +=common (25-100) +=+=abundant (>100)



**APPENDIX 5 CERAMIC BUILDING MATERIAL (CBM)***Quantification by context*

<i>Context</i>	<i>Tile type</i>	<i>Thick ness</i>	<i>No.of frags</i>	<i>Weight</i>	<i>Date</i>
1202	Misc	-	1	10g	Roman
3000	Tegula flange (flange height 45mm)	17mm	1	107g	Roman
3000	Tegula flange	17mm	1	92g	Roman
3000	Misc	-	1	37g	Roman
3000	Box flue tile fragment with combing on upper surface	17mm	1	135g	Roman
3000	Box flue tile fragment with combing on upper surface	20mm	1	93g	Roman
3000	Plain tile	20mm	1	130g	Roman
3000	Misc	-	4	55g	Roman
3000	Misc	-	2	229g	Modern
3000	Plain tile	11mm	1	51g	Medieval/Post Medieval
3000	Misc	-	1	11g	Post Roman
3000	Peg tile with traces of a nail hole in one edge	14mm	1	45g	Medieval/Post Medieval
3000	Misc	-	4	57g	Roman
3008	Box flue tile fragment with combing on upper surface	16mm	1	22g	Roman
3100	Roof tile	10mm	1	20g	Medieval/Post Medieval
3110	Box flue tile fragment with combing on the upper surface	17mm	1	114g	Roman
3110	Misc	-	3	15g	Roman
3207	Plain tile	35mm	2	255g	Roman

**APPENDIX 6 BIBLIOGRAPHY AND REFERENCES**

Air Photo Services, 2004, Swindon Gateway, aerial photographic assessment

Corney, M. and Morris, N. 2004, Badbury Wick SMV, Swindon Gateway, an analytical earthwork survey (unpublished report 10/04)

Corney, M. and Morris, N. 2005, Day House Lane, Swindon Gateway, an analytical earthwork survey (unpublished report: 03/05)

English Heritage (2002) Environmental Archaeology, a guide to the theory and practice of methods, from sampling and recovery to post-excavation. Centre for Archaeology Guidelines.

Gover, J.E.B., Mawer, A, and Stenton, F.M. 1939, The place names of Wiltshire, Cambridge, Cambridge University Press, 1929 rep.

JSAC 2003, An archaeological desk-based assessment of the proposed Swindon Gateway, Coate, Swindon, Wiltshire, 1082/03/01

JSAC 2005, Specification for archaeological trial trenching at Swindon Gateway, 1082/2005

Oxford Archaeology, 1992, Field Manual (ed. D. Wilkinson)

Oxford Archaeology (2000) Oxford Archaeology Environmental Sampling Guidelines. Internal Document.

Pre-Construct Geophysics 2005, Geophysical survey: site of the proposed Swindon Gateway Development, Coate, Swindon, Wiltshire

### **Bibliography for Lithics Reports**

Bamford, H M, 1985 *Briar Hill excavation 1974-1978*, Northampton Development Control Archaeol. Mono **3**, Northampton

Benson, D and Whittle, A W R, Forthcoming *Building Memories: the Neolithic Cotswold Long Barrow at Ascott-under-Wychwood, Oxfordshire*, Oxbow Books for English Heritage, Oxford

Bradley, P, 1999 Worked flint in A Barclay and C Halpin *Excavations at Barrow Hills, Radley, Oxfordshire. Volume 1 The Neolithic and Bronze Age monument complex*, Thames Valley Landscapes Volume **11**, Oxford, 211-277

Brittnell, W J, 1984 The Gwernvale long cairn, Crickhowell. In W J Brittnell and H N Savory Eds. *Gwernvale and Penywyrllod: two Neolithic long cairns in the Black Mountains of Brecknock, Bangor, Gwynedd*, Cambrian Archaeological Association, Cambrian Archaeological Monographs **2**, 41-154

Ford, S, 1987 Chronological and functional aspects of flint assemblages, in Brown, A G and Edmonds, M R, (eds) *Lithic analysis and later British prehistory*, BAR Brit Ser **162**, Oxford, 67-81

Green, S H, 1980 *Flint arrowheads of the British Isles: a detailed study of material from England and Wales with comparanda from Scotland and Ireland*, Part 1, BAR Brit Ser **75(i)** Oxford

Healy, F, 1988 *The Anglo-Saxon cemetery at Spong Hill, North Elmham, part VI: Occupation in the seventh to second millennia BC*, E Anglian Archaeol. **39**, Gressenhall

Holgate, R, 1988 *Neolithic settlement of the Thames valley*. BAR Brit Ser **194**, Oxford

Jacobi, R, 1978 The Mesolithic of Sussex, in Drewett, P L (ed.), *Archaeology in Sussex to AD 1500*, CBA Res Rep **29**, 15-22

Moss, E H, 1983 Some comments on edge damage as a factor in functional analysis of stone artefacts, *J Archaeol Sci* **10**, 231-242

Saville, A, 1990 *Hazelton North, Gloucestershire 1979-82: the excavation of a Neolithic long cairn of the Cotswold-Severn group*, London: English Heritage

Schofield, J, 2000 *Managing lithic scatters: Archaeological guidance for planning authorities and developers*, English Heritage, London

Thomas, J, 1999 *Understanding the Neolithic*, Routledge, London

### **Bibliography for Pottery Reports**

Booth, P, *Oxford Archaeology Roman pottery recording system*, Oxford Archaeology, unpublished (revised January 2006)

Davies, B, Richardson, B and Tomber, R 1994 *A dated corpus of early Roman pottery from the City of London*, CBA RE Rep **98**, London

McCarthy, MR and Brooks, CM, 1988 *Medieval Pottery in Britain AD900-1600* Leicester University Press

Mephram, 1997 Pottery in Vince AG, Lobb, SJ, Richards JC and Mephram, L *Excavations in Newbury, Berkshire, 1979 □1990* Wessex Archaeol Rep **13**, 45-67

Vince, AG, 1984 Late Saxon and Medieval Pottery in Gloucestershire in A Saville (ed.) *Archaeology in Gloucestershire: Essays Dedicated to Helen O'Neill and the Late Elsie Clifford*, 248 - 75

Vince, AG, unpub. *The Medieval Ceramic Industry of the Severn Valley* Unpublished PhD Thesis, University of Southampton, 1984

## **APPENDIX 7 SUMMARY OF SITE DETAILS**

**Site name:** Swindon Gateway

**Site code:** B/2005/14

**Grid reference:** SU 1580 8150

**Type of evaluation:** Evaluation of 160 hectares of farmland. 83 evaluation trenches were dug measuring 50 m by 2 m, and one trench of 100 m by 2 m. In addition, fieldwalking (surface artefact collection) was undertaken across a 20 hectare field in the north-west of the area.

**Date and duration of project:** 28/11/05-22/12/05 and 13/2/06-10/03/06, 43 days

**Area of site:** 160 hectares

**Summary of results:** The evaluation trenches revealed several areas of well-preserved archaeological remains of many periods, including Bronze Age, Iron Age, Roman and Medieval. In total 315 features were identified, 128 of which can be dated by pottery. In addition, fieldwalking survey in the north-west of the area recovered almost 2,000 pieces of flint and defined two concentrations of lithic material dating from the late Mesolithic and the early Bronze Age.

**Location of archive:** The archive is currently held at OA, Janus House, Osney Mead, Oxford, OX2 0ES, and will be deposited with Wiltshire County Museums Service in due course. The accession number is yet to be issued.





Scale 1:50,000

Reproduced from the Explorer 1:25,000 scale by permission of the Ordnance Survey on behalf of The Controller of Her Majesty's Stationery Office © Crown Copyright 1998. All rights reserved. Licence No. AL 10005569

Figure 1: Site location



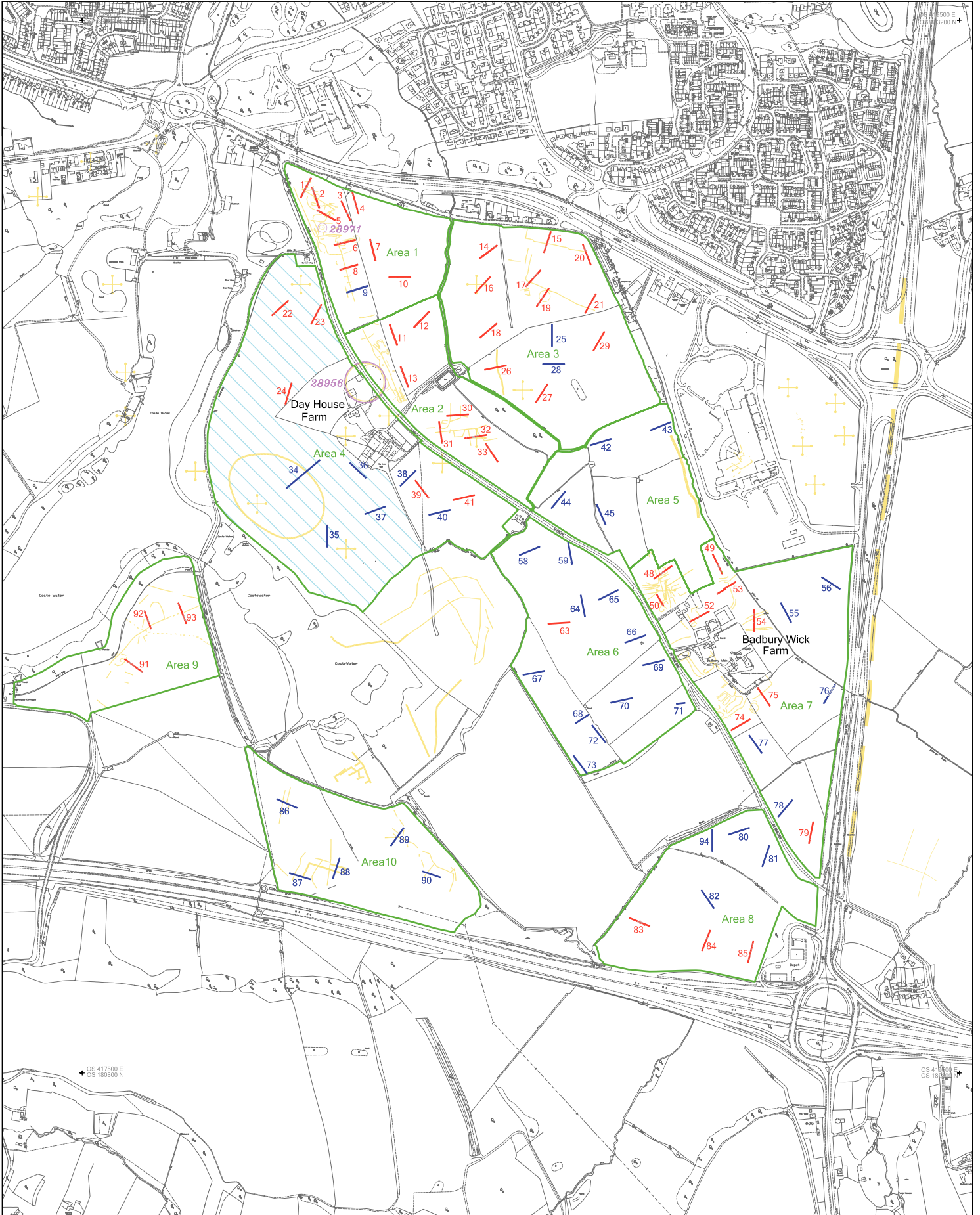

- Trench with archaeological features
- Trench with no archaeological features
- Area of fieldwalking survey

- os basemap
- SMR archaeology
- Area boundary
- Scheduled Ancient Monument

Oxford Archaeology  
 Janus House,  
 Osney Mead,  
 Oxford,  
 OX2 0ES.  
 Tel: 01865 263800 Fax: 01865 793496  
 email: mail@oxfordarch.co.uk  
 web: www.oxfordarch.co.uk

SWINDON GATEWAY

Drawing No.	DG_TR_11.11.05
Date printed	06.12.05
Drawing title	

Figure 2:  
 Distribution of areas  
 and trench locations

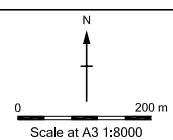

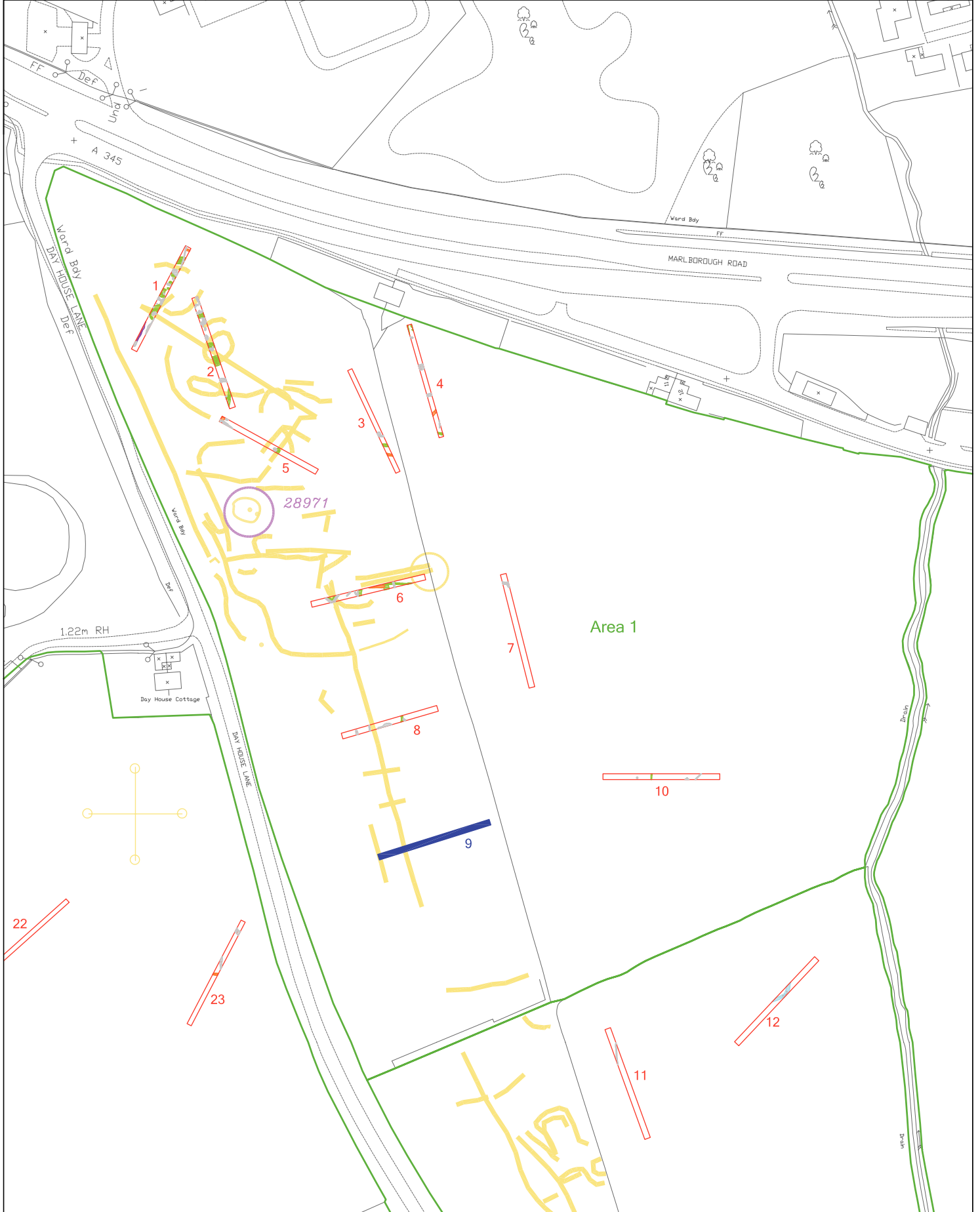

Archaeological features by date

- Unknown date
- Late Prehistoric
- Middle Bronze Age
- Roman
- Early medieval
- Post medieval

- Trench with archaeological features
- Trench with no archaeological features

- os basemap
- SMR archaeology
- Area boundary
- Scheduled Ancient Monument

Oxford Archaeology  
 Janus House,  
 Osney Mead,  
 Oxford,  
 OX2 0ES.  
 Tel: 01865 263800 Fax: 01865 793496  
 email: mail@oxfordarch.co.uk  
 web: www.oxfordarch.co.uk

SWINDON GATEWAY

Drawing No.	DG_TR_11.11.05
Date printed	23.11.05
Drawing title	

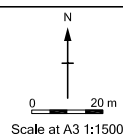
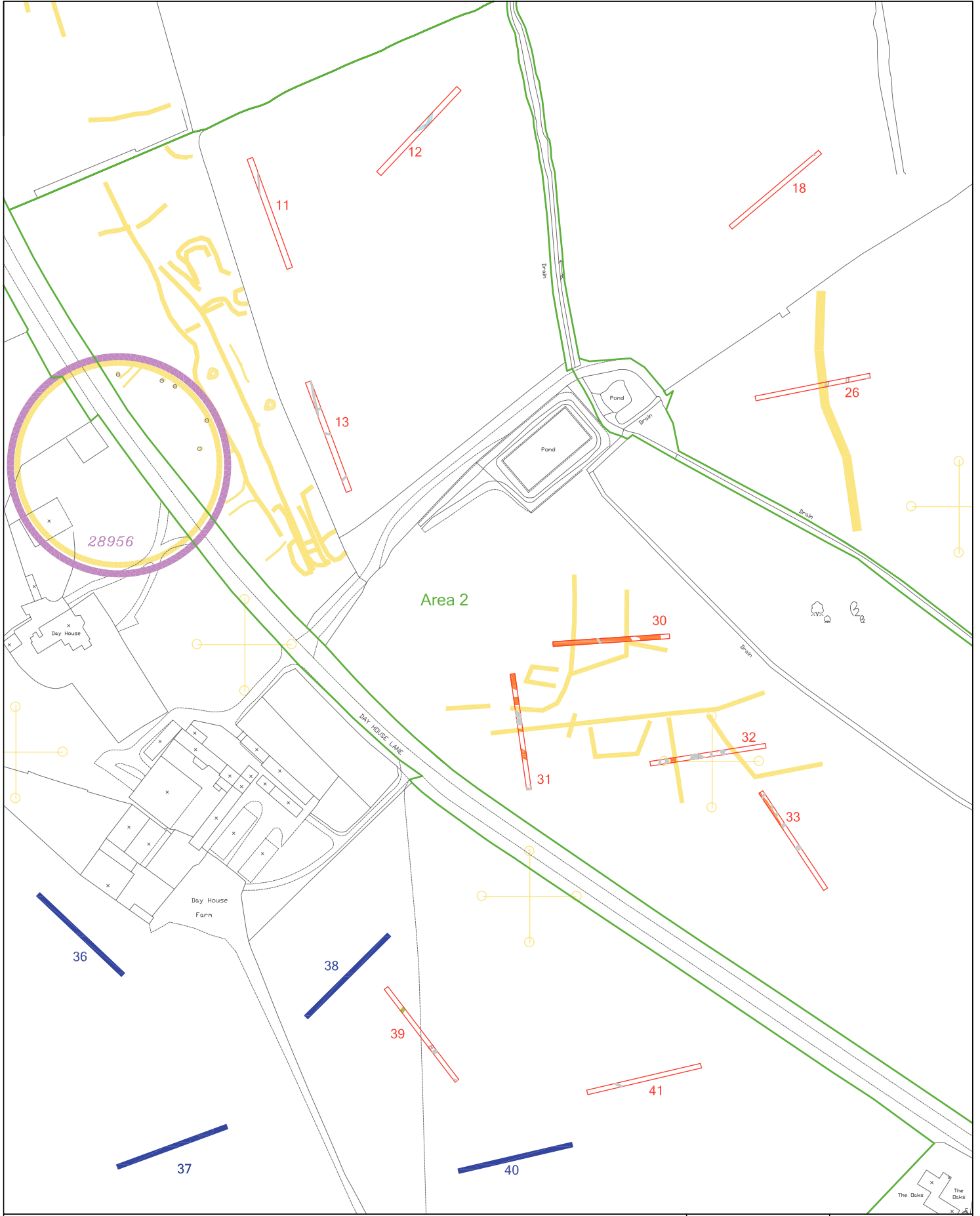

Figure 3:  
Area 1

CHECKED BY: LMIMB



Archaeological features by date

- Unknown date
- Late Prehistoric
- Middle Bronze Age
- Roman
- Early medieval
- Post medieval

- Trench with archaeological features
- Trench with no archaeological features

- os basemap
- SMR archaeology
- Area boundary
- Scheduled Ancient Monument

Oxford Archaeology  
 Janus House,  
 Osney Mead,  
 Oxford,  
 OX2 0ES.  
 Tel: 01865 263800 Fax: 01865 793496  
 email: mail@oxfordarch.co.uk  
 web: www.oxfordarch.co.uk

SWINDON GATEWAY

Drawing No.	DG_TR_11.11.05
Date printed	23.11.05
Drawing title	

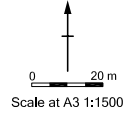
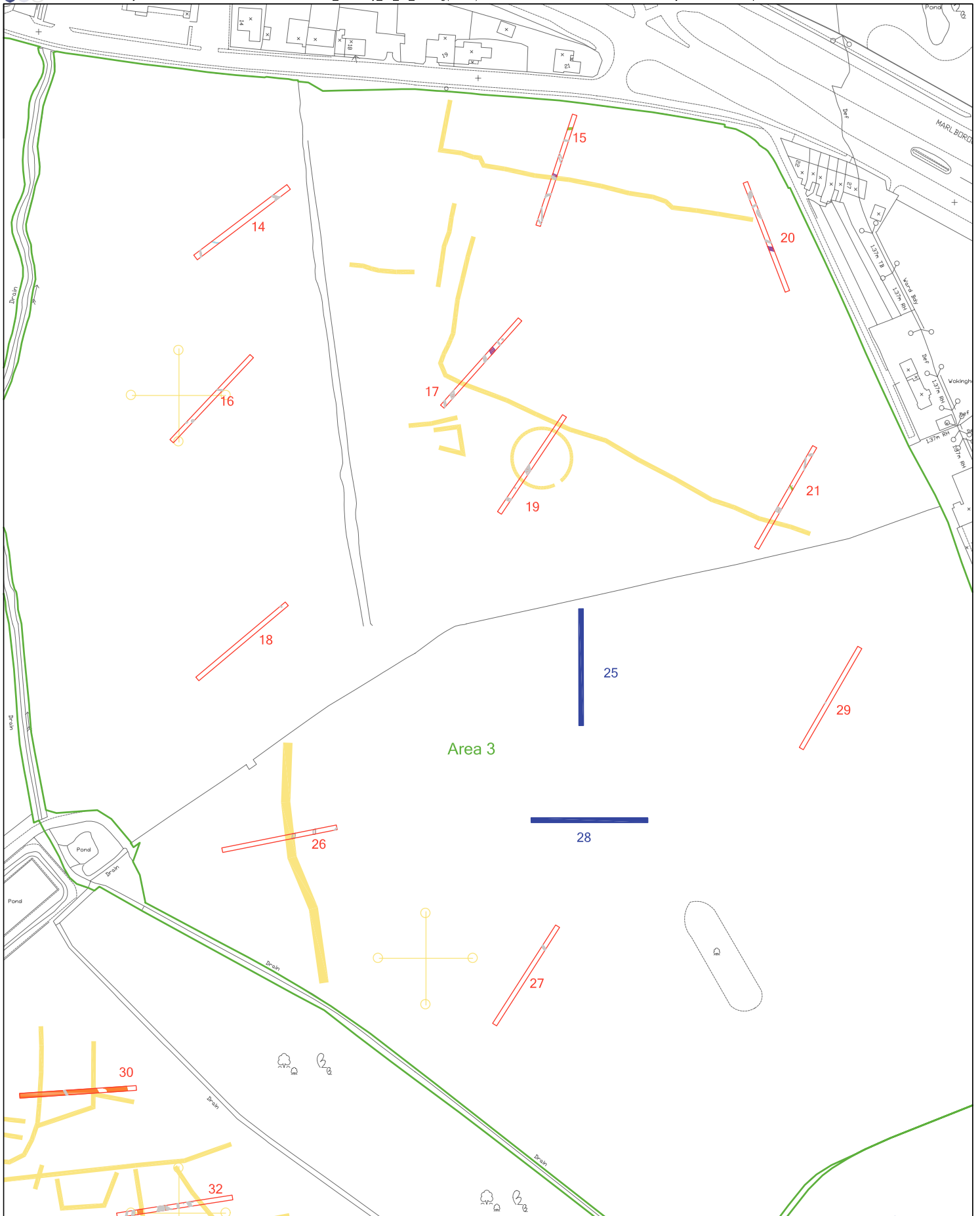

Figure 4:  
Area 2

CHECKED BY: LMIMB





Archaeological features by date

- Unknown date
- Late Prehistoric
- Middle Bronze Age
- Roman
- Early medieval
- Post medieval

- Trench with archaeological features
- Trench with no archaeological features

- os basemap
- SMR archaeology
- Area boundary
- Scheduled Ancient Monument

Oxford Archaeology  
 Janus House,  
 Osney Mead,  
 Oxford,  
 OX2 0ES.  
 Tel: 01865 263800 Fax: 01865 793496  
 email: mail@oxfordarch.co.uk  
 web: www.oxfordarch.co.uk

SWINDON GATEWAY

Drawing No.	DG_TR_11.11.05
Date printed	23.11.05
Drawing title	

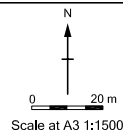
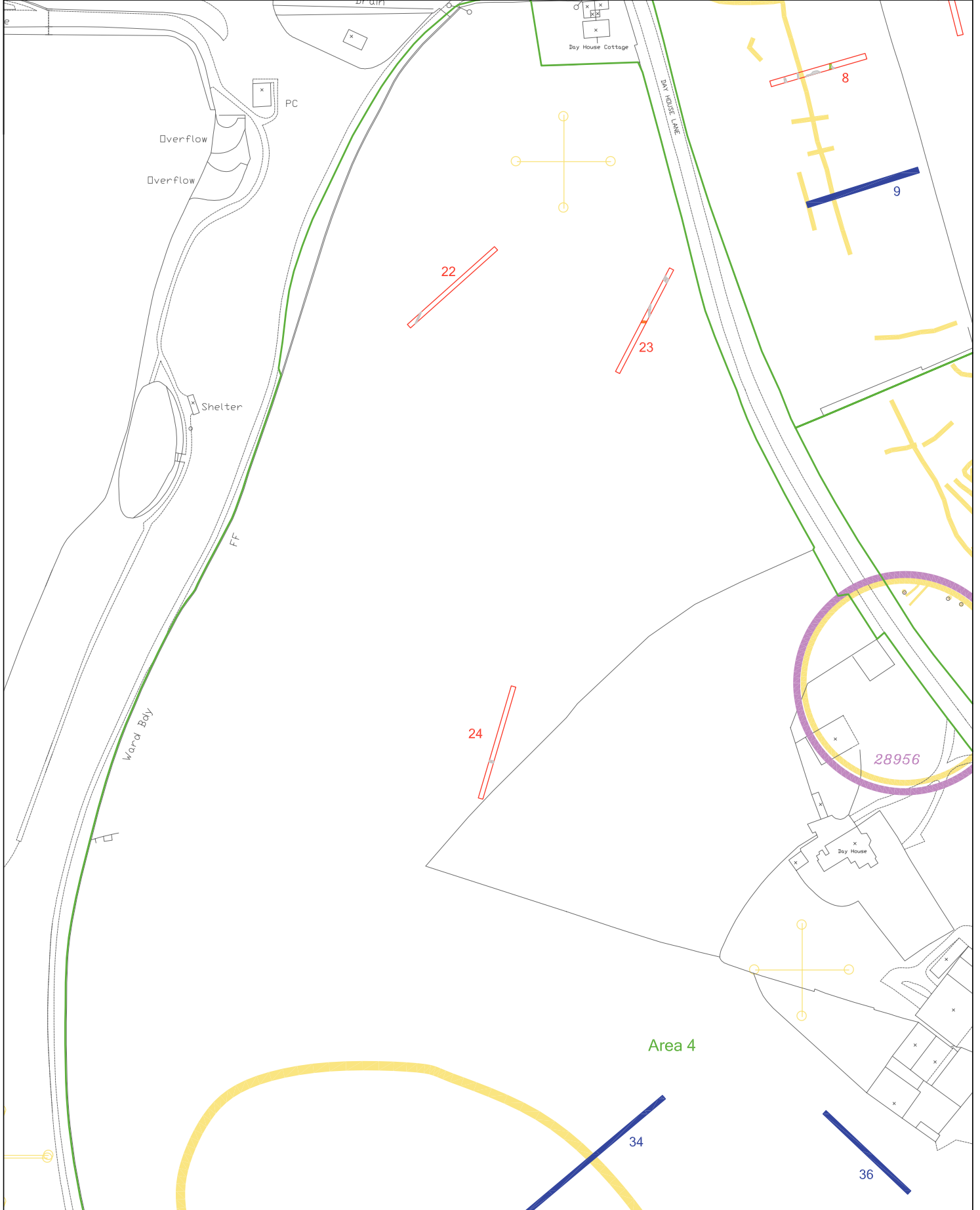

Figure 5:  
Area 3



Archaeological features by date

- Unknown date
- Late Prehistoric
- Middle Bronze Age
- Roman
- Early medieval
- Post medieval

- Trench with archaeological features
- Trench with no archaeological features

- os basemap
- SMR archaeology
- Area boundary
- Scheduled Ancient Monument

Oxford Archaeology  
 Janus House,  
 Osney Mead,  
 Oxford,  
 OX2 0ES.  
 Tel: 01865 263800 Fax: 01865 793496  
 email: mail@oxfordarch.co.uk  
 web: www.oxfordarch.co.uk

SWINDON GATEWAY

Drawing No.	DG_TR_11.11.05
Date printed	23.11.05
Drawing title	

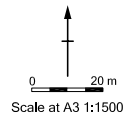
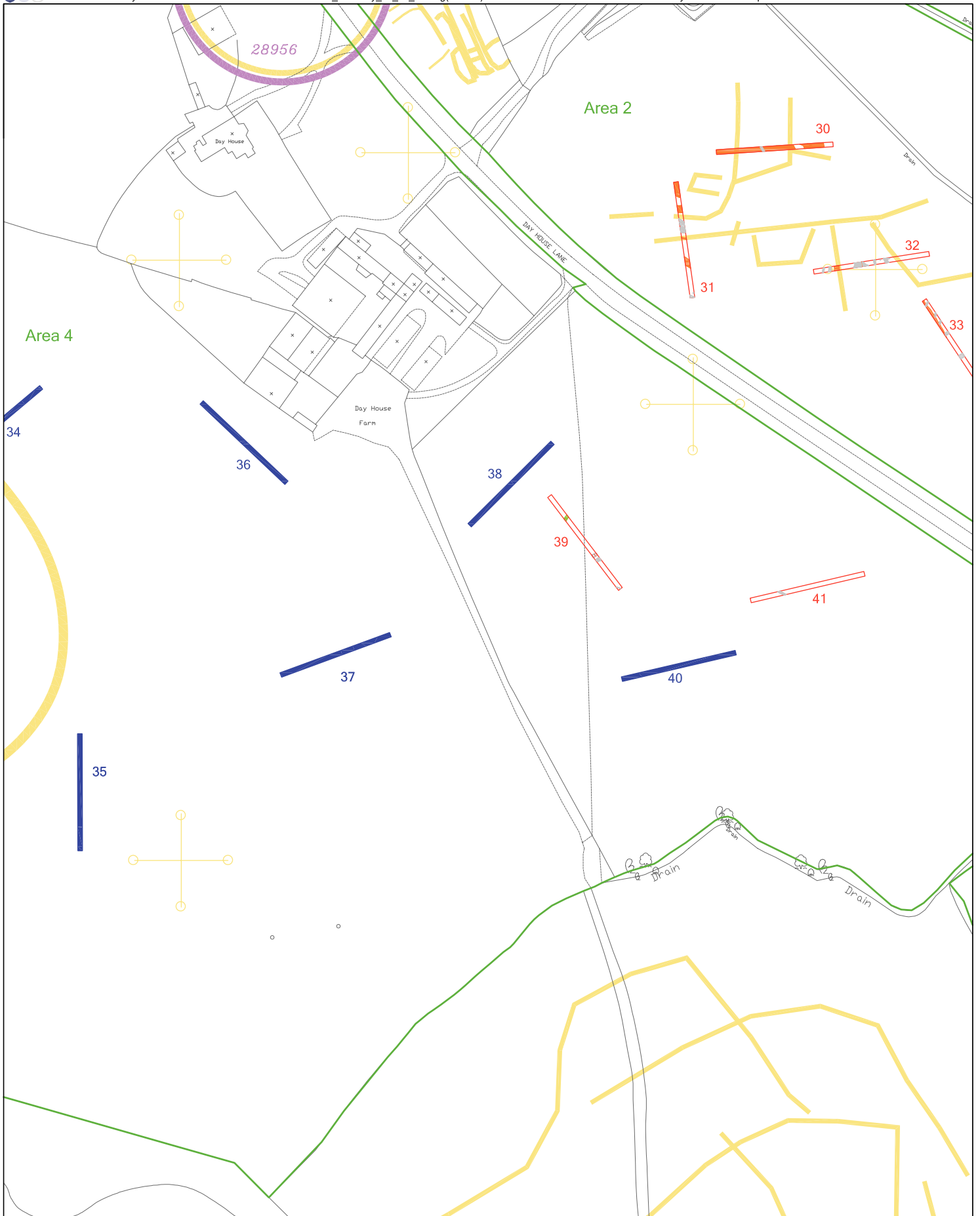

Figure 6:  
Area 4 a



Archaeological features by date

- Unknown date
- Late Prehistoric
- Middle Bronze Age
- Roman
- Early medieval
- Post medieval

- Trench with archaeological features
- Trench with no archaeological features

- os basemap
- SMR archaeology
- Area boundary
- Scheduled Ancient Monument

Oxford Archaeology  
 Janus House,  
 Osney Mead,  
 Oxford,  
 OX2 0ES.  
 Tel: 01865 263800 Fax: 01865 793496  
 email: mail@oxfordarch.co.uk  
 web: www.oxfordarch.co.uk

SWINDON GATEWAY

Drawing No.	DG_TR_11.11.05
Date printed	23.11.05
Drawing title	

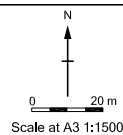
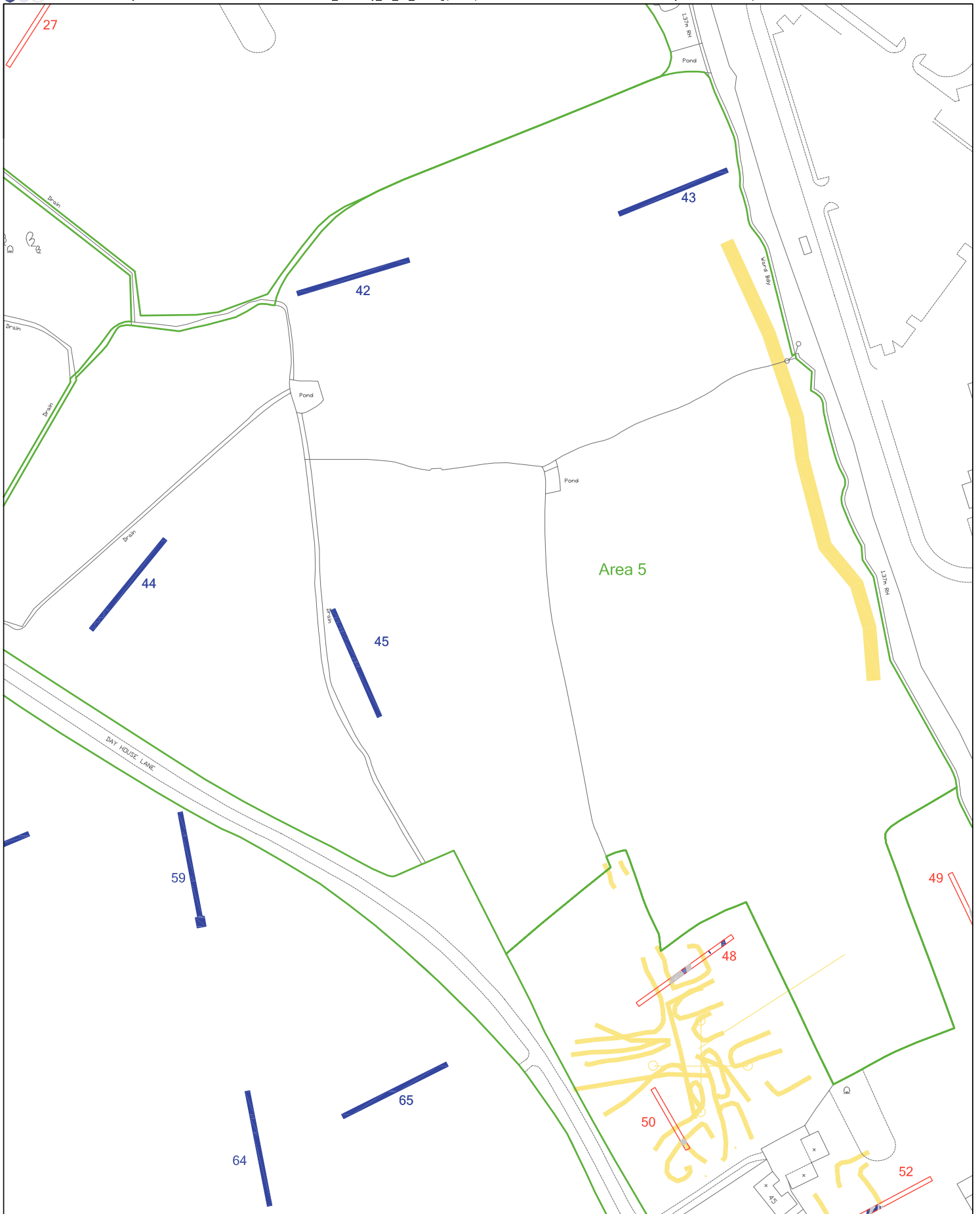

Figure 7:  
Area 4 b

CHECKED BY: LMIMB



Archaeological features by date

- Unknown date
- Late Prehistoric
- Middle Bronze Age
- Roman
- Early medieval
- Post medieval

- Trench with archaeological features
- Trench with no archaeological features

- os basemap
- SMR archaeology
- Area boundary
- Scheduled Ancient Monument

Oxford Archaeology  
 Janus House,  
 Osney Mead,  
 Oxford,  
 OX2 0ES.  
 Tel: 01865 263800 Fax: 01865 793496  
 email: mail@oxfordarch.co.uk  
 web: www.oxfordarch.co.uk

SWINDON GATEWAY

Drawing No.	DG_TR_11.11.05
Date printed	23.11.05
Drawing title	

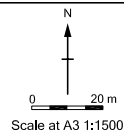
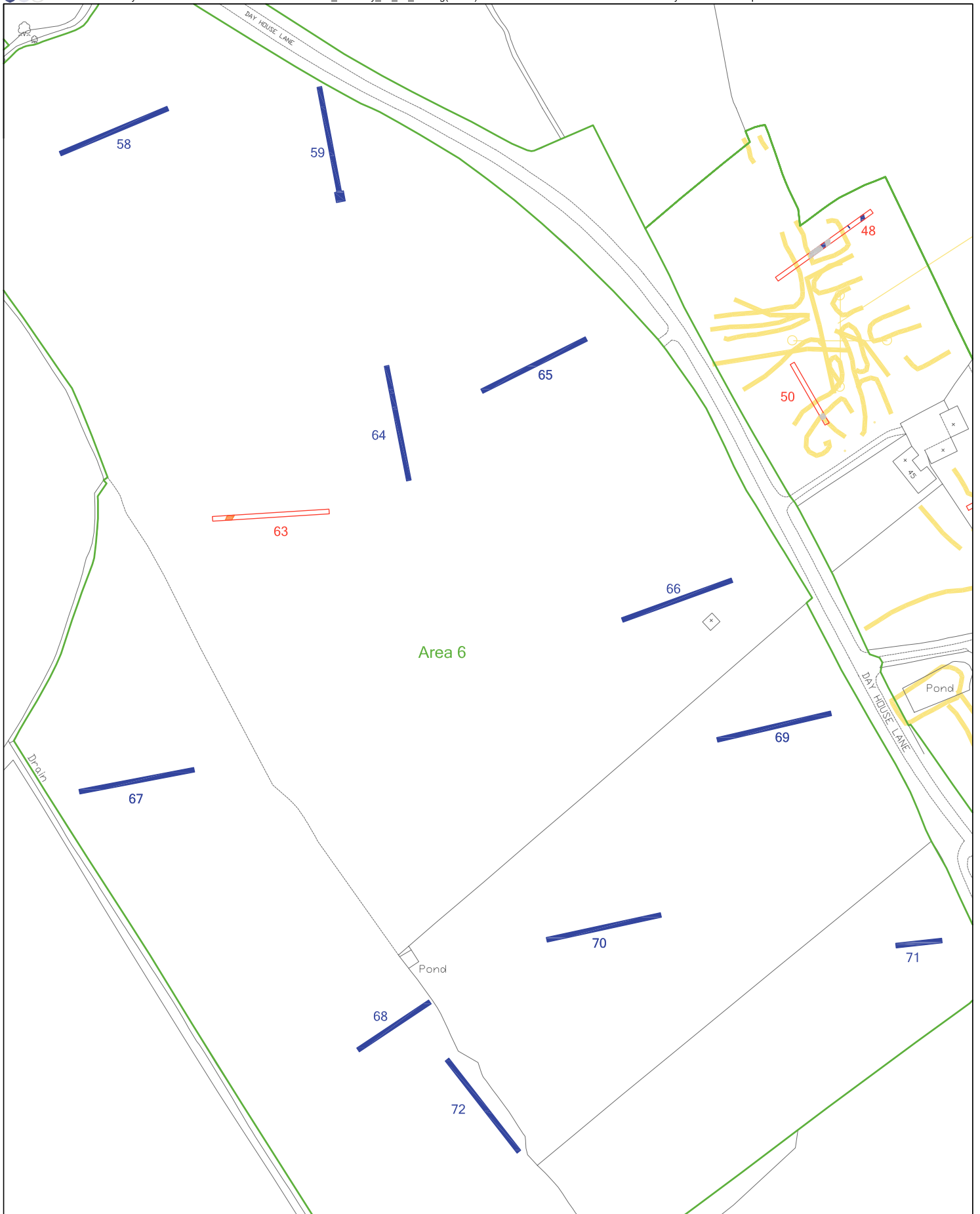

Figure 8:  
Area 5

CHECKED BY: LMIMB



Archaeological features by date

- Unknown date
- Late Prehistoric
- Middle Bronze Age
- Roman
- Early medieval
- Post medieval

- Trench with archaeological features
- Trench with no archaeological features

- os basemap
- SMR archaeology
- Area boundary
- Scheduled Ancient Monument

Oxford Archaeology  
 Janus House,  
 Osney Mead,  
 Oxford,  
 OX2 0ES.  
 Tel: 01865 263800 Fax: 01865 793496  
 email: mail@oxfordarch.co.uk  
 web: www.oxfordarch.co.uk

SWINDON GATEWAY

Drawing No.	DG_TR_11.11.05
Date printed	23.11.05
Drawing title	

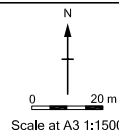
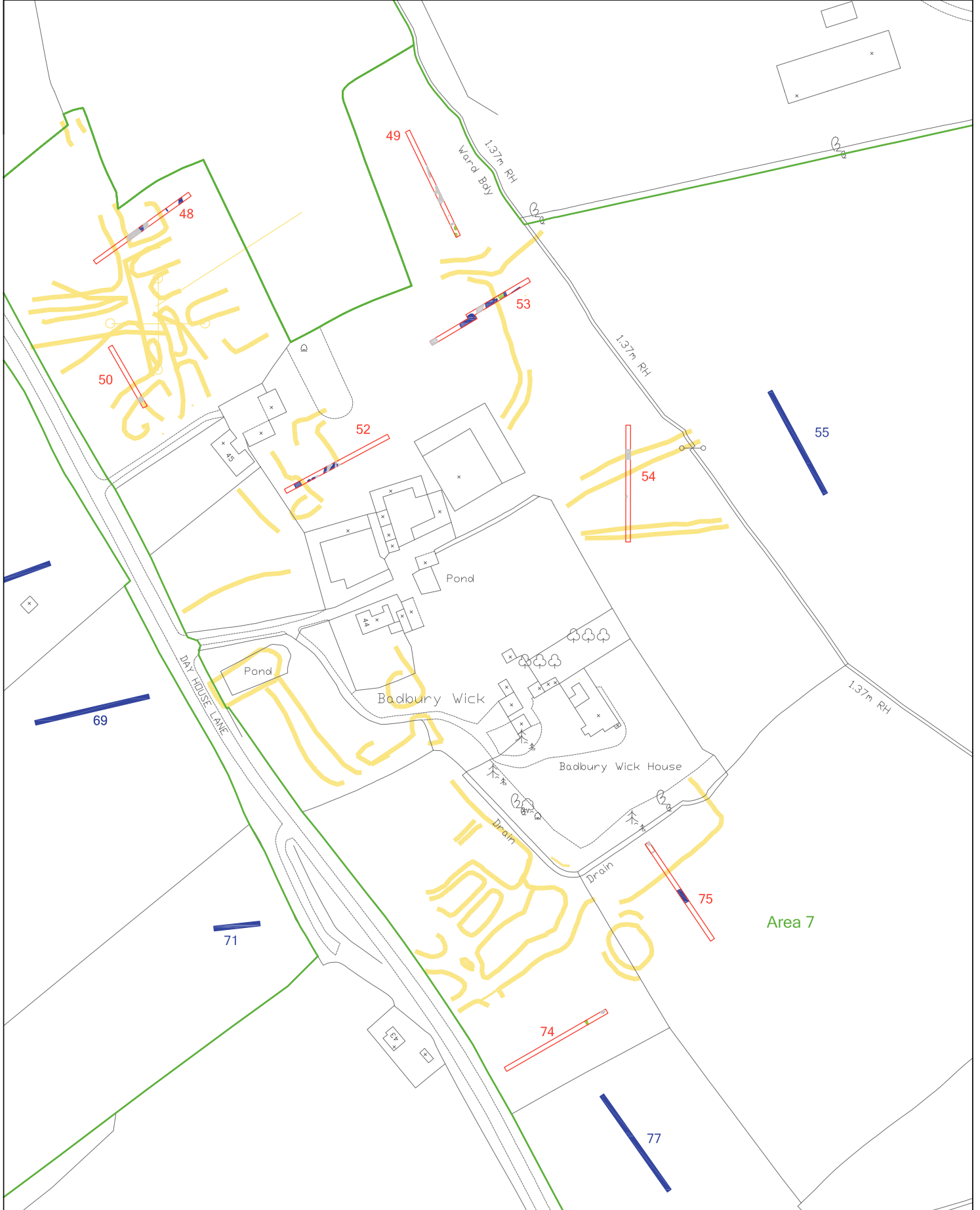

Figure 9:  
Area 6



Archaeological features by date

- Unknown date
- Late Prehistoric
- Middle Bronze Age
- Roman
- Early medieval
- Post medieval

- Trench with archaeological features
- Trench with no archaeological features

- os basemap
- SMR archaeology
- Area boundary
- Scheduled Ancient Monument

Oxford Archaeology  
 Janus House,  
 Osney Mead,  
 Oxford,  
 OX2 0ES.  
 Tel: 01865 263800 Fax: 01865 793496  
 email: mail@oxfordarch.co.uk  
 web: www.oxfordarch.co.uk

SWINDON GATEWAY

Drawing No.	DG_TR_11.11.05
Date printed	23.11.05
Drawing title	

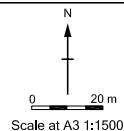
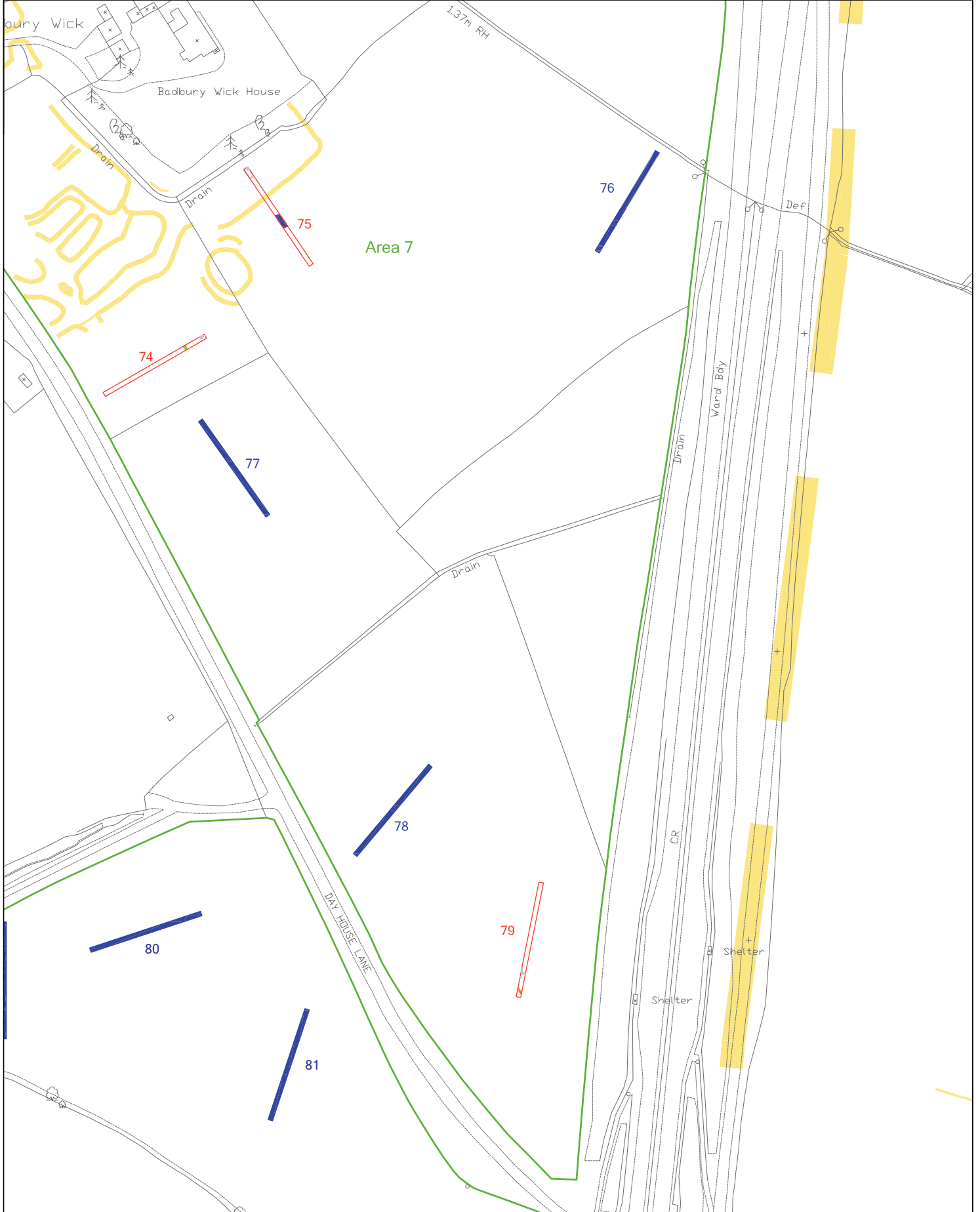

Figure 10:  
Area 7 a



Archaeological features by date

- Unknown date
- Late Prehistoric
- Middle Bronze Age
- Roman
- Early medieval
- Post medieval

- Trench with archaeological features
- Trench with no archaeological features

- os basemap
- SMR archaeology
- Area boundary
- Scheduled Ancient Monument

Oxford Archaeology  
 Janus House,  
 Osney Mead,  
 Oxford,  
 OX2 0ES.  
 Tel: 01865 263800 Fax: 01865 793496  
 email: mail@oxfordarch.co.uk  
 web: www.oxfordarch.co.uk

SWINDON GATEWAY

Drawing No.	DG_TR_11.11.05
Date printed	23.11.05
Drawing title	

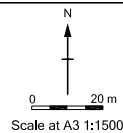
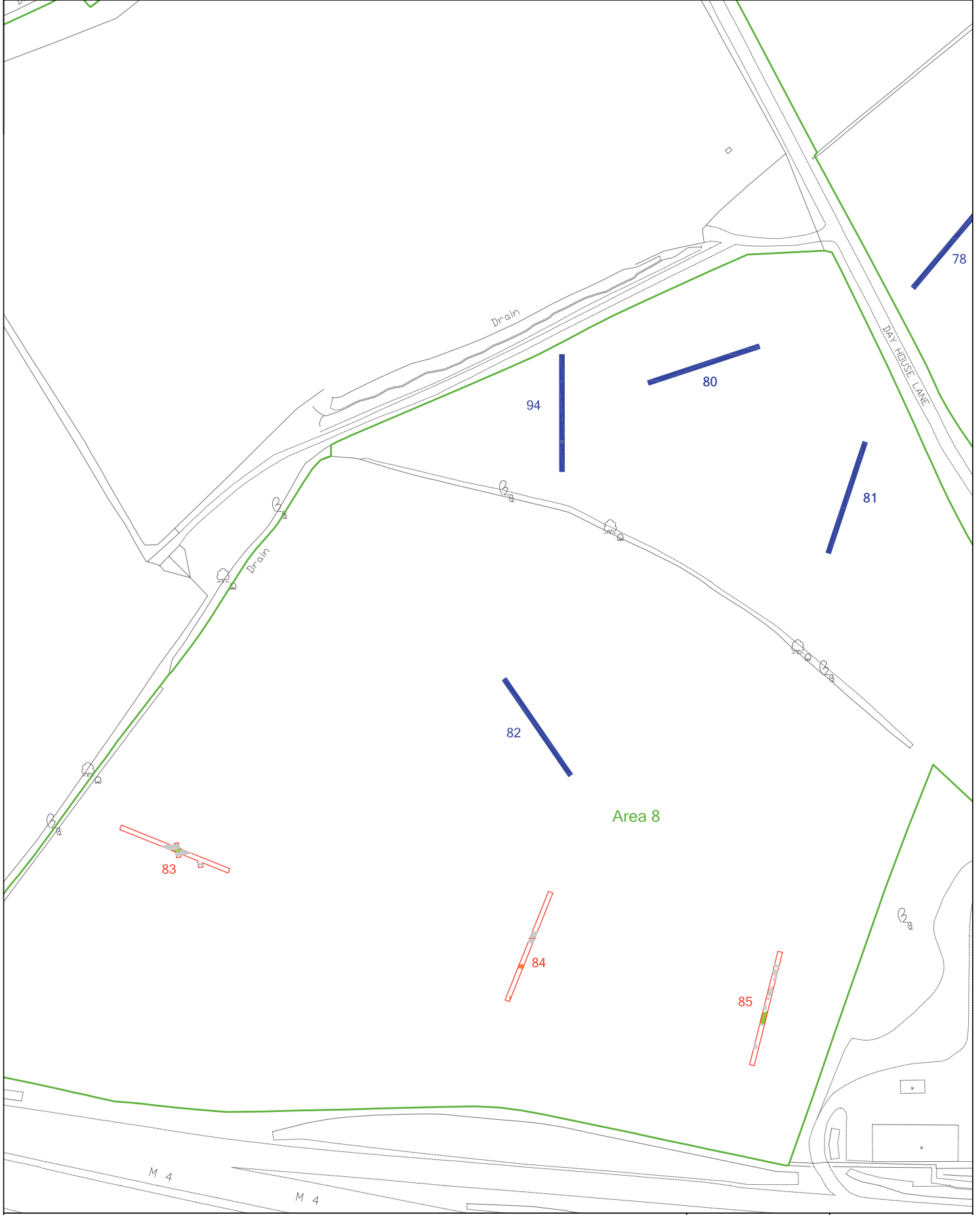

Figure 11:  
Area 7 b





Archaeological features by date

- Unknown date
- Late Prehistoric
- Middle Bronze Age
- Roman
- Early medieval
- Post medieval

- Trench with archaeological features
- Trench with no archaeological features

- os basemap
- SMR archaeology
- Area boundary
- Scheduled Ancient Monument

Oxford Archaeology  
 Janus House,  
 Osney Mead,  
 Oxford,  
 OX2 0ES.  
 Tel: 01865 263800 Fax: 01865 793496  
 email: mail@oxfordarch.co.uk  
 web: www.oxfordarch.co.uk

SWINDON GATEWAY

Drawing No.	DG_TR_11.11.05
Date printed	23.11.05
Drawing title	

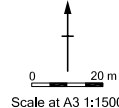

Figure 12:  
Area 8

CHECKED BY: LMIMB





Archaeological features by date

- Unknown date
- Late Prehistoric
- Middle Bronze Age
- Roman
- Early medieval
- Post medieval

- Trench with archaeological features
- Trench with no archaeological features

- os basemap
- SMR archaeology
- Area boundary
- Scheduled Ancient Monument

Oxford Archaeology  
 Janus House,  
 Osney Mead,  
 Oxford,  
 OX2 0ES.  
 Tel: 01865 263800 Fax: 01865 793496  
 email: mail@oxfordarch.co.uk  
 web: www.oxfordarch.co.uk

SWINDON GATEWAY

Drawing No.	DG_TR_11.11.05
Date printed	23.11.05
Drawing title	

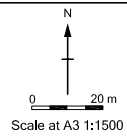
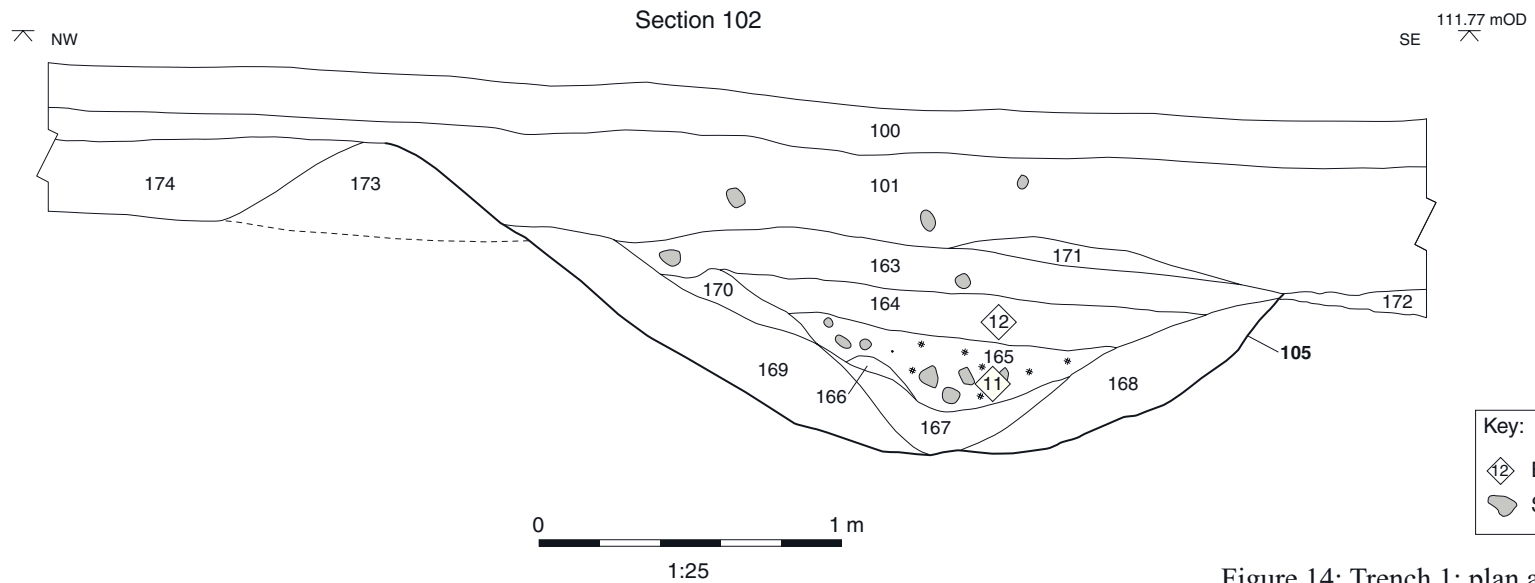
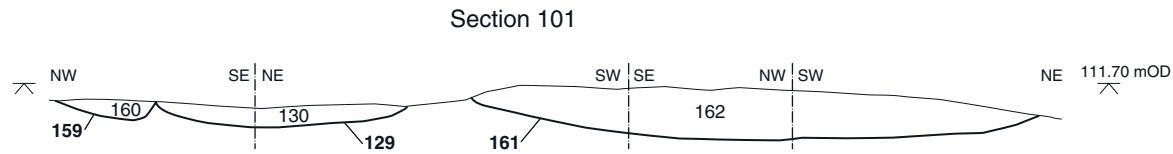
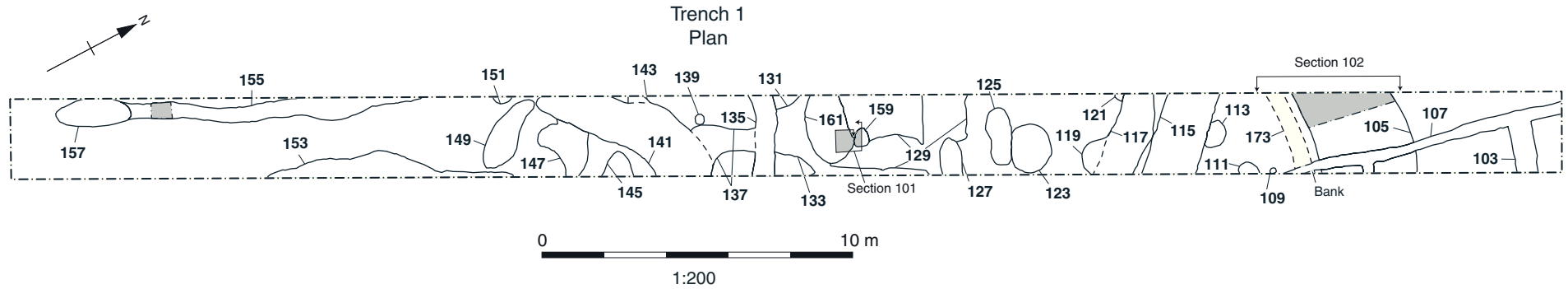

Figure 13:  
Area 9

CHECKED BY: LMMB



Key:

	Environmental sample
	Stone

Figure 14: Trench 1; plan and selected sections

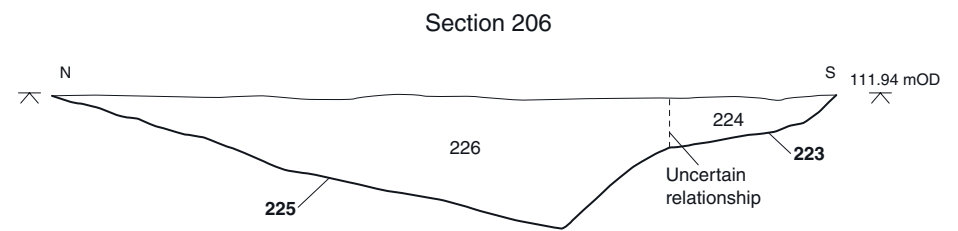
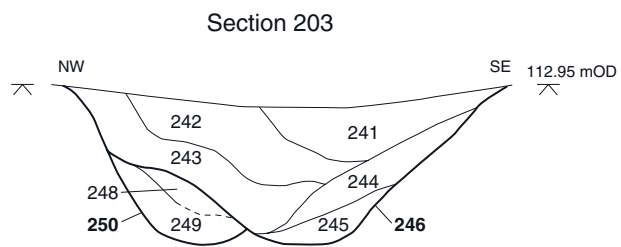
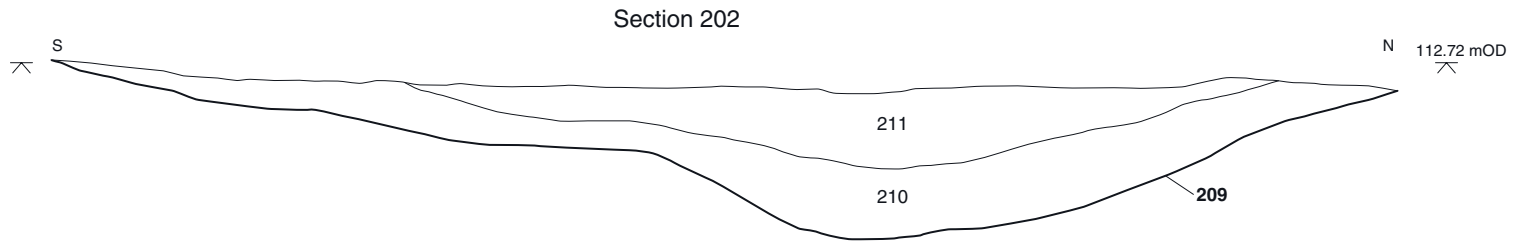
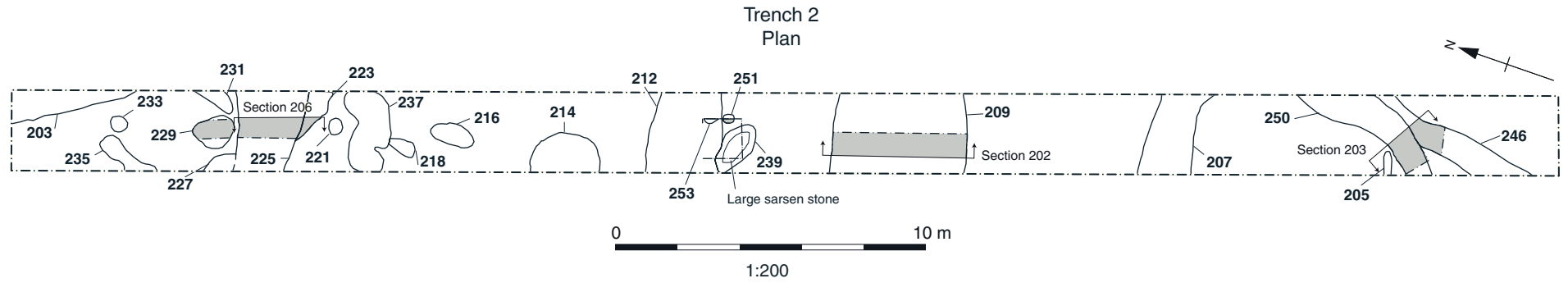

Figure 15: Trench 2; plan and selected sections

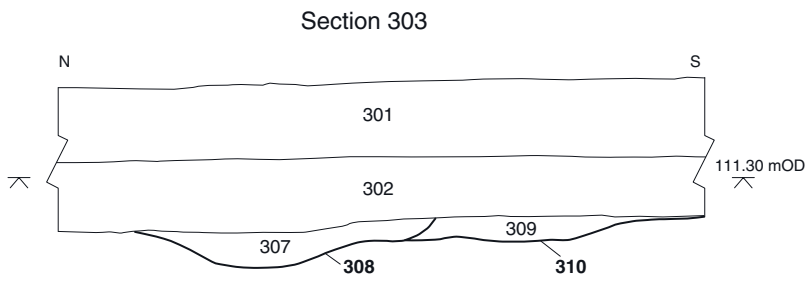
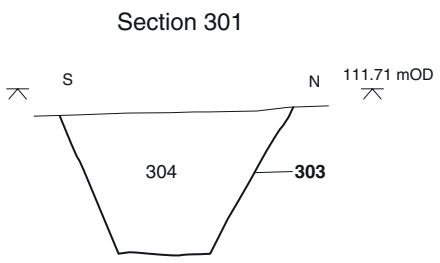
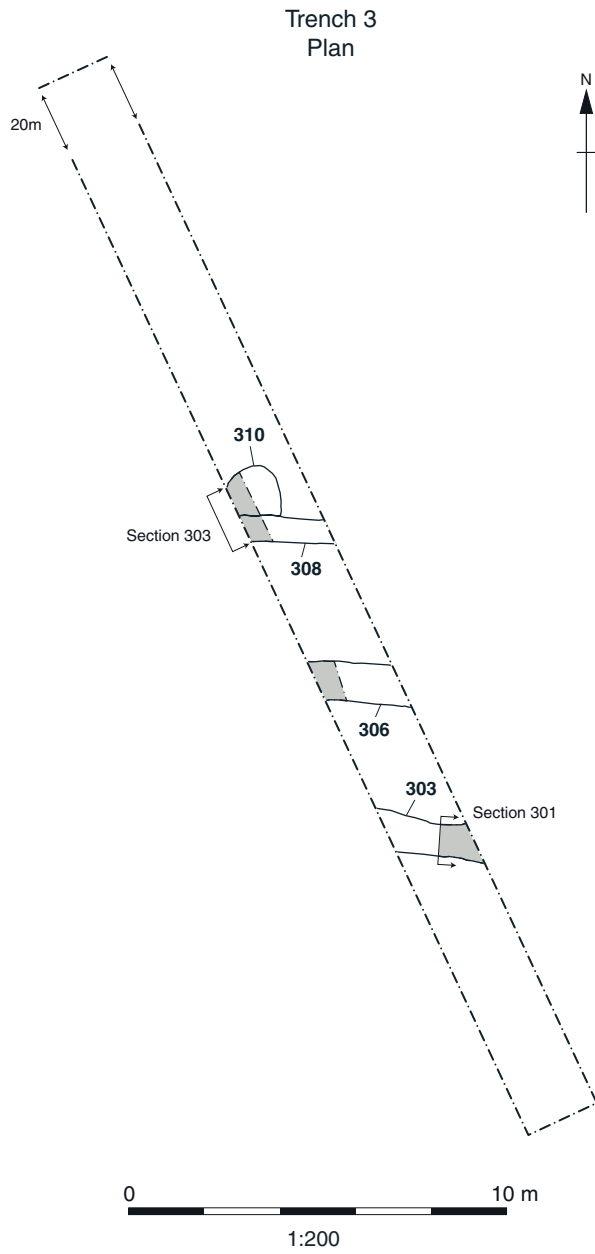

Figure 16: Trench 3; plan and selected sections

### Trench 4 Plan

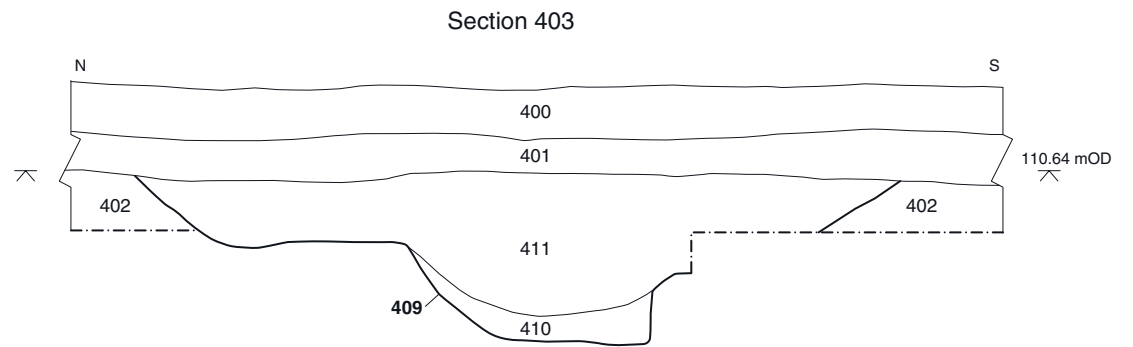
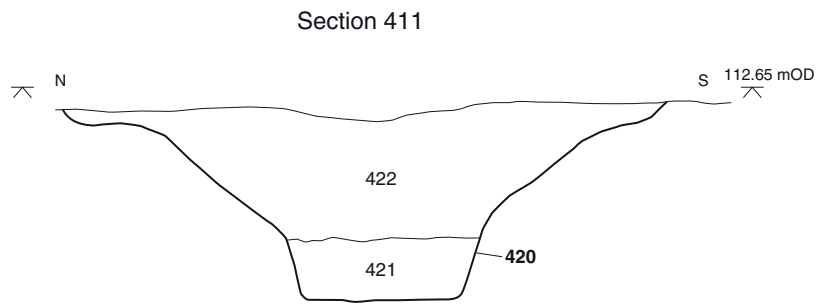
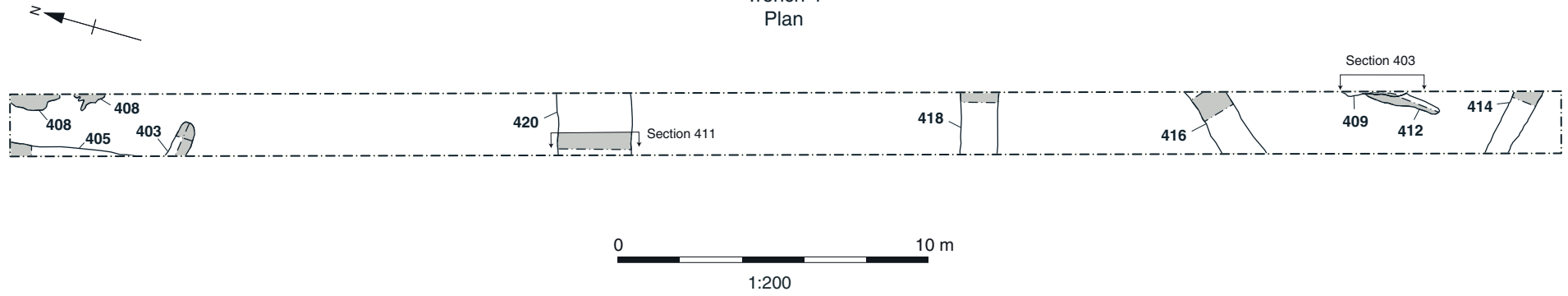

Figure 17: Trench 4; plan and selected sections

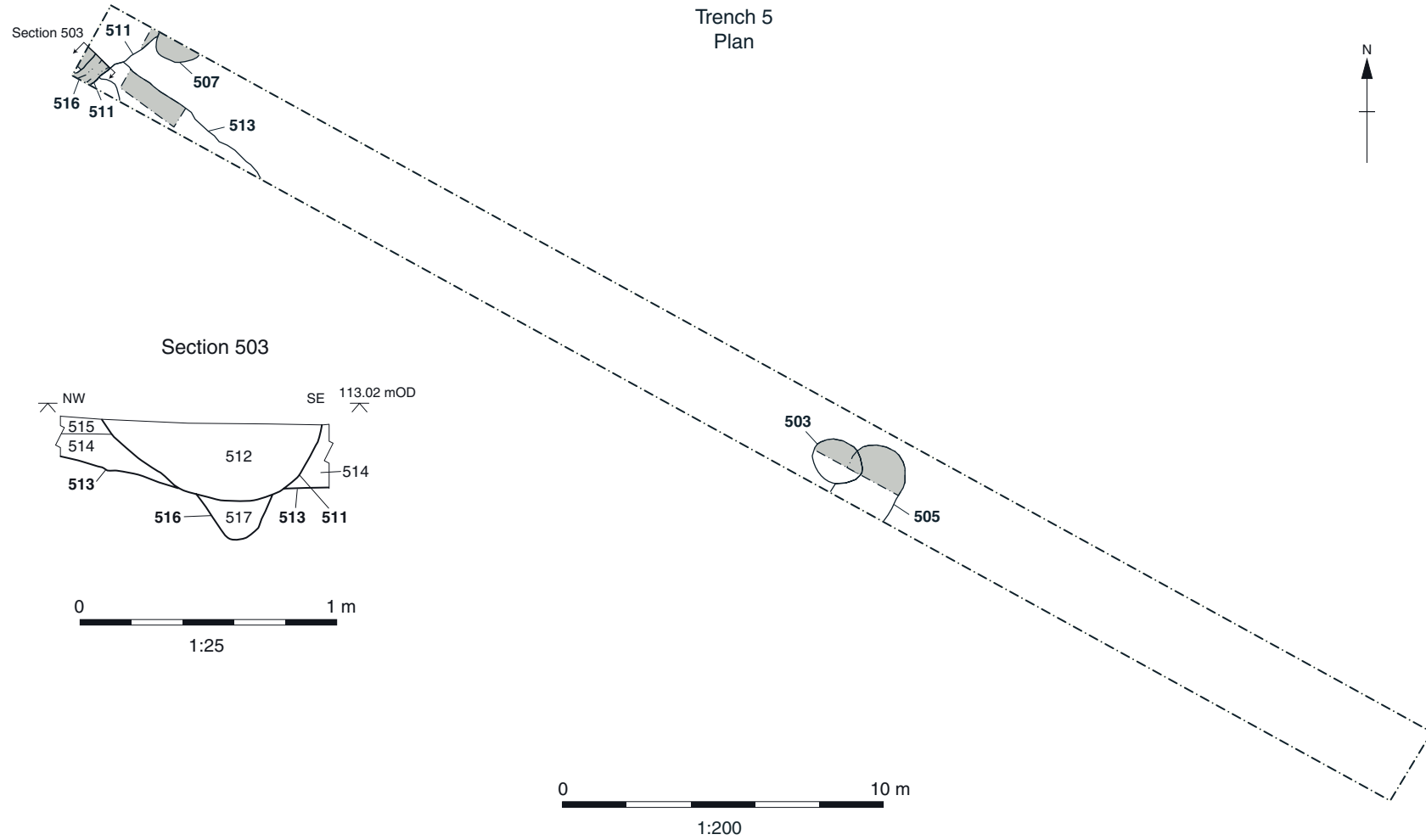

Figure 18: Trench 5; plan and selected section

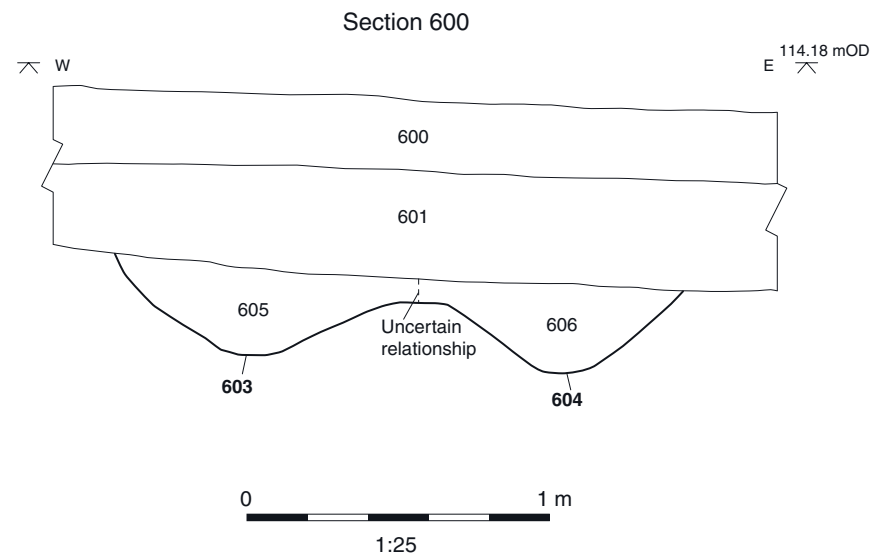
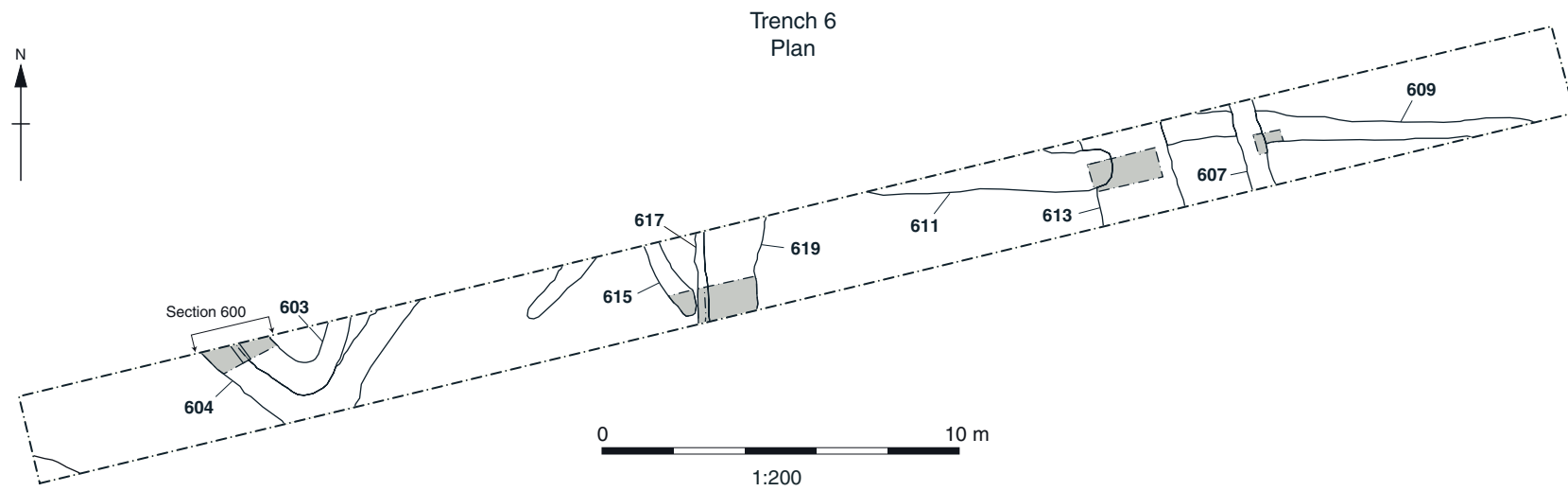

Figure 19: Trench 6; plan and selected section

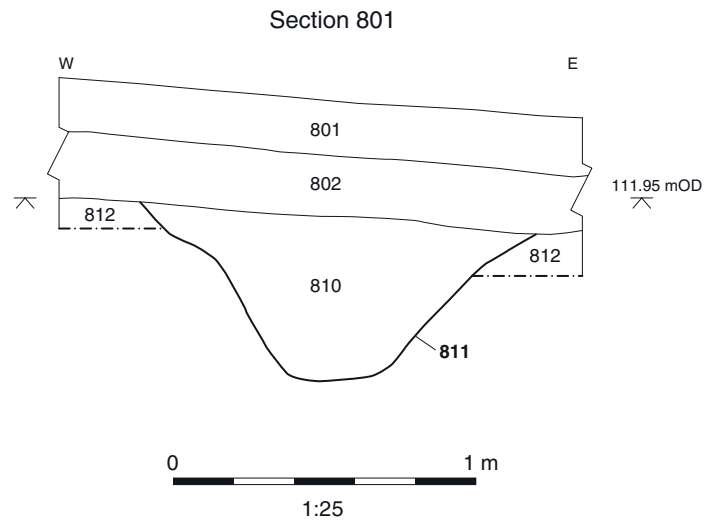
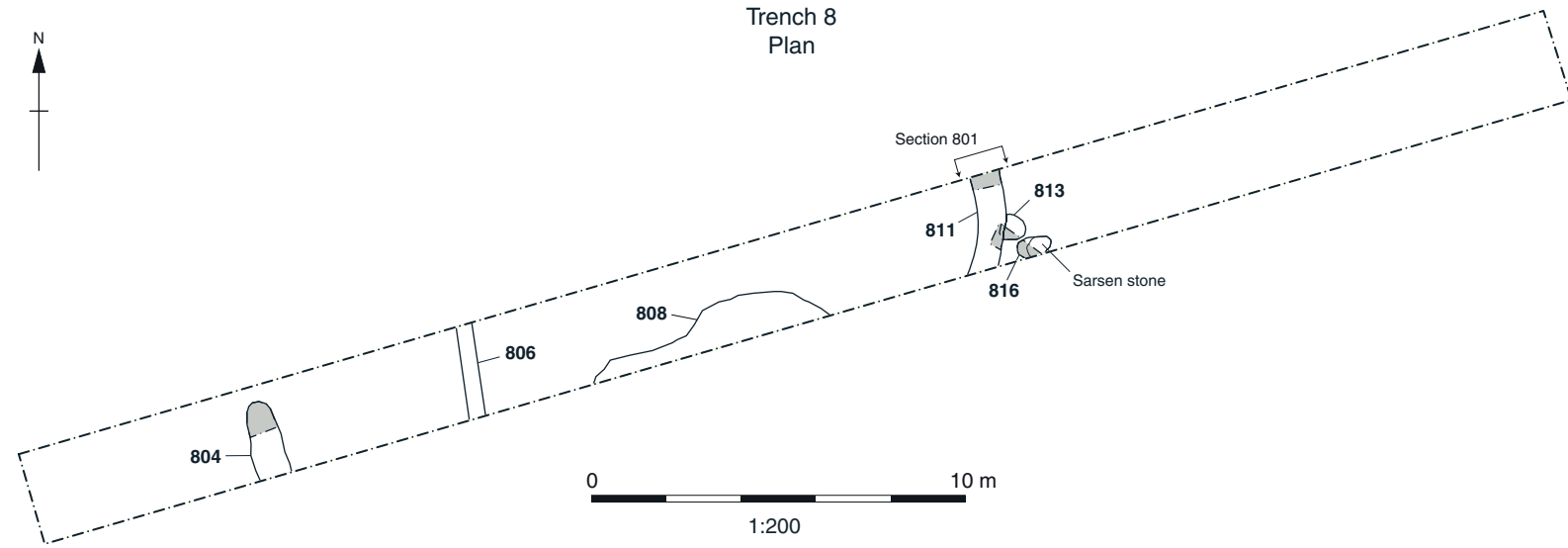

Figure 20: Trench 8; plan and selected section



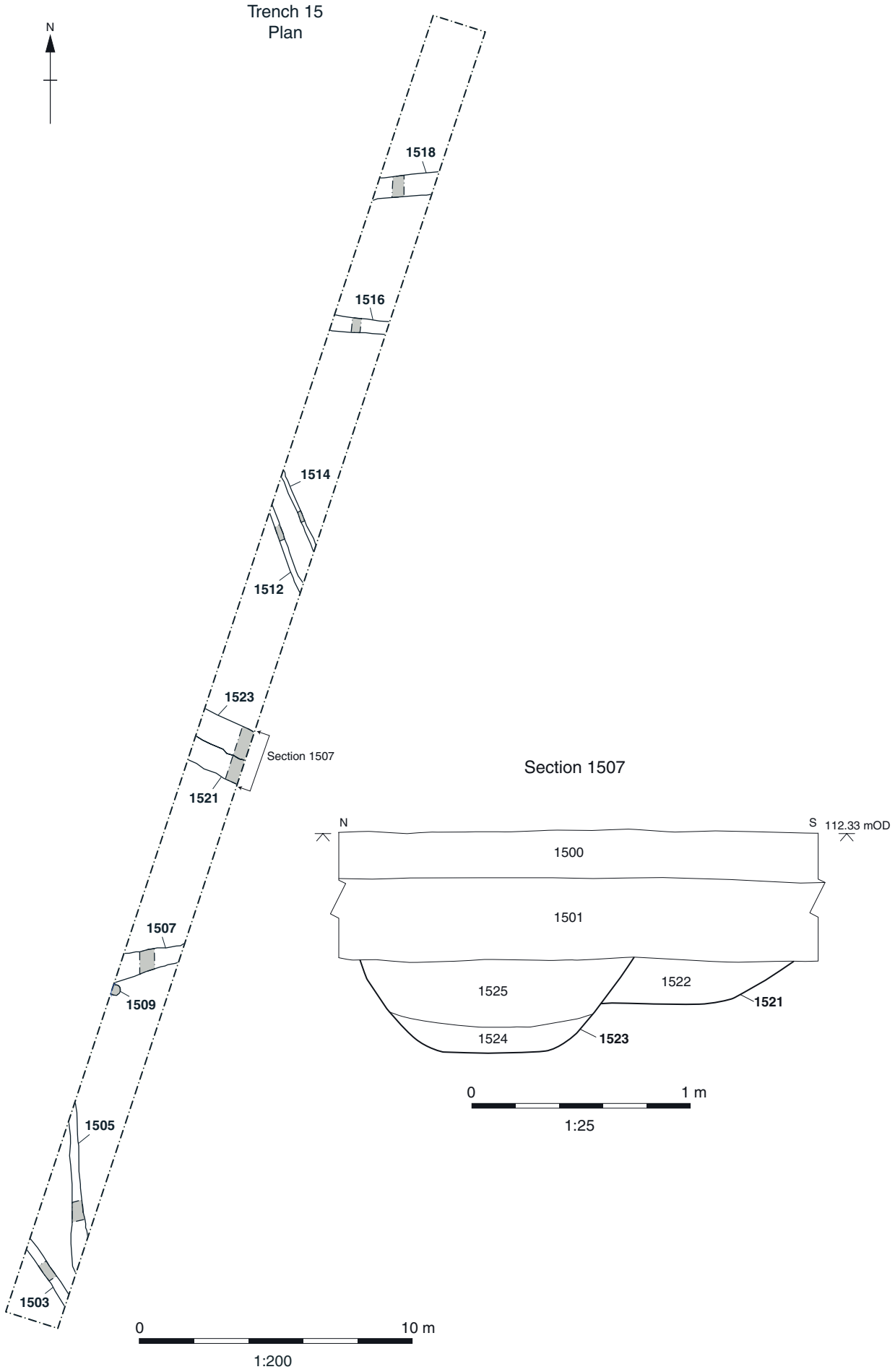

Figure 21: Trench 15; plan and selected section

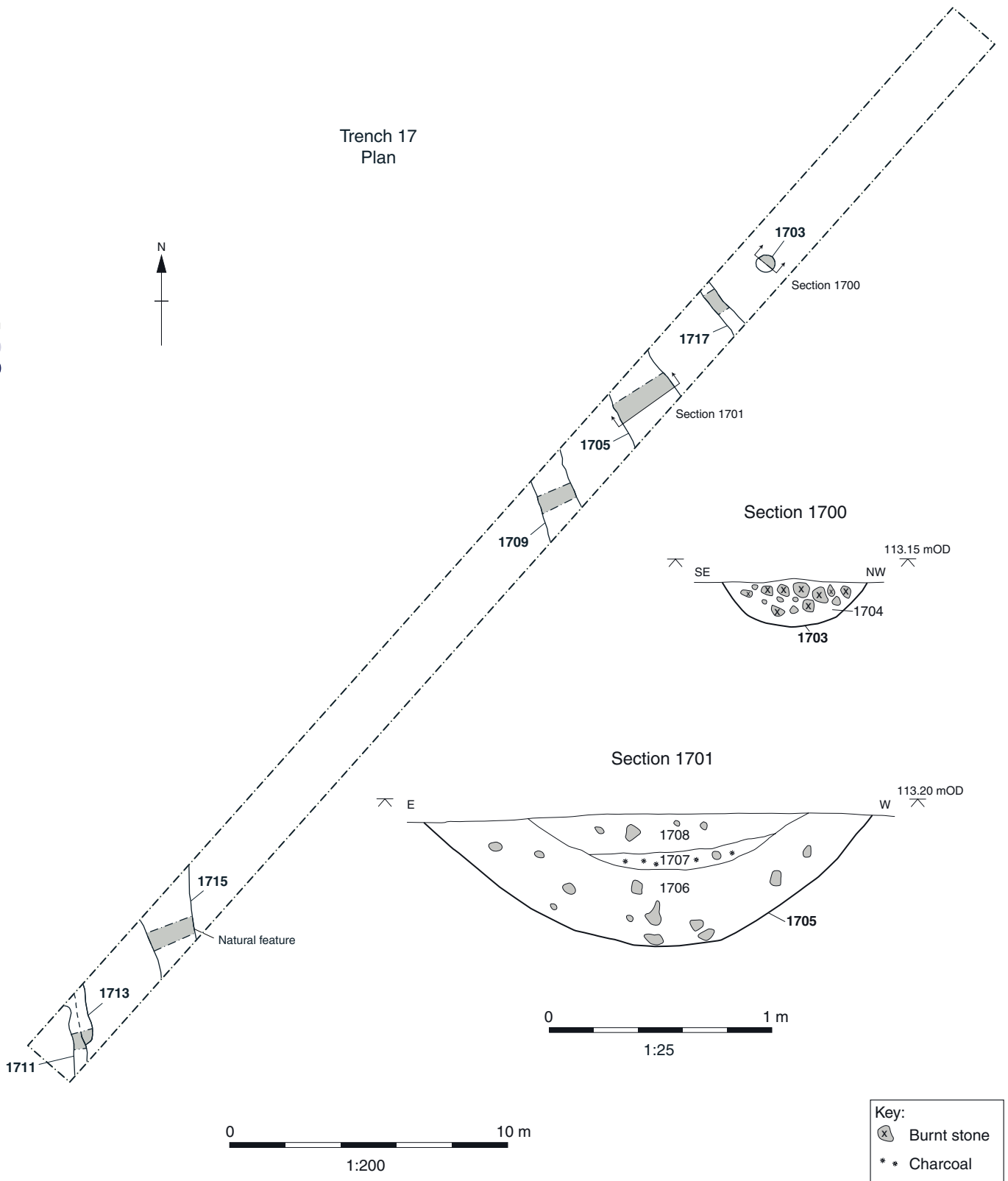

Figure 22: Trench 17; plan and selected sections

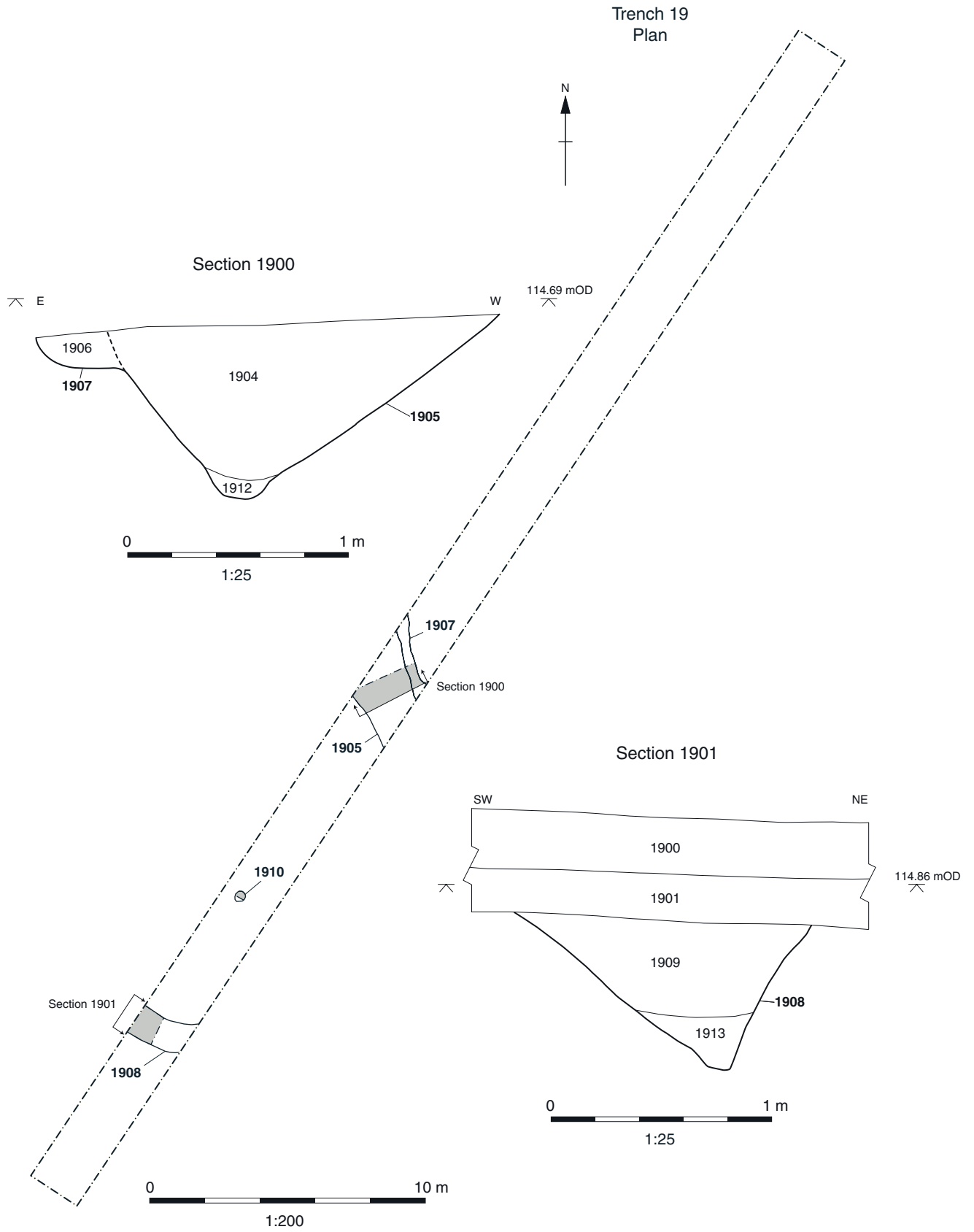

Figure 23: Trench 19; plan and selected sections

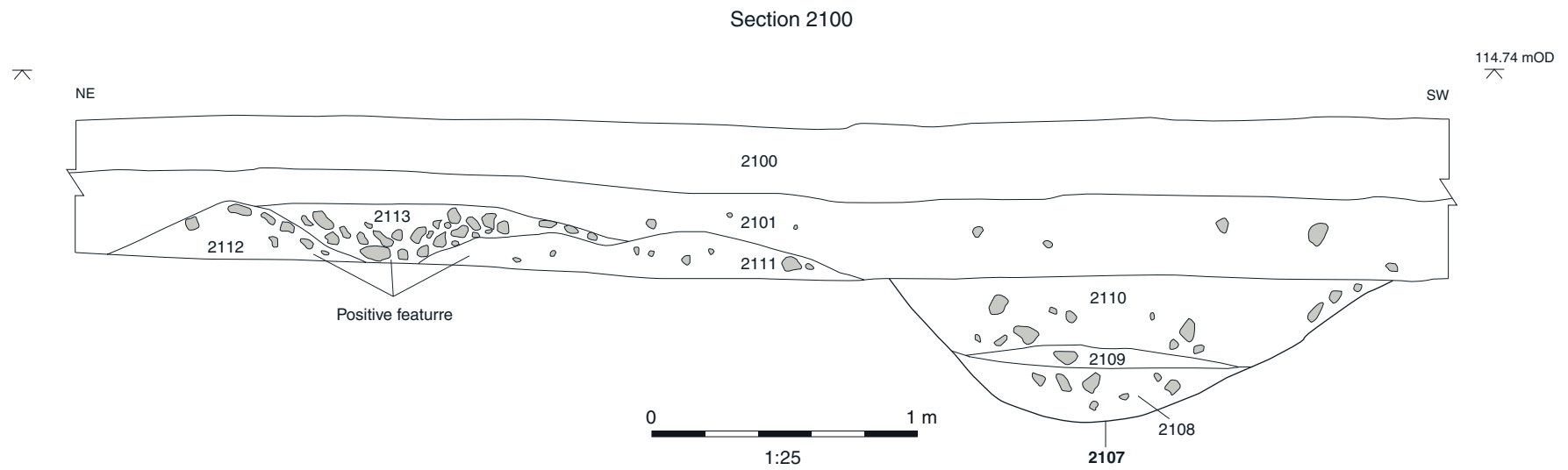
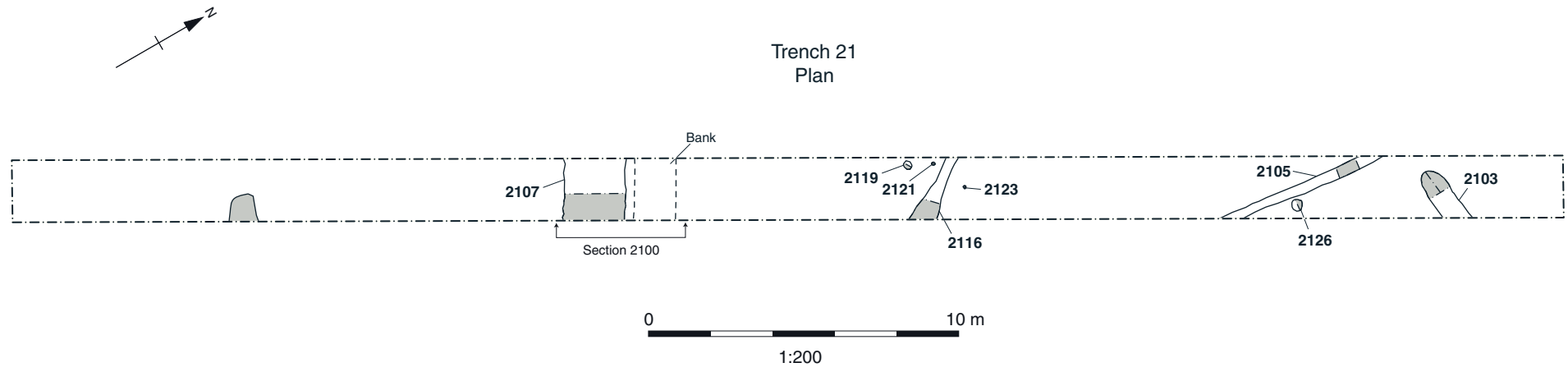

Figure 24: Trench 21; plan and selected section

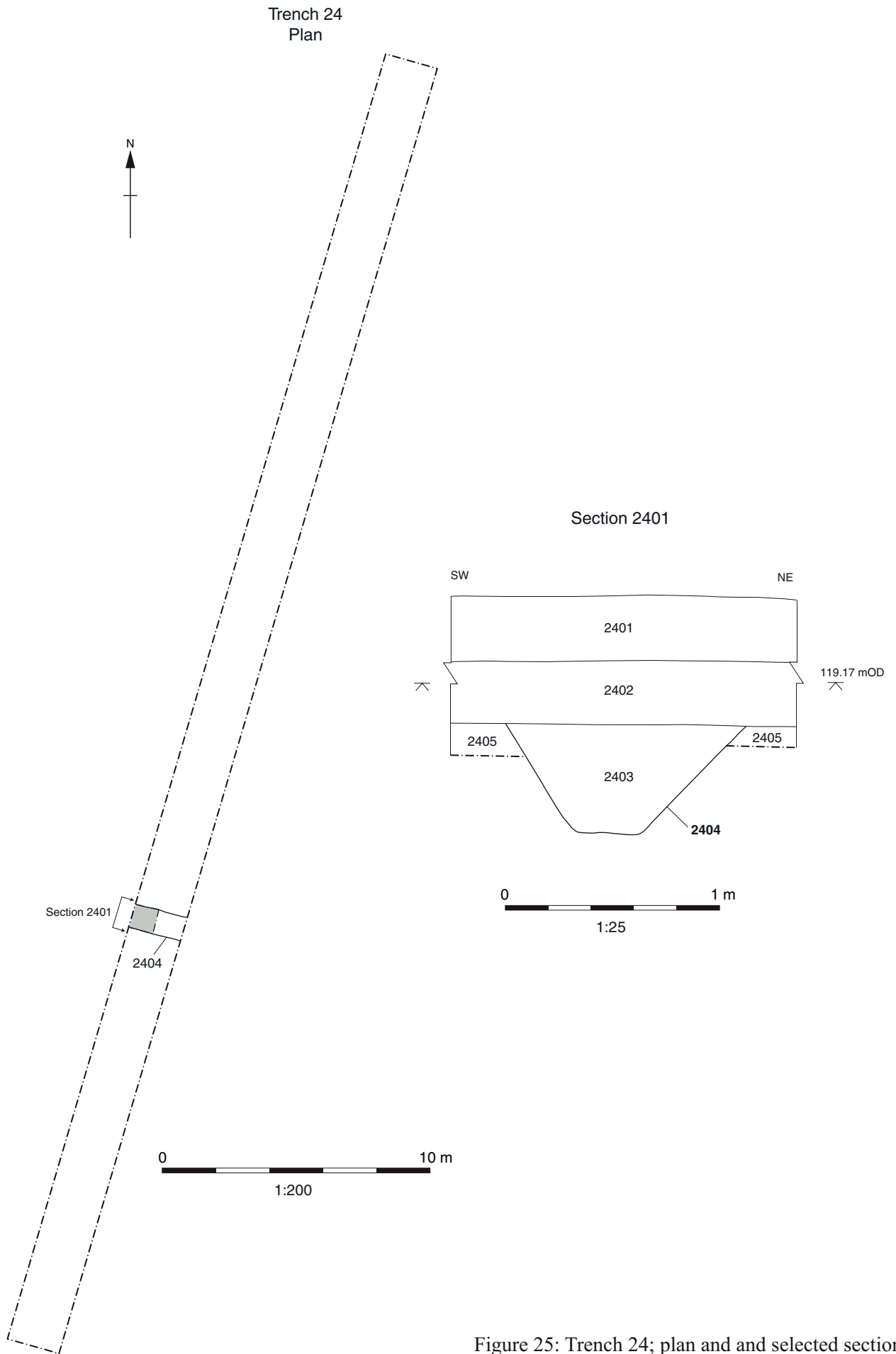

Figure 25: Trench 24; plan and and selected section

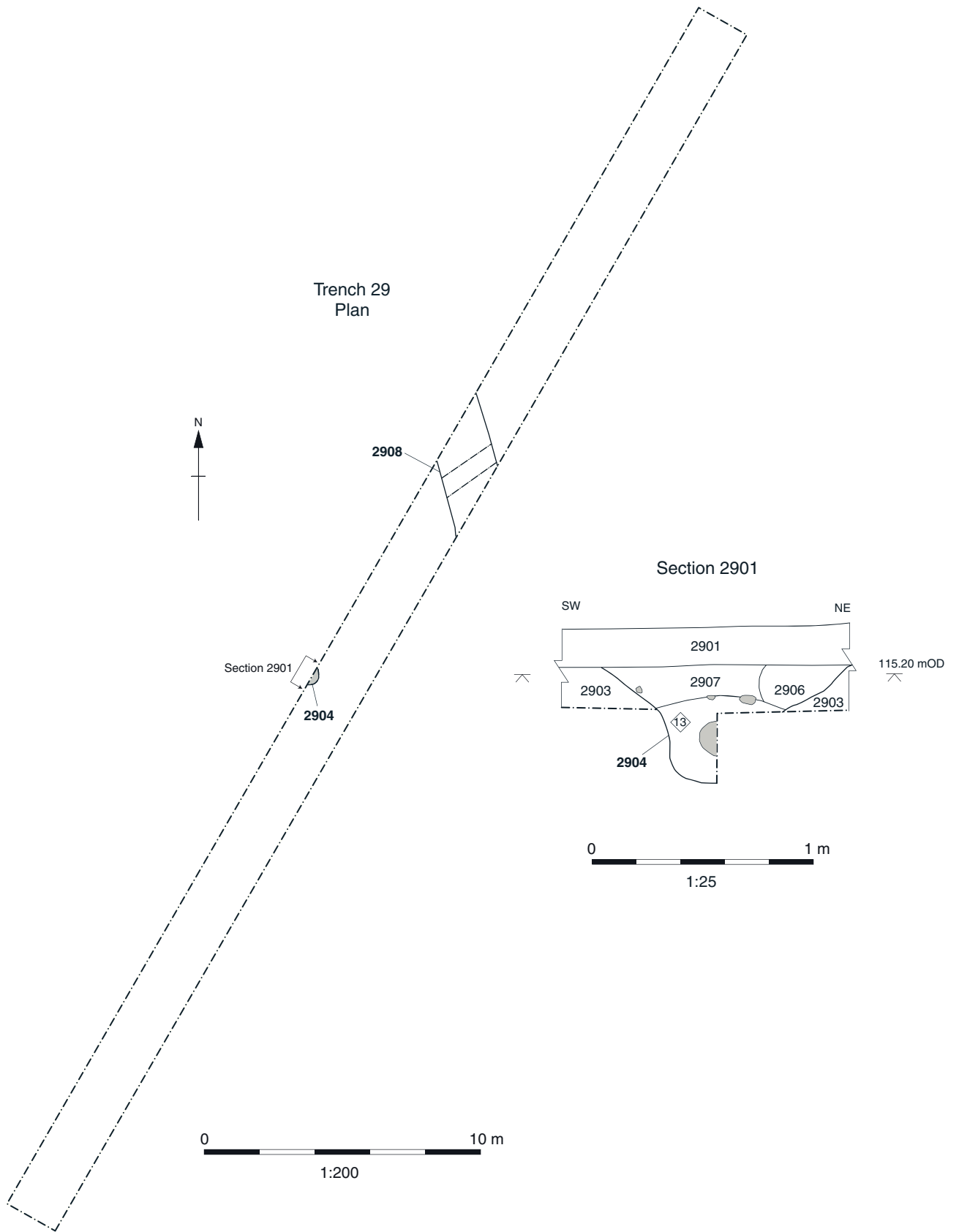

Figure 26: Trench 29; plan and and selected section

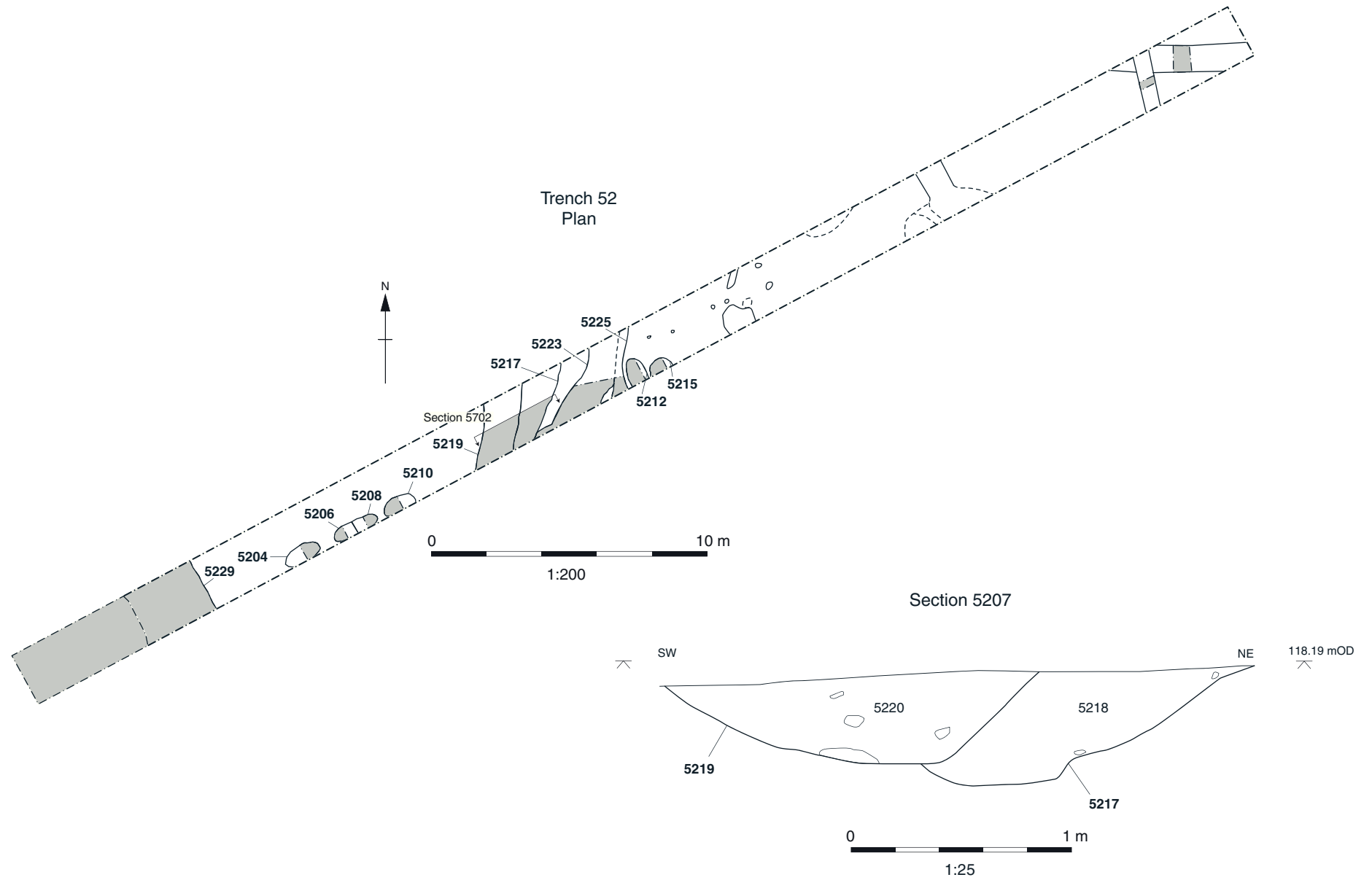

Figure 27: Trench 52; plan and and selected section

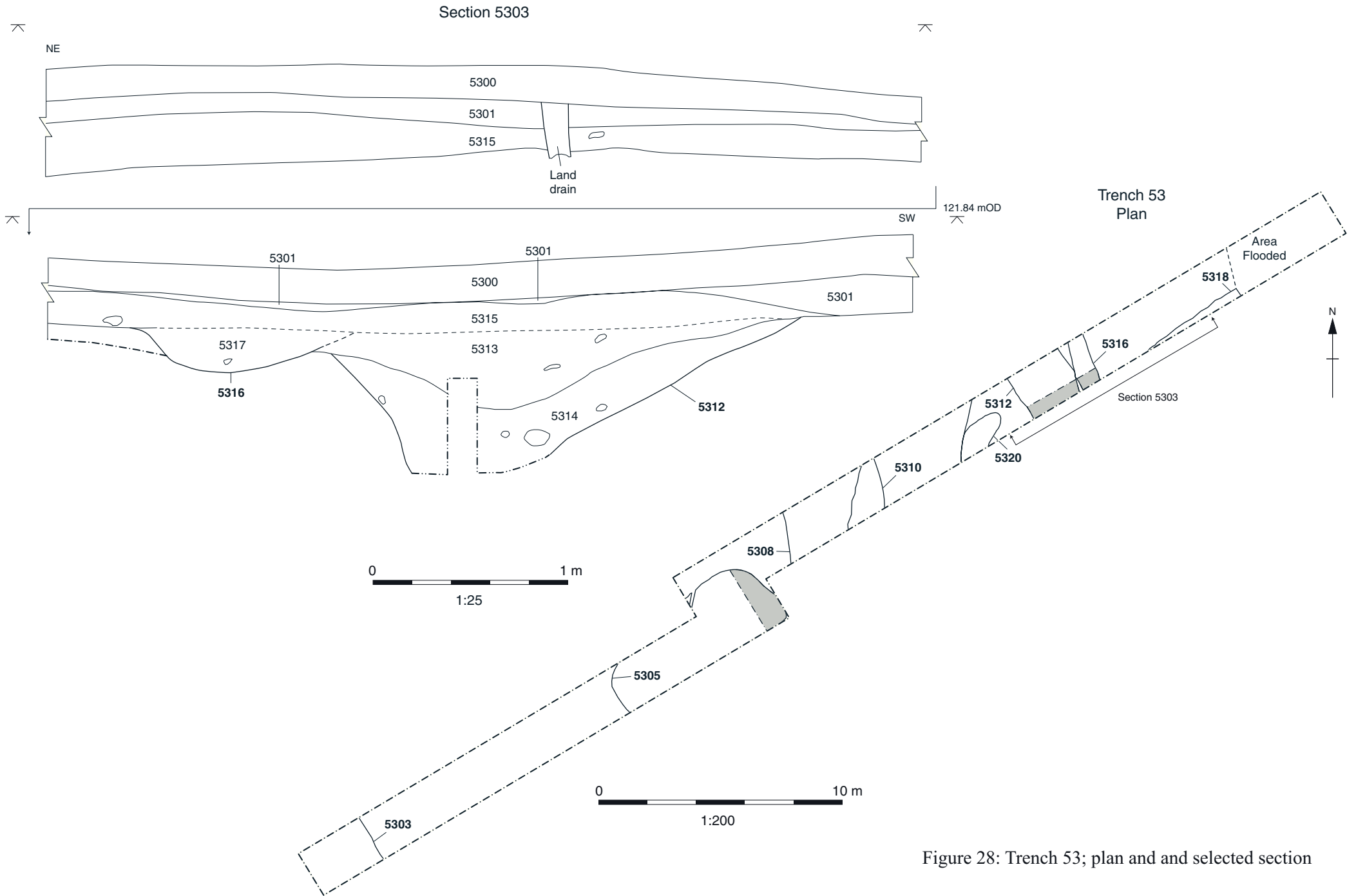

Figure 28: Trench 53; plan and selected section



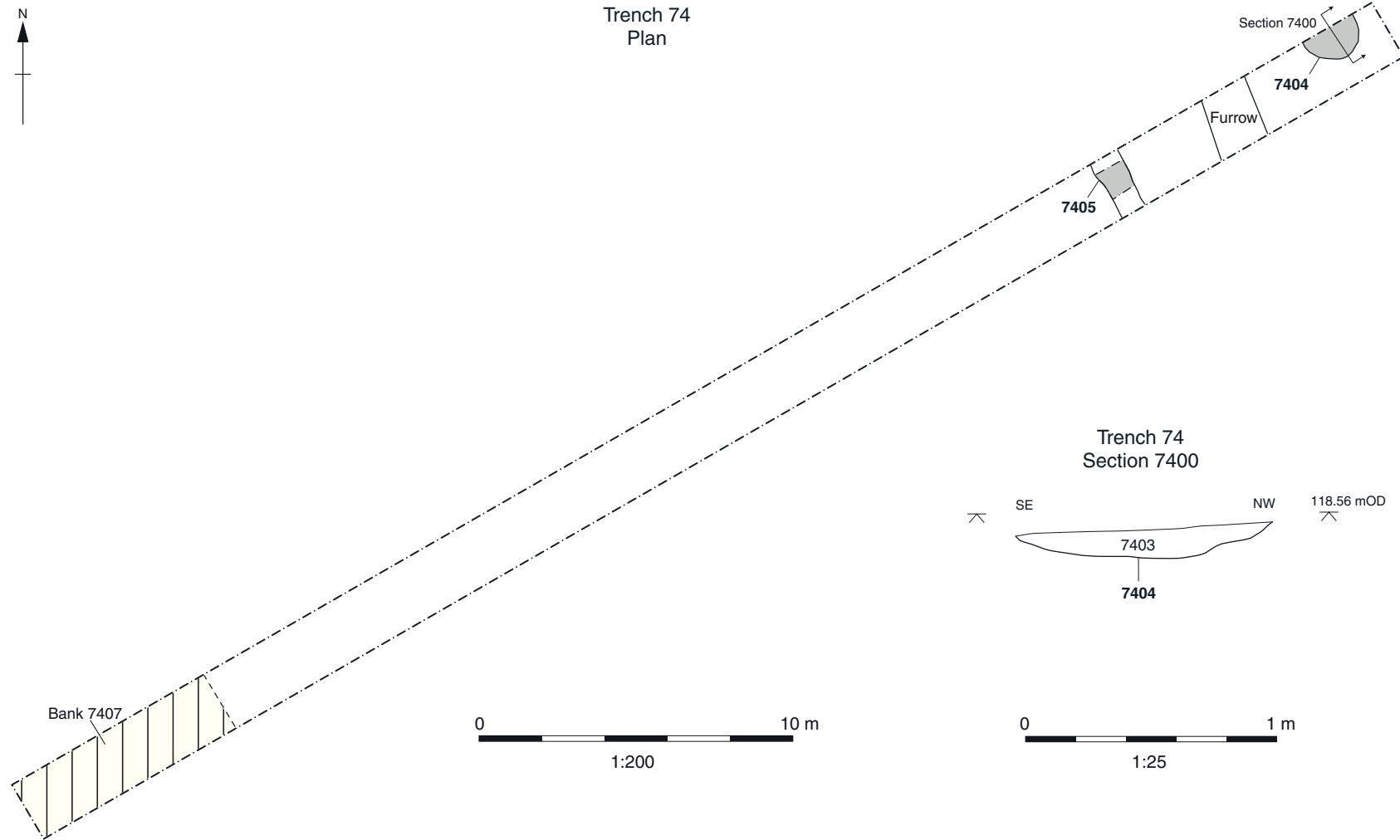

Figure 29: Trench 74; plan and and selected section

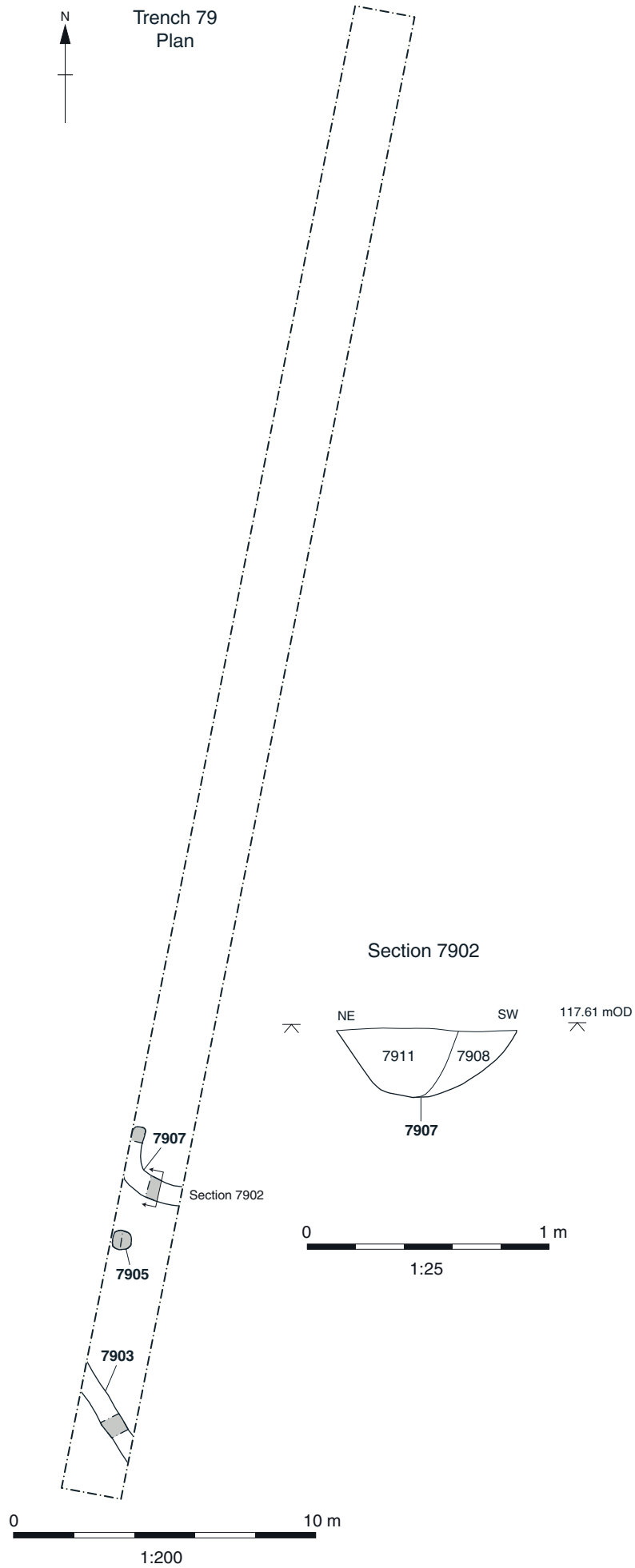

Figure 30: Trench 79; plan and selected section

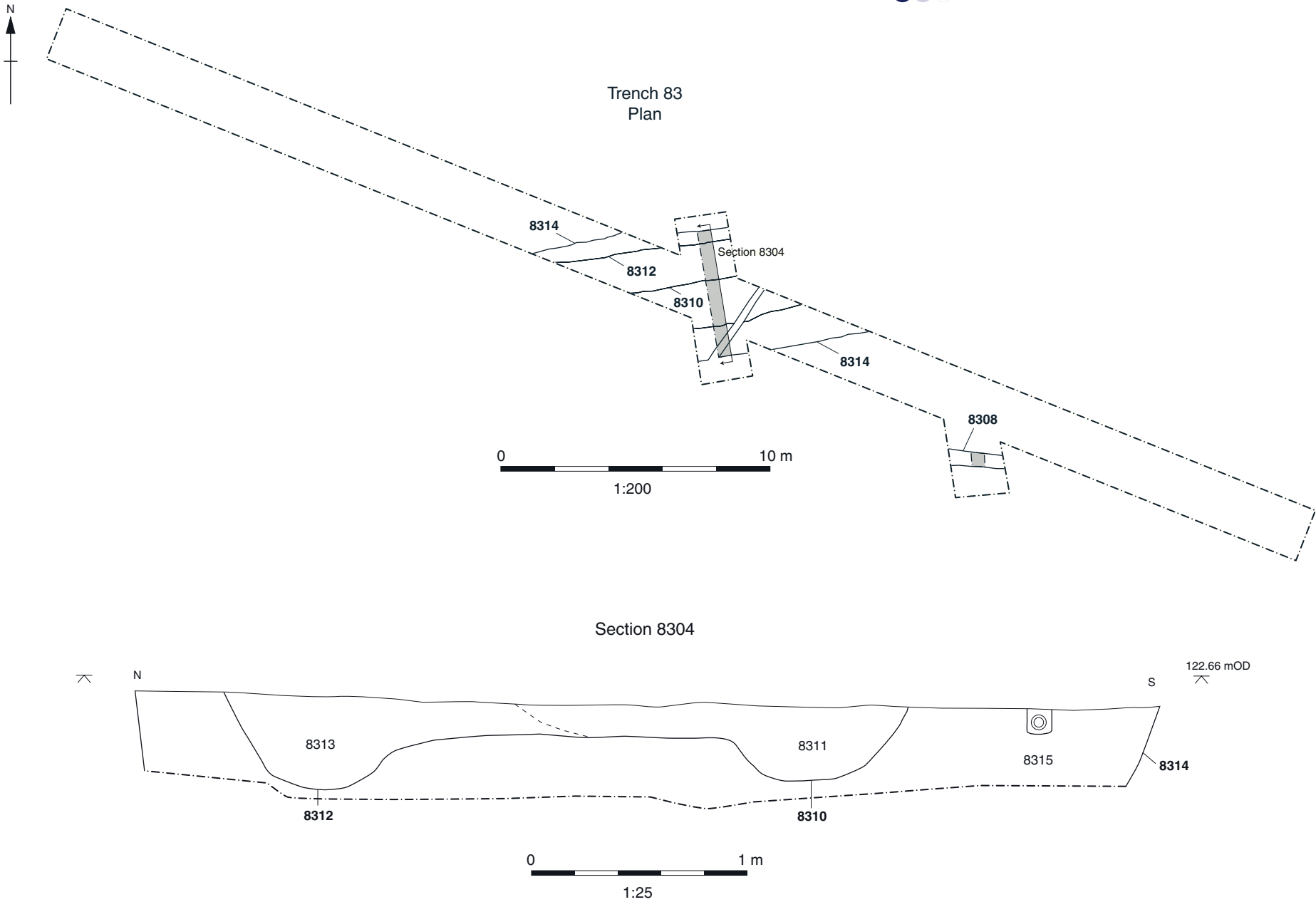

Figure 31: Trench 83; plan and selected section

### Trench 84 Plan

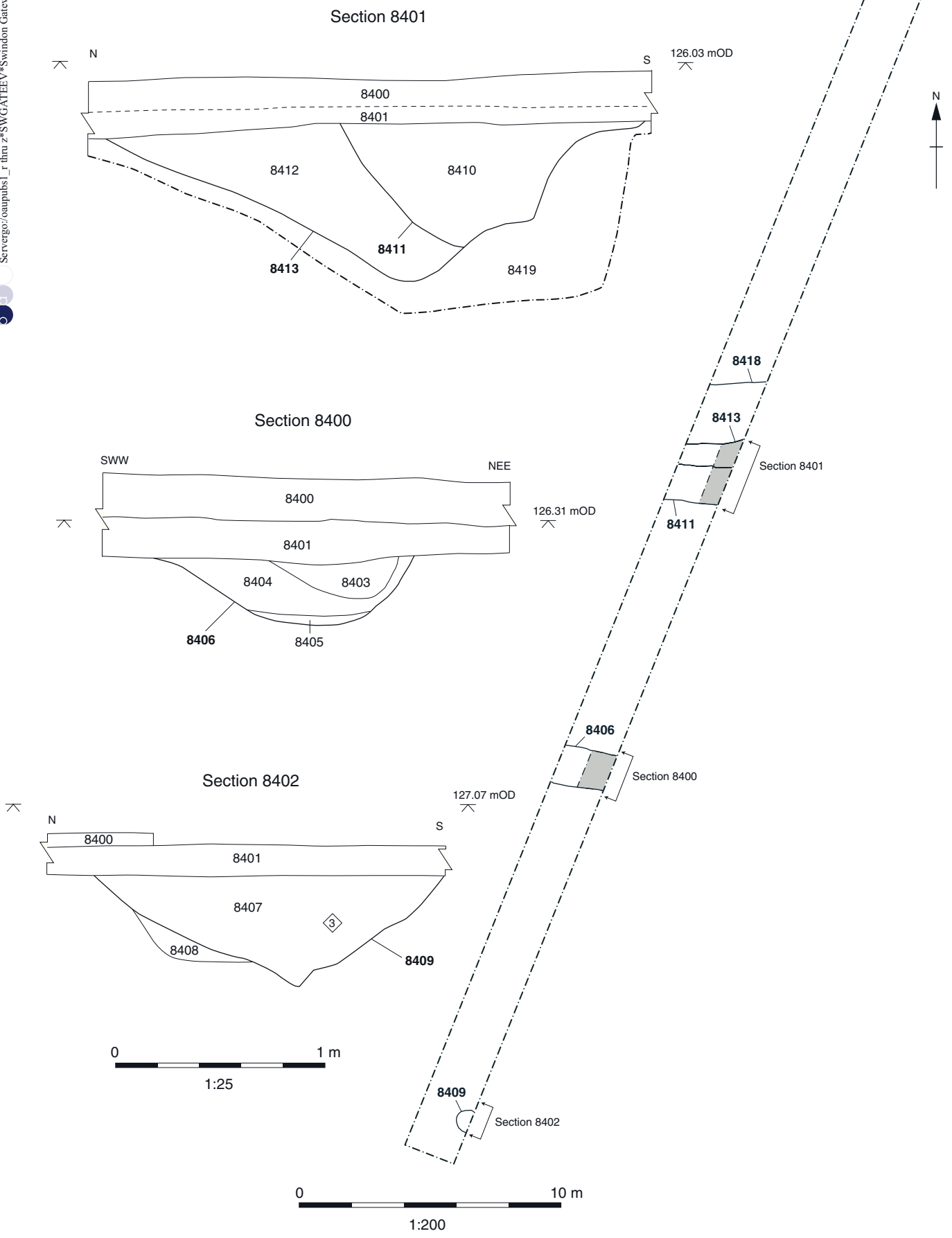

Figure 32: Trench 84; plan and selected sections

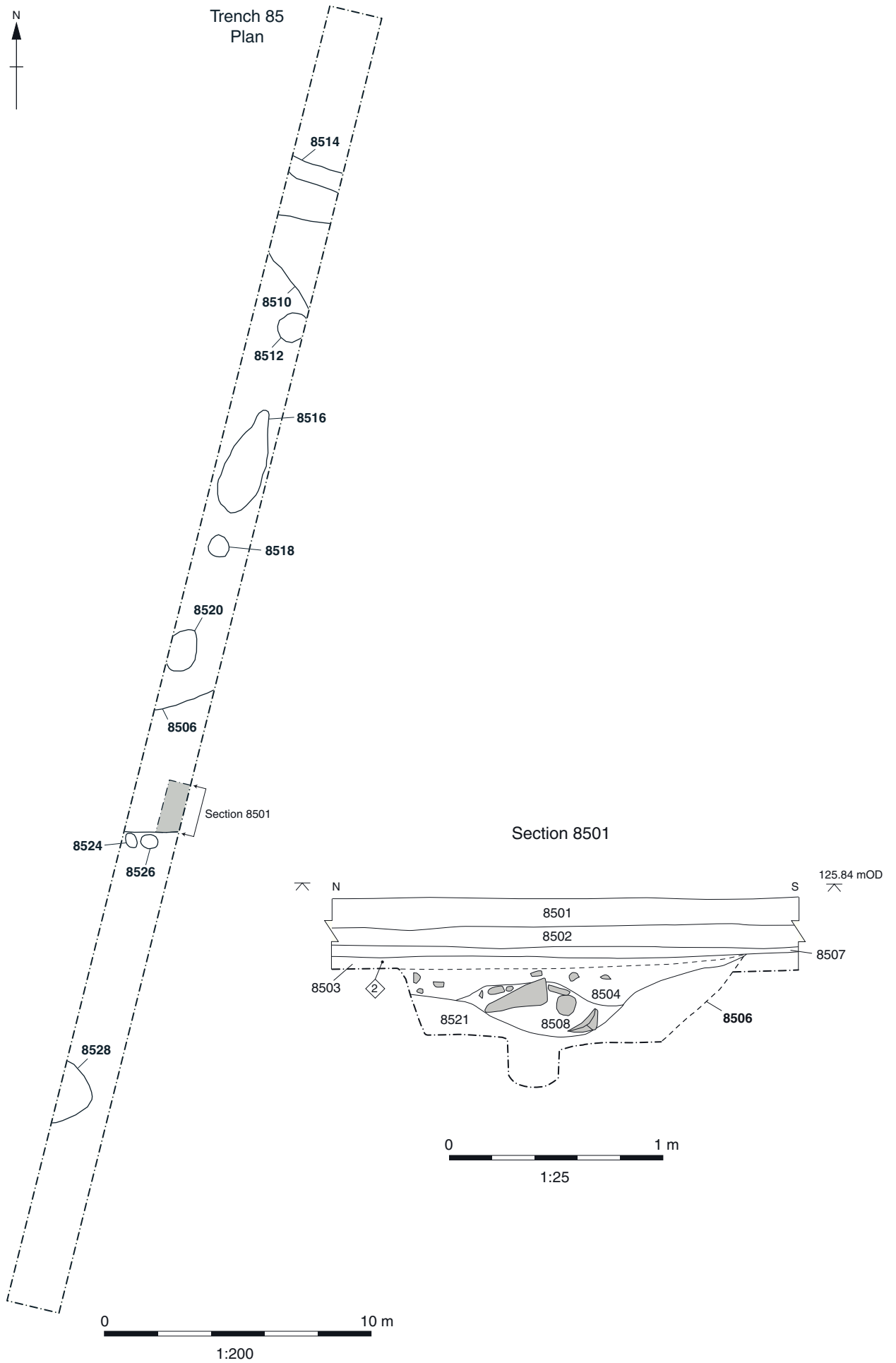

Figure 33: Trench 85; plan and and selected section

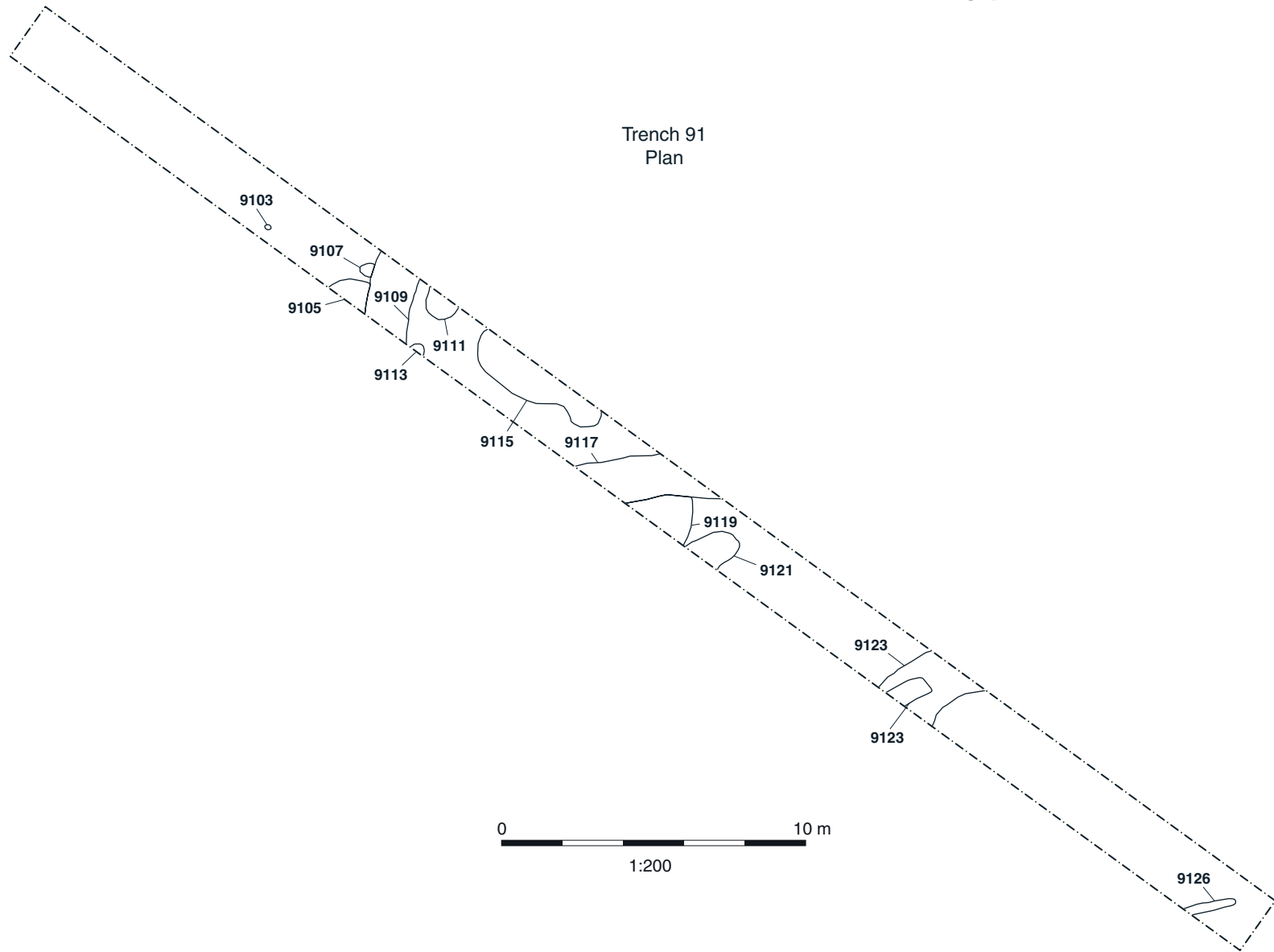

Figure 34: Trench 91; plan

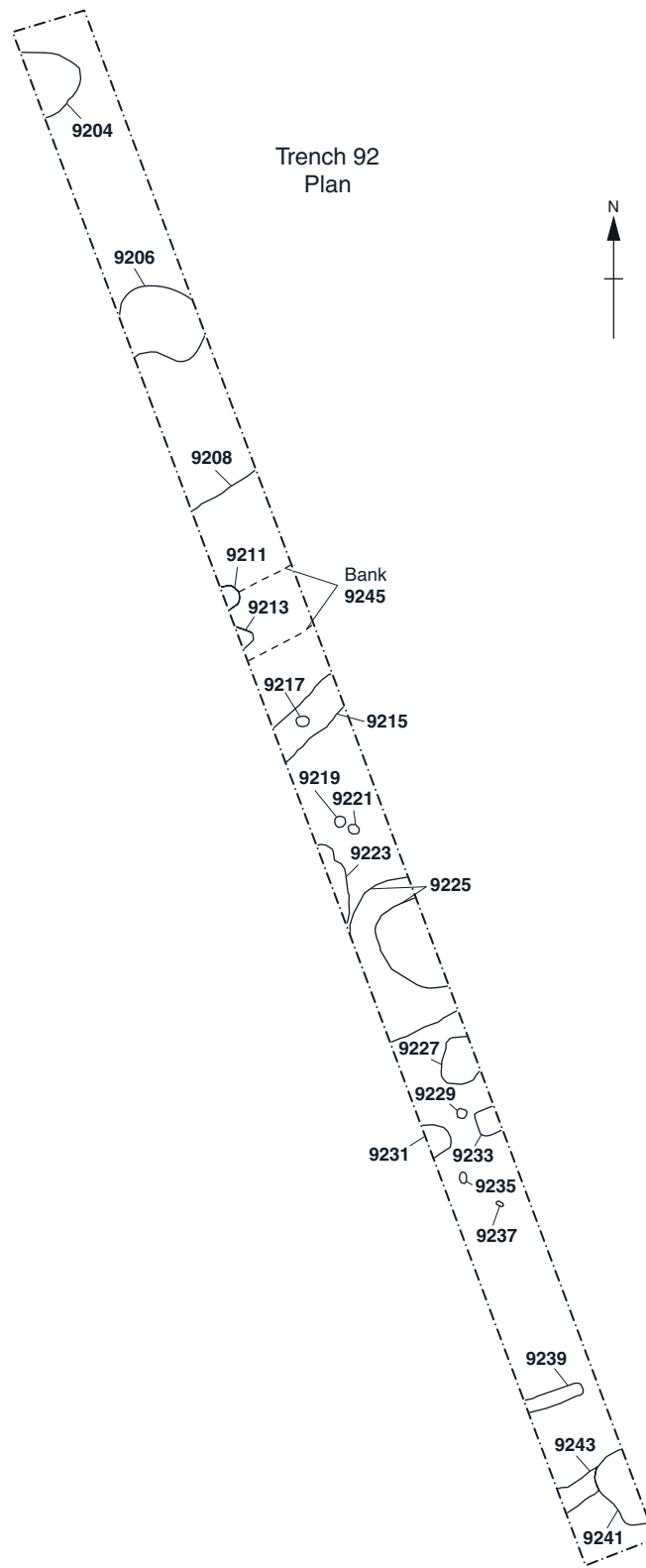

Figure 35: Trench 92; plan

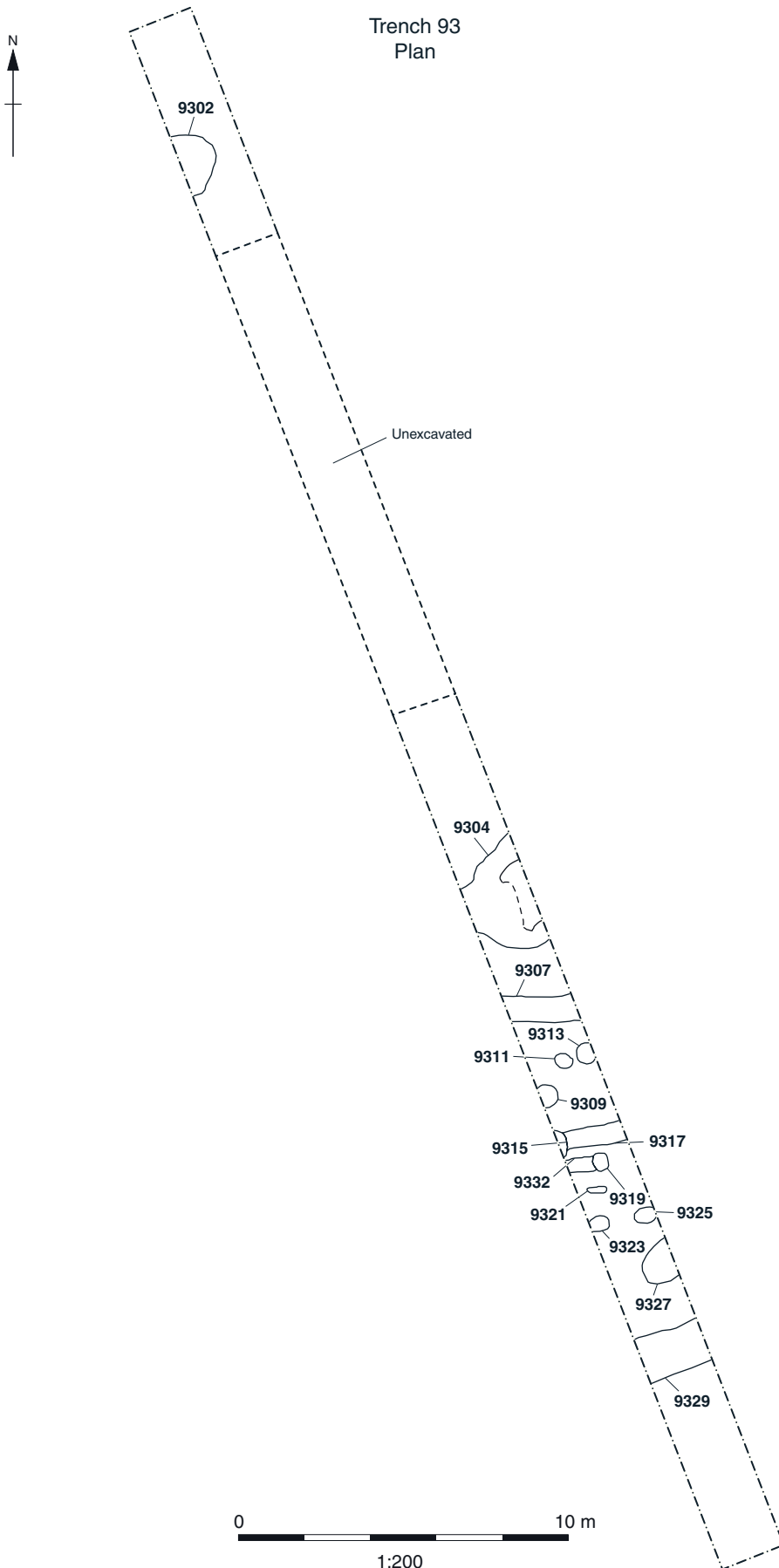
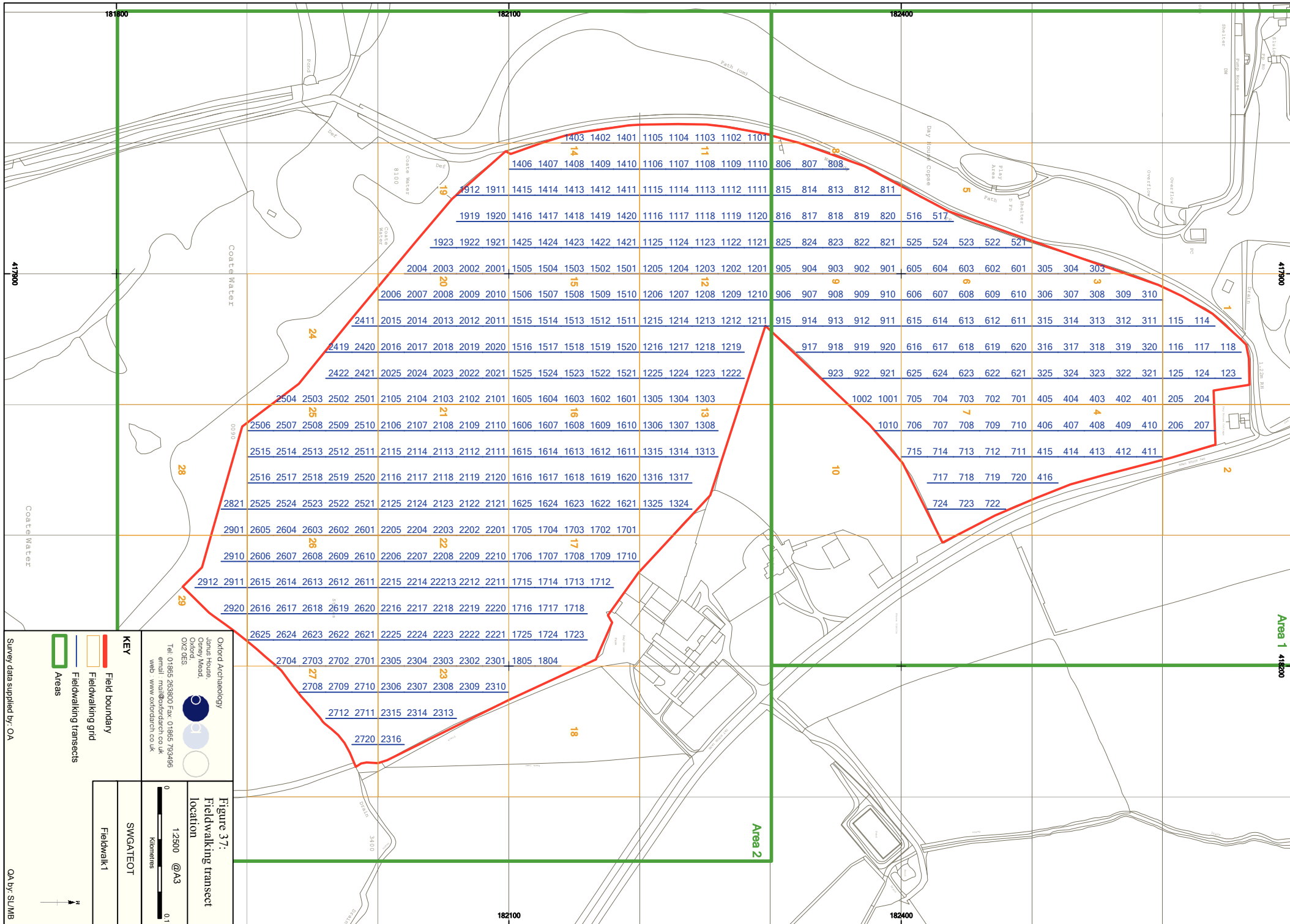

Figure 36: Trench 93; plan





Area 1 417800

Area 2

Oxford Archaeology/  
 Juniper House,  
 Oxford,  
 OX2 0ES  
 Tel: 01865 263800 Fax: 01865 793496  
 email: info@oxford.ac.uk  
 web: www.oxford.ac.uk

Figure 37:  
 Fieldwalking transect  
 location  
 1:2500 @A3  
 Kilometres

**KEY**

- Field boundary
- Fieldwalking grid
- Fieldwalking transects
- Areas

Survey data supplied by: OA

SWGATEOT

Fieldwalk 1

OA by SLMB

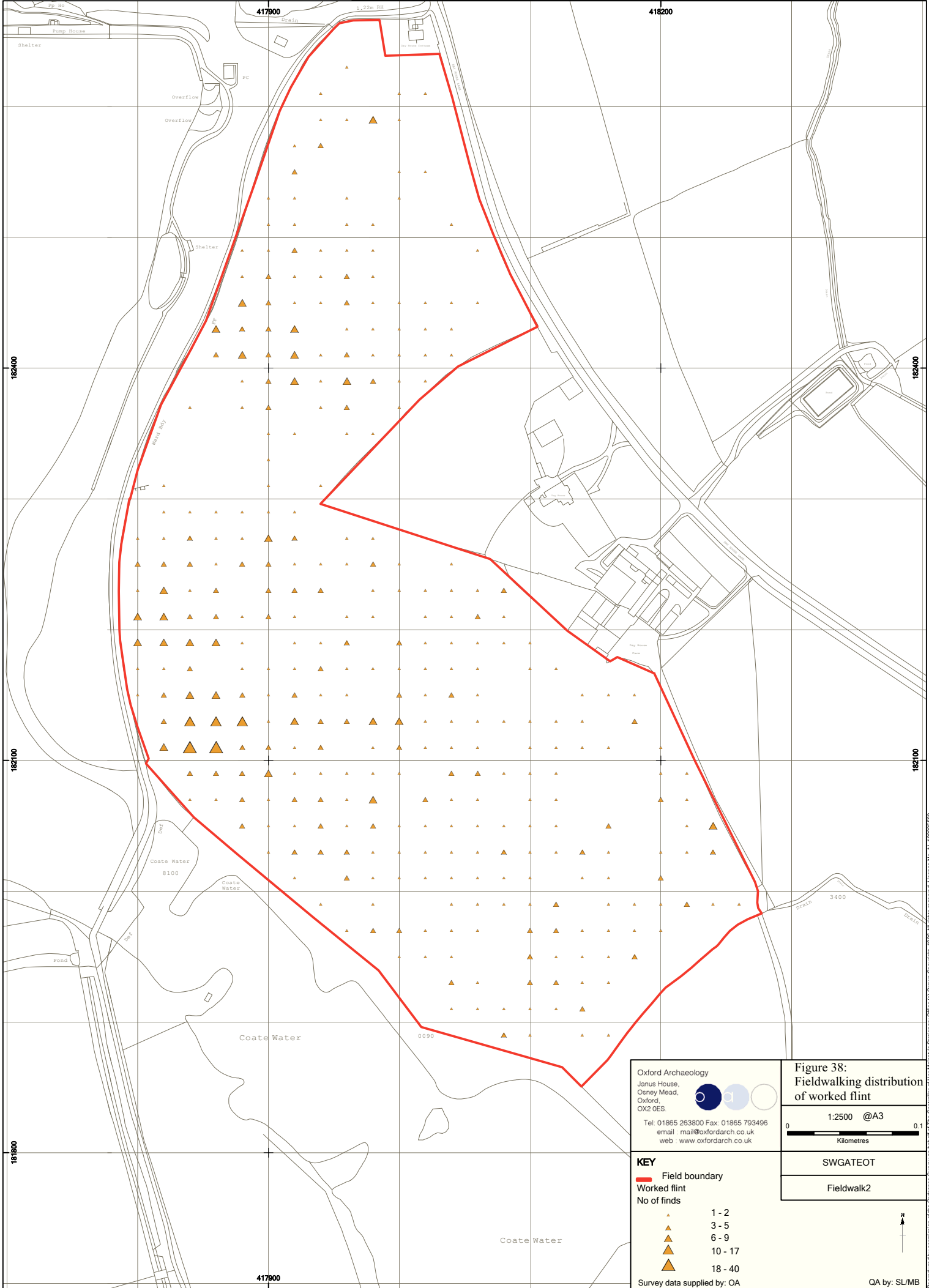

Oxford Archaeology  
 Janus House,  
 Osney Mead,  
 Oxford,  
 OX2 0ES.  
 Tel: 01865 263800 Fax: 01865 793496  
 email: mail@oxfordarch.co.uk  
 web: www.oxfordarch.co.uk

**Figure 38:**  
 Fieldwalking distribution  
 of worked flint

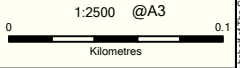

**KEY**

Field boundary

Worked flint

No of finds

▲	1 - 2
▲▲	3 - 5
▲▲▲	6 - 9
▲▲▲▲	10 - 17
▲▲▲▲▲	18 - 40

Survey data supplied by: OA

SWGATEOT

Fieldwalk2

QA by: SL/MB



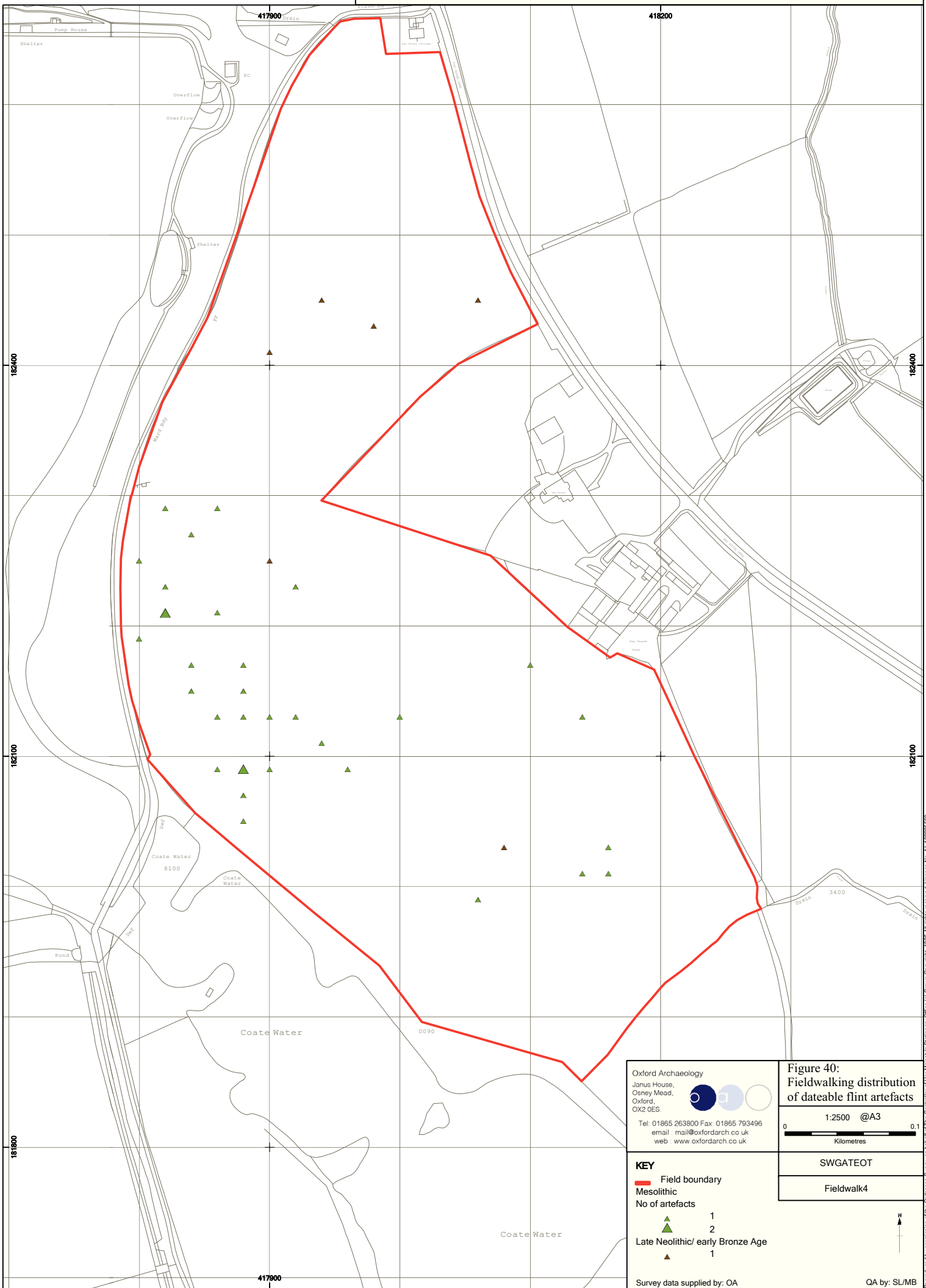

Oxford Archaeology  
 Janus House,  
 Osney Mead,  
 Oxford,  
 OX2 0ES.  
 Tel: 01865 263800 Fax: 01865 793496  
 email: mail@oxfordarch.co.uk  
 web: www.oxfordarch.co.uk

**Figure 40:**  
 Fieldwalking distribution  
 of dateable flint artefacts

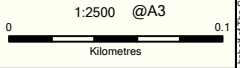

**KEY**

Field boundary  
 Mesolithic  
 No of artefacts  
 Late Neolithic/ early Bronze Age

▲	1
▲	2
▲	1

Survey data supplied by: OA

SWGATEOT

Fieldwalk4

QA by: SL/MB

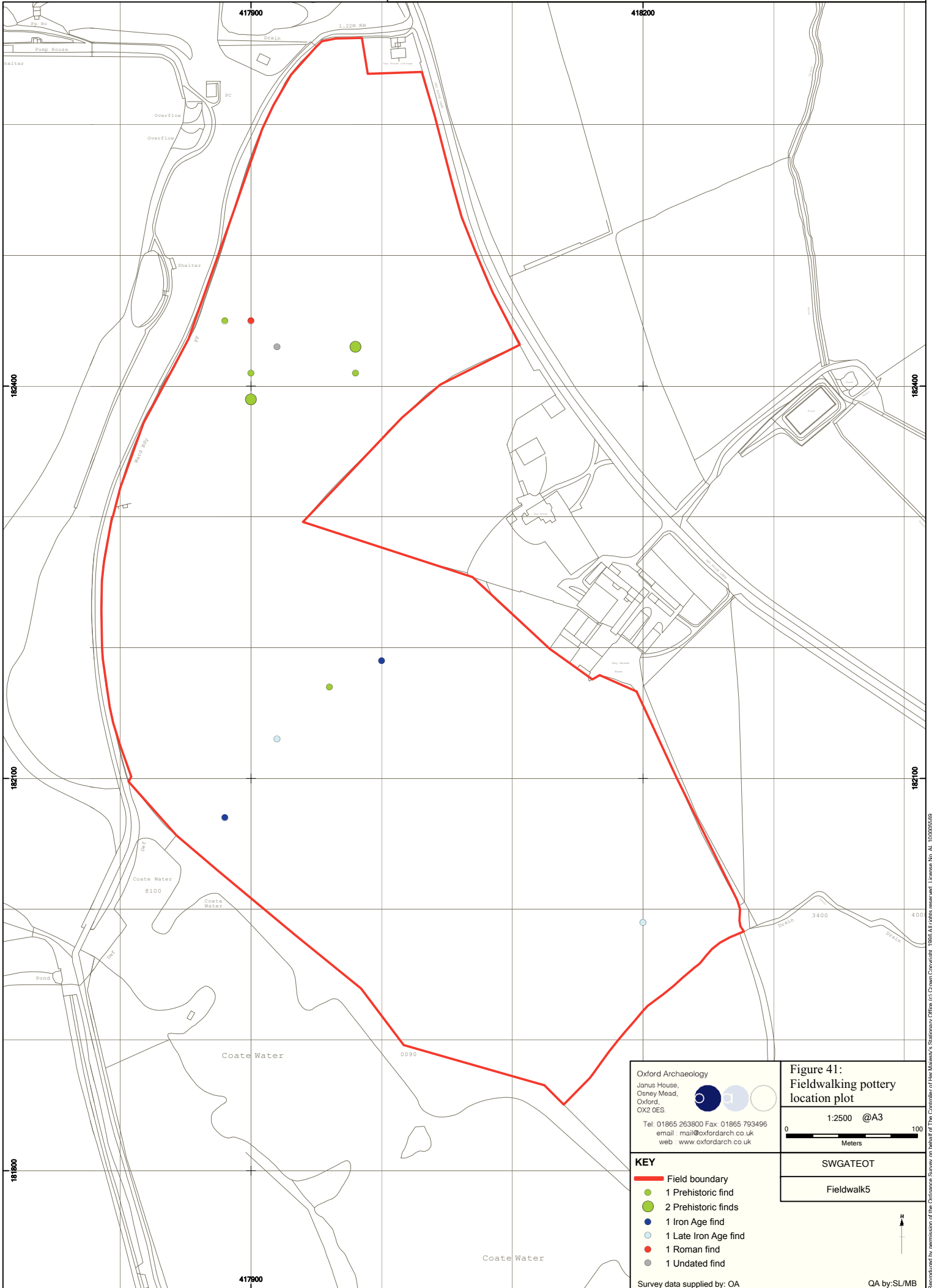

Oxford Archaeology  
 Janus House,  
 Osney Mead,  
 Oxford,  
 OX2 0ES.  
 Tel: 01865 263800 Fax: 01865 793496  
 email: mail@oxfordarch.co.uk  
 web: www.oxfordarch.co.uk

**Figure 41:**  
**Fieldwalking pottery**  
**location plot**













1:2500 @A3  
 0 100  
 Meters

- KEY**
- Field boundary
  - 1 Prehistoric find
  - 2 Prehistoric finds
  - 1 Iron Age find
  - 1 Late Iron Age find
  - 1 Roman find
  - 1 Undated find

SWGATEOT  
 Fieldwalk5

Survey data supplied by: OA

QA by:SL/MB

	Section line and number
	Section through feature not illustrated with section drawing
	Limit of excavation
	Sondage / Interior limit of excavation
	Fill line and number
	Cut line and number
	Excavated feature
	Unclear boundary
	Stones
	Hachures indicate inclination of slope inside excavated feature
	Levels
	Grid point
	Continuation line (trench edge continues)