

COPYRIGHT

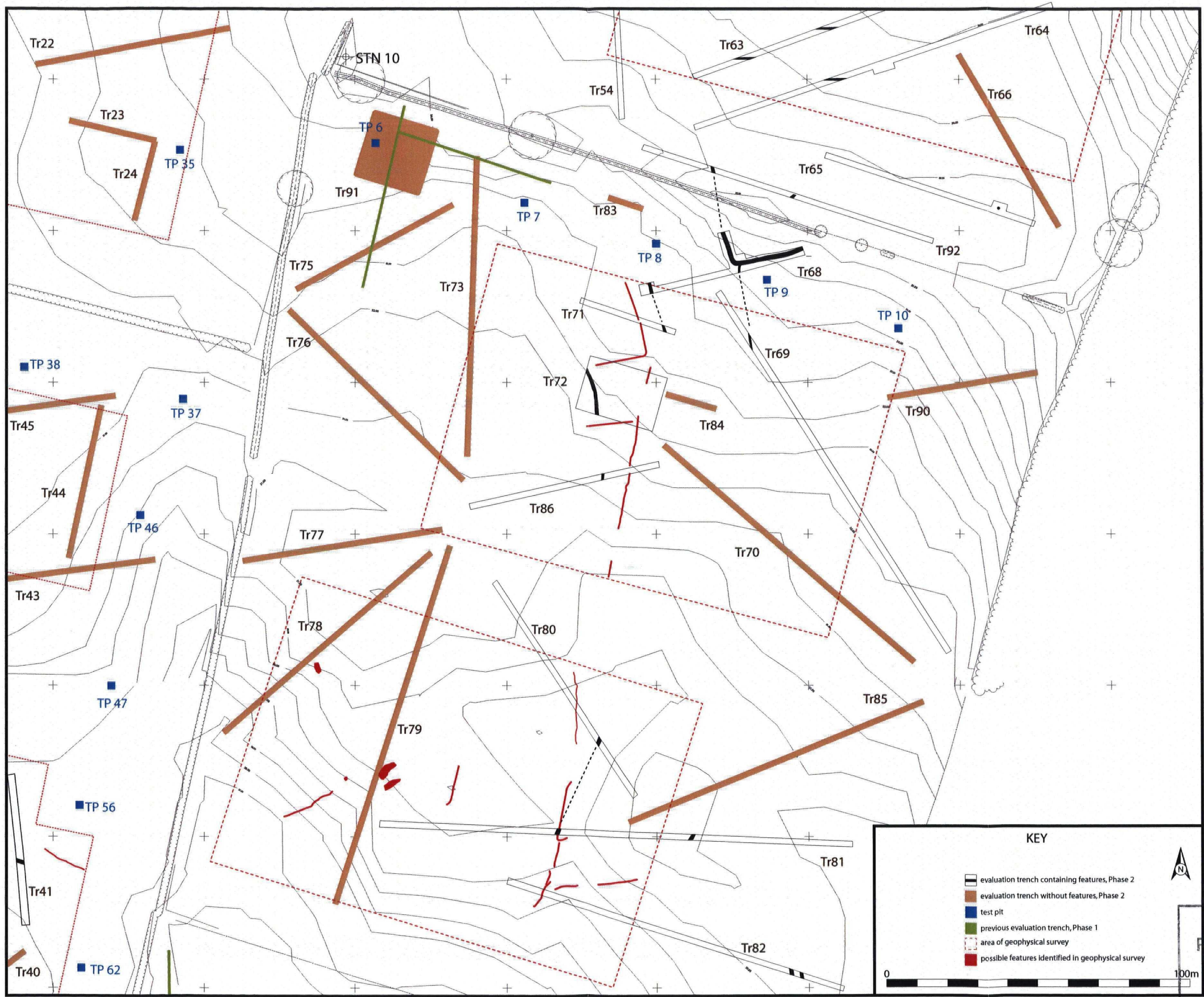
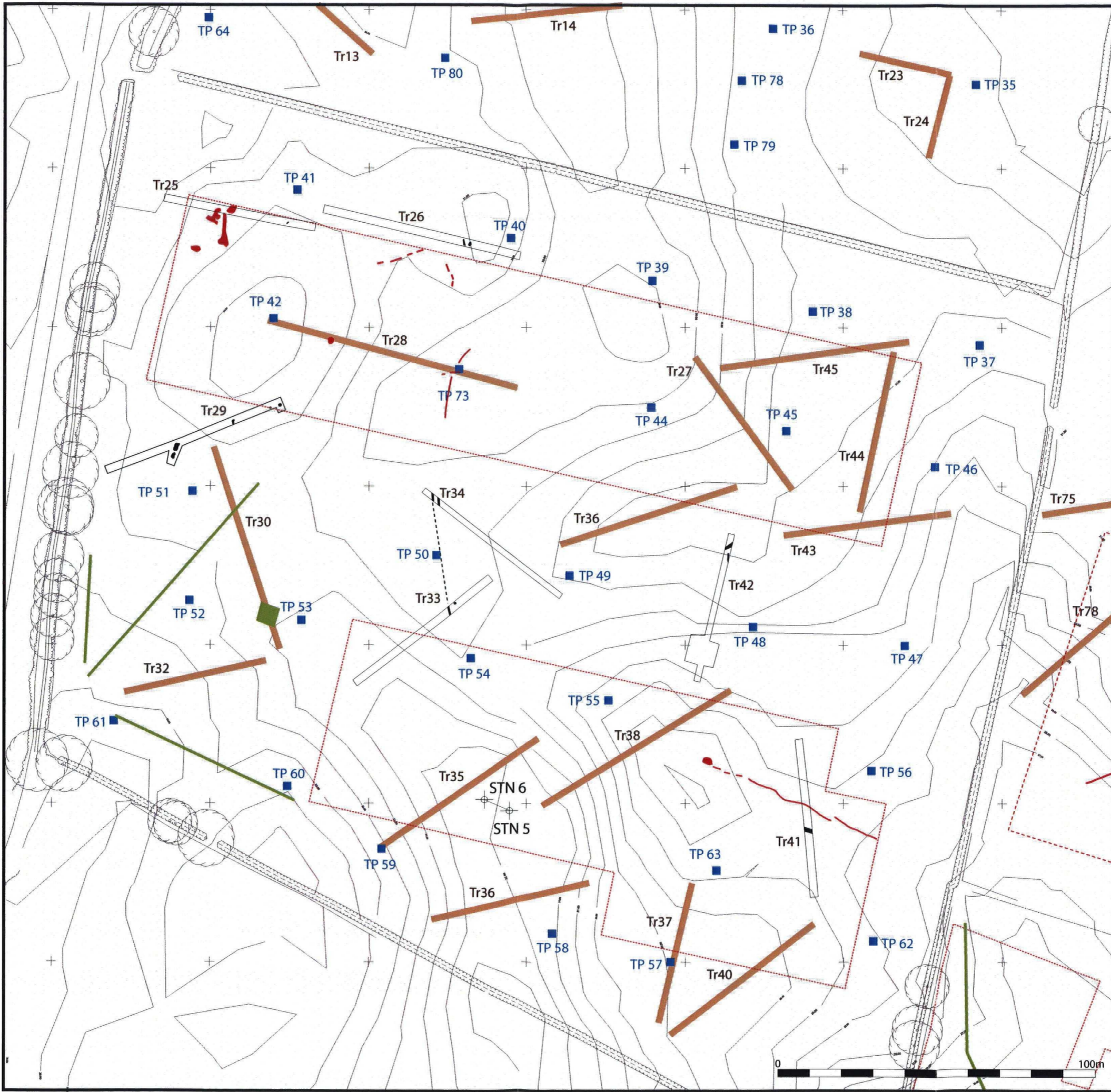

Figure 12: South east field showing trenches containing features

RECEIVED
PLANNING SERVICES
20 SEP 2006
TOWN HALL
SCARBOROUGH

COPYRIGHT

RECEIVED
PLANNING SERVICES
20 SEP 2006
TOP
SC 10000000.1



KEY

- evaluation trench containing features, Phase 2
- evaluation trench without features, Phase 2
- test pit
- previous evaluation trench, Phase 1
- area of geophysical survey
- possible features identified in geophysical survey

Figure 13: South west field showing trenches containing features



SCARBOROUGH
20 SEP 2006

COMPLIANT

Figure 14: North west field showing trenches containing features

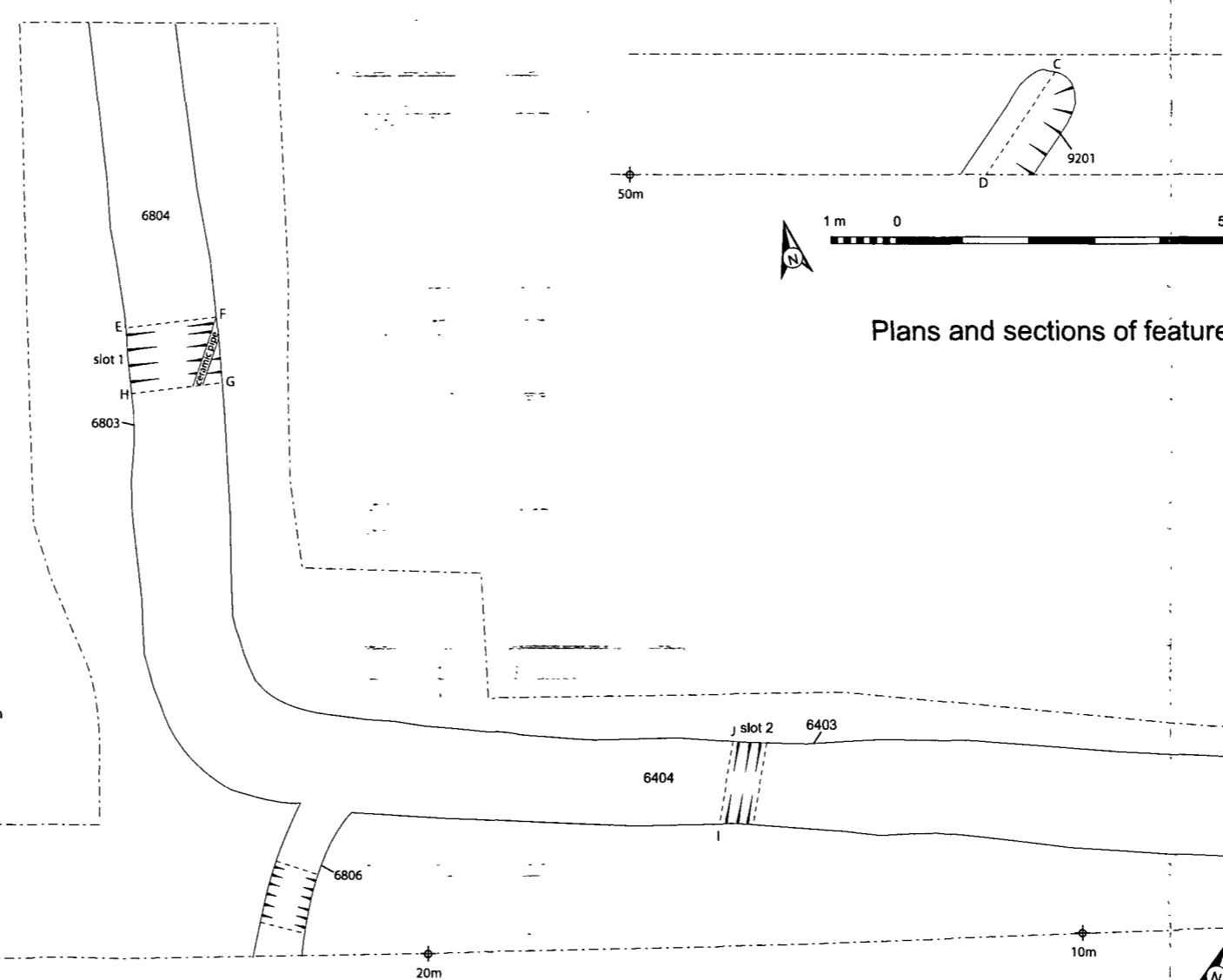
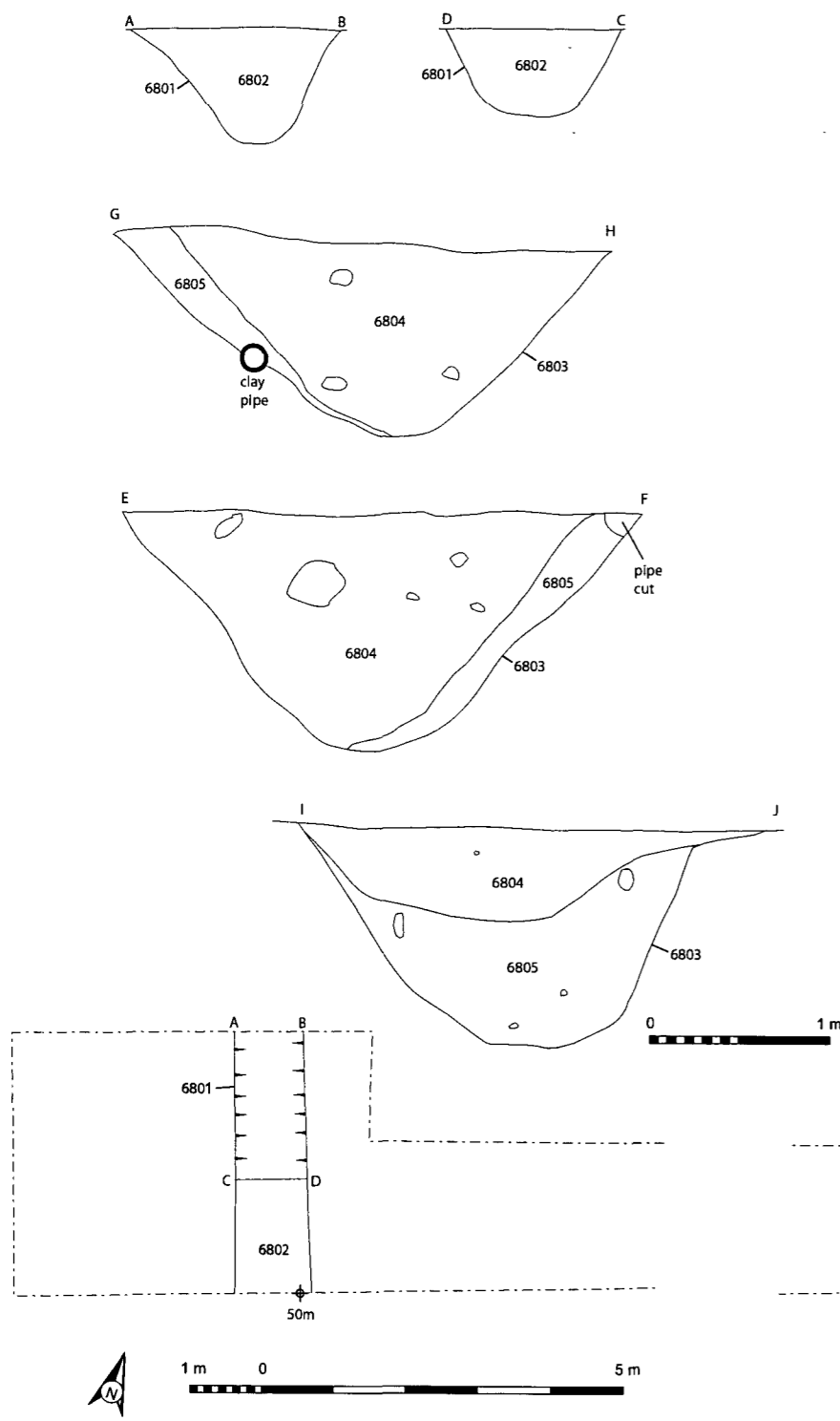

Plan and sections of features in of Trench 68

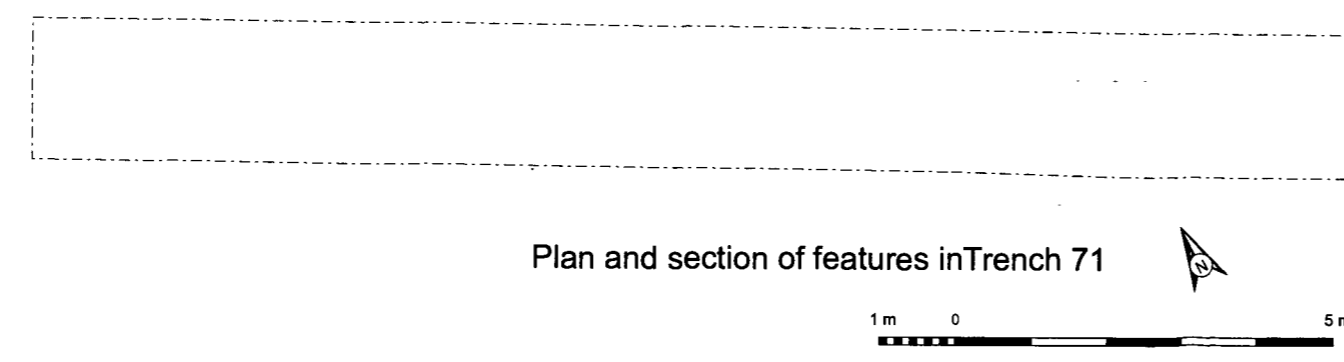

Plan and section of features in Trench 71

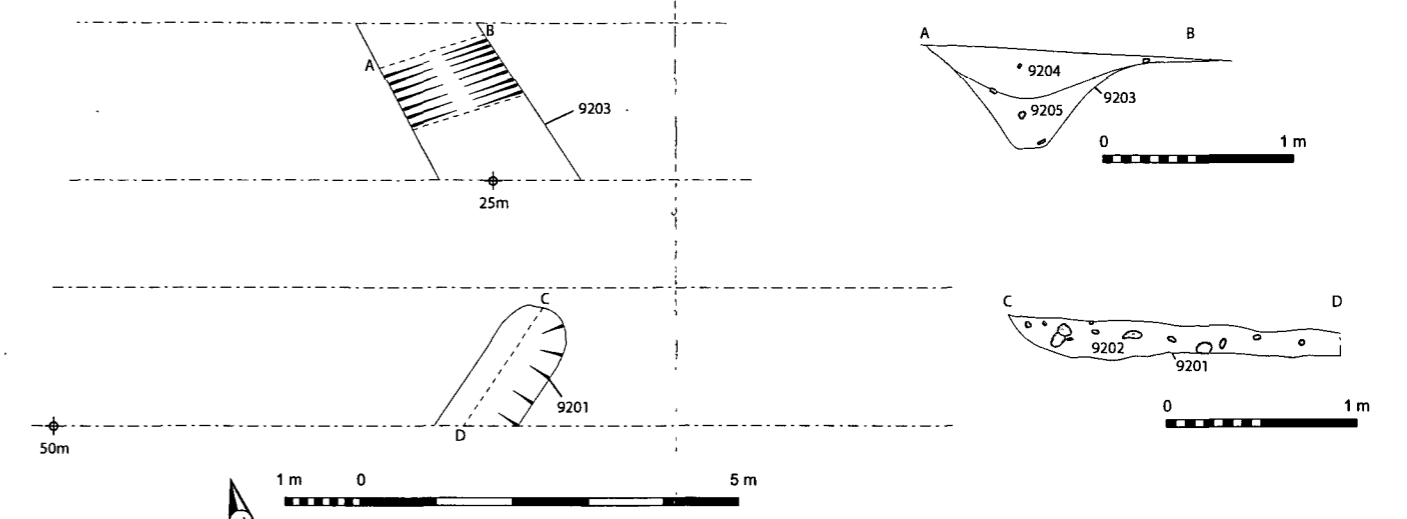

Plans and sections of features in Trench 92

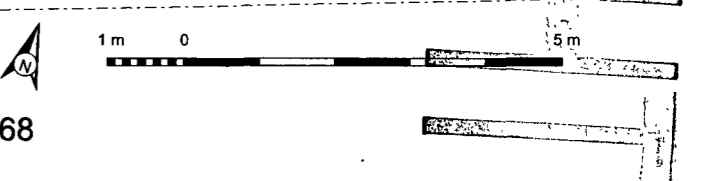

Plan and sections of features in of Trench 68

RECEIVED
PLANNING
20 SEP 2006
TO THE
SCARBOROUGH
AOC
ARCHAEOLOGY
GROUP

Figure 15: Plans and section of features in Trenches 68, 92 and 71

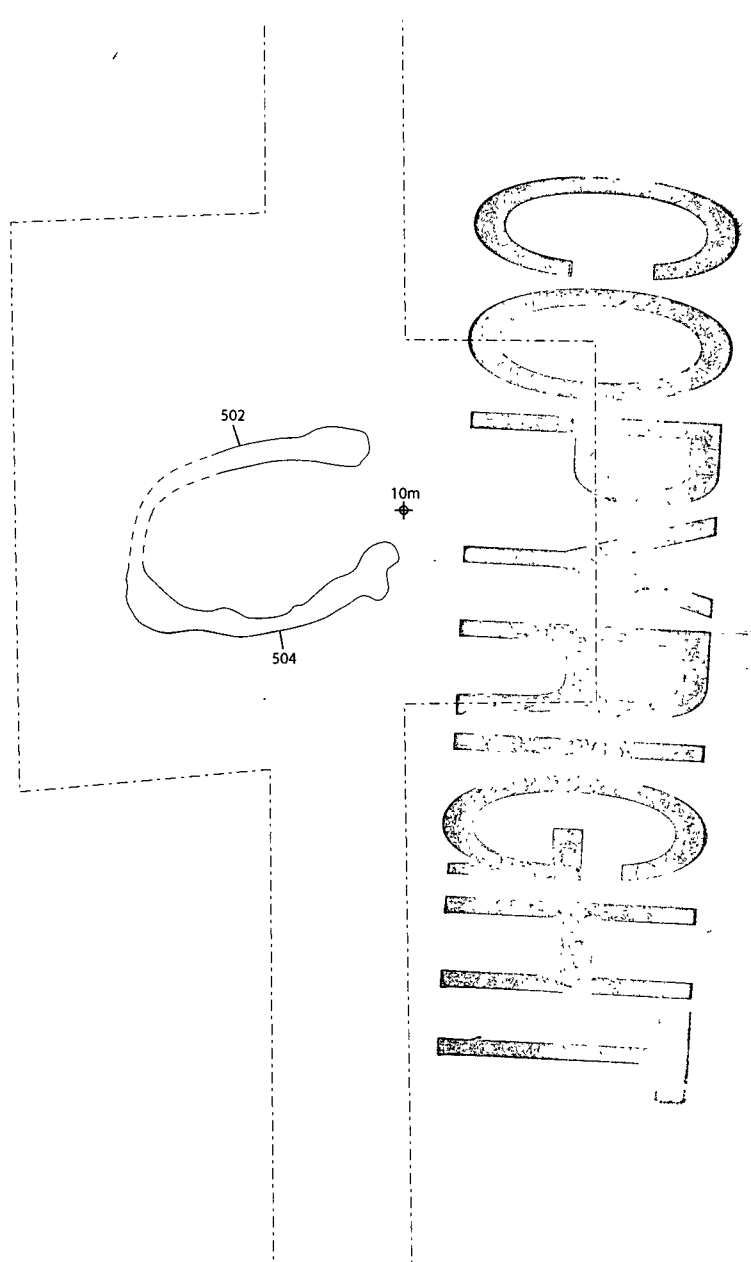
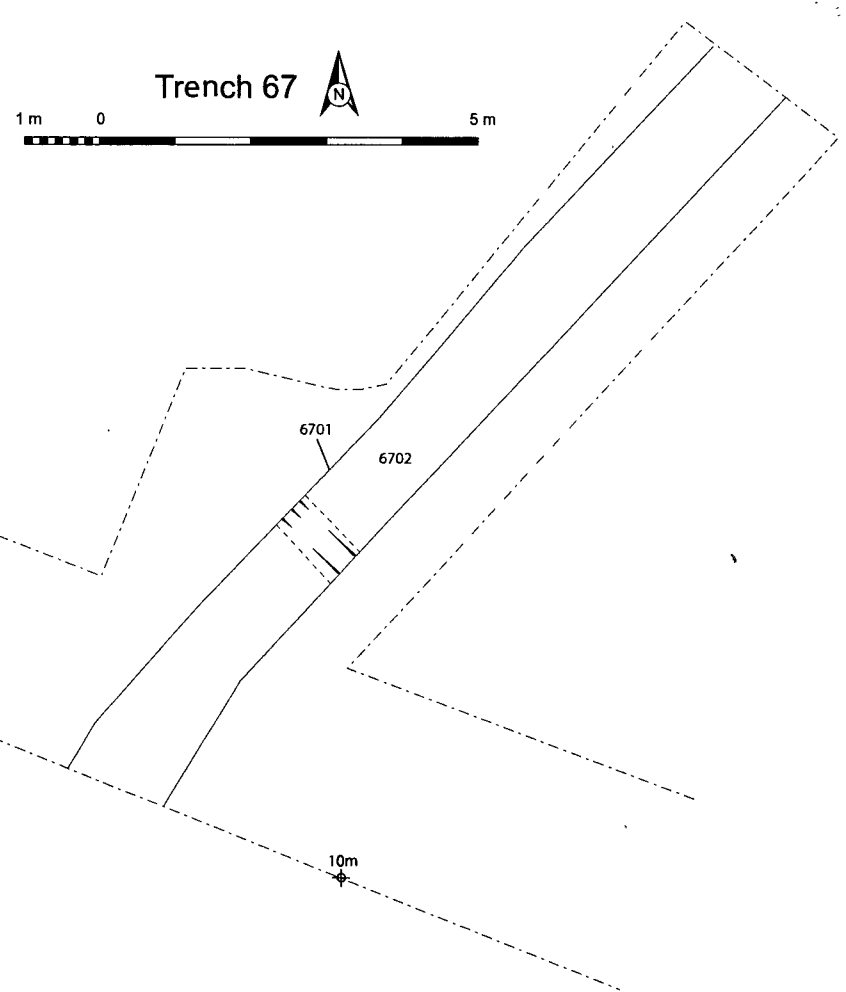
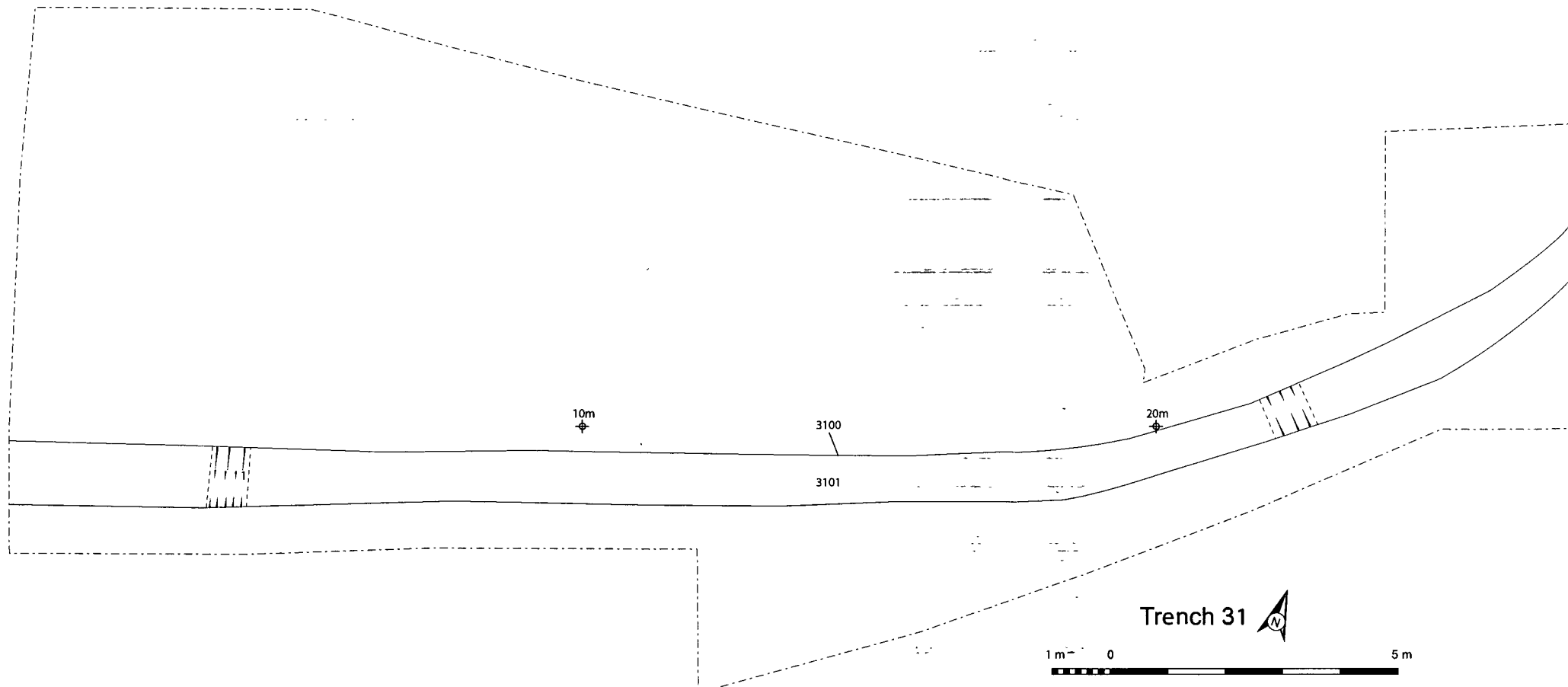

Trench 42

1 m 0

RECEIVED
 PLANNING SERVICES
 20 SEP 2006
 TOWN HALL
 SCARBOROUGH

Figure 16: Plans of features found in Trenches 31, 67 and 5

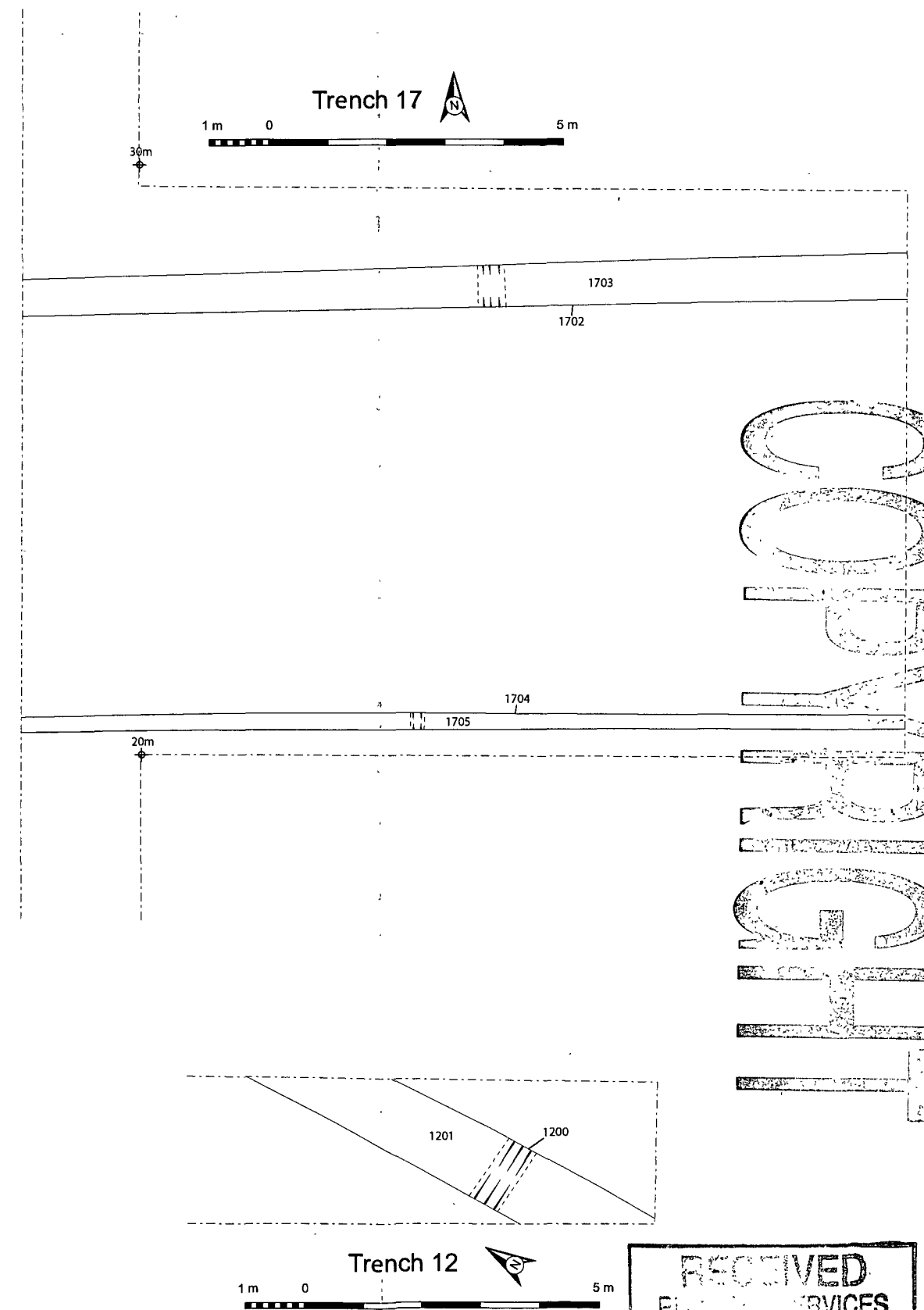
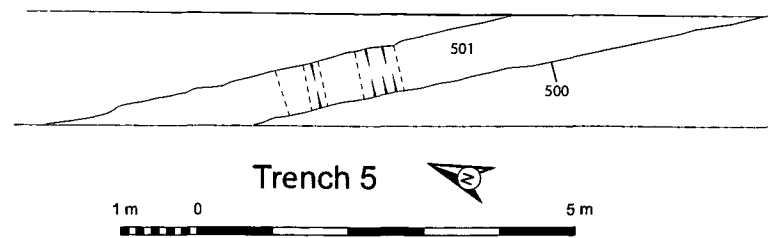
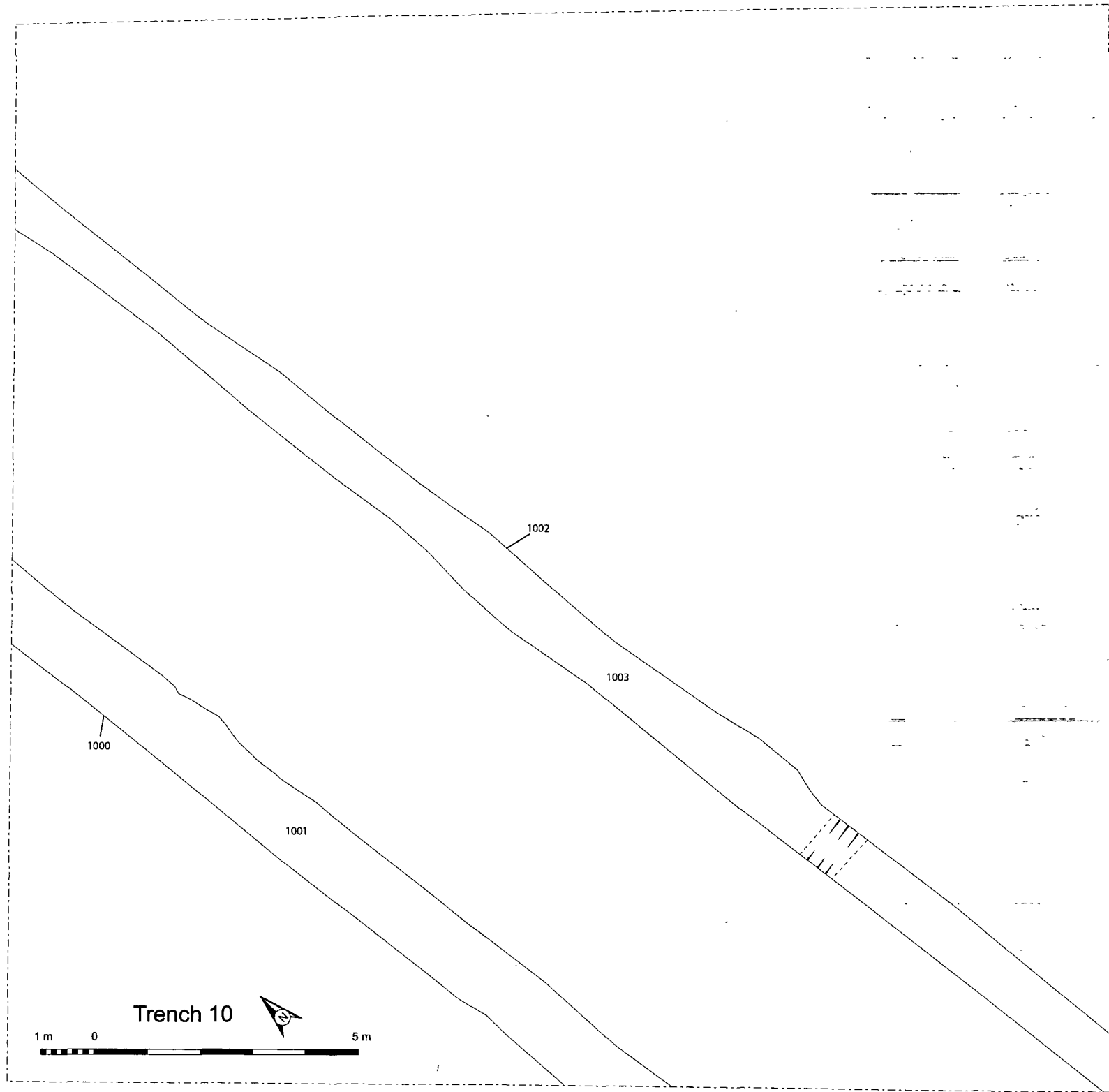

COPYRIGHT

Figure 17: Medieval and Post-medieval field boundaries

RECEIVED
 FIELD SERVICES
 20 SEP 2006
 TOYNALL
 SCARBOROUGH

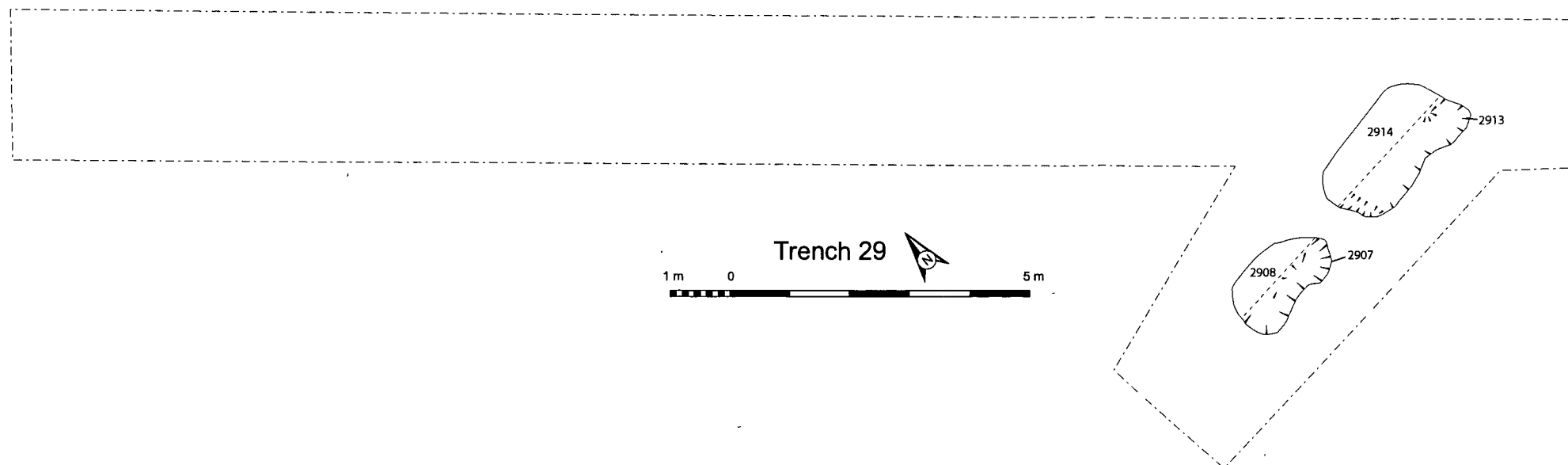
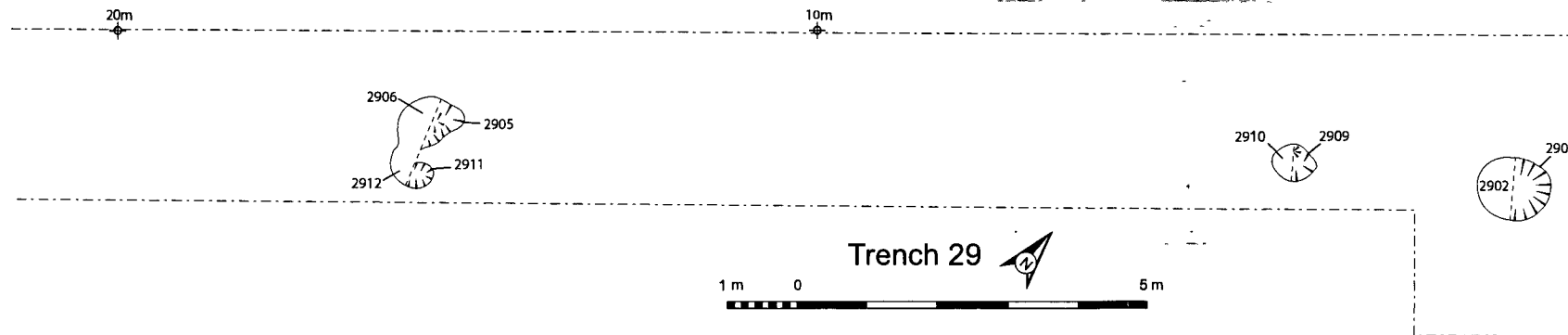
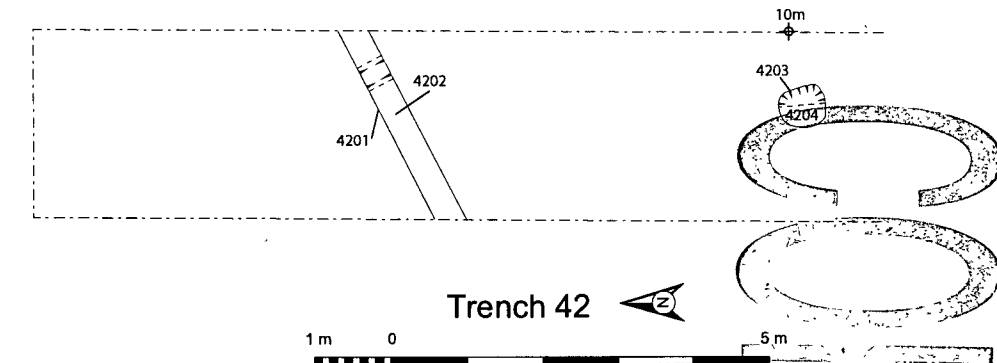
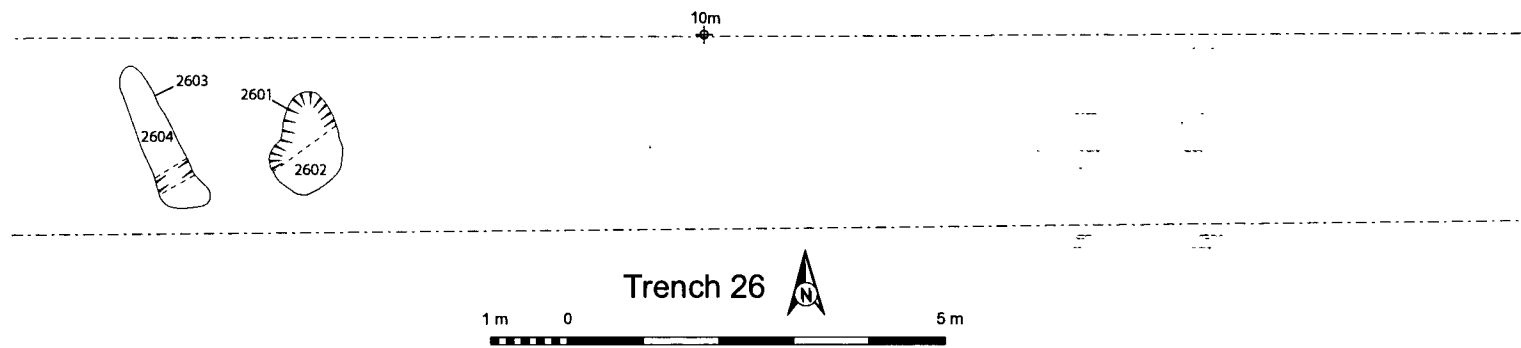
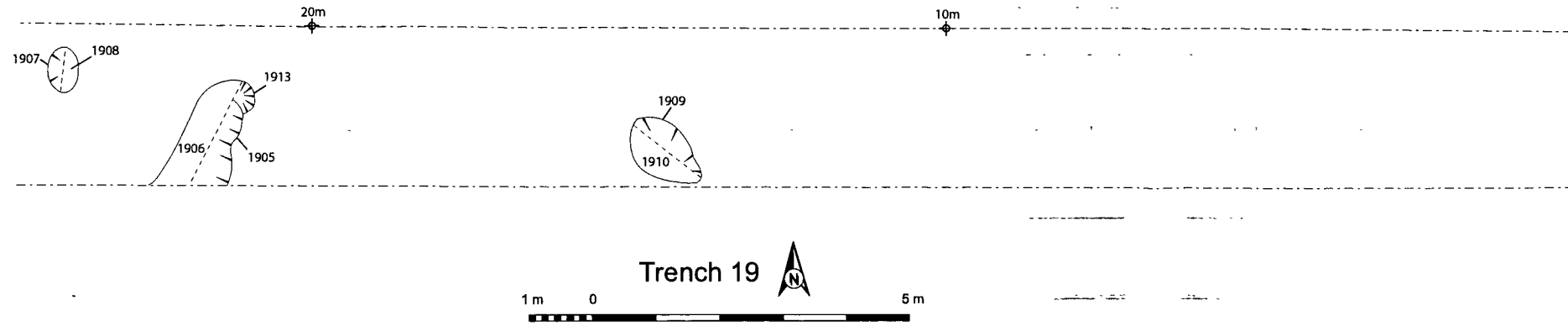

Figure 18: Undated features

RECEIVED
 PLANNING SERVICES
 20 SEP 2006
 TOWN HALL
 SCARBOROUGH

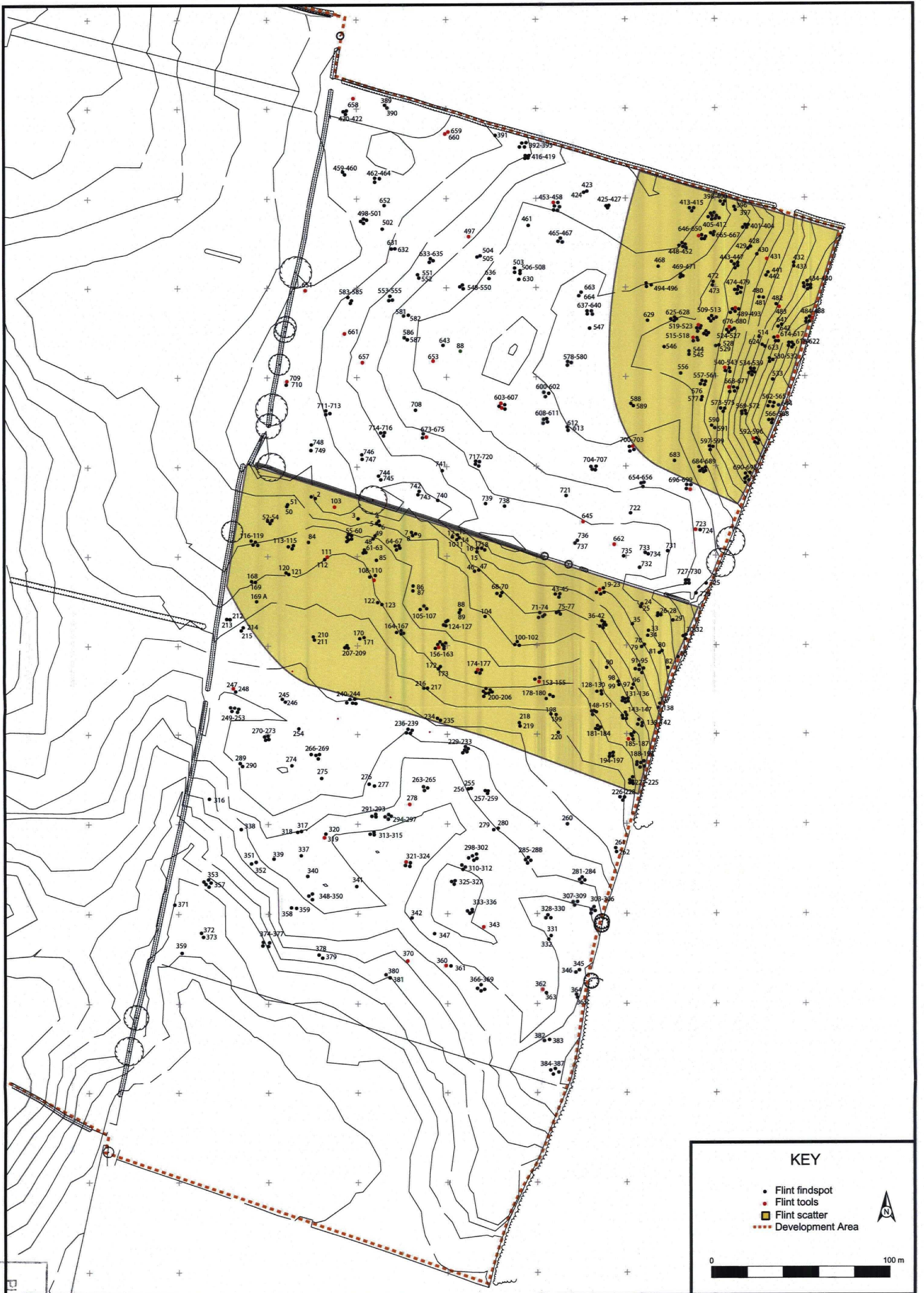

Figure 19: Field-walking survey results showing density of flint scatters

20 SEP 2006
 TOWN & COUNTRY
 SCARBOROUGH
 PL
 RECEIVED
 10/10/06

COPYRIGHT

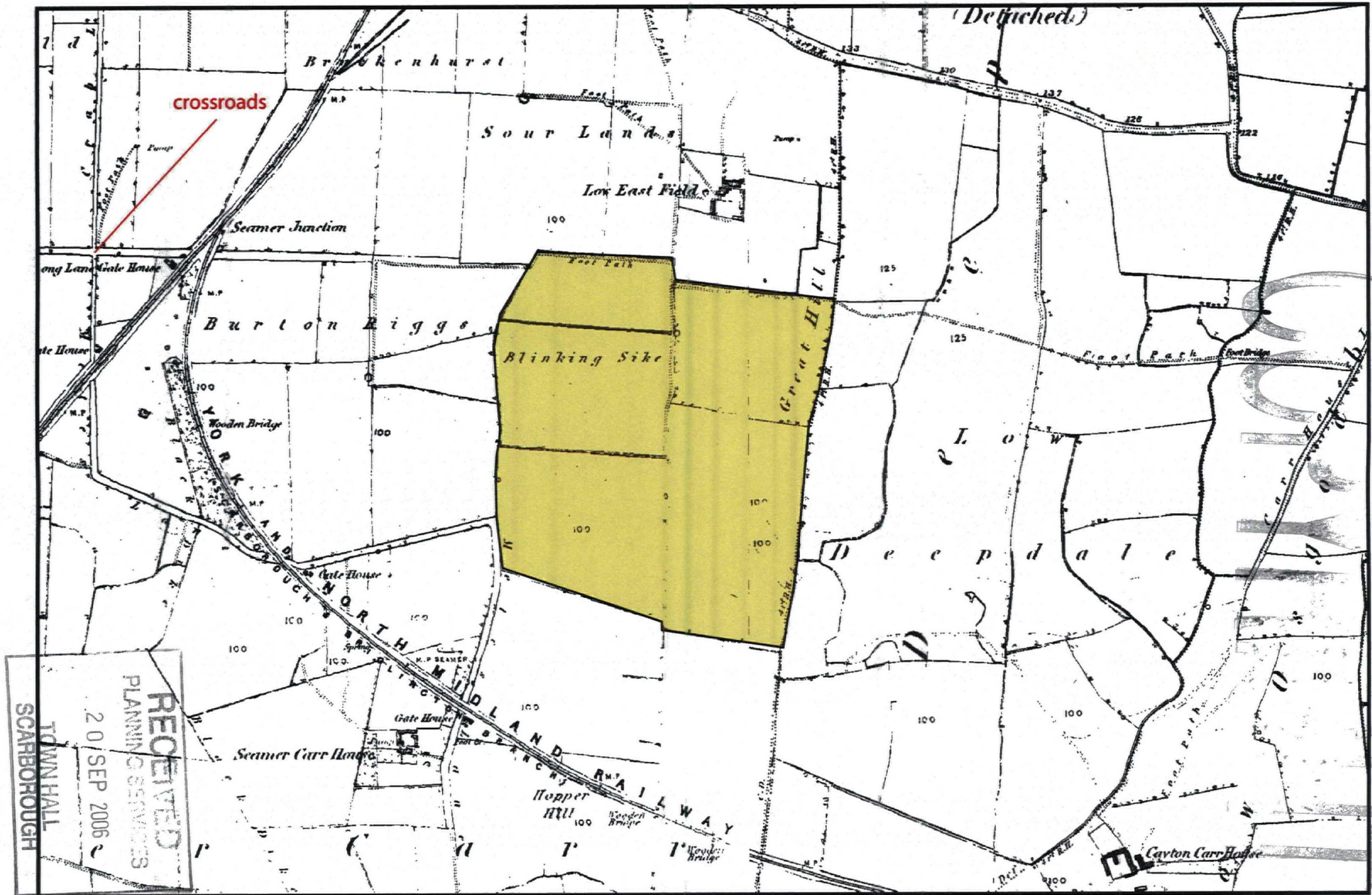



Figure 20 : Extract from map by Ordnance Survey, 1854

 approximate location of site

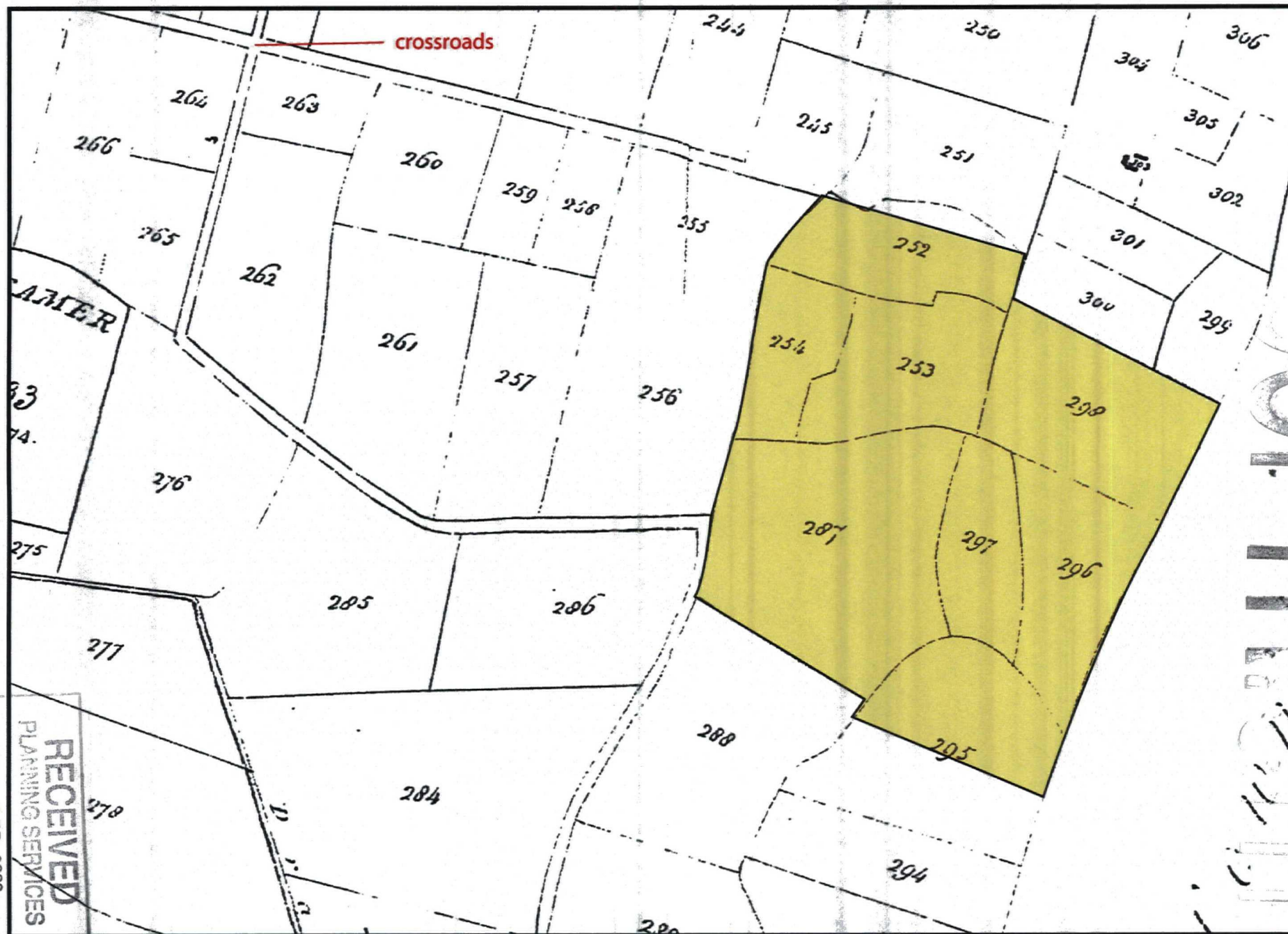

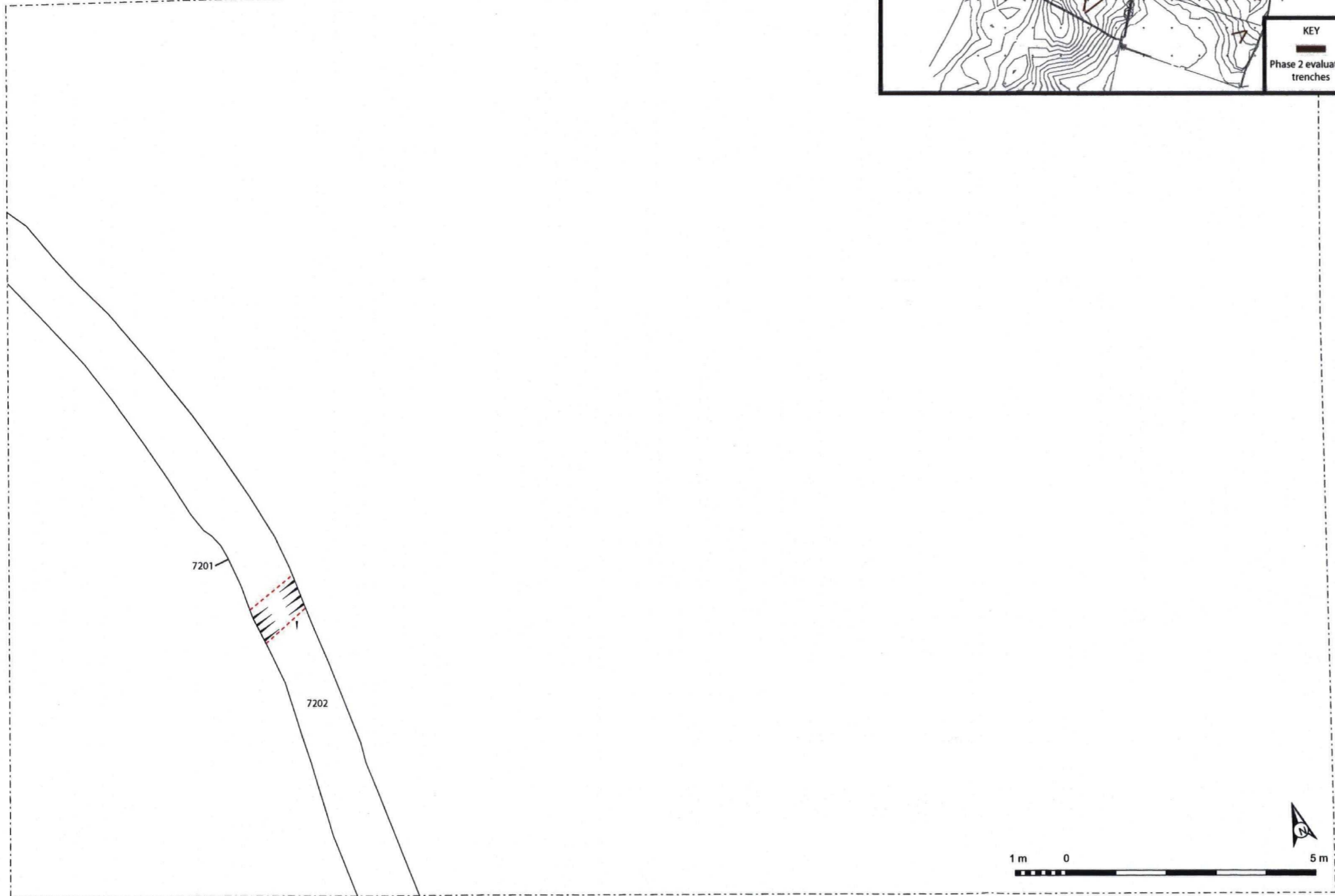
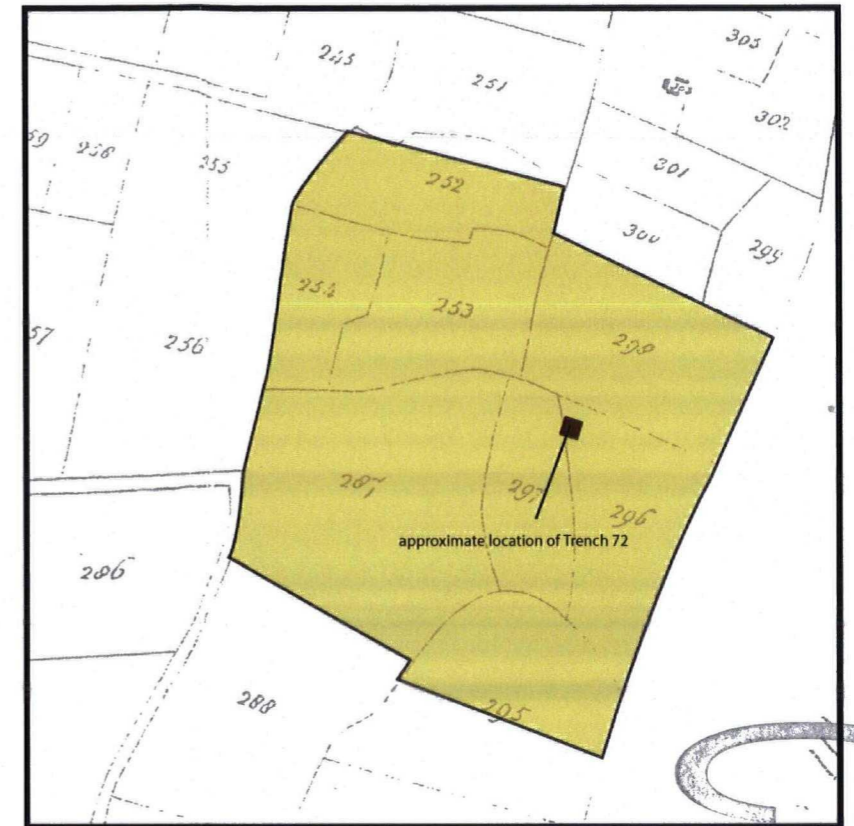

Figure 21 : Extract from map by Seamer and Irton, 1810

 approximate location of site



Plan of features in of Trench 72



Extract of map by Seamer and Irton, 1810

Figure 22: Possible boundary shown on 1810 map

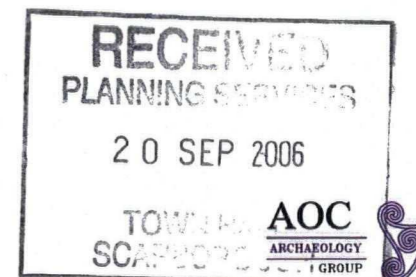

COPYRIGHT

COPYRIGHT

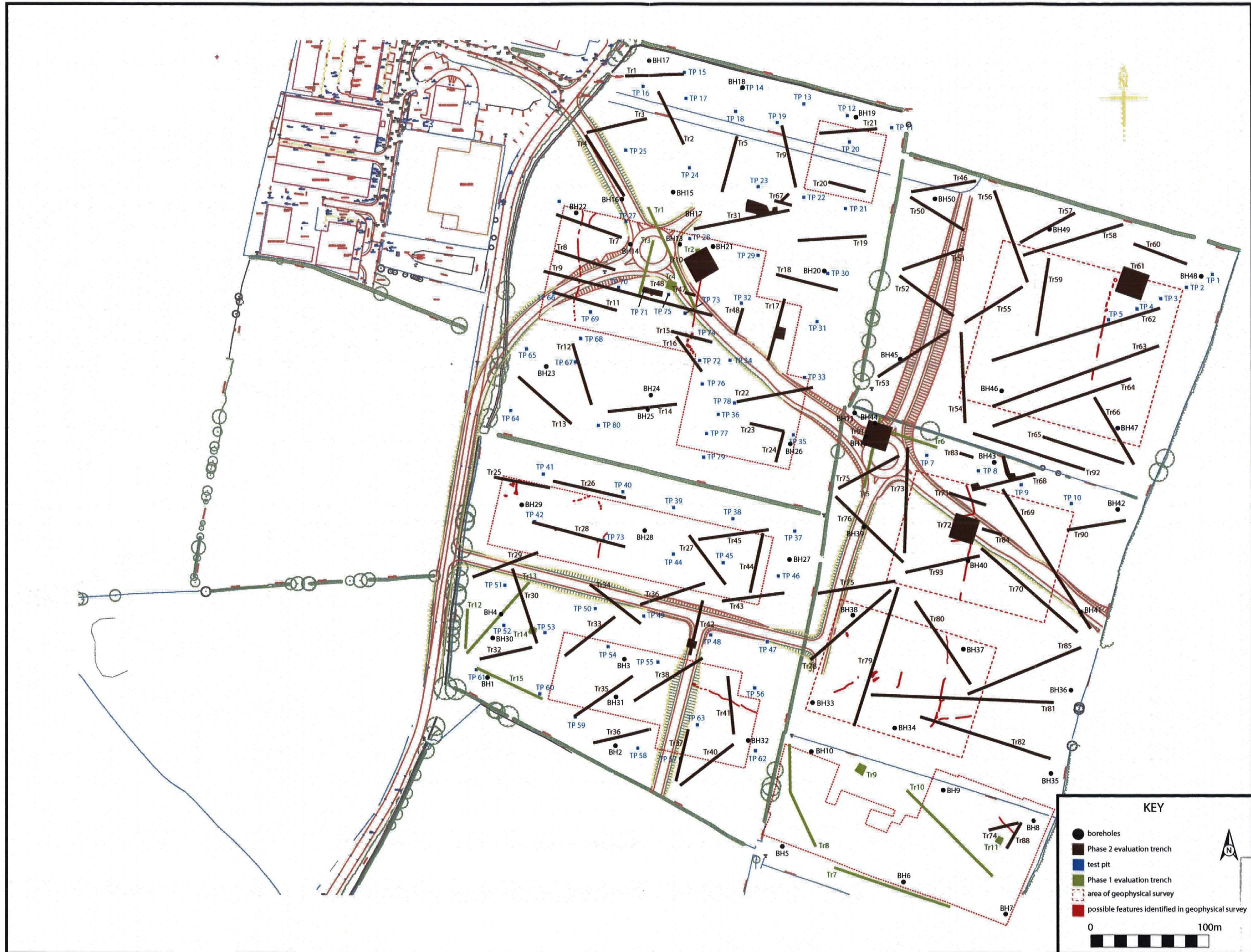

Figure 23: Site showing proposed Phase 1 works and archaeological works

GREEN
RING SEI
20 SEP 2000
TOWN HA
SCARBORC
AOC
ARCHAEOLOGY
GROUP