

Figure 1. Site Location.



Figure 2. Previous Excavation Trenches.



Figure 3. Trench Location Plan.

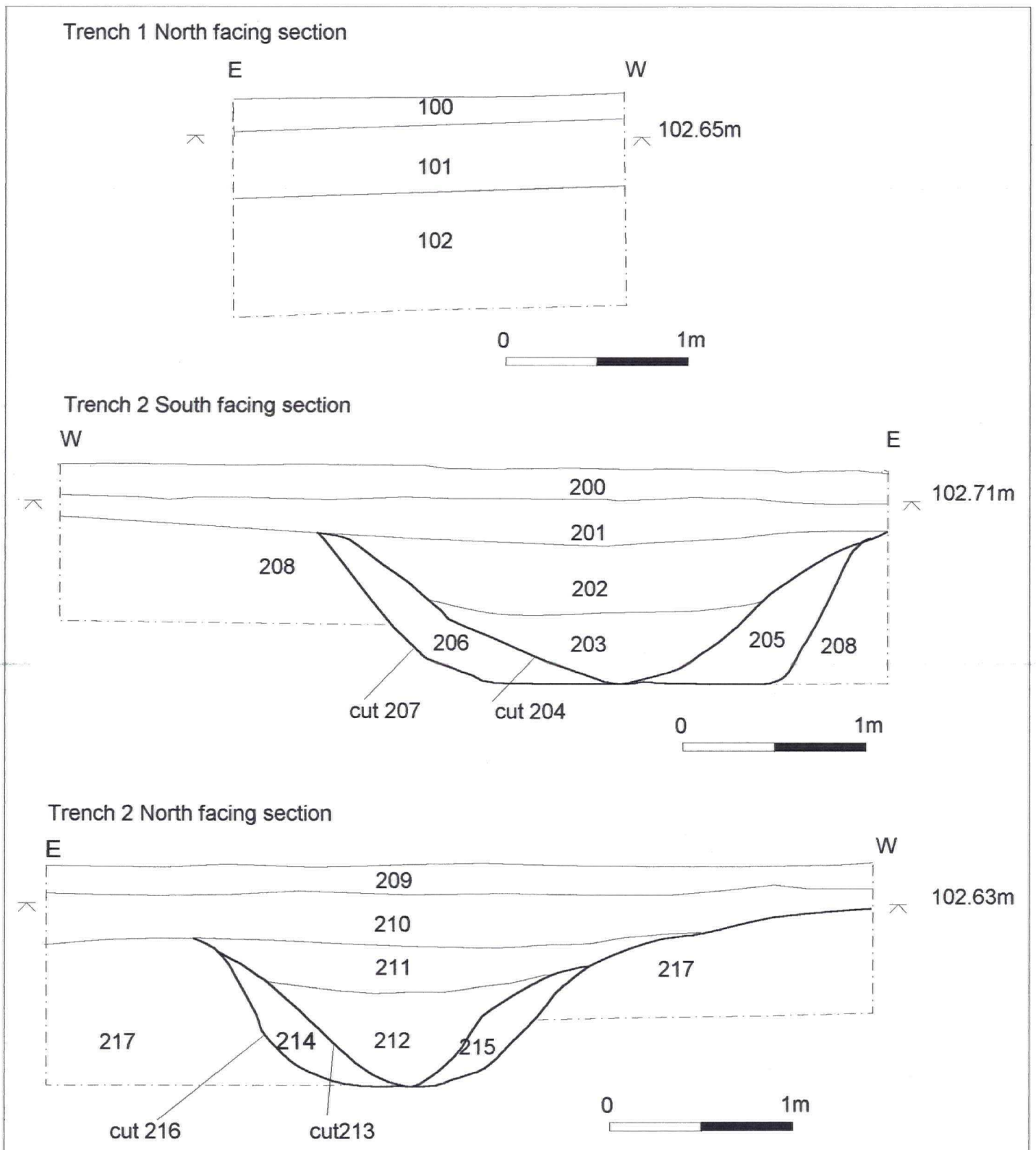

Figure 4. Trenches 1 and 2 Sections.

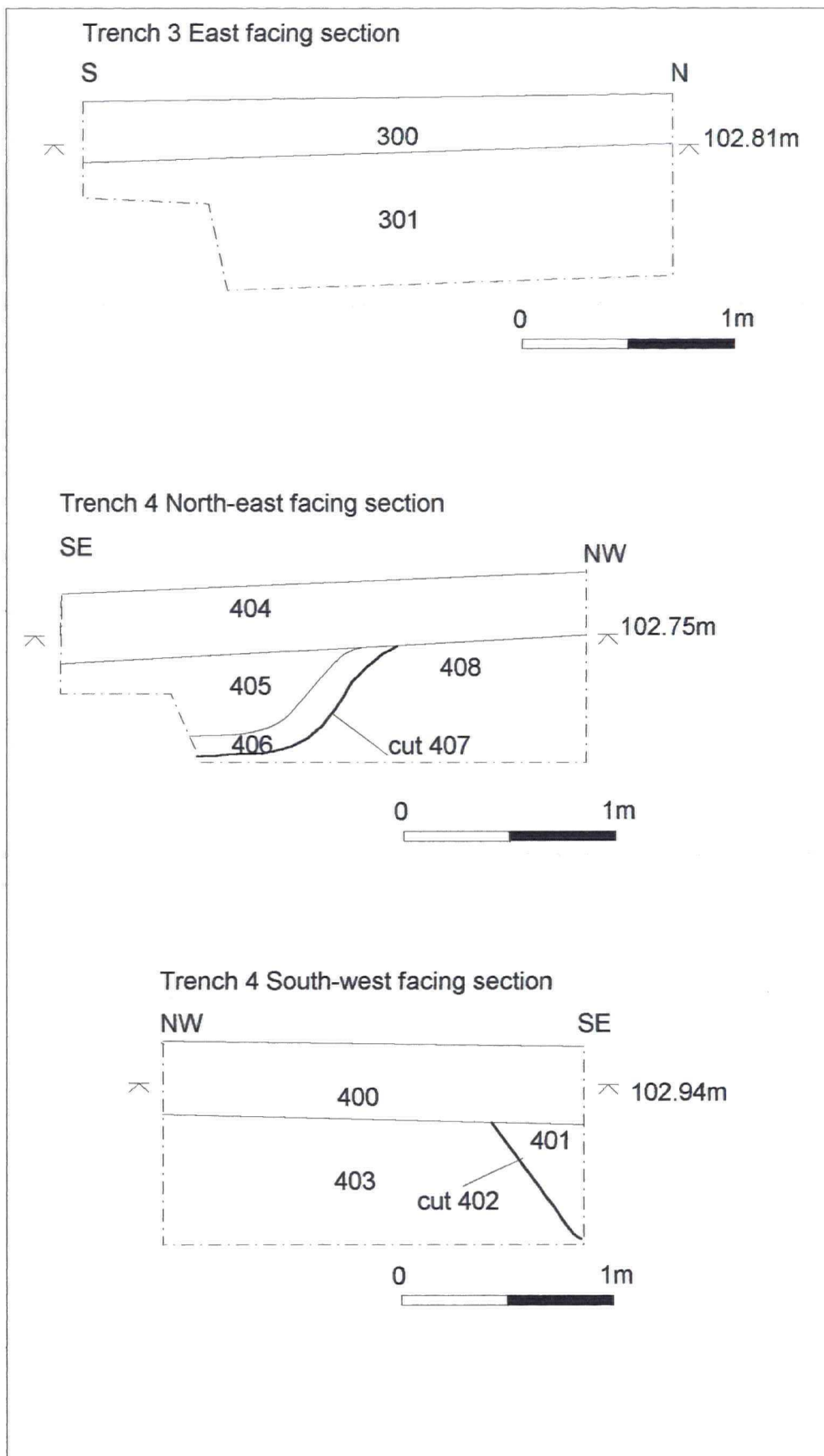

Figure 5. Trenches 3 and 4 Sections.

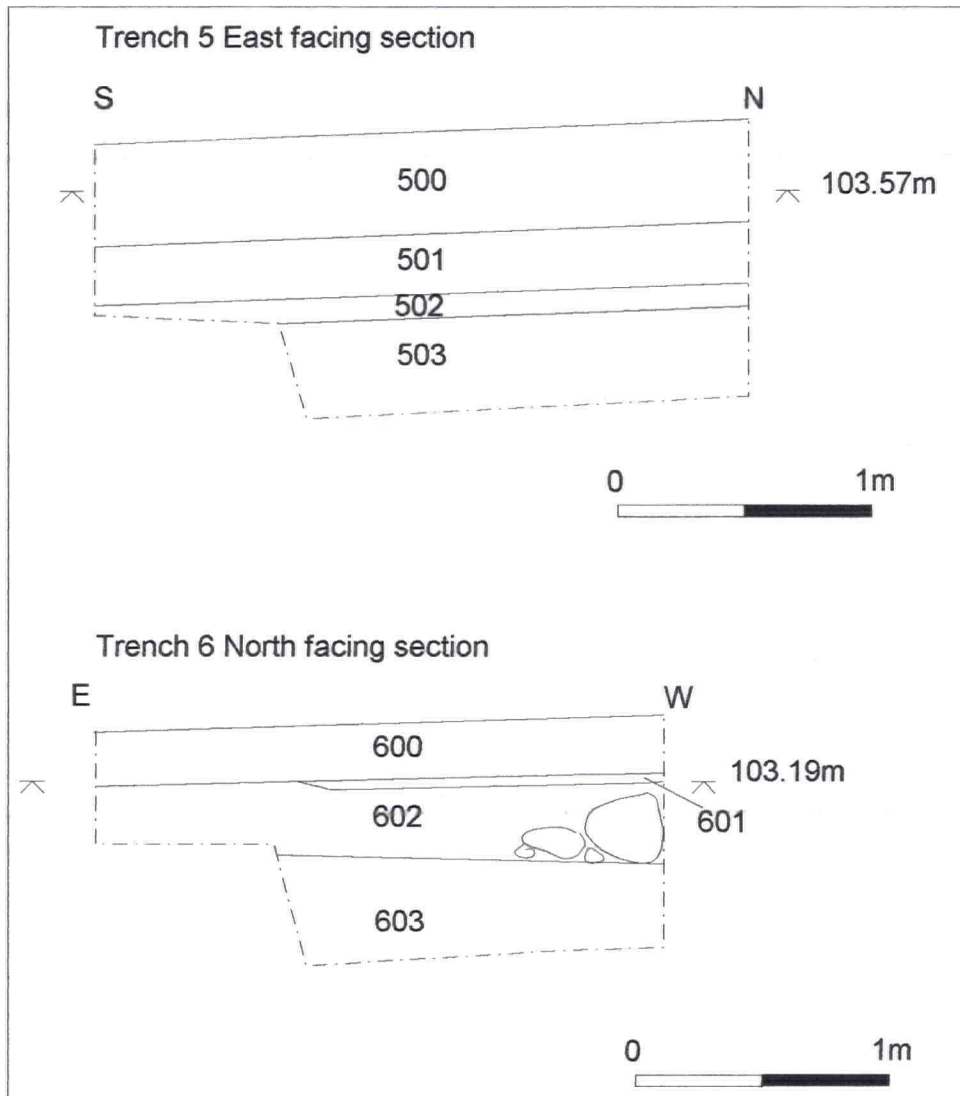

Figure 6. Trenches 5 and 6 Sections.

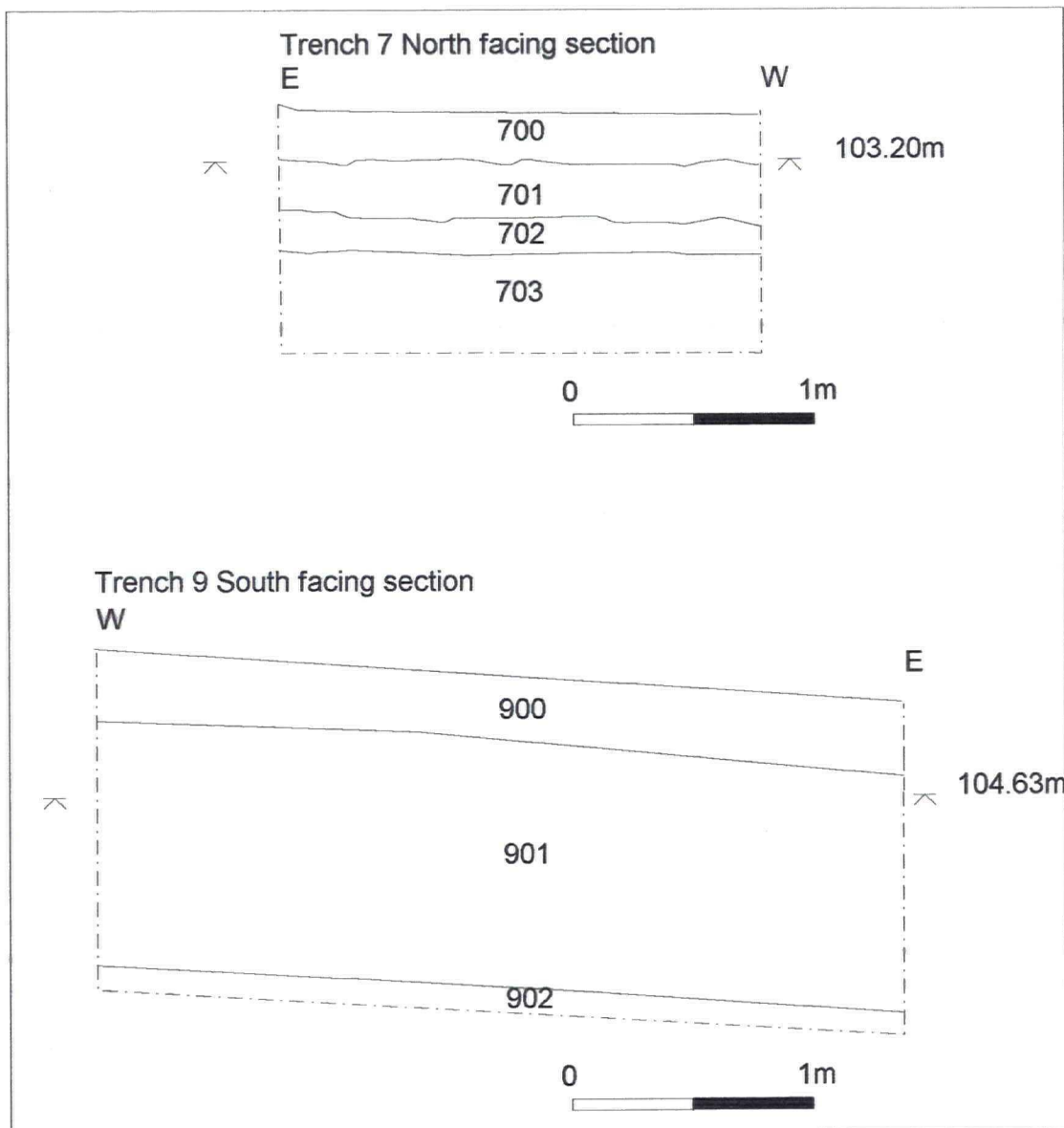

Figure 7. Trenches 7 and 9 Sections.

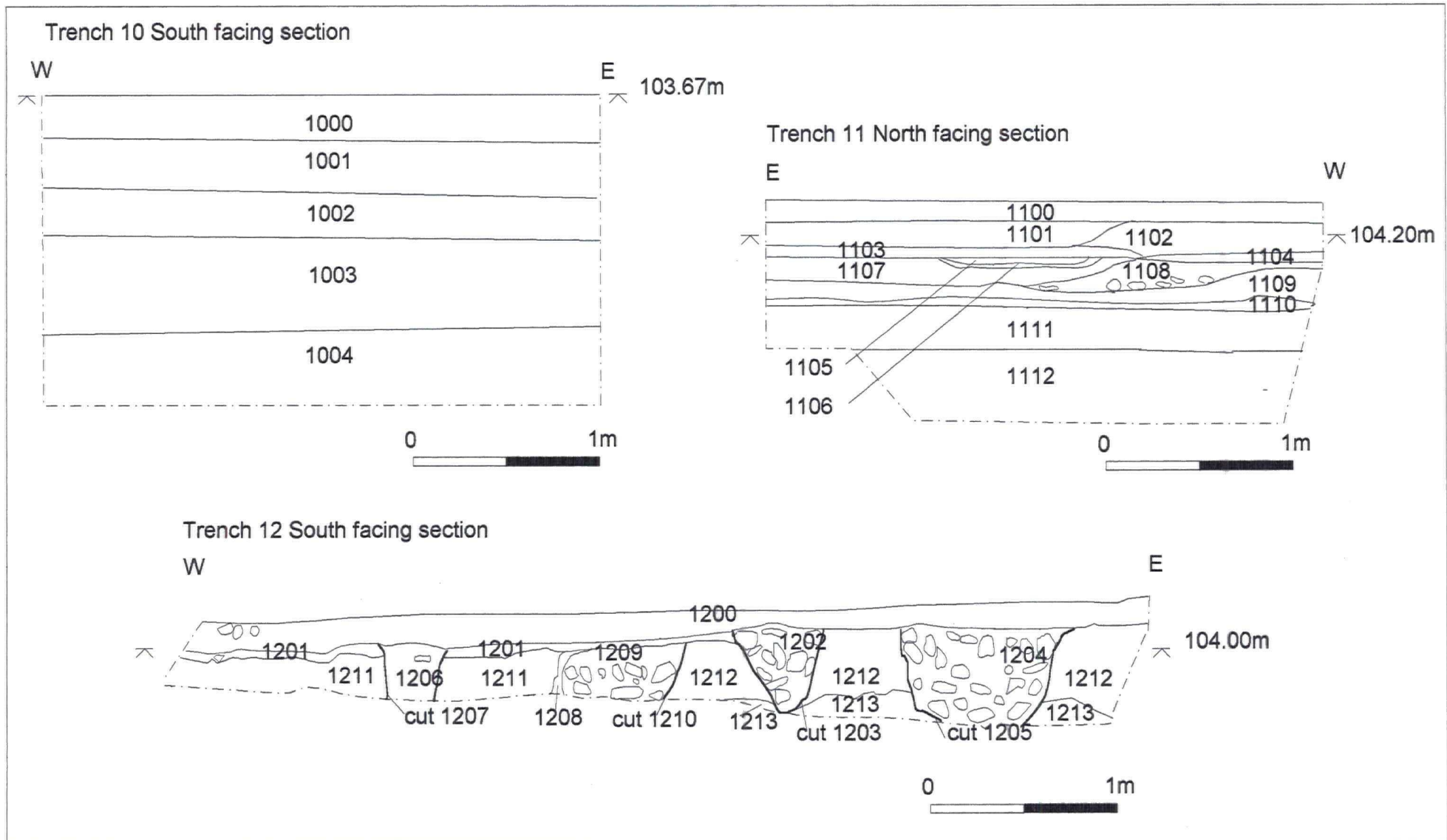

Figure 8. Trenches 10, 11 and 12 Sections.

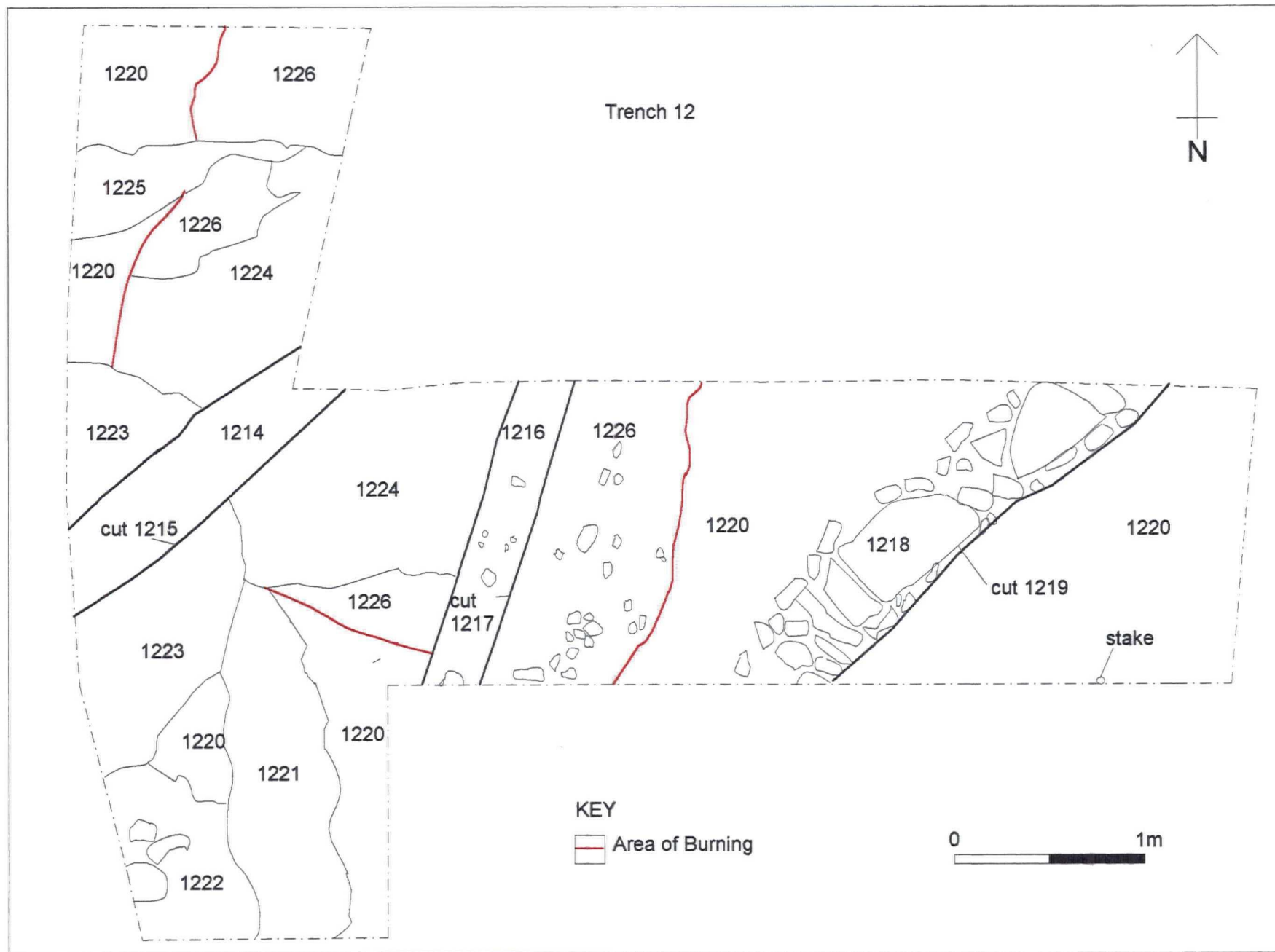

Figure 9. Trench 12 Plan.



Figure 10. Development plan in relation to Archaeological Work.

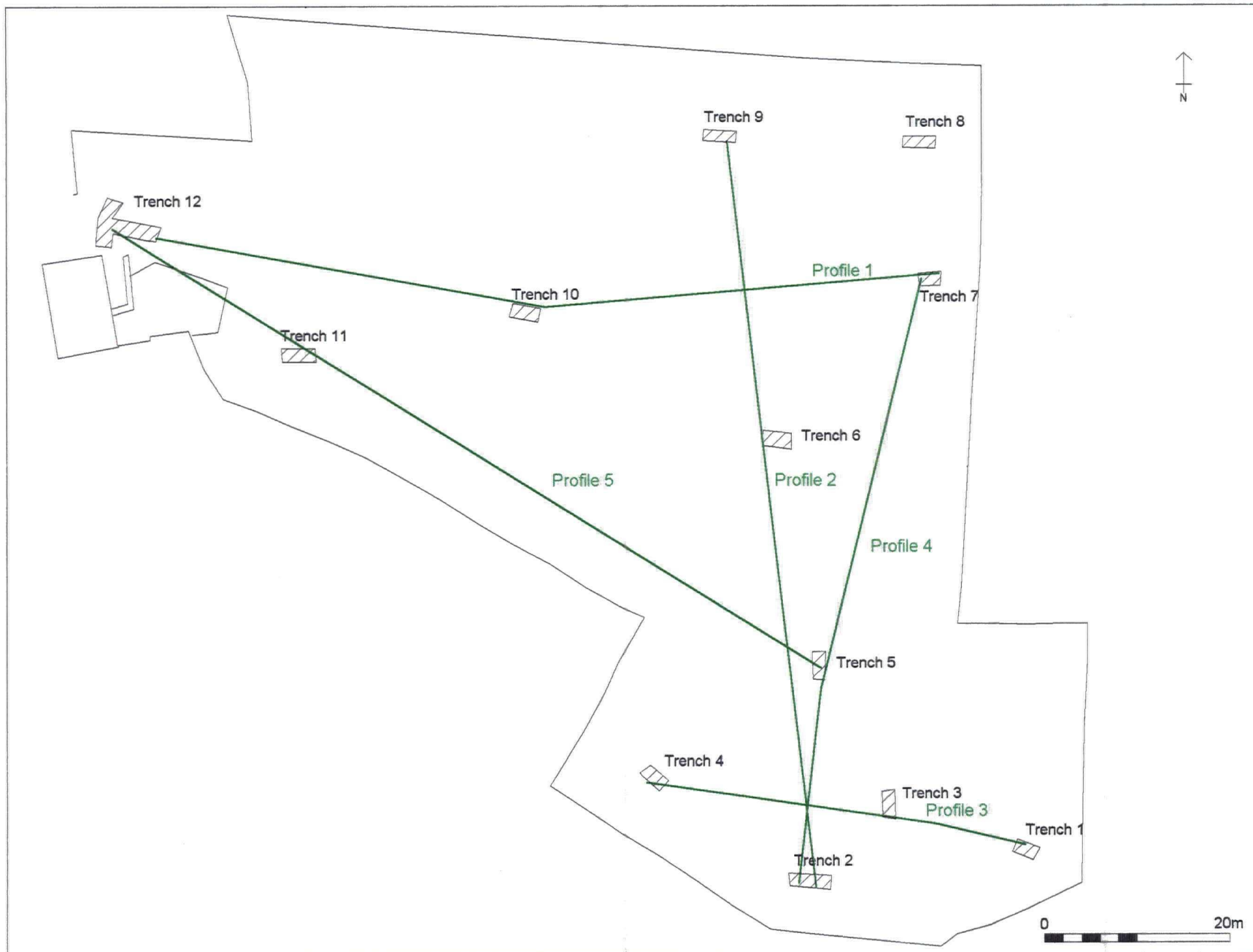

Figure 11. Location of Profile Data (Profiles 1 to 5).

WEST STREET - GARGRAVE

Deposit Model

Profile 1

	Tr 12	Tr 10	Tr 7
Ground level	104.30	103.67	103.40
Top of archaeology	104.10	103.13	103.20
Top of natural	103.74	103.13	102.80

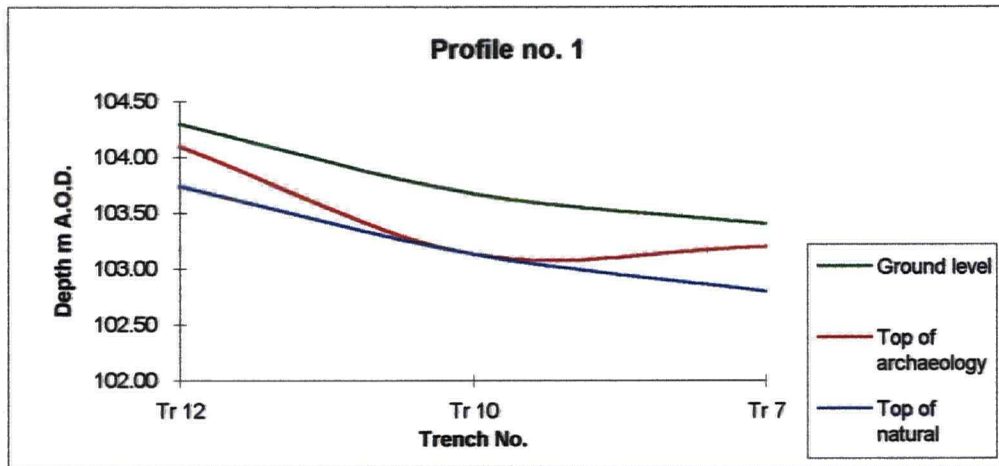

Profile 2

	Tr 9	Tr 6	Tr 2
Ground level	105.26	103.47	102.85
Top of archaeology	103.73	103.23	102.62
Top of natural	103.43	102.89	102.62

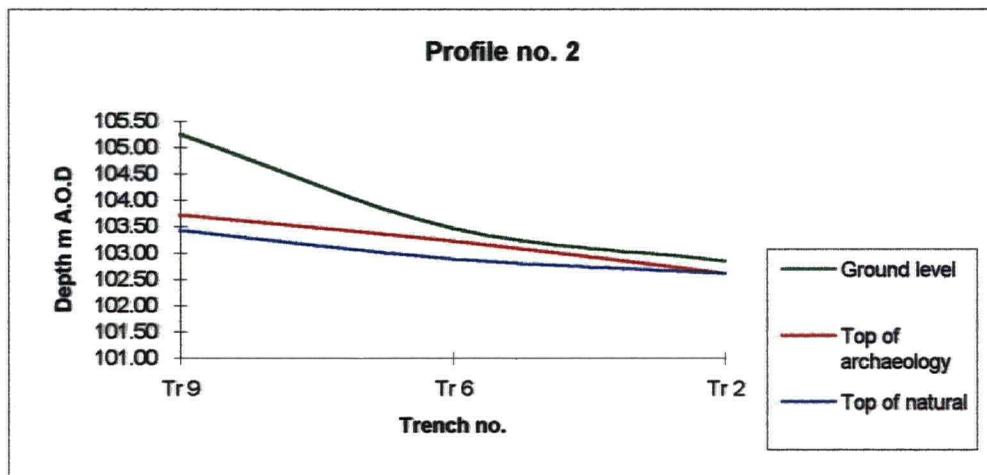

Figure 12.

WEST STREET - GARGRAVE

Deposit Model

Profile 3

	Tr 1	Tr 3	Tr 4
Ground level	102.91	103.05	103.12
Top of archaeology	102.55	102.81	102.78
Top of natural	102.35	102.81	102.78

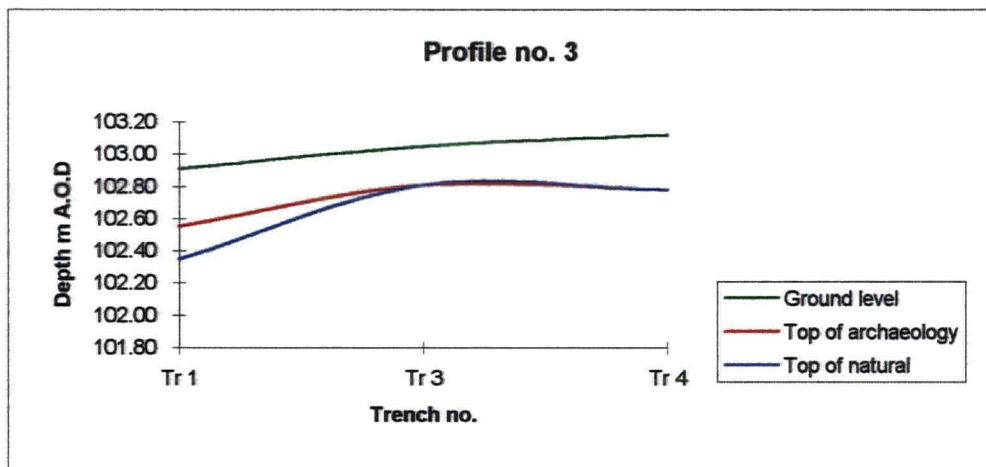

Profile 4

	Tr 2	Tr 5	Tr 7
Ground level	102.85	103.87	103.40
Top of archaeology	102.61	103.67	102.80
Top of natural	102.61	102.67	102.80

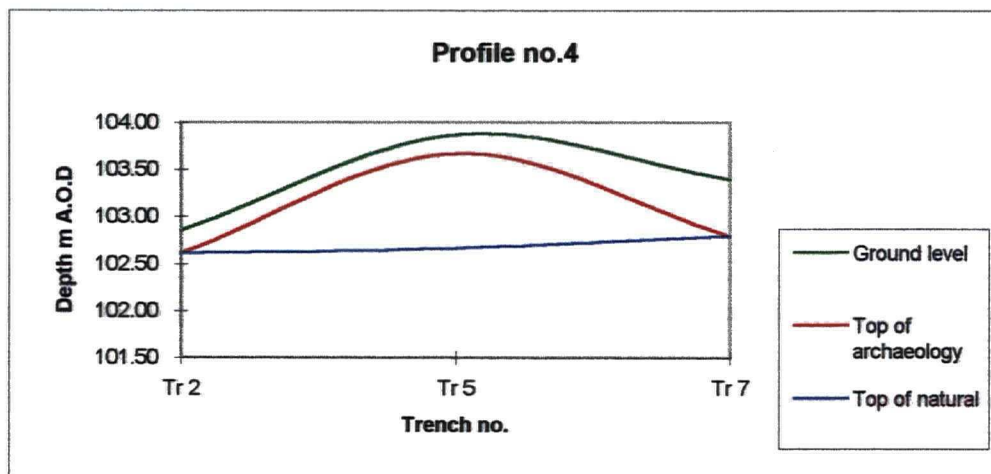

Figure 13

WEST STREET - GARGRAVE

Deposit Model

Profile 5

	Tr 12	Tr 11	Tr 5
Ground level	104.30	104.36	103.87
Top of archaeology	104.10	104.24	103.67
Top of natural	103.74	103.60	102.67

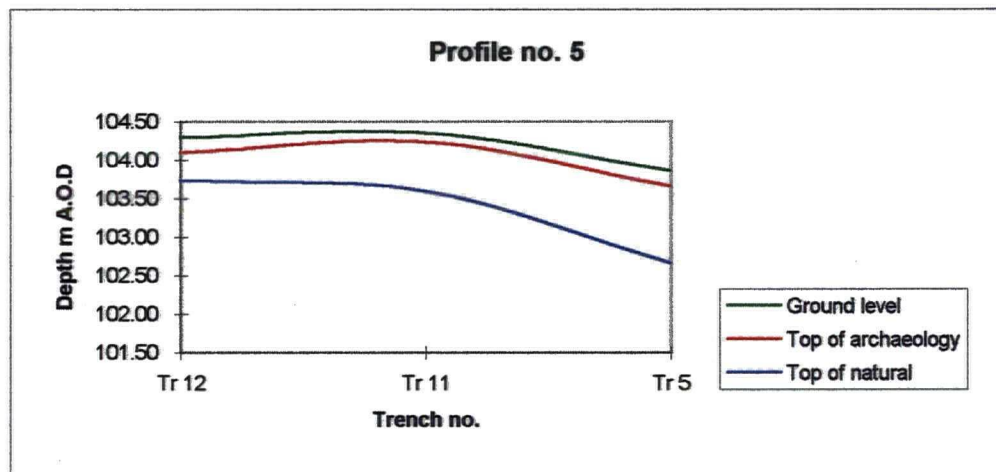

Figure 14.

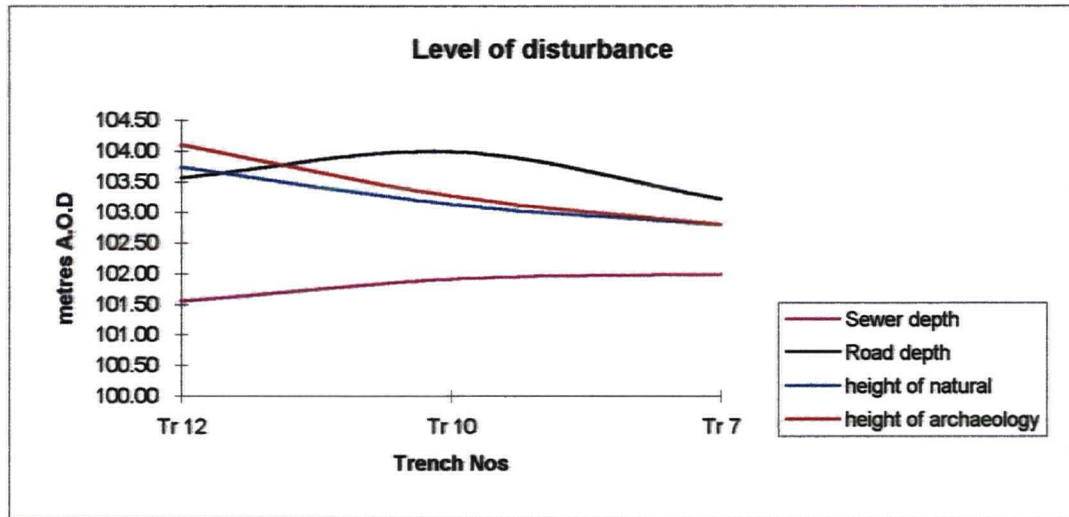

Figure 15. Location of Disturbance Data.

West Street - Gargrave

Development implications

	Tr 12	Tr 10	Tr 7
Sewer depth	101.55	101.91	102.00
Road depth	103.56	103.99	103.21
height of natural	103.74	103.13	102.80
height of archaeology	104.10	103.27	102.80



	Tr 3	Tr 5	Tr 6
Sewer depth	102.50	102.50	102.10
Road depth	102.96	102.96	102.96
Height of natural	102.81	102.83	102.89
Height of archaeology	102.81	103.67	103.19

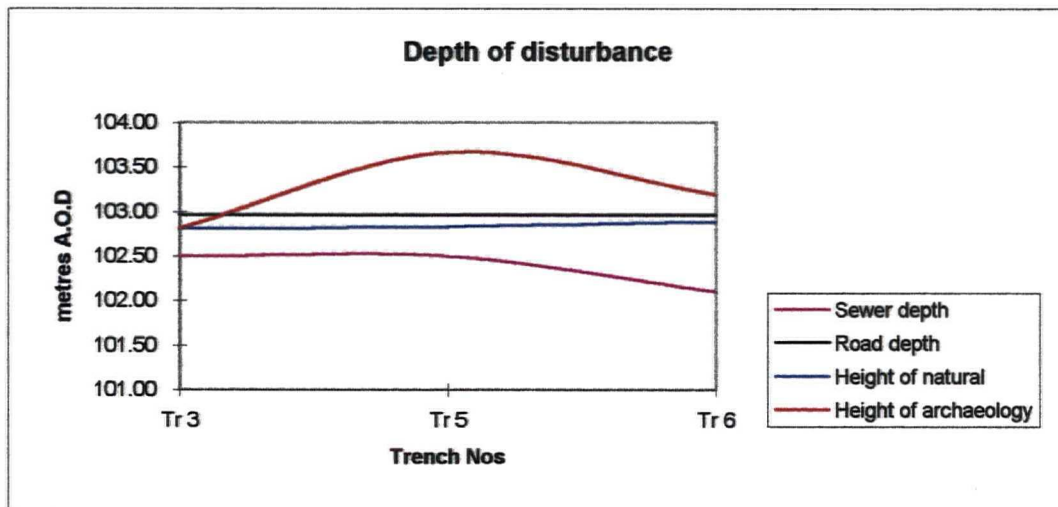

Figure 16.

West Street - Gargrave

Development implications

House No.	6C	7E	8C	9C	10C	11C	12C
Topsoiled ground level	103.28	103.04	102.75	102.95	103.74	103.58	103.93
Level for ground beam	104.15	103.70	103.70	104.15	104.45	104.30	104.90

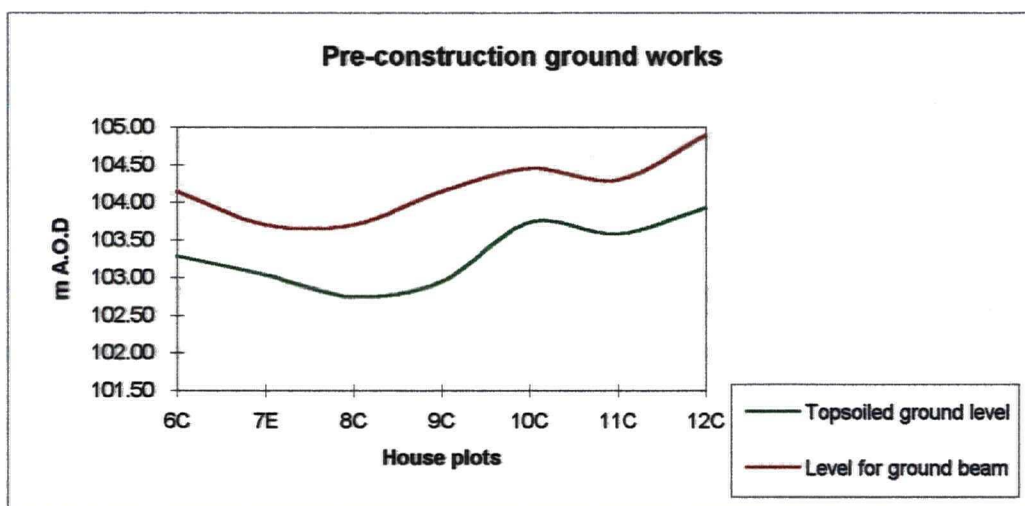

Figure 17