

Trench 52 Section
Scale 1.25

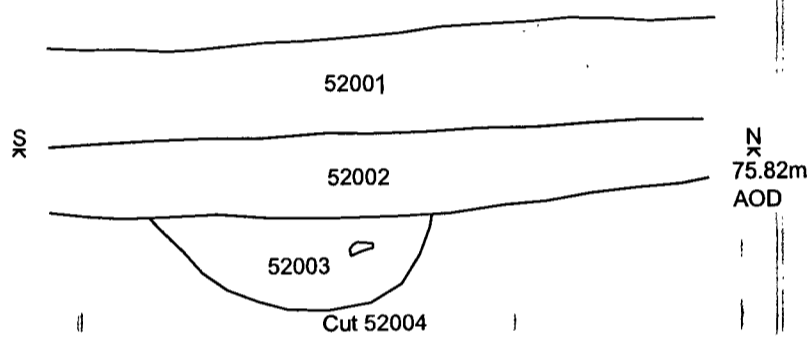

Cut
52003
52003

<p>MAP Archaeological Consultancy Ltd.</p>	<p>TITLE: Plan & Section Of Trench 52</p>
<p>SITE: Middle Deepdale, Scarborough</p>	<p>FIGURE:21 Scale: 1:100</p>
<p>CLIENT: Kebbelle Development Ltd & Scarborough Borough Council</p>	<p>DRAWING REF.:</p>
	<p>DRAWN BY: TWS</p>
	<p>REVISIONS:</p>

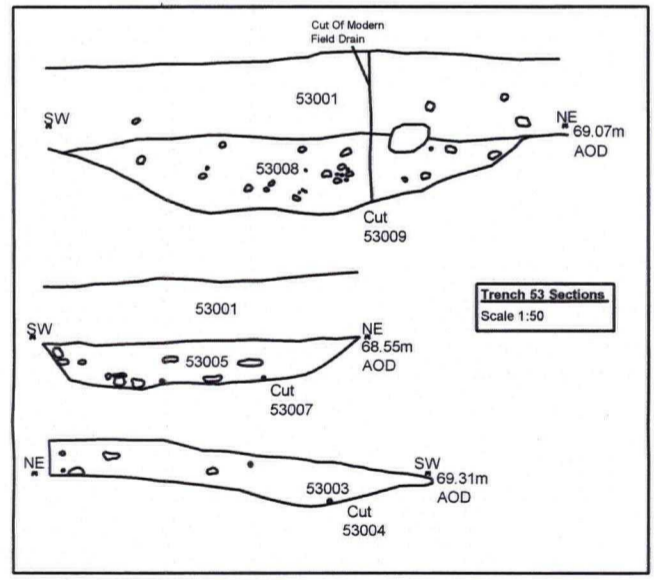
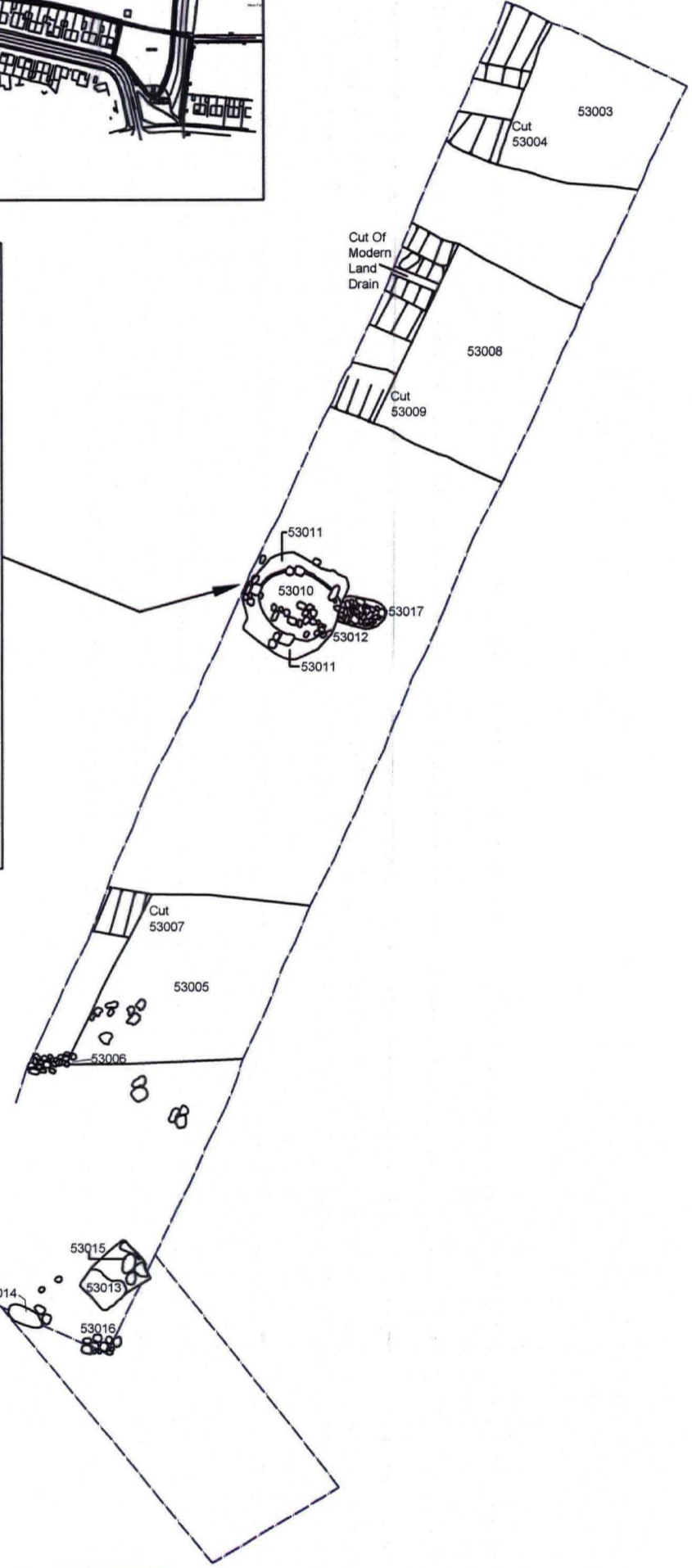
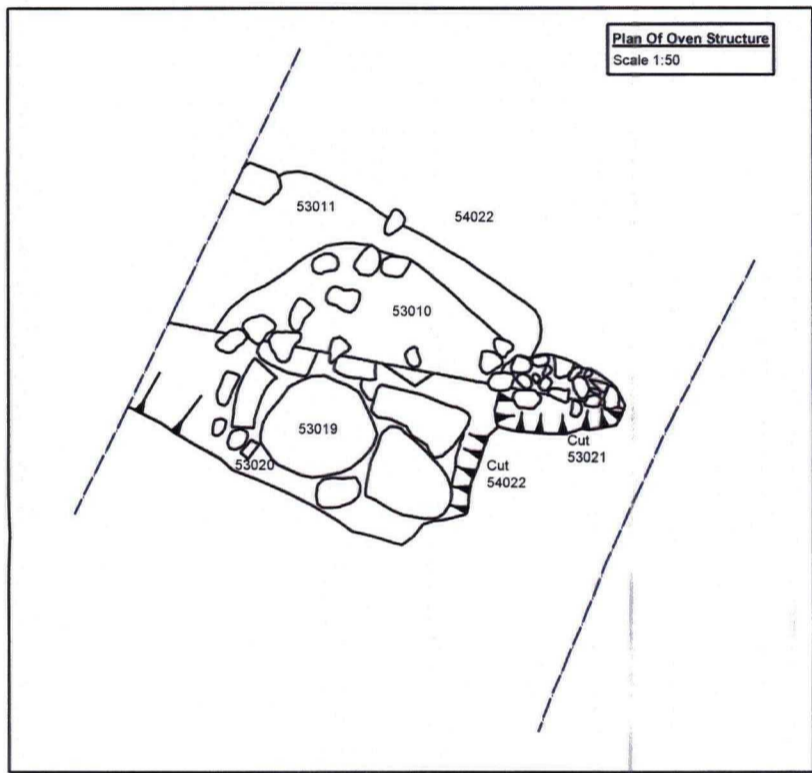
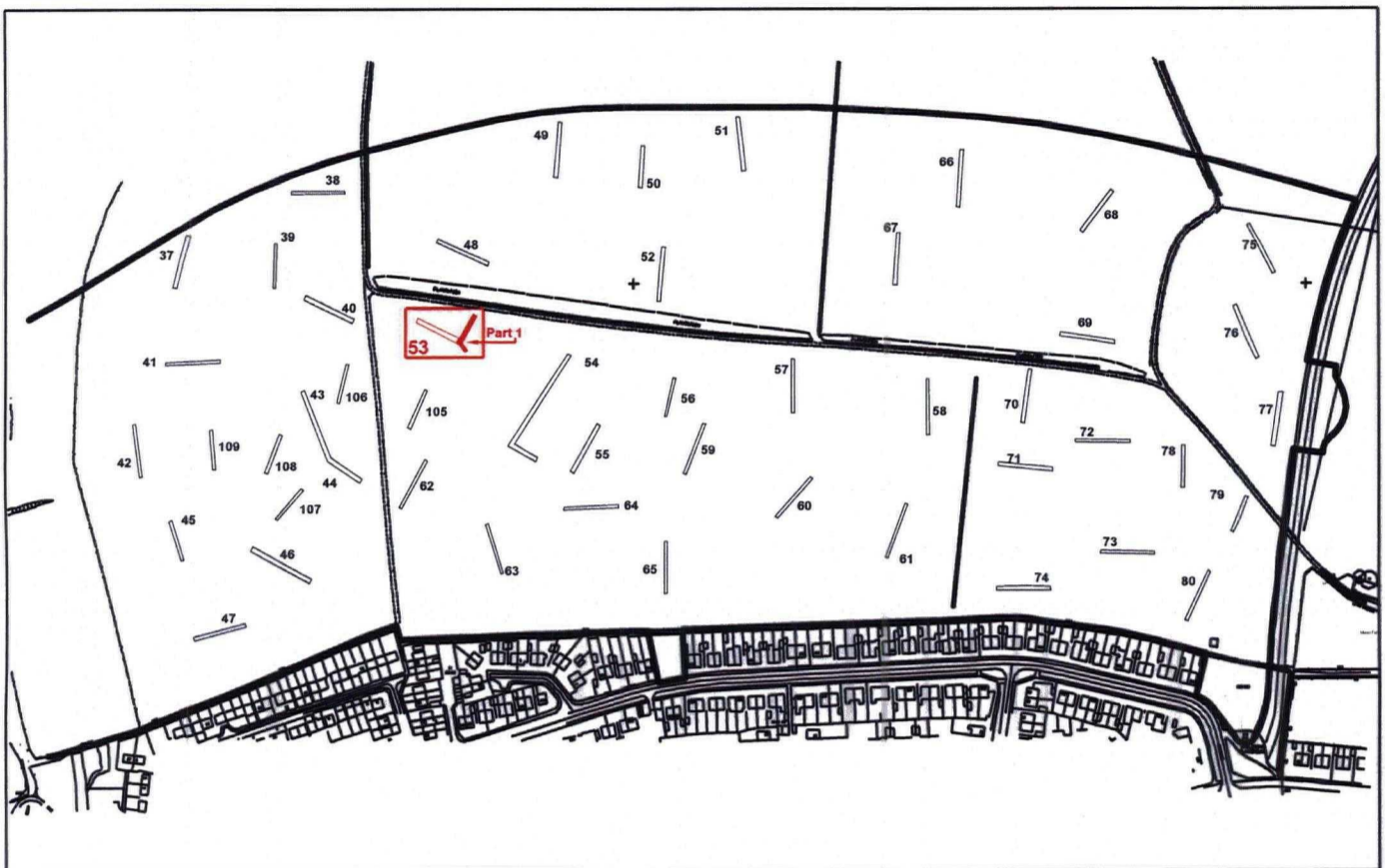

MAP
Archaeological Consultancy Ltd.

SITE: Middle Deepdale, Scarborough

CLIENT: Kebbelle Development Ltd & Scarborough Borough Council

TITLE: Plan Of Trench 53 (Part 1)

FIGURE: 22 | **Scale: 1:100**

DRAWING REF.:

DRAWN BY: TWS

REVISIONS:

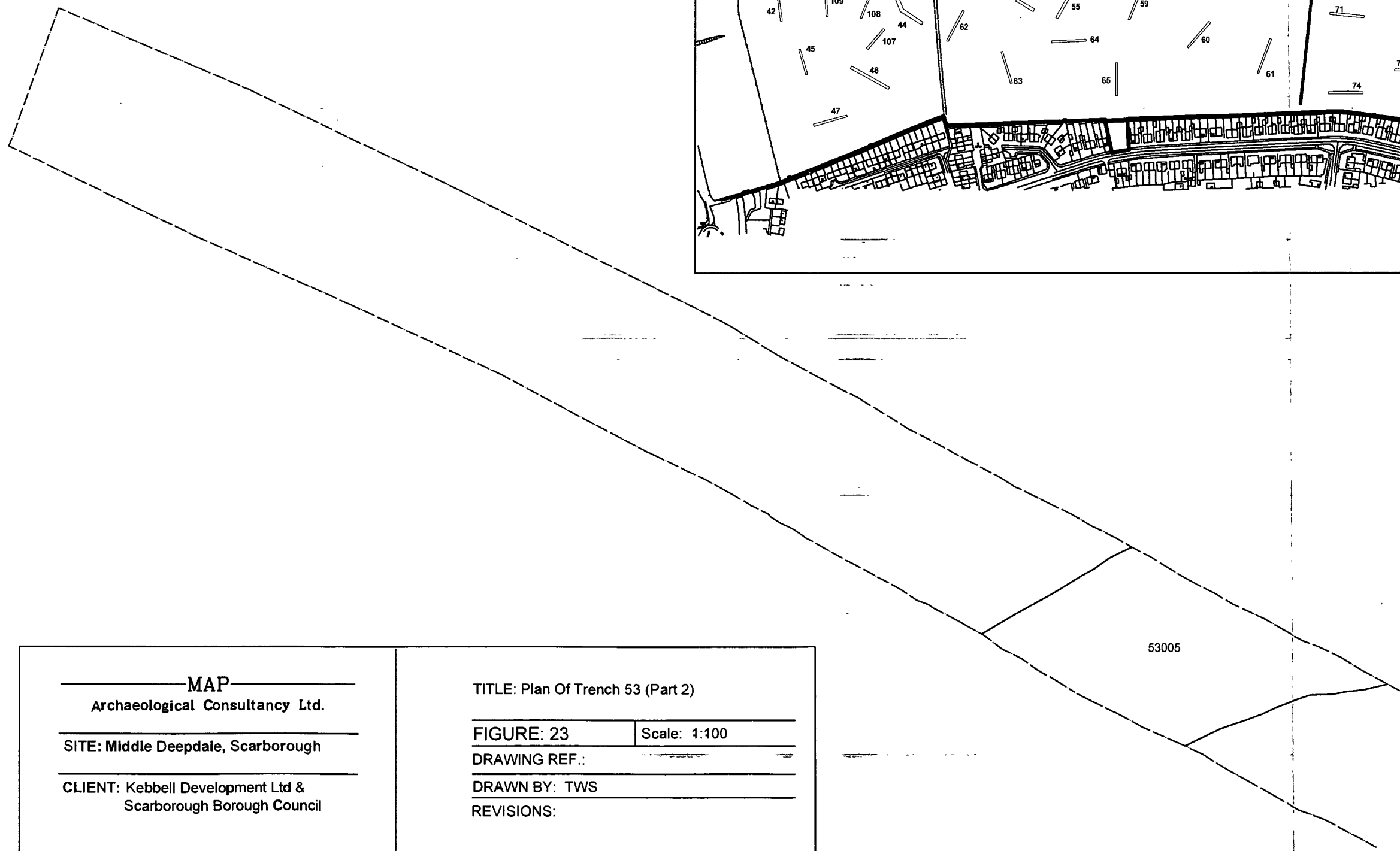
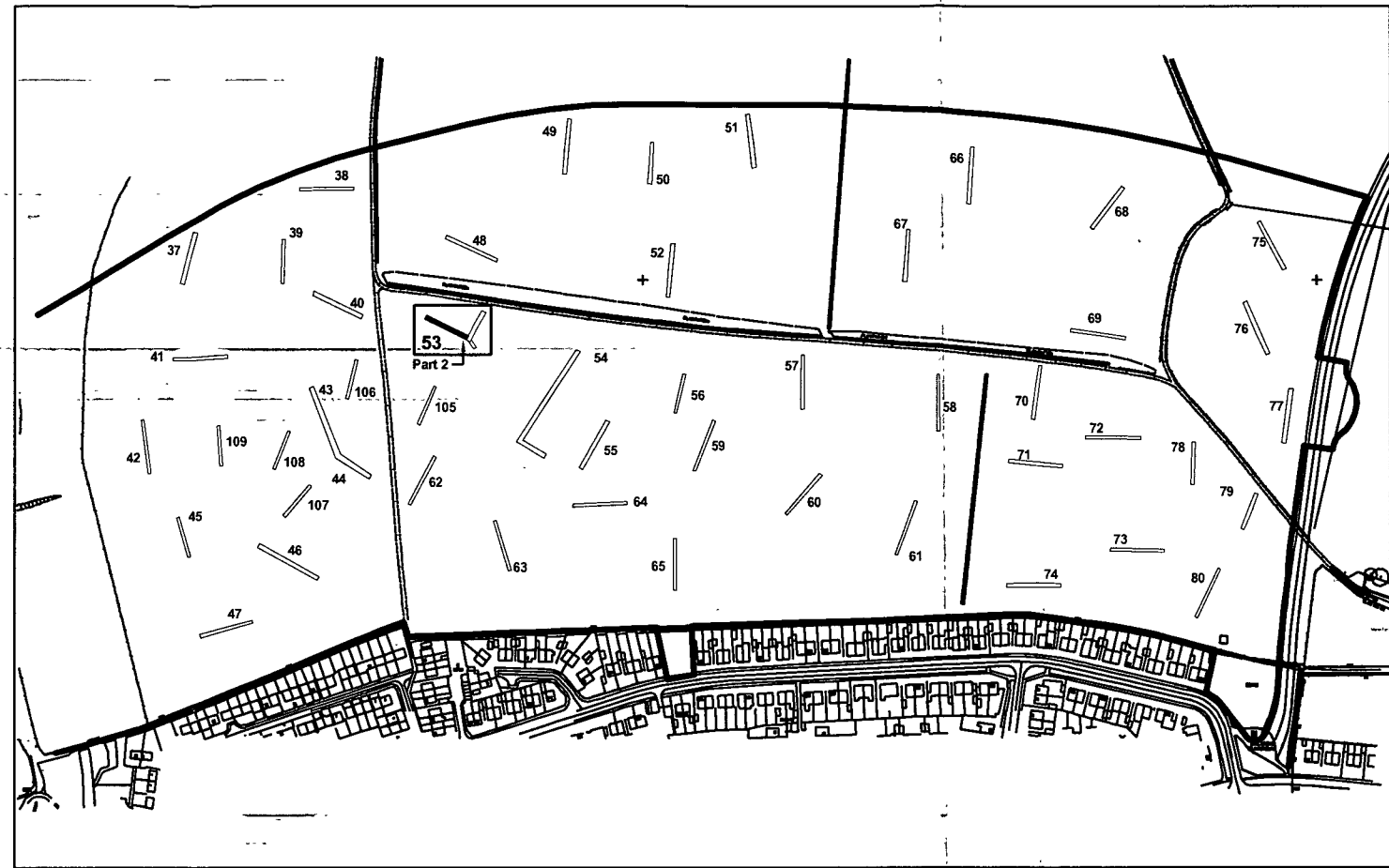

MAP Archaeological Consultancy Ltd.	
SITE: Middle Deepdale, Scarborough	
CLIENT: Kebbell Development Ltd & Scarborough Borough Council	
TITLE: Plan Of Trench 53 (Part 2)	
FIGURE: 23	Scale: 1:100
DRAWING REF.:	
DRAWN BY: TWS	
REVISIONS:	

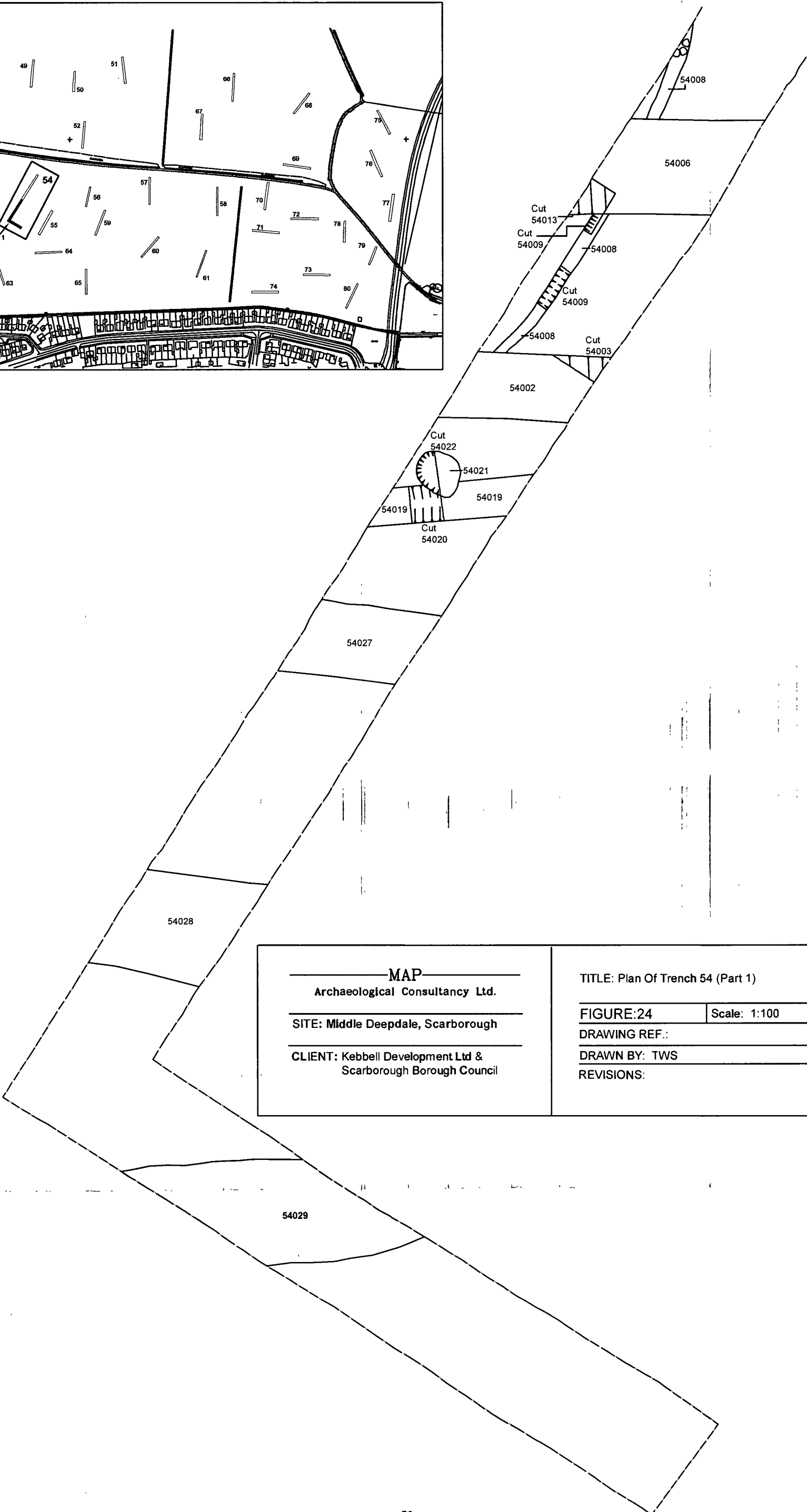
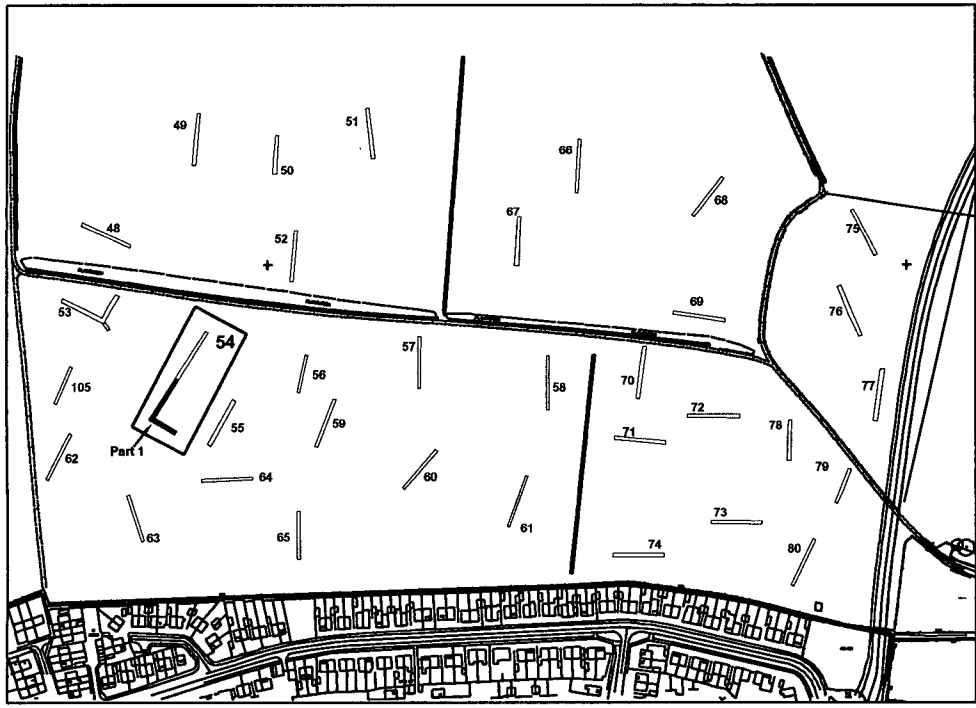

MAP Archaeological Consultancy Ltd.	
SITE: Middle Deepdale, Scarborough	
CLIENT: Kebbelle Development Ltd & Scarborough Borough Council	
TITLE: Plan Of Trench 54 (Part 1)	Scale: 1:100
FIGURE: 24	DRAWING REF.:
DRAWN BY: TWS	REVISIONS:

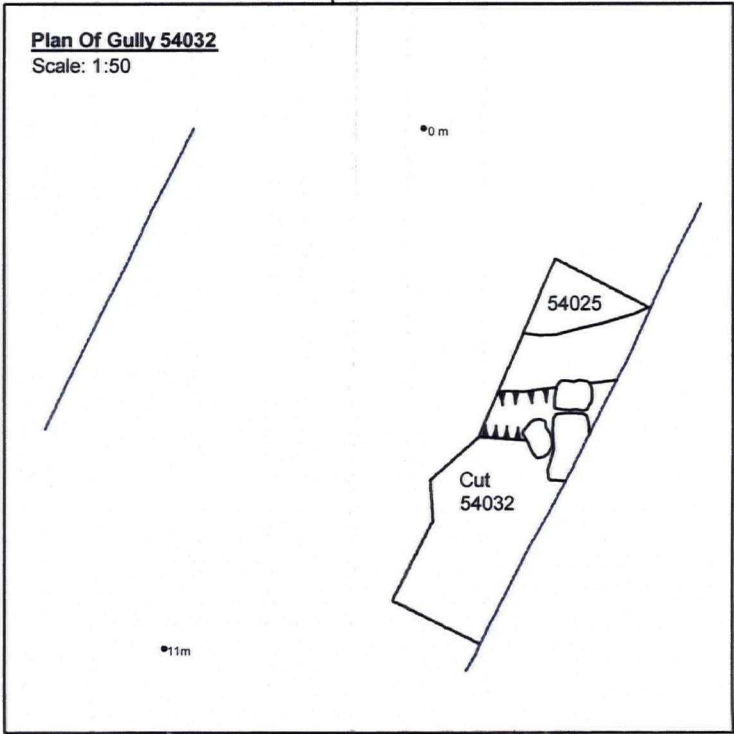
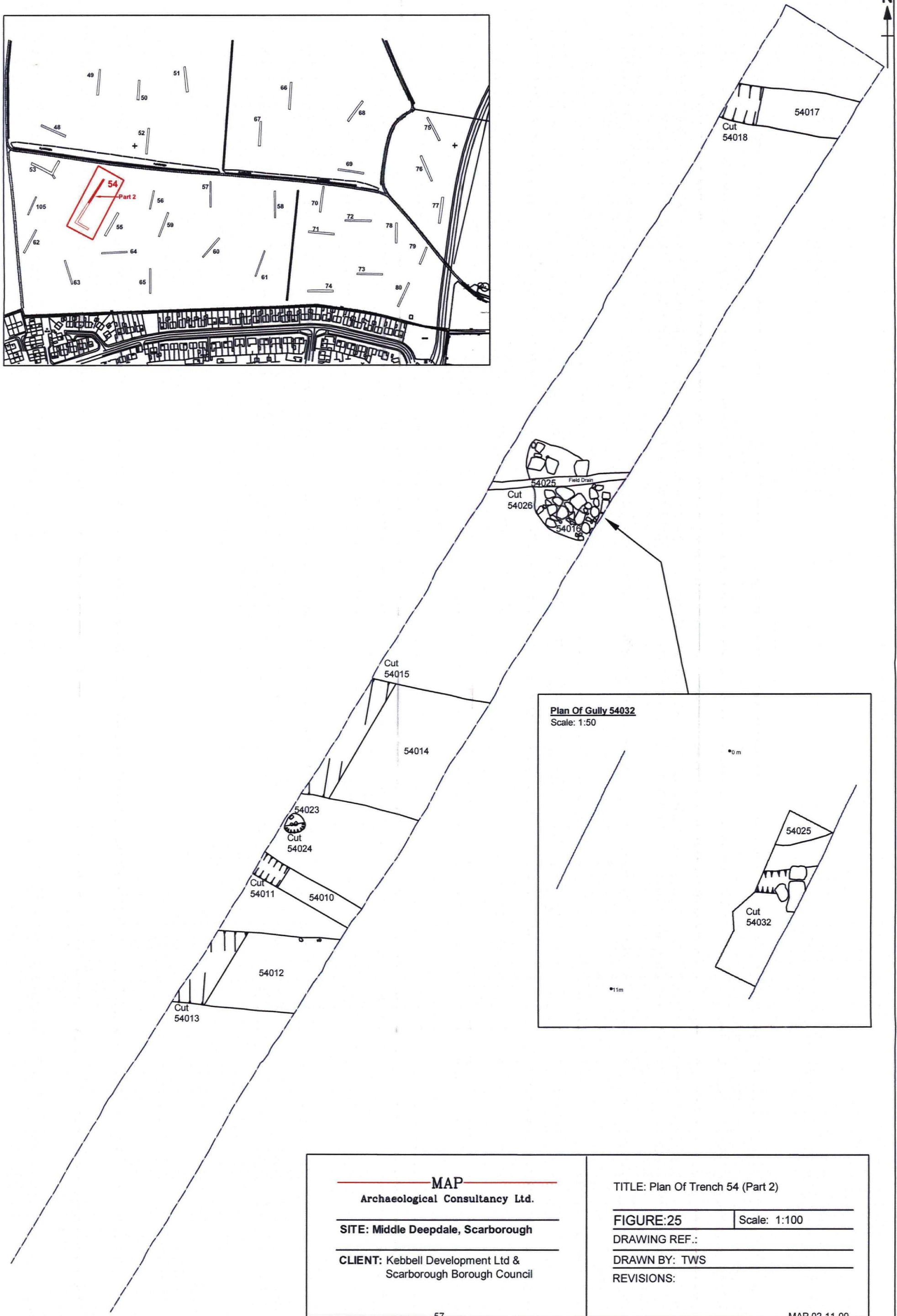
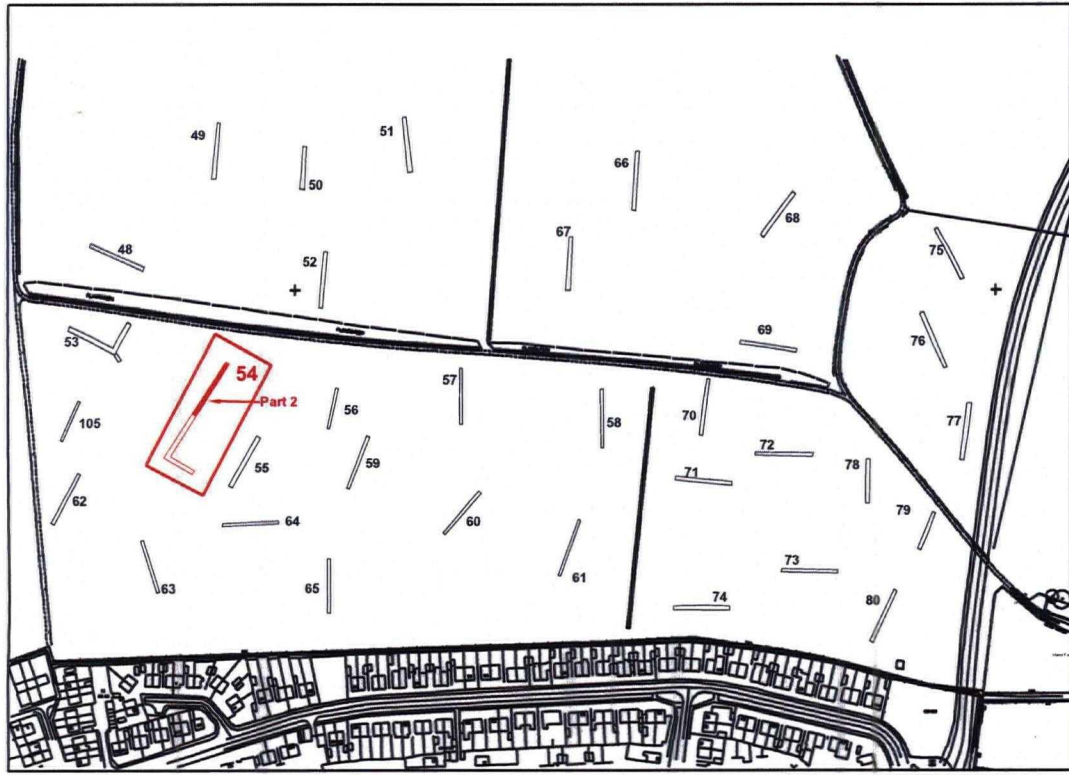

MAP Archaeological Consultancy Ltd.		TITLE: Plan Of Trench 54 (Part 2)	
SITE: Middle Deepdale, Scarborough		FIGURE:25	Scale: 1:100
CLIENT: Kebbell Development Ltd & Scarborough Borough Council		DRAWING REF.:	
		DRAWN BY: TWS	
		REVISIONS:	

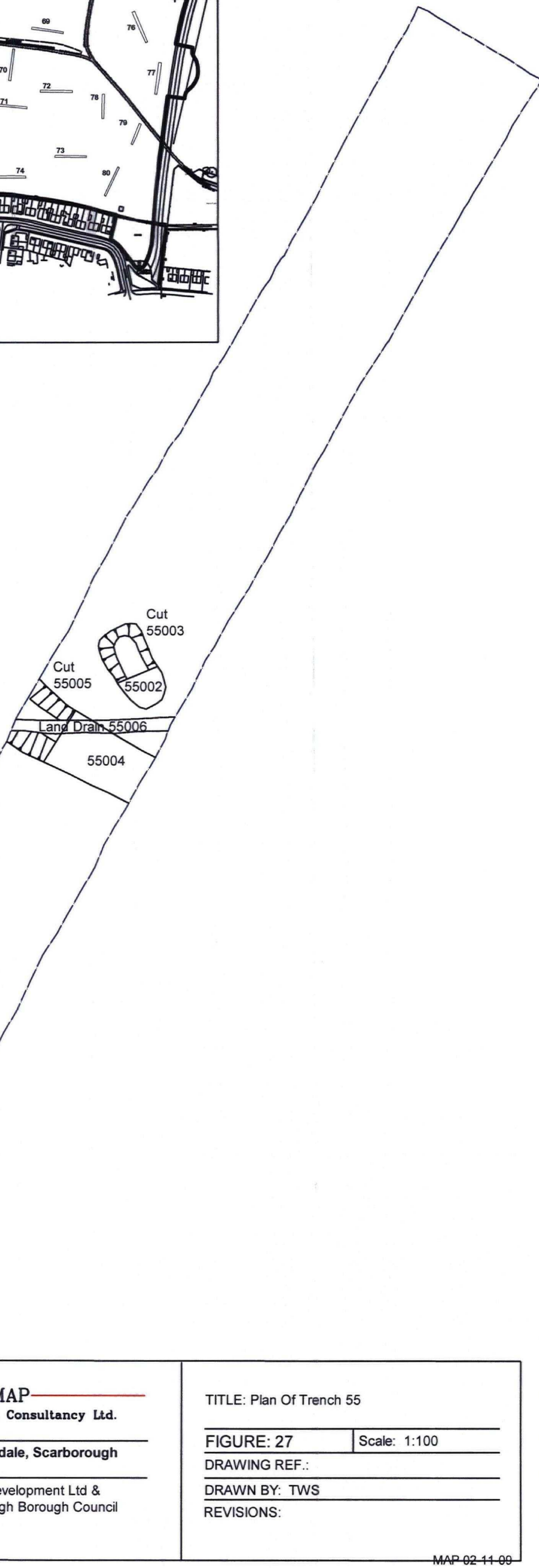
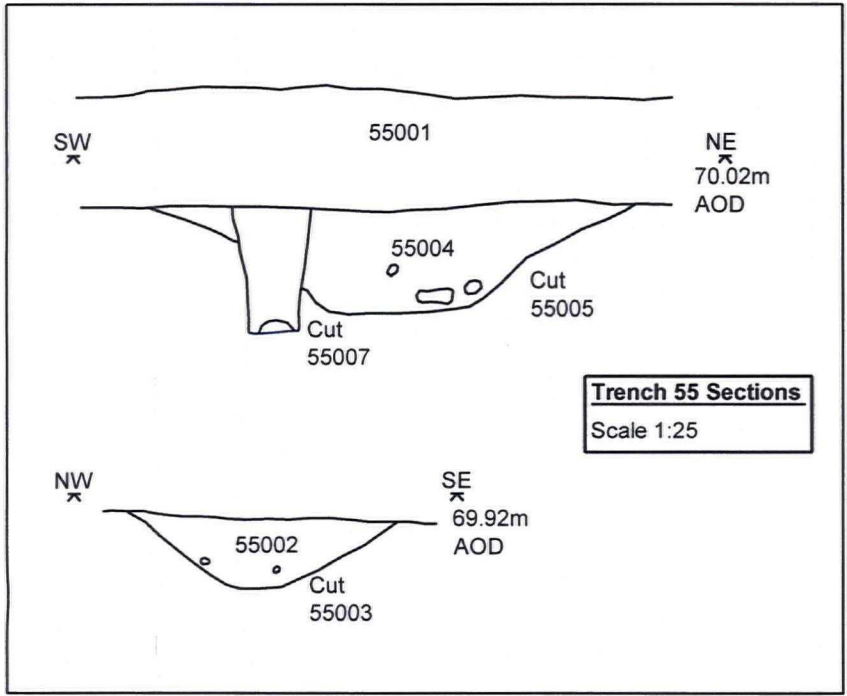
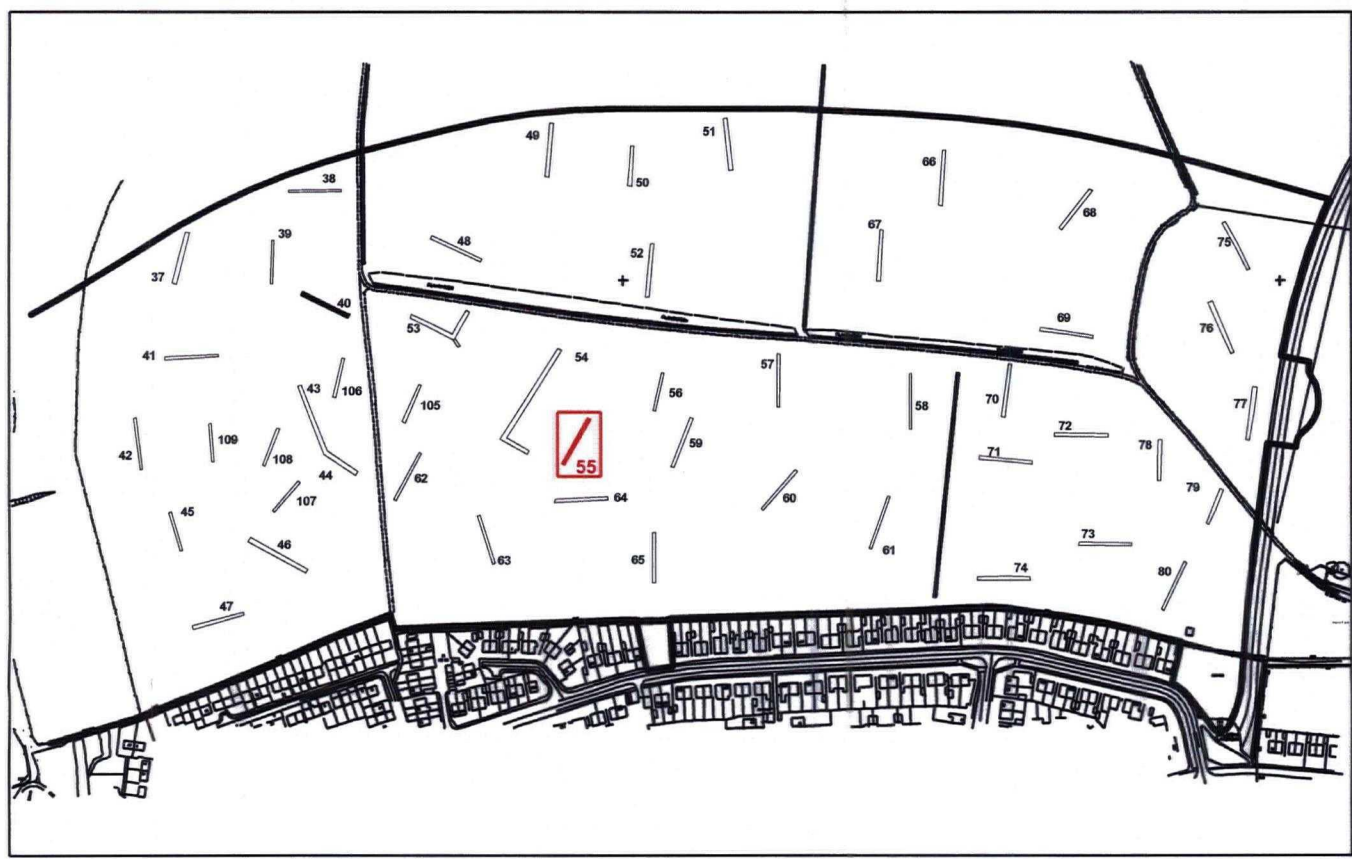

MAP Archaeological Consultancy Ltd.		TITLE: Plan Of Trench 55	
SITE: Middle Deepdale, Scarborough		FIGURE: 27	Scale: 1:100
CLIENT: Kebbell Development Ltd & Scarborough Borough Council		DRAWING REF.:	
		DRAWN BY: TWS	
		REVISIONS:	

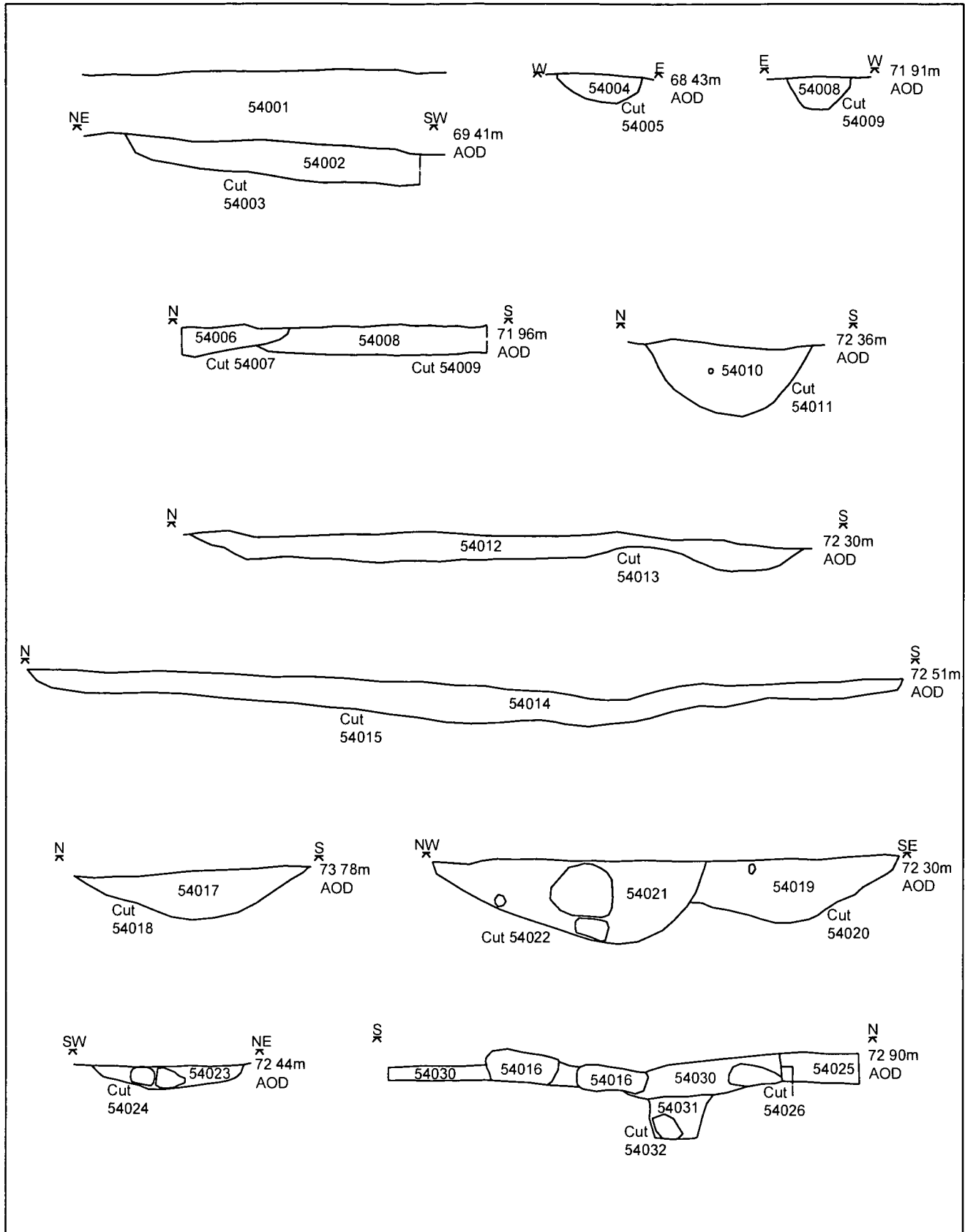

MAP
 Archaeological Consultancy Ltd

 SITE Middle Deepdale, Scarborough

 CLIENT Kebell Development Ltd &
 Scarborough Borough Council

TITLE Trench 54 Sections

 FIGURE 26 | Scale 1:25

 DRAWING REF

 DRAWN BY TWS

 REVISIONS

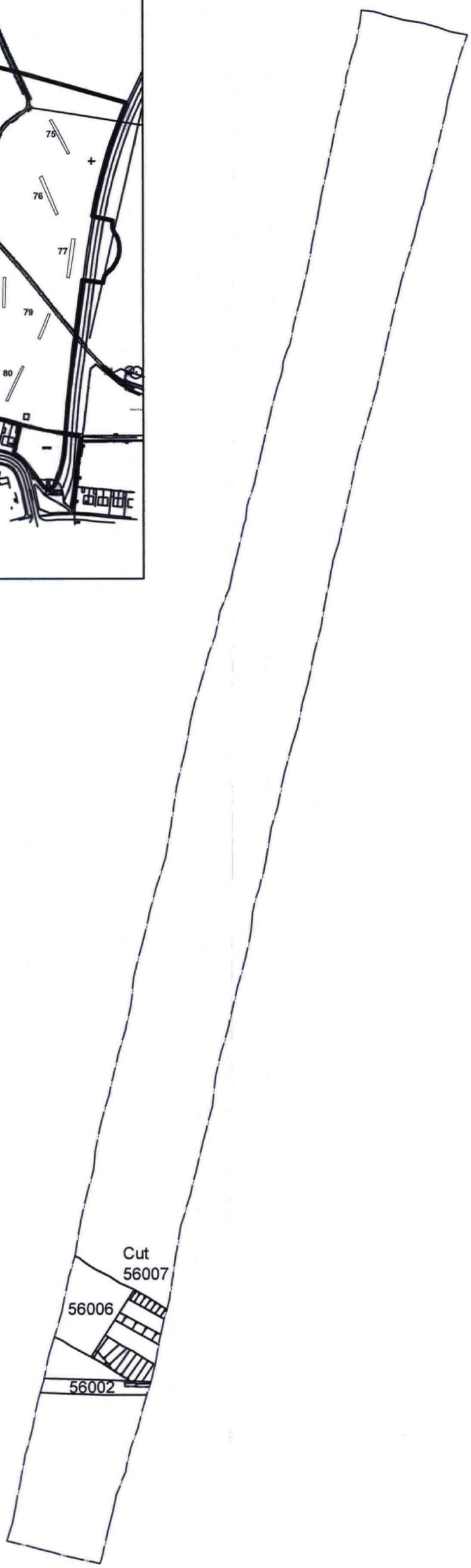
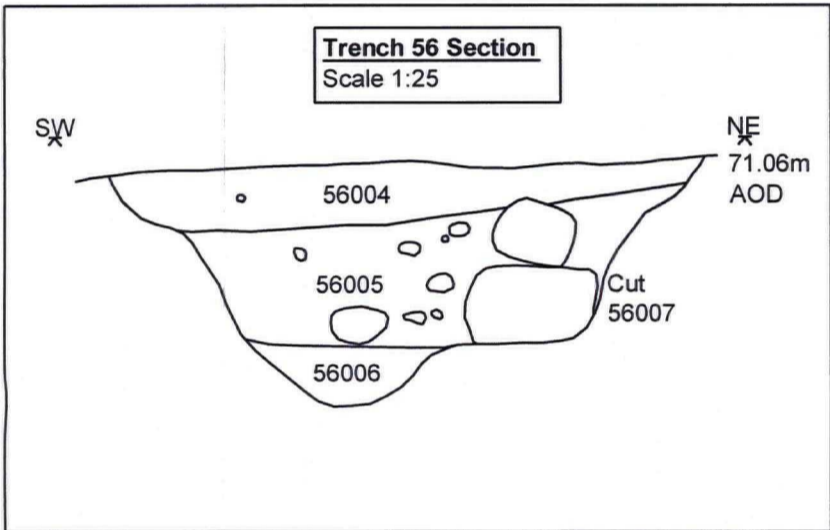
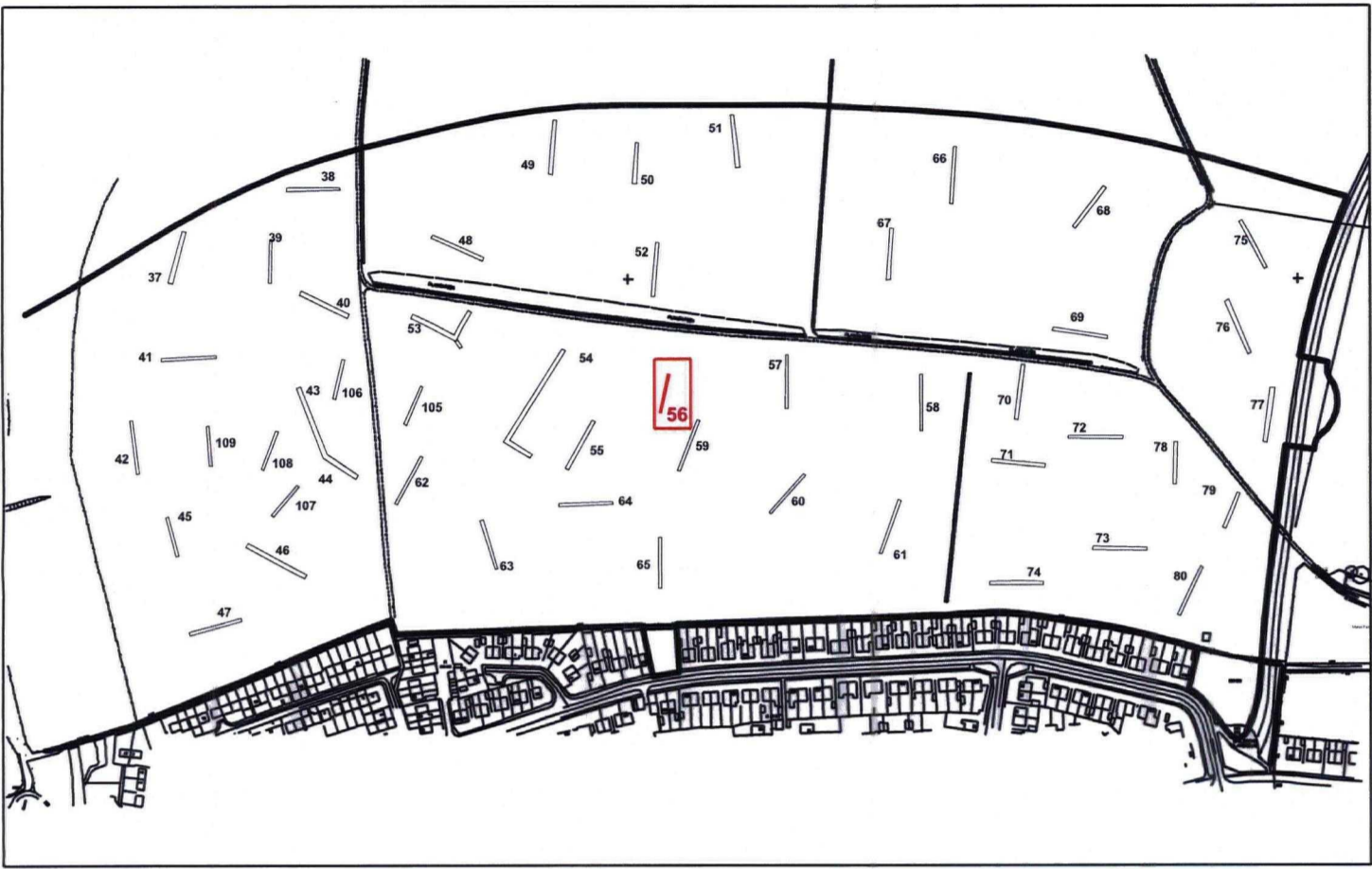

<p>MAP Archaeological Consultancy Ltd.</p> <p>SITE: Middle Deepdale, Scarborough</p> <p>CLIENT: Kebbell Development Ltd & Scarborough Borough Council</p>	<p>TITLE: Plan Of Trench 56</p>	
	<p>FIGURE: 28</p>	<p>Scale: 1:100</p>
	<p>DRAWING REF.:</p>	
	<p>DRAWN BY: TWS</p> <p>REVISIONS:</p>	

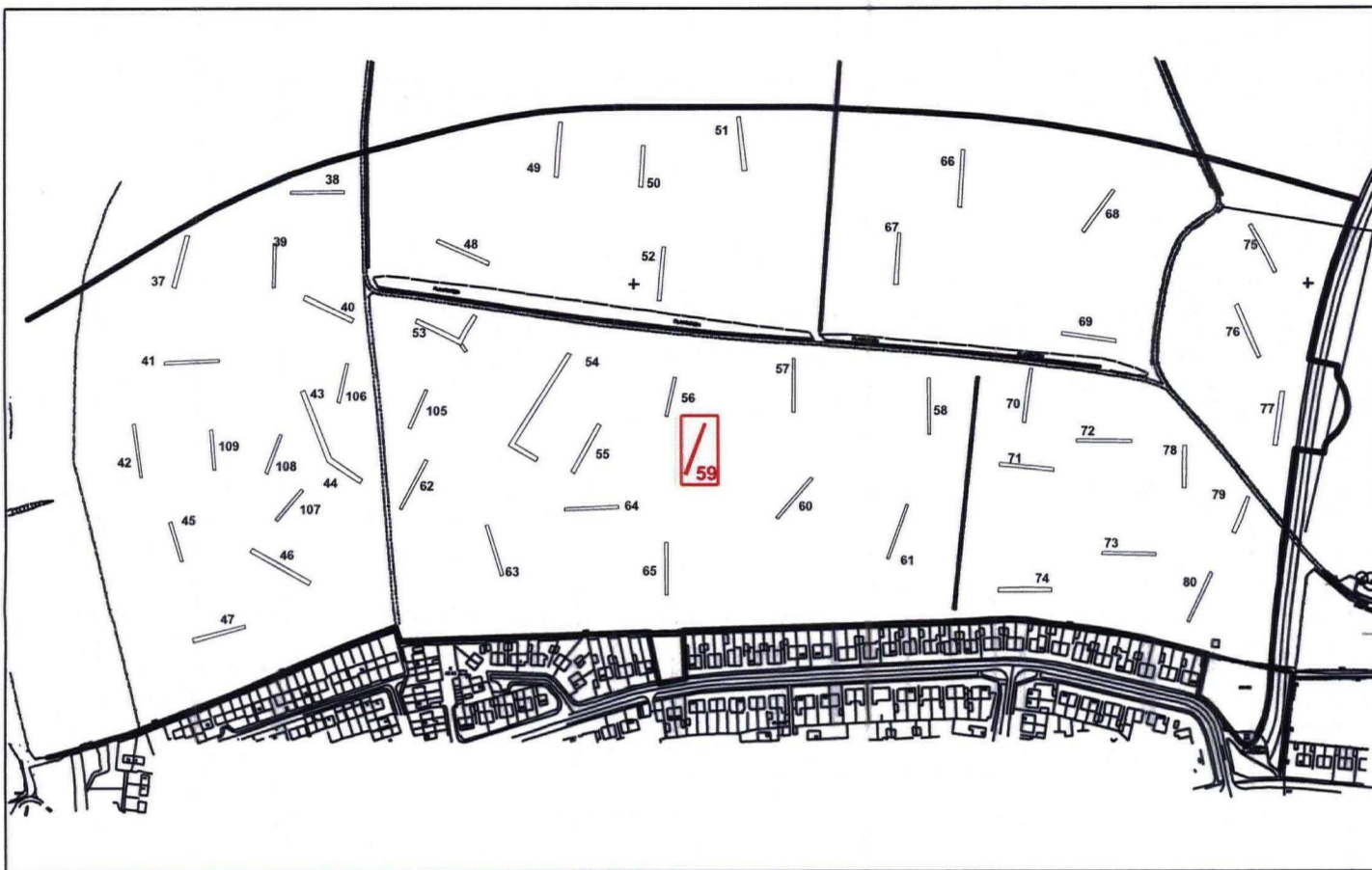

Trench 59 Sections
Scale 1:25

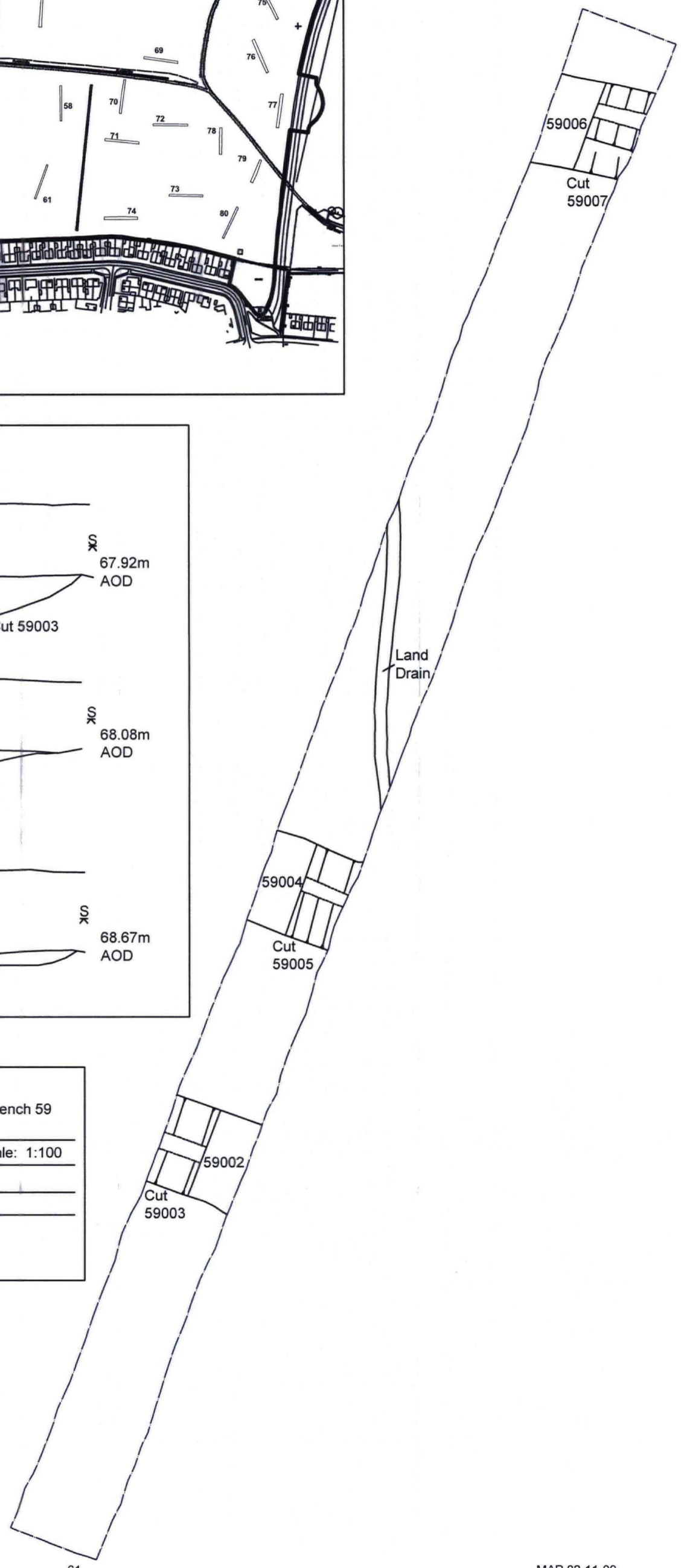
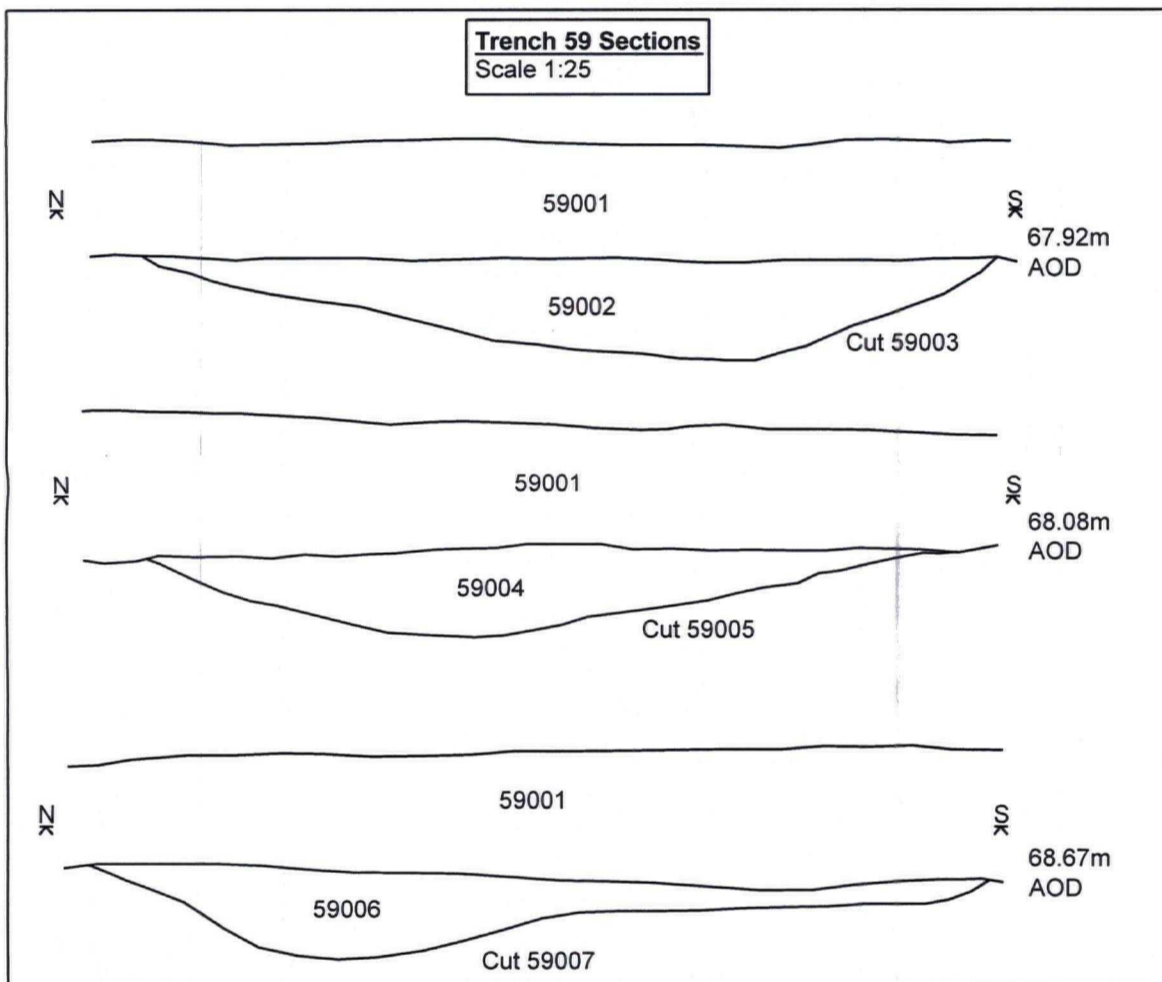

MAP Archaeological Consultancy Ltd.		TITLE: Plan & Sections Of Trench 59	
SITE: Middle Deepdale, Scarborough		FIGURE: 29	Scale: 1:100
CLIENT: Kebbelle Development Ltd & Scarborough Borough Council		DRAWING REF.:	
		DRAWN BY: TWS	
		REVISIONS:	

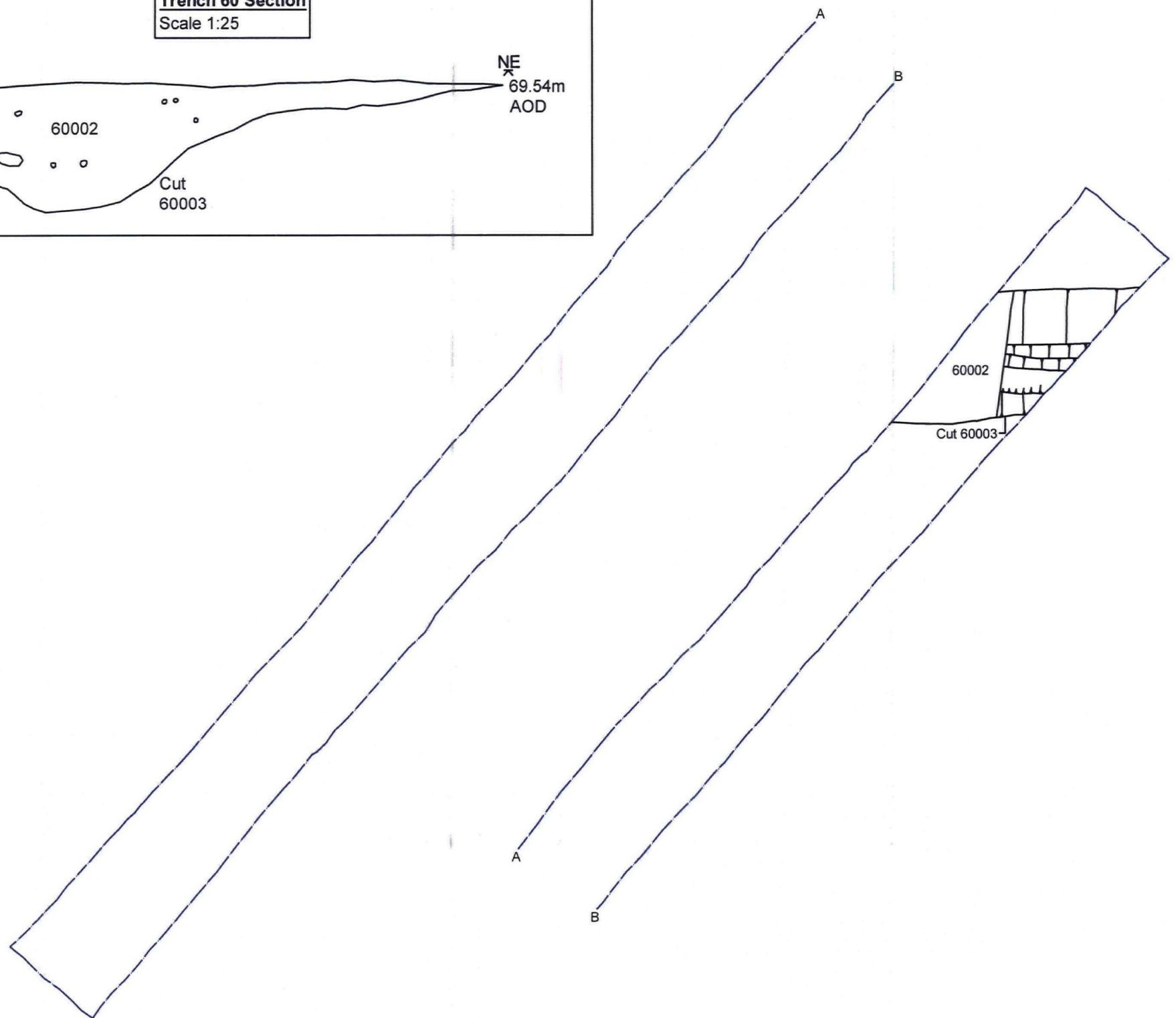
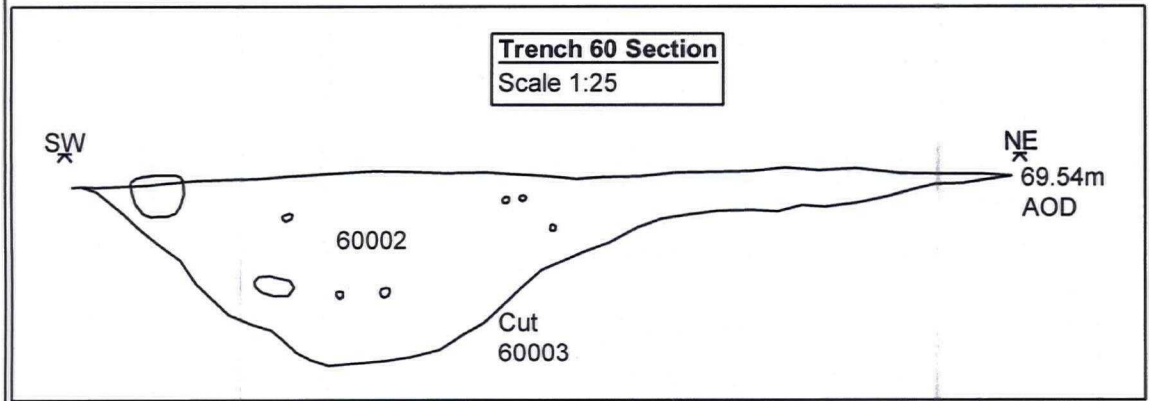
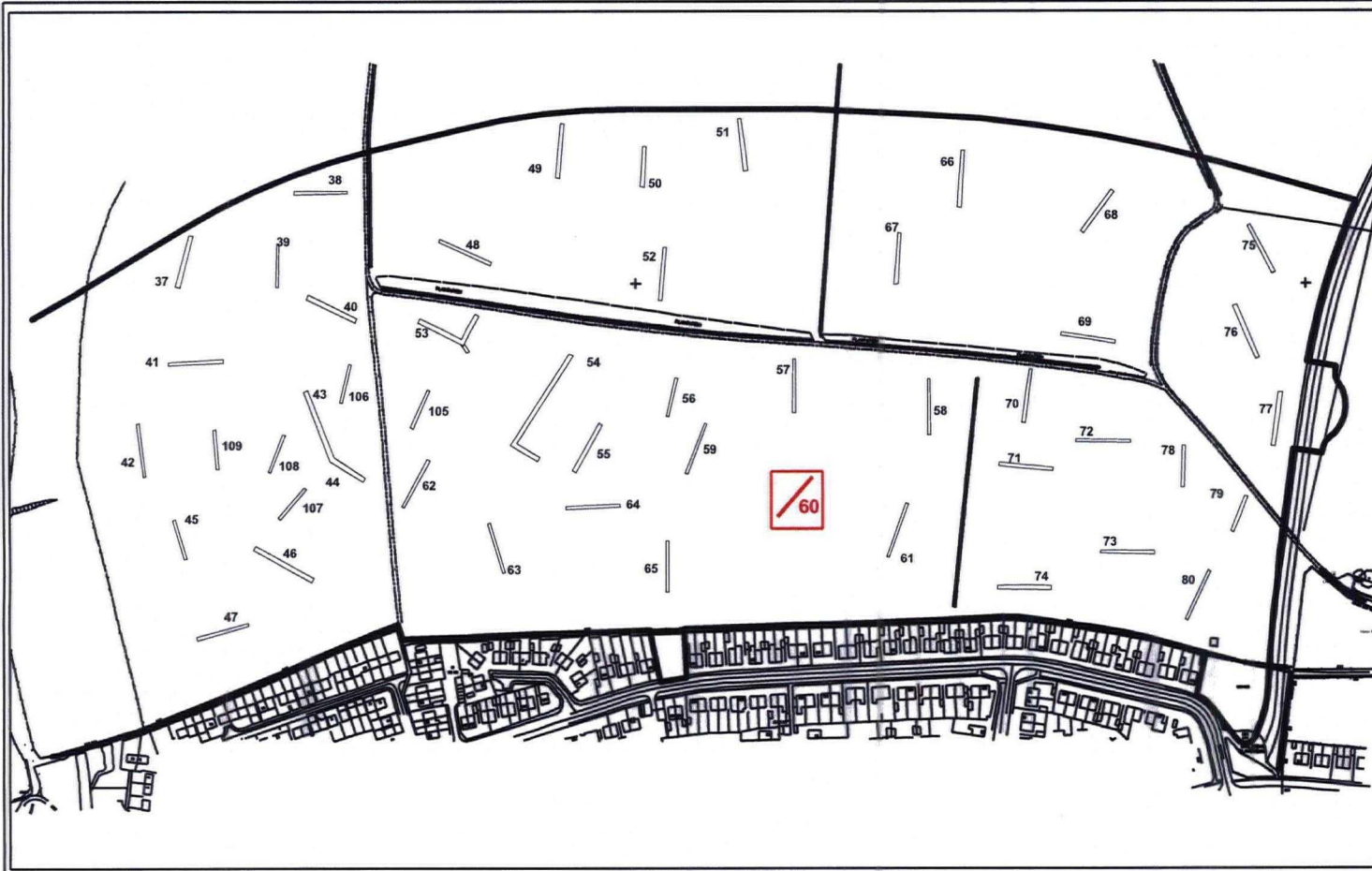

<p>MAP Archaeological Consultancy Ltd.</p> <p>SITE: Middle Deepdale, Scarborough</p> <p>CLIENT: Kebbelle Development Ltd & Scarborough Borough Council</p>	TITLE: Plan Of Trench 60	
	FIGURE: 30	Scale: 1:100
	DRAWING REF.:	
	DRAWN BY: TWS	
REVISIONS:		