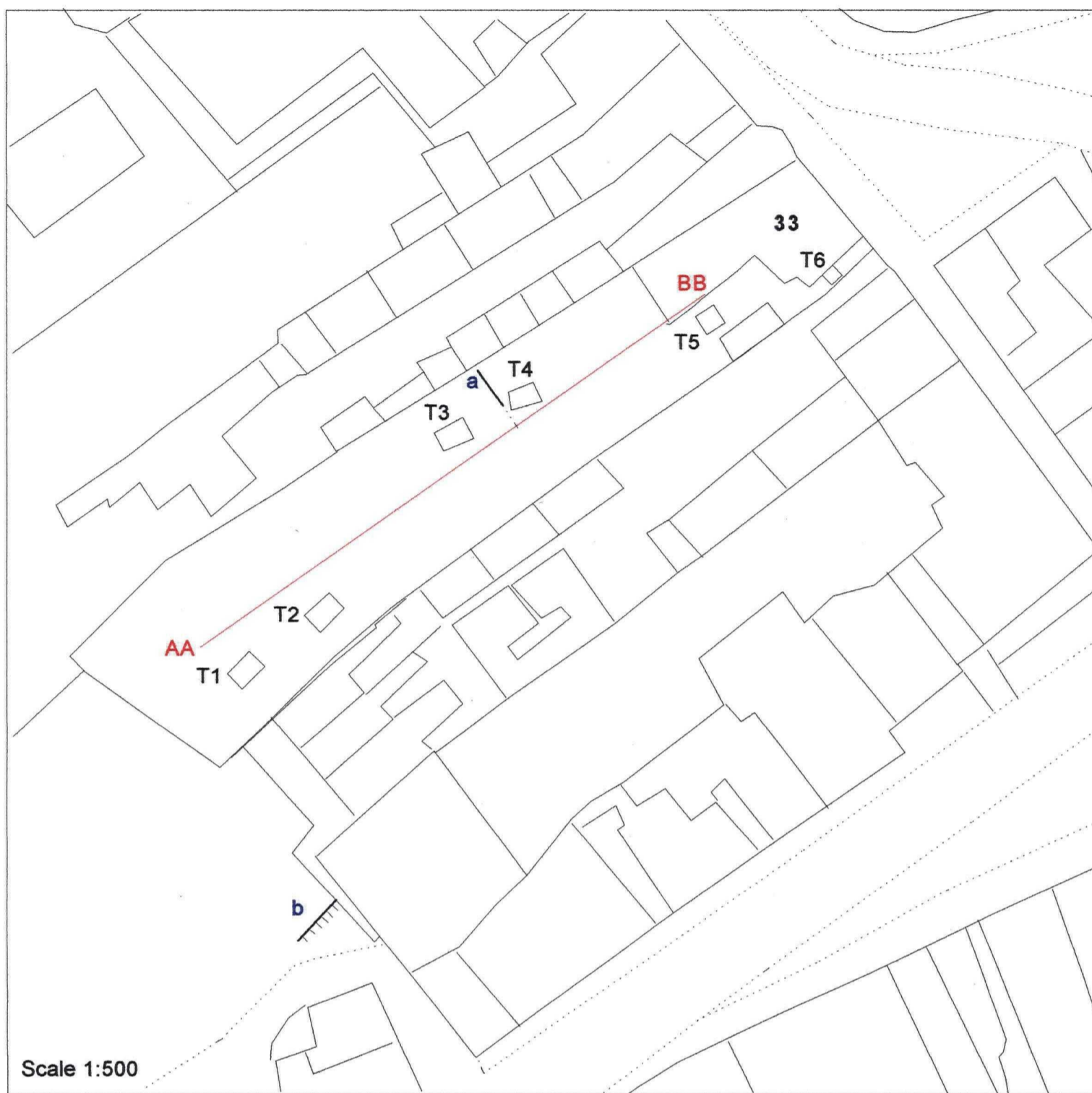
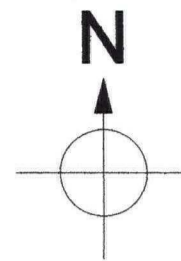

Figure 1. Site Location.



Scale 1:500

SE 48429 82000

- a - Retaining Wall
- b - Bank
- - Line of Schematic Section

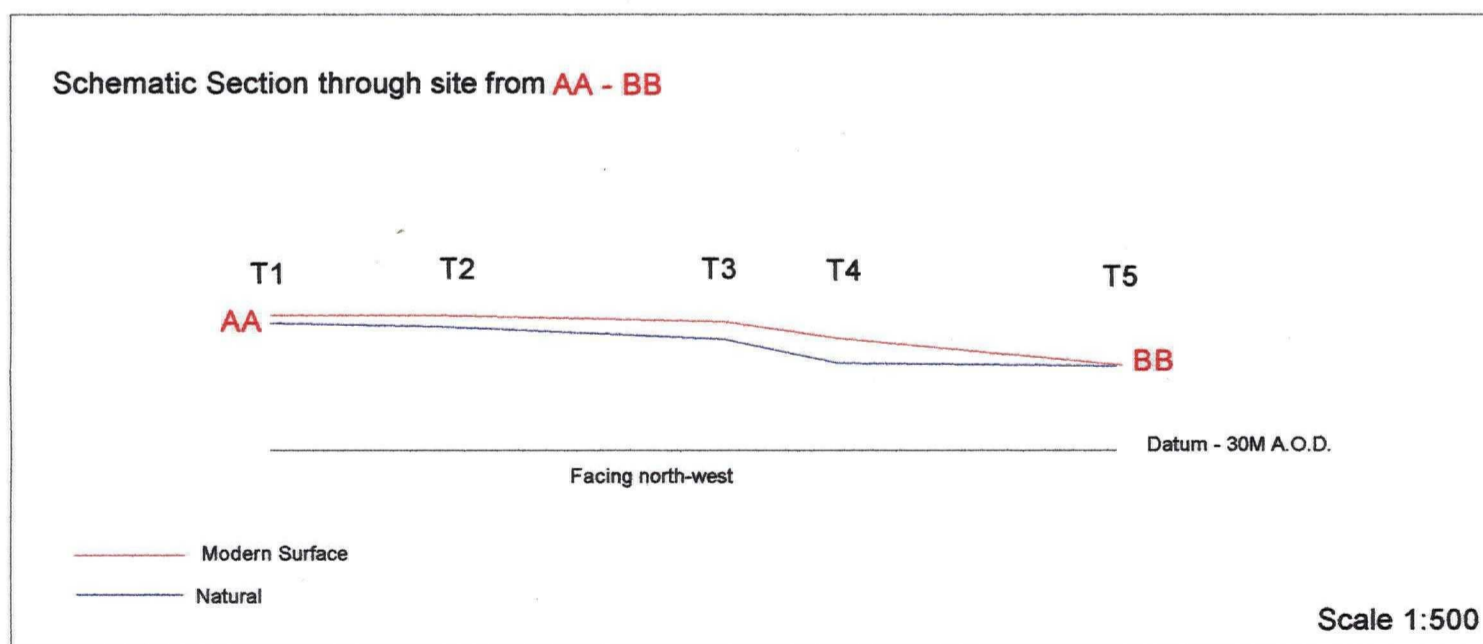

Figure 2: Trench Locations

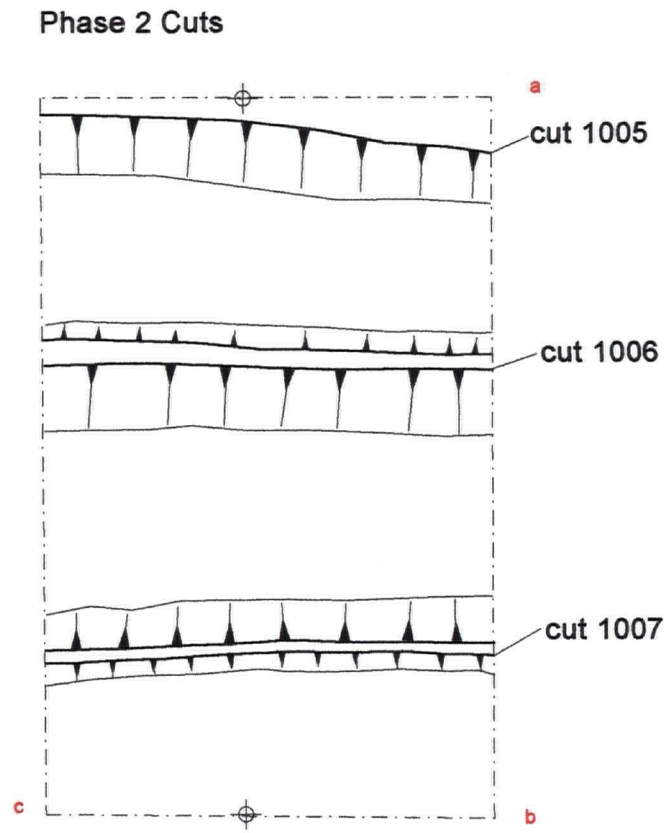
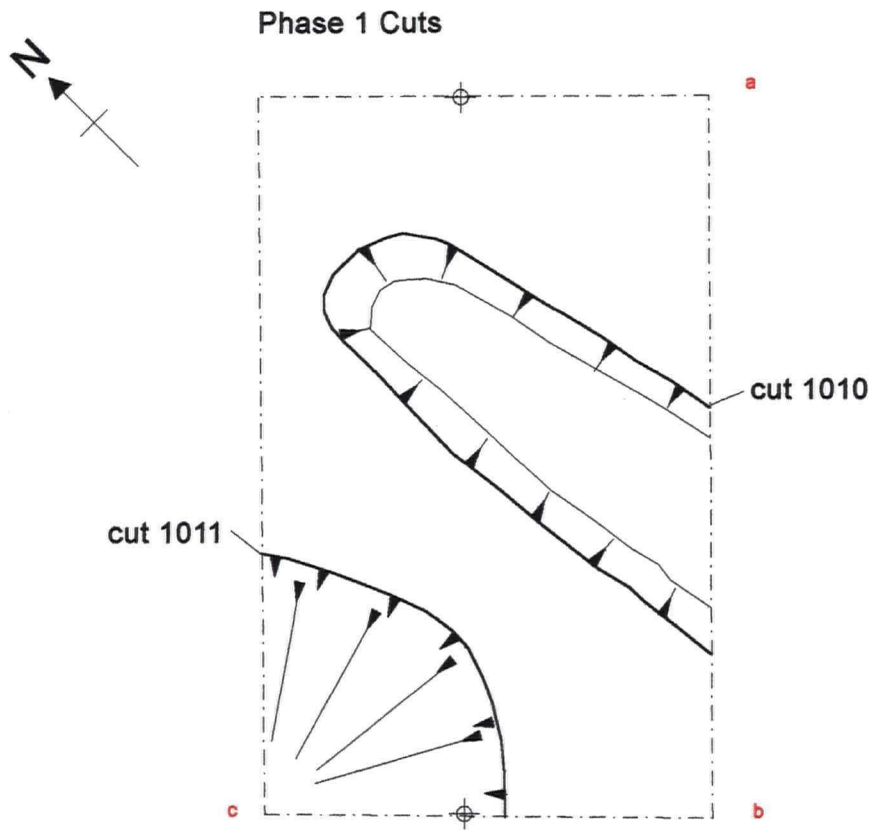
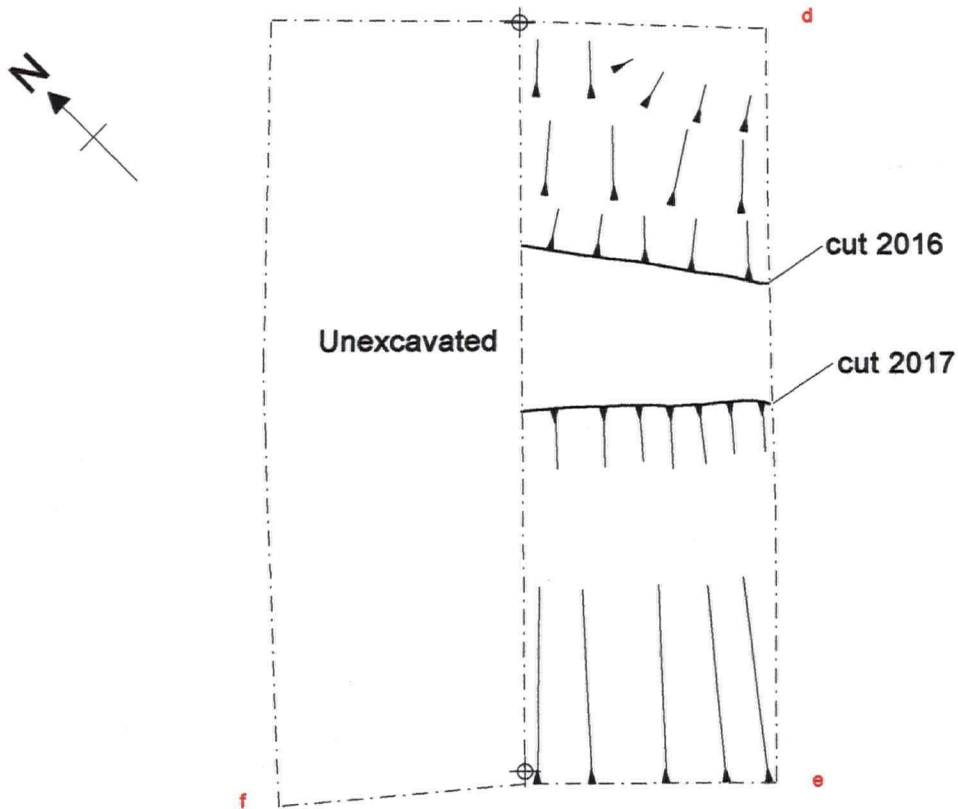

Figure 3: Trench 1 Cut Features

Trench 2 Phase 1 Cut Features



Trench 2 Phase 2 Cut Features

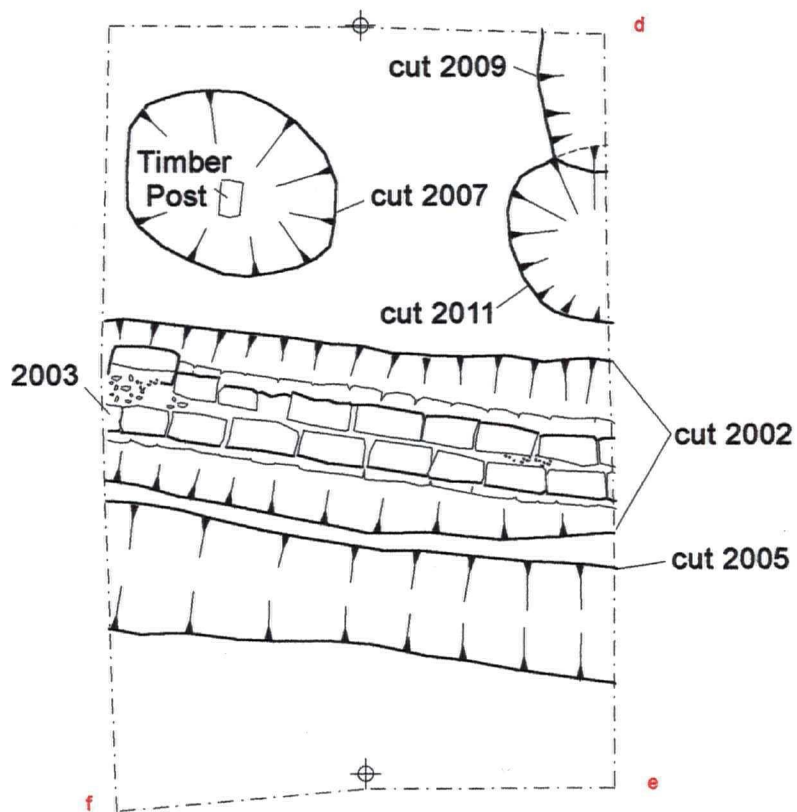
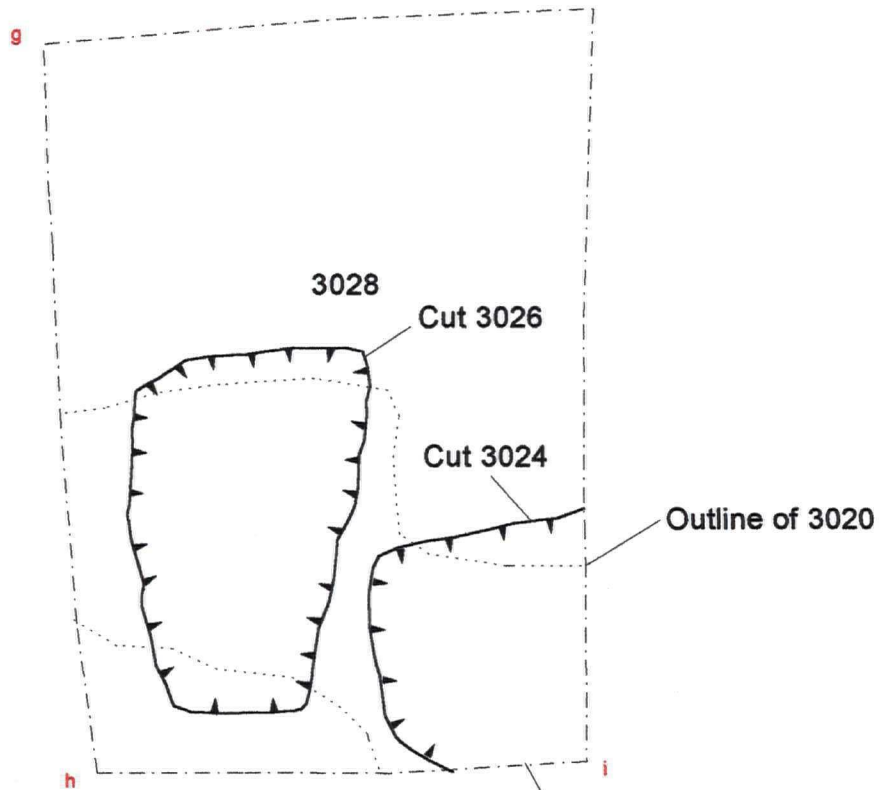
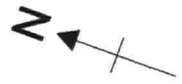

Figure 4: Trench 2 Cut Features

Phase 1 Pits



N.B. 3028 does not show in this section

Mortar Surface

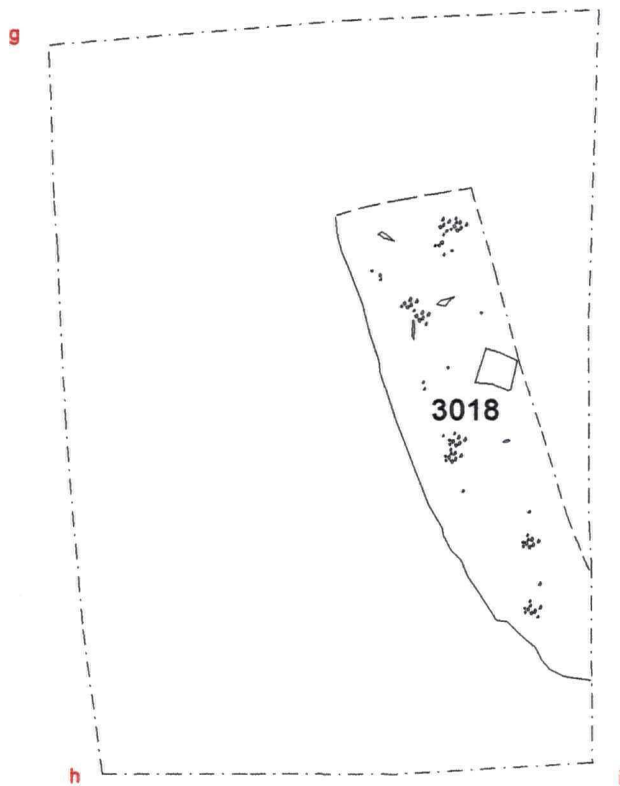

Figure 5: Trench 3 Phase Plans

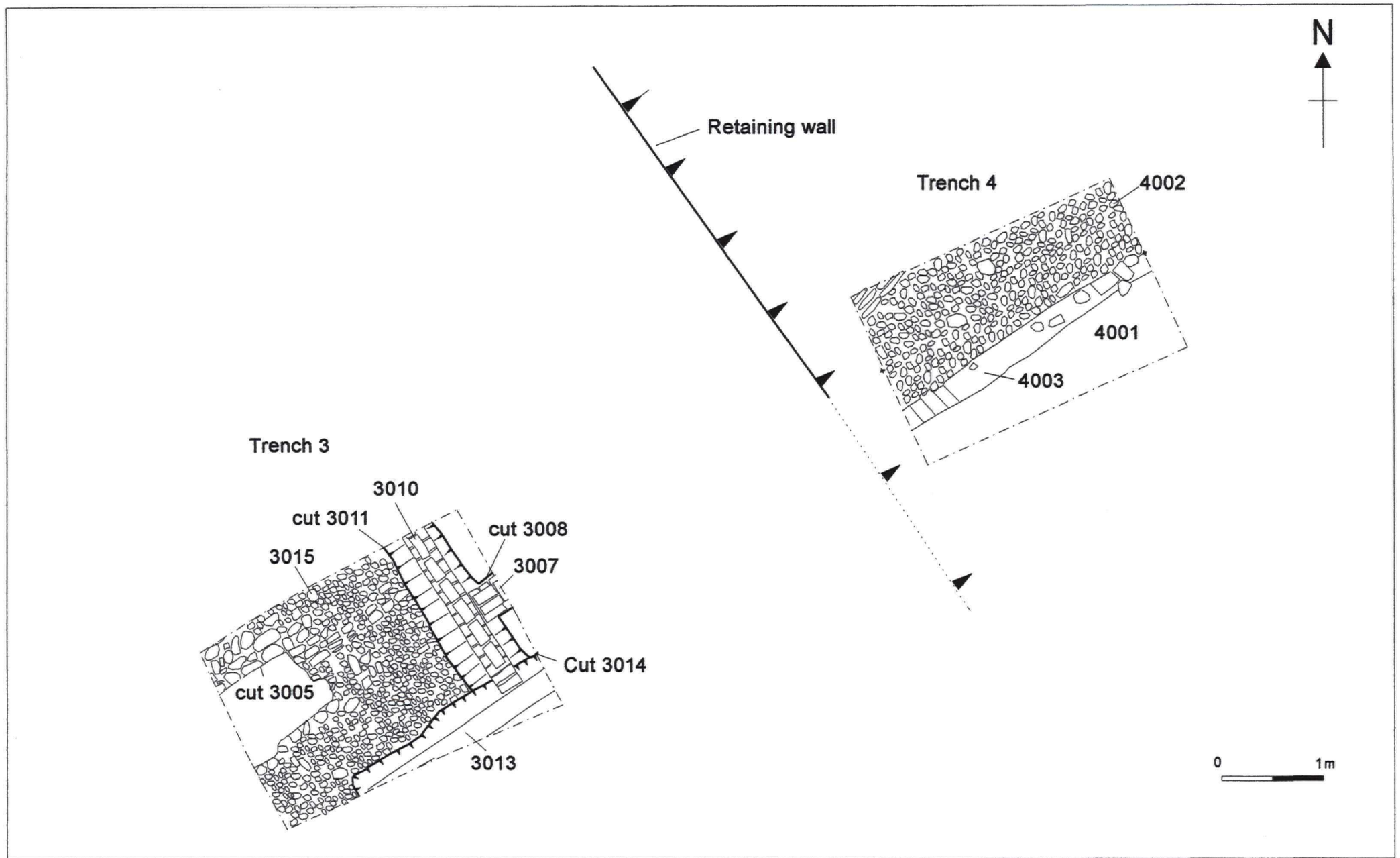
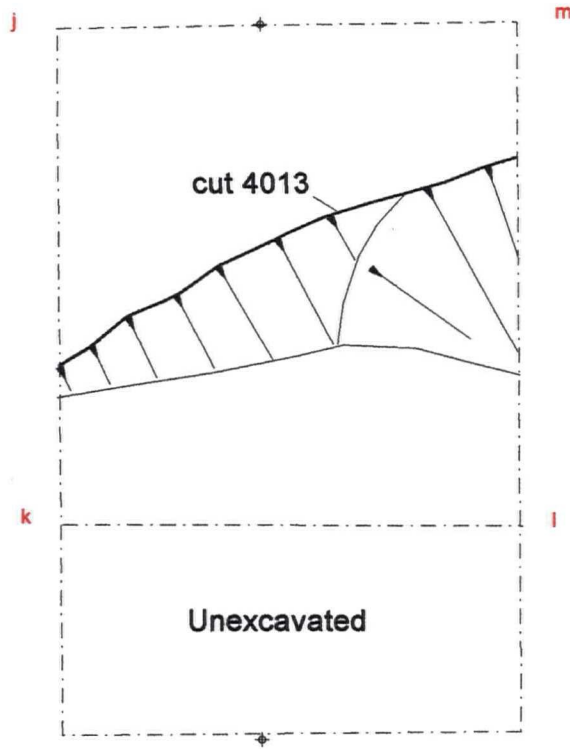
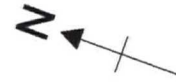

Figure 6: Post Medieval Structures in Trench 3 and 4

Pit or Ditch Cut 4013



Medieval Wall and Post Hole

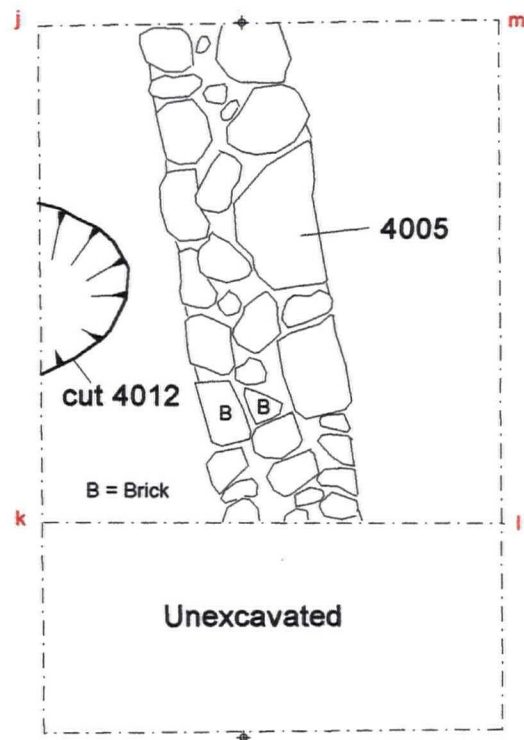
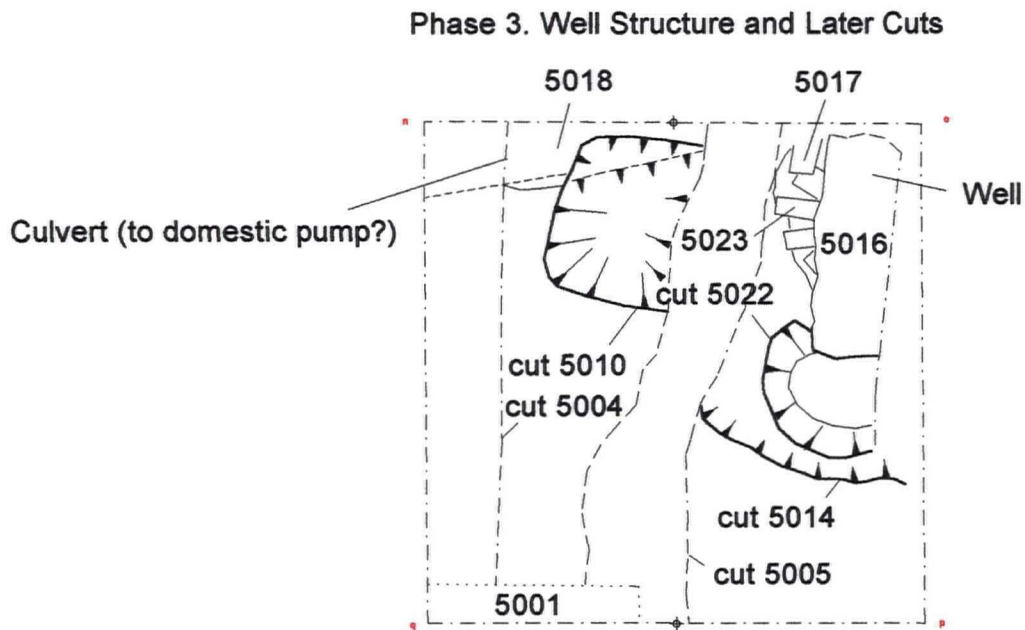
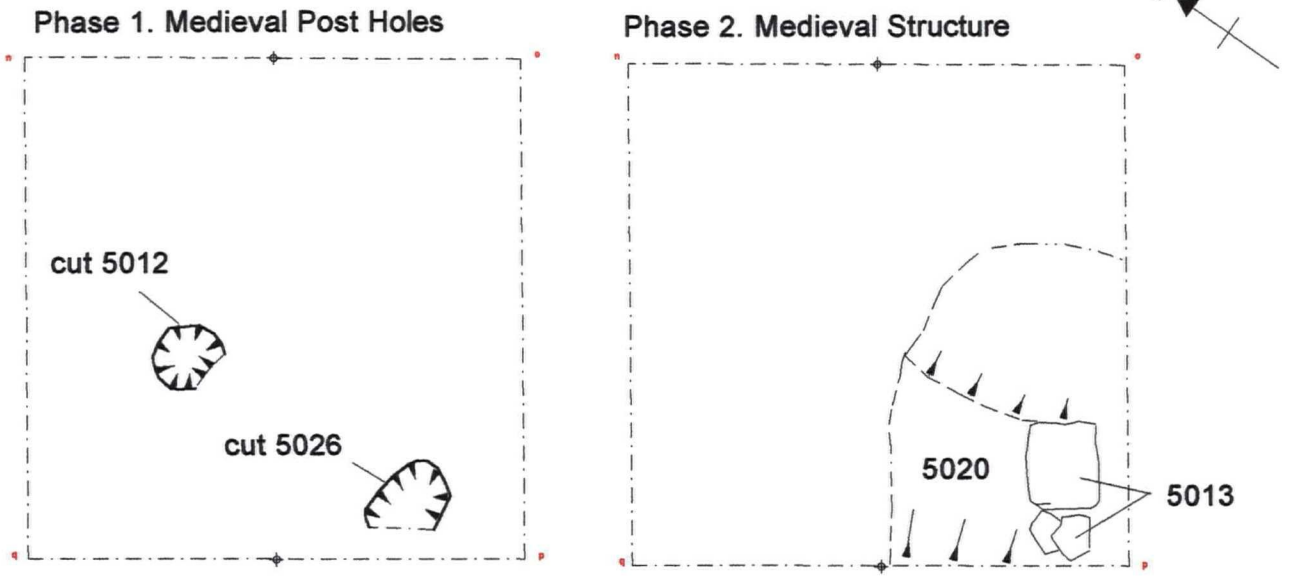

Figure 7: Trench 4 Phase Plans

Trench 5 Phase Plans



Trench 6 Excavated Features

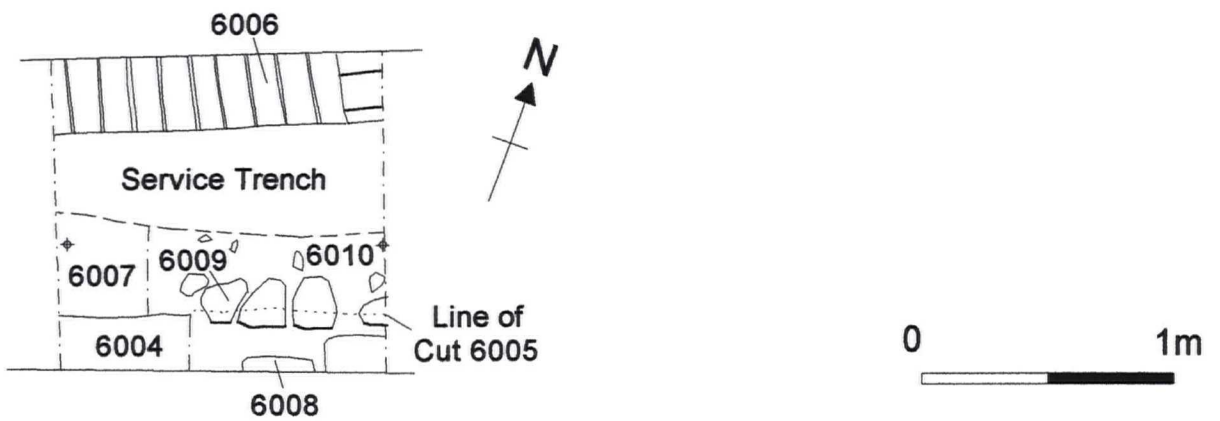
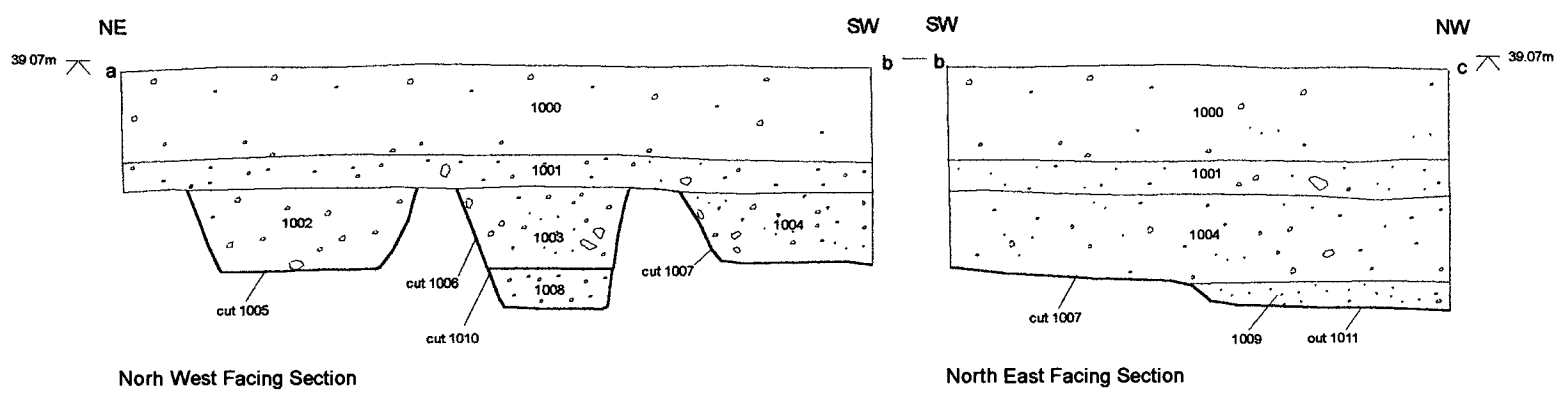
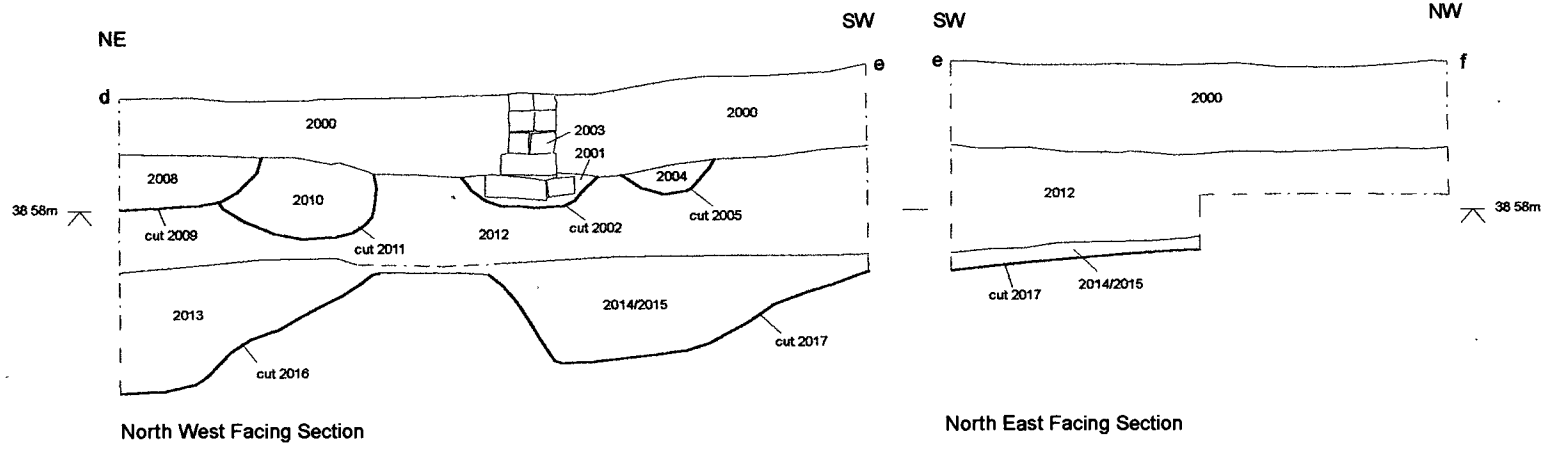

Figure 8: Trench 5 Phase Plans; Trench 6 Plan

Trench 1



Trench 2



Trench 3

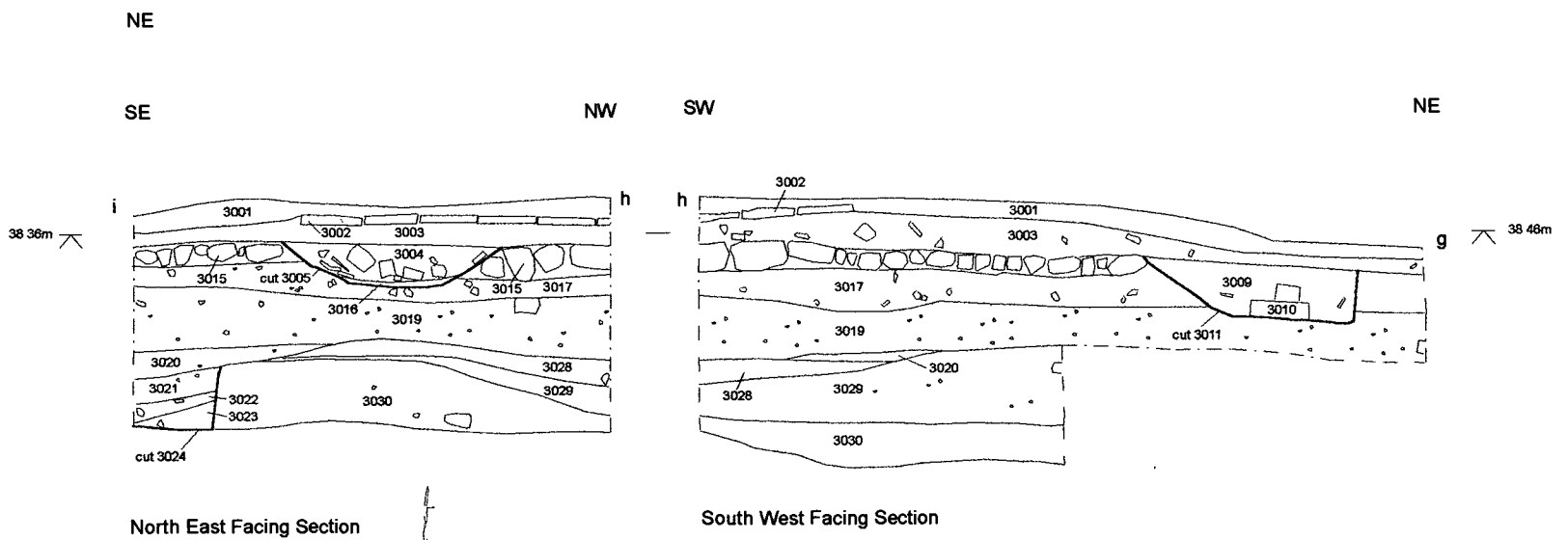

Trench 4

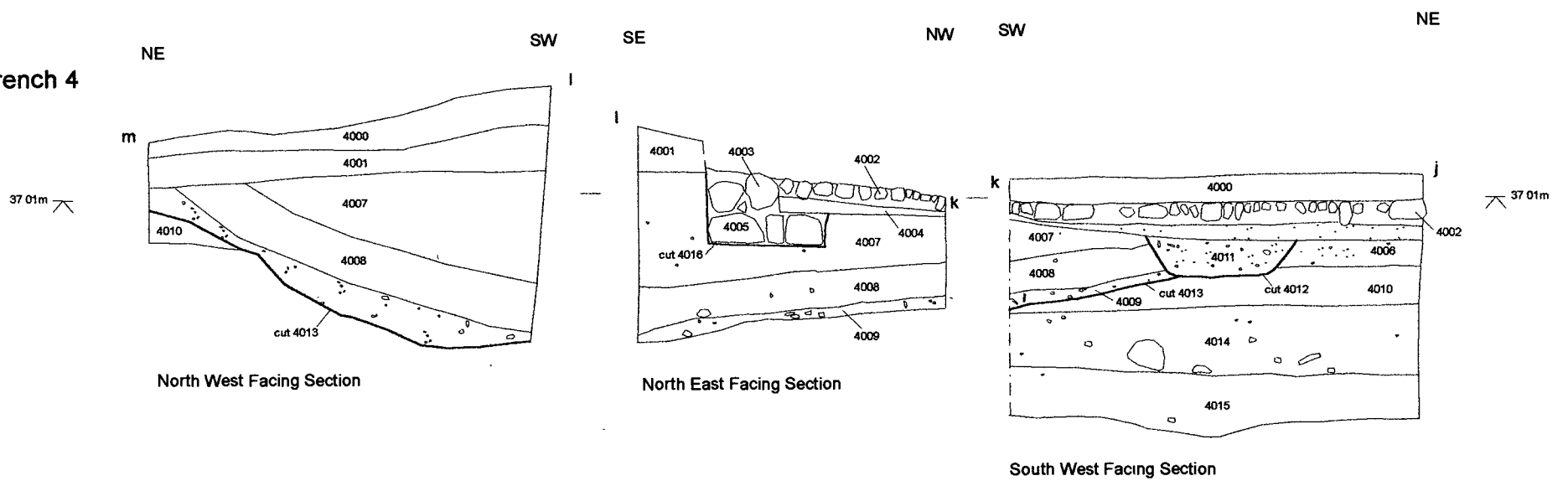

Trench 5

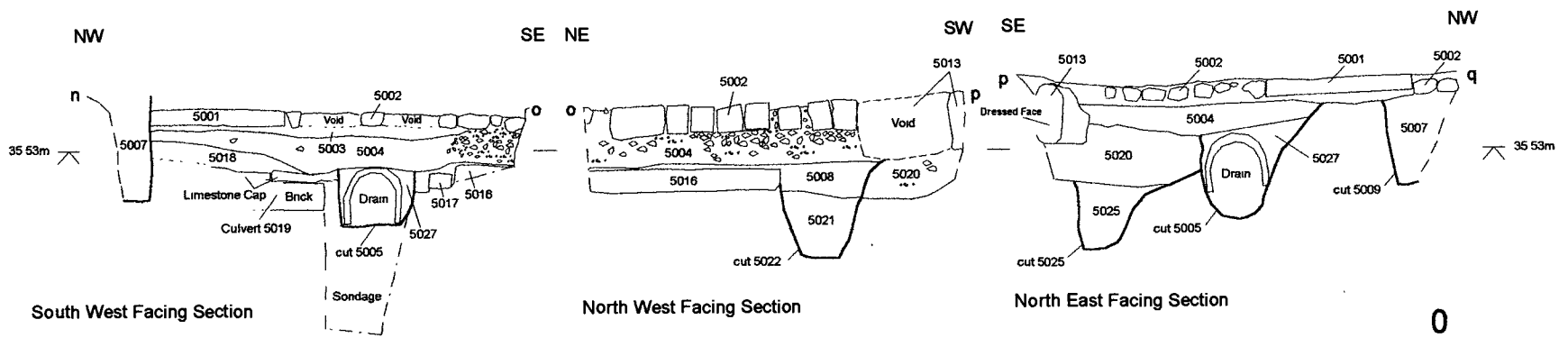

Figure 9: Trench Sections



Plate 1. Trench 1. Phase 1 Cut Features. Facing South.



Plate 2. Trench 1. Phase 2 Cut Features. Facing South-east.

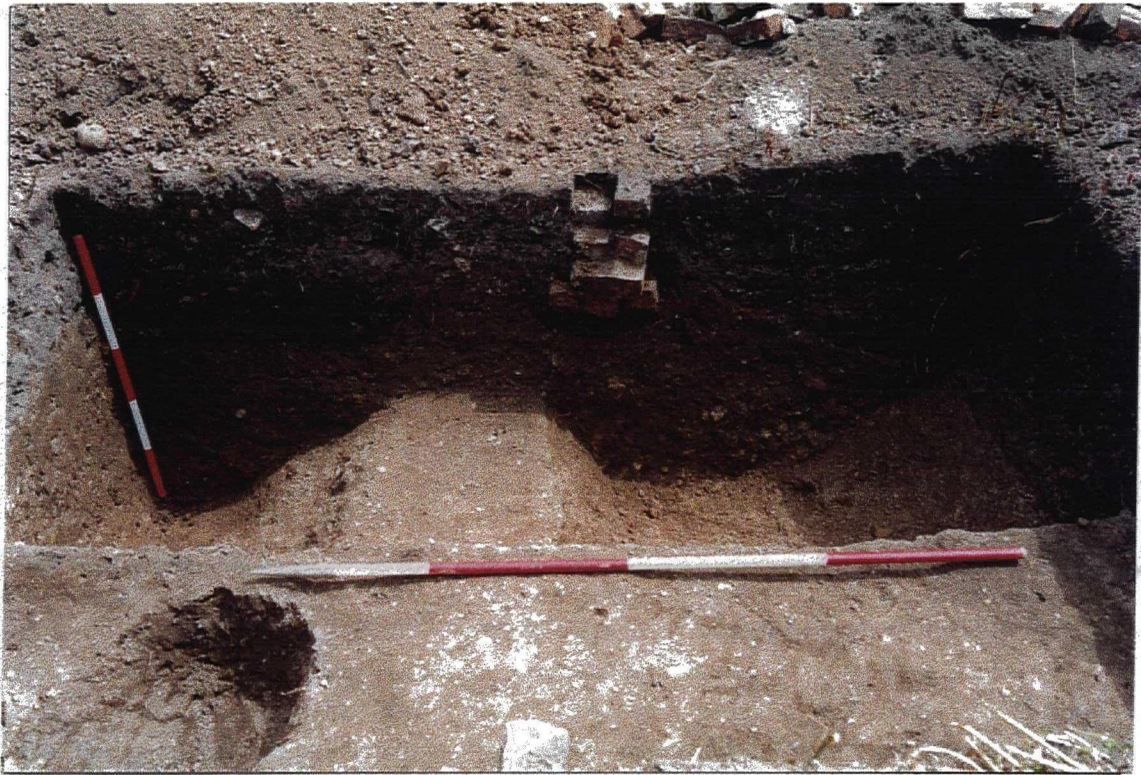

Plate 3. Trench 2. Phase 1 Cut Features. Facing west.



Plate 4. Trench 2. Phase 2 Cut Features and Wall 2003. Facing north.



Plate 5. Trench 3. Pit Cuts 3024, 3026. Facing west.



Plate 6. Trench 3. Mortar Floor Surface 3018. Facing east.



Plate 7. Trench 3. Cobble Surface 3015. Facing north.



Plate 8. Trench 4. North-west Facing Profile of Cut 4013. Facing South-east.



Plate 9. Trench 4. Walls 4003 and 4005. Facing south.



Plate 10. Trench 4. Cobble Surface 4002. Facing south.



Plate 11. Trench 5. Post Excavation Showing Cut Features and Modern Structures. Facing North-east.



Plate 12. Trench 5. Cobble Surface 5002. Facing South-west.



Plate 13. Trench 6. Post Excavation Showing all Cut Features and Structures.
Facing North-east.