

RESEARCH REPORT SERIES no. 24-2014

SOCKBURN HALL, SOCKBURN, DARLINGTON

TREE-RING ANALYSIS OF TIMBERS

SCIENTIFIC DATING REPORT

Alison Arnold and Robert Howard



INTERVENTION
AND ANALYSIS



ENGLISH HERITAGE

This report has been prepared for use on the internet and the images within it have been down-sampled to optimise downloading and printing speeds.

Please note that as a result of this down-sampling the images are not of the highest quality and some of the fine detail may be lost. Any person wishing to obtain a high resolution copy of this report should refer to the ordering information on the following page.

Research Report Series 24-2014

SOCKBURN HALL,
SOCKBURN,
DARLINGTON

TREE-RING ANALYSIS OF TIMBERS

Alison Arnold and Robert Howard

NGR: NZ 34966 07189

© English Heritage

ISSN 2046-9799 (Print)

ISSN 2046-9802 (Online)

The Research Report Series incorporates reports by the expert teams within the Investigation & Analysis Division of the Heritage Protection Department of English Heritage, alongside contributions from other parts of the organisation. It replaces the former Centre for Archaeology Reports Series, the Archaeological Investigation Report Series, the Architectural Investigation Report Series, and the Research Department Report Series.

Many of the Research Reports are of an interim nature and serve to make available the results of specialist investigations in advance of full publication. They are not usually subject to external refereeing, and their conclusions may sometimes have to be modified in the light of information not available at the time of the investigation. Where no final project report is available, readers must consult the author before citing these reports in any publication. Opinions expressed in Research Reports are those of the author(s) and are not necessarily those of English Heritage.

Requests for further hard copies, after the initial print run, can be made by emailing:

Res.reports@english-heritage.org.uk

or by writing to:

English Heritage, Fort Cumberland, Fort Cumberland Road, Eastney, Portsmouth PO4 9LD

Please note that a charge will be made to cover printing and postage.

SUMMARY

Analysis undertaken on pine and oak samples from the main house, coach house, mash house, and stables resulted in the construction of 14 site sequences, none of which could be dated.

At present the dating of Sockburn Hall must therefore rely on documentary and stylistic grounds only.

CONTRIBUTORS

Alison Arnold and Robert Howard

ACKNOWLEDGEMENTS

The Laboratory would like to thank Simon Taylor for his assistance in facilitating access and for sharing his invaluable knowledge of the building, Mr and Mrs Geary and Ms Gatheral for their hospitality and kindness in showing us around during the initial assessment phase and the subsequent sampling phase. Thanks are also given to Cathy Tyers and Shahina Farid of the English Heritage Scientific Dating Team for commissioning the analysis and also for their advice and assistance throughout the production of this report.

ARCHIVE LOCATION

North Yorkshire Historic Environment Record
North Yorkshire County Council
County Hall
Northallerton
North Yorkshire
DL7 8AH

DATE OF INVESTIGATION

2013

CONTACT DETAILS

Alison Arnold and Robert Howard
Nottingham Tree-ring Dating Laboratory
20 Hillcrest Grove
Sherwood
Nottingham NG5 1FT
roberthoward@tree-ringdating.co.uk
alisonarnold@tree-ringdating.co.uk

CONTENTS

Introduction	1
Hall roofs.....	1
Coach/mash house roofs	1
Stables	2
Sampling	2
Analysis and Results	2
Discussion.....	3
Tables	5
Figures	8
Data of Measured Samples	29
Appendix: Tree-Ring Dating.....	43
The Principles of Tree-Ring Dating	43
The Practice of Tree-Ring Dating at the Nottingham Tree-Ring Dating Laboratory	43
1. Inspecting the Building and Sampling the Timbers.....	43
2. Measuring Ring Widths.....	48
3. Cross-Matching and Dating the Samples.....	48
4. Estimating the Felling Date.....	49
5. Estimating the Date of Construction.....	50
6. Master Chronological Sequences.....	51
7. Ring-Width Indices.....	51
References	55

INTRODUCTION

Sockburn Hall is a Grade II* listed house located just north of the Church of All Saints in the parish of Sockburn, Darlington (Figs 1–3). The main body of the house is square in plan and of two storeys plus attics (Fig 4). The front of the house faces south-west and is of three bays; the outer ones of which project and have shaped gables. This is repeated on two of the other sides of the square (Fig 5). To the left or north-west of the main house are two further ranges at a lower level (Fig 6). Behind these is a brick extension and a series of other, mostly derelict, brick-built structures forming a courtyard.

Of particular interest within the house are the panels lining the 'dining room' which are thought to be dismantled French dowry chests (Fig 7). The framing holding them in place may date to the AD 1920s when the room was changed from a 'gun room' to 'dining room' but the panels are thought to be much older, although this date is unclear.

To the north of the house is the coach and mash house (Fig 8). The ground floor of the mash house is thought to be where the food for the horses was prepared, whilst the upstairs formed accommodation. To the west of the mash house are the remains of the stables (Fig 9).

The main house, coach, and mash house are thought to be of largely single-phase construction dating to *c* AD 1834: built by Sir Edward Blackett for his younger brother Henry Collingwood Blackett. Sockburn Hall is on the Heritage at Risk Register and English Heritage has commissioned project development work to help progress a new viable use for the Hall and its grounds.

Hall roofs

There are three ranges of roofs over the main body of the house, here known as south, north, and east ranges. Each is of simple common-rafter type with purlins and hip rafters at the junctions (Fig 10).

The lower range to the north (north-rear range) has a single, exposed crown-post truss with struts (Fig 11). The other half of this range (the back kitchen) has the remains of a ceiling which was unsafe to access. The lower range to the south (south-rear range) is bedroom space and has two exposed trusses, consisting of principal rafters and collars, between which are purlins (Fig 12).

Coach/mash house roofs

The roof over the coach house is again of simple common-rafter type with intermittent collars and purlins (Fig 13), and the roof of the mash house is of common-rafter type with hip rafters (Fig 14).

Stables

The stables no longer have a roof but the remains of a first-floor frame survives as do some post and rails associated with partitioning (Fig 15).

SAMPLING

A dendrochronological survey was requested by Simon Taylor, English Heritage Senior Investigator, Assessment Team North. It was hoped that this would provide dating evidence for, and identify the likely source of, the timber for the dower-chest panels. In addition, it was hoped to obtain independent dating evidence for the hall and coach/mash house to confirm or refute the hypothesis that all are largely of single-phase construction. The construction of these elements in the early nineteenth century is likely to have used imported conifers, the dendrochronological dating of which might also provide evidence for the origin of these timbers. The date of Sockburn Hall is such that the pine timbers used represent a period when imported Scandinavian and Baltic pine timbers were increasing in importance following an apparent influx of North American imports in the early nineteenth century, although this is a period for which there is very little dendrochronological evidence (Tyers pers comm). It was also hoped that dating of the red-brick construction would provide dating evidence for this undated part of the building. The only structural timbers found to be oak on site were some of the components of the partitioning within the stables.

Assessment showed there to be no suitable timbers within the red-brick extension which could be sampled and so no further work was undertaken in this area. Additionally, as it is possible that the panelling in the 'dining room' may be dismantled as works progress, it was decided to defer this analysis as dismantling would provide infinitely better access to the individual elements some time in the future.

A total of 73 timbers (67 pine; 6 oak) from various areas of the building was sampled by coring. Each sample was given the code SBR-N and numbered 1–73. The location of all samples was noted at the time of sampling and has been marked on Figures 16–20. Further details relating to the samples can be found in Table 1.

ANALYSIS AND RESULTS

Twelve samples, six from the main body of the house, one from the south rear-range roof, one from the coach house, two from the mash house, and two from the stables had too few rings for secure dating and so were discarded prior to measurement. The remaining 61 samples were prepared by sanding and polishing and their growth-ring widths measured; the data of these measurements are given at the end of the report. All samples were then compared with each other by the Litton/Zainodin grouping programme (see Appendix), resulting in 39 samples matching to form 14 groups.

The relevant samples were combined at their offset positions to form 14 site sequences (Figs 21–34). Attempts to date these site sequences and the remaining ungrouped sequences were unsuccessful and all remain undated despite comparing them not only with reference chronologies available from sites right across Britain but also those available from elsewhere in Europe and America.

DISCUSSION

It was hoped that undertaking tree-ring dating at Sockburn House would provide independent dating evidence to support that indicated by the documentary sources; this had suggested largely contemporary construction in *c* AD 1834. It is unfortunate that in this instance dendrochronology has been unsuccessful in providing dates for any of the timbers sampled.

The tree-ring analysis resulted in the formation of 14 (12 pine and 2 oak) separate site sequences. In all but two cases each site sequence is represented by samples from a single area, raising the possibility of different woodland sources being exploited for different areas. Thus, we have site sequence SBRNSQ01 which contains six samples from timbers of the east range of the main roof which all match each other very well and are clearly a discrete group of timbers. The exceptions to this are sequences SBRNSQ02 and SBRNSQ06; SBRNSQ02 contains two, south, rear-range samples, a coach house sample, and one from the stables whilst SBRNSQ06 consists of one sample each from the north-range roof, south range, and north-rear range.

Generally the better replicated and longer a site sequence is the greater the possibility of successful dating and this is especially true when dealing with softwood. The longest and best replicated site sequence created from the samples taken at Sockburn Hall is SBRNSQ01 which contains six samples and spans 240 rings. Apart from SBRNSQ02 which contains four samples, the rest of the site sequences have only two or three samples in them and are not particularly long in terms of softwood sequences, making the lack of dating perhaps predictable.

Slightly more surprising is the fact that none of the oak samples have been dated either. The four analysed oak samples grouped to form two separate site sequences (SBRNSQ13 and SBRNSQ14) of 153 and 122 rings, respectively. Oak sequences of these lengths would normally be expected to have a reasonable chance of successful dating. However, when looked at more closely it can be seen that the two samples represented by SBRNSQ13 (SBR-N71 and SBR-N72) match each other at $t=12.5$ and those by SBRNSQ14 (SBR-N67 and SBR-N70) at $t=10.1$. These values are of a level which may suggest in both cases a single tree provided the two timber elements represented. If this is the case then the probability of successful dating of these two site sequences would be reduced to that of individual samples, something which is notoriously difficult. Additionally, with the likelihood of these timbers dating to the first half of the nineteenth century or

later we are entering a period which is not well represented within the reference chronologies.

This lack of dating at Sockburn Hall is disappointing and is thought most likely due to the material being of a much more disparate nature than anticipated and potentially derived from multiple variable woodland sources. This would be compounded by the late date expected from these timbers and the paucity of reference material with which to compare them. Generally, it should be noted that, although successful dating of imported softwood timbers has been undertaken in England, research in this area is still in its infancy and has by chance focussed on late seventeenth- and eighteenth-century material. It would be hoped that as more work is undertaken the rate of success will increase and successful dating by dendrochronology of buildings such as Sockburn Hall may stand a greater chance in the future.

TABLES

Table 1: Details of tree-ring samples from Sockburn Hall, Sockburn, Darlington

Sample number	Sample location	Total rings*	Sapwood rings**	First measured ring date (AD)	Last heartwood ring date (AD)	Last measured ring date (AD)
Main Roofs						
North range						
SBR-N01	East hip rafter	152	33	----	----	----
SBR-N02	West hip rafter	NM	--	----	----	----
SBR-N03	West common rafter 2, gable	NM	--	----	----	----
SBR-N04	West common rafter 6, gable	NM	--	----	----	----
SBR-N05	East common rafter 7, gable	NM	--	----	----	----
SBR-N06	North common rafter 4	60	--	----	----	----
SBR-N07	South common rafter 5	70	--	----	----	----
SBR-N08	North common rafter 8	79	05	----	----	----
SBR-N09	North common rafter 13	64	--	----	----	----
SBR-N10	North common rafter 17	54	--	----	----	----
East range						
SBR-N11	North-east hip rafter, bay 1	142	--	----	----	----
SBR-N12	North-west hip rafter, bay 1	56	--	----	----	----
SBR-N13	South-east hip rafter, bay 1	111	64	----	----	----
SBR-N14	South-west hip rafter, bay 1	112	14	----	----	----
SBR-N15	East common rafter 3, bay 1	NM	--	----	----	----
SBR-N16	East common rafter 4, bay 1	NM	--	----	----	----
SBR-N17	North-west hip rafter, bay 2	115	--	----	----	----
SBR-N18	South-east hip rafter, bay 2	123	54	----	----	----
SBR-N19	South-west hip rafter, bay 2	98	--	----	----	----
South range						
SBR-N20	West common rafter 2, south gable	73	--	----	----	----
SBR-N21	East common rafter 2, south gable	57	--	----	----	----
SBR-N22	West common rafter 4, south gable	77	--	----	----	----

SBR-N23	East common rafter 5, south gable	88	--	----	----	----
SBR-N24	South common rafter 3	80	14	----	----	----
SBR-N25	South common rafter 4	59	13	----	----	----
SBR-N26	North common rafter 4	94	--	----	----	----
SBR-N27	South common rafter 5	62	--	----	----	----
SBR-N28	South common rafter 15	105	53	----	----	----
SBR-N29	South common rafter 17	86	--	----	----	----
SBR-N30	South-west hip rafter	61	02	----	----	----
Lower roofs						
North rear range						
SBR-N31	North principal rafter	66	--	----	----	----
SBR-N32	South principal rafter	66	--	----	----	----
SBR-N33	Tiebeam	58	21	----	----	----
South rear range						
SBR-N34	North principal rafter, truss 1	NM	--	----	----	----
SBR-N35	South principal rafter, truss 1	74	--	----	----	----
SBR-N36	Tiebeam, truss 1	84	18	----	----	----
SBR-N37	North principal rafter, truss 2	50	02	----	----	----
SBR-N38	South principal rafter, truss 2	125	26	----	----	----
SBR-N39	Tiebeam, truss 2	96	40C	----	----	----
SBR-N40	North purlin	69	07	----	----	----
Coach house						
SBR-N41	North common rafter 2, bay 1	62	16	----	----	----
SBR-N42	North rafter, truss 1	69	02	----	----	----
SBR-N43	North common rafter 4, bay 3	105	--	----	----	----
SBR-N44	South common rafter 4, bay 3	62	11	----	----	----
SBR-N45	South rafter, truss 3	77	14	----	----	----
SBR-N46	North common rafter 4, bay 5	NM	--	----	----	----
SBR-N47	North common rafter 6, bay 5	58	07	----	----	----
SBR-N48	North common rafter 8, bay 5	91	54	----	----	----
SBR-N49	North-west diagonal rafter, bay 5	73	40	----	----	----
SBR-N50	West common rafter 18, bay 5	51	--	----	----	----

SBR-N51	Collar, truss 5	114	--	----	----	----
SBR-N52	West common rafter 1, bay 6	79	13	----	----	----
SBR-N53	East common rafter 2, bay 6	84	37	----	----	----
SBR-N54	West common rafter 2, bay 6	97	48	----	----	----
SBR-N55	West common rafter 2, bay 7	97	22	----	----	----
SBR-N56	East common rafter 2, bay 8	74	21	----	----	----
SBR-N57	East common rafter 3, bay 8	51	07	----	----	----
SBR-N58	West common rafter 3, bay 8	93	01	----	----	----
SBR-N59	West rafter, truss 8	99	13	----	----	----
SBR-N60	North purlin	85	12	----	----	----
SBR-N61	South purlin	87	--	----	----	----
Mash house						
SBR-N62	North-east hip rafter	90	--	----	----	----
SBR-N63	North-west hip rafter	NM	--	----	----	----
SBR-N64	South-east hip rafter	NM	--	----	----	----
SBR-N65	Joist 9	97	28	----	----	----
SBR-N66	Joist 10	95	22	----	----	----
Stables						
SBR-N67	Post A - oak	122	h/s	----	----	----
SBR-N68	Post B - oak	NM	--	----	----	----
SBR-N69	Post C - oak	NM	--	----	----	----
SBR-N70	Post D - oak	119	--	----	----	----
SBR-N71	Post E - oak	106	--	----	----	----
SBR-N72	Post F - oak	146	h/s	----	----	----
SBR-N73	Post G - pine	78	--	----	----	----

*NM = not measured

**h/s = heartwood/sapwood boundary is the last-measured ring

C = complete sapwood retained on sample, last measured ring is the felling date

FIGURES



Figure 1: Map to show the general location of Sockburn, circled. © Crown Copyright and database right 2014. All rights reserved. Ordnance Survey Licence number 100024900



Figure 2: Map to show the general location of Sockburn Hall, arrowed. © Crown Copyright and database right 2014. All rights reserved. Ordnance Survey Licence number 100024900



Figure 3: Map to show the location of Sockburn Hall. © Crown Copyright and database right 2014. All rights reserved. Ordnance Survey Licence number 100024900



Figure 4: Plan of Sockburn Hall with areas investigated within the house outlined, and the location of the roof truss in the north-rear range marked (Blackett-Ord Conservation)



Figure 5: Sockburn Hall, main block, photograph taken from the east (Alison Arnold)



Figure 6: Rear ranges of the house, photograph taken from the north-west (Alison Arnold)



Figure 7: Panels lining the 'dining room', photograph taken from the south-east (Alison Arnold)



Figure 8: Coach house (to the right) and mash house (to the left), photograph taken from the south (Alison Arnold)



Figure 9: Ruined stables, photograph taken from the south-east (Alison Arnold)



Figure 10: Sockburn Hall, north range roof, photograph taken from the south-east (Alison Arnold)



Figure 11: Sockburn Hall, north rear-range roof, photograph taken from the north-west (Alison Arnold)



Figure 12: Sockburn Hall, south-rear range, truss 1, photograph taken from the north-west (Alison Arnold)



Figure 13: Coach house, roof, photograph taken from the north (Alison Arnold)



Figure 14: The mash house roof, photograph taken from the north (Alison Arnold)



Figure 15: The stables, surviving partitioning, photograph taken from the east (Alison Arnold)

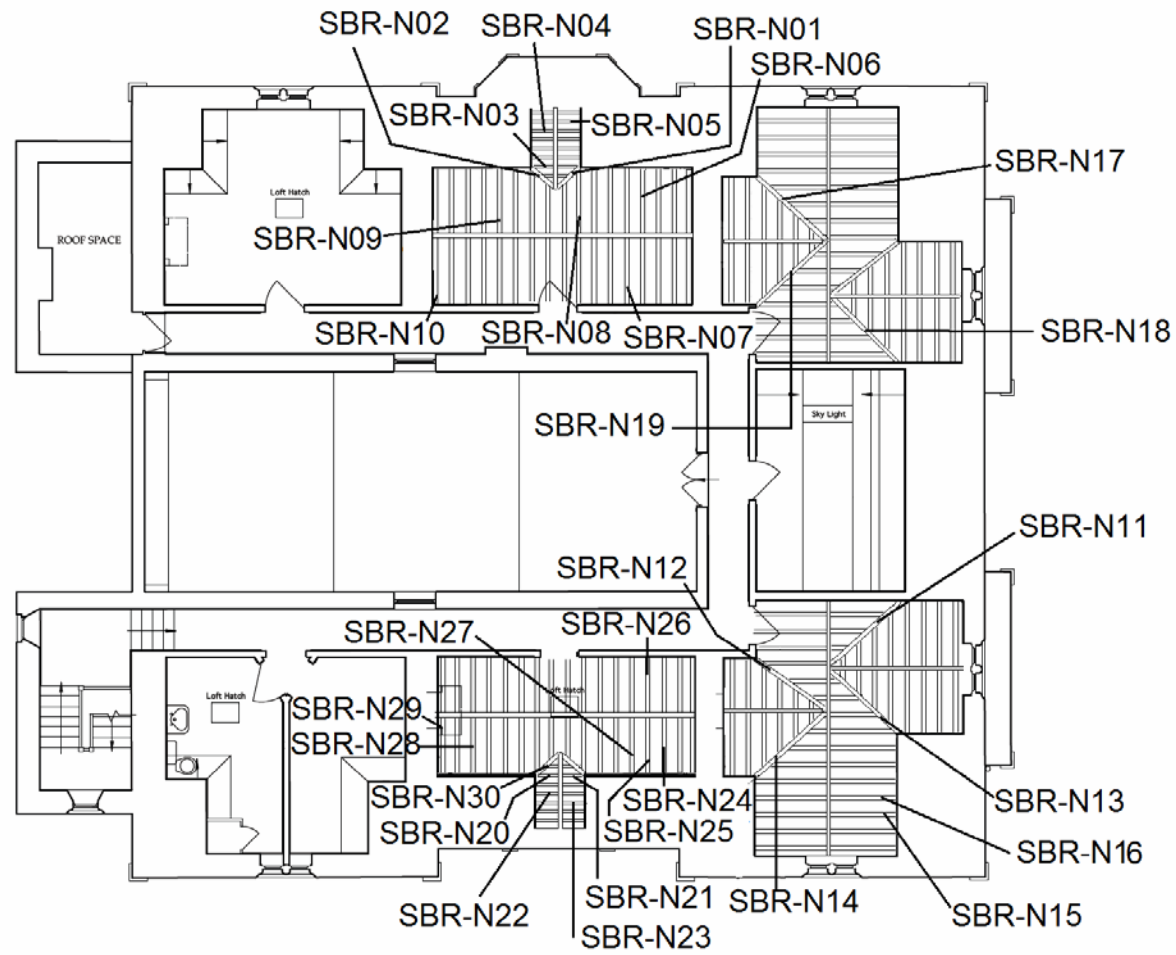

Figure 16: Second-floor plan, showing the location of samples SBR-N01–30 (Blackett-Ord Conservation)

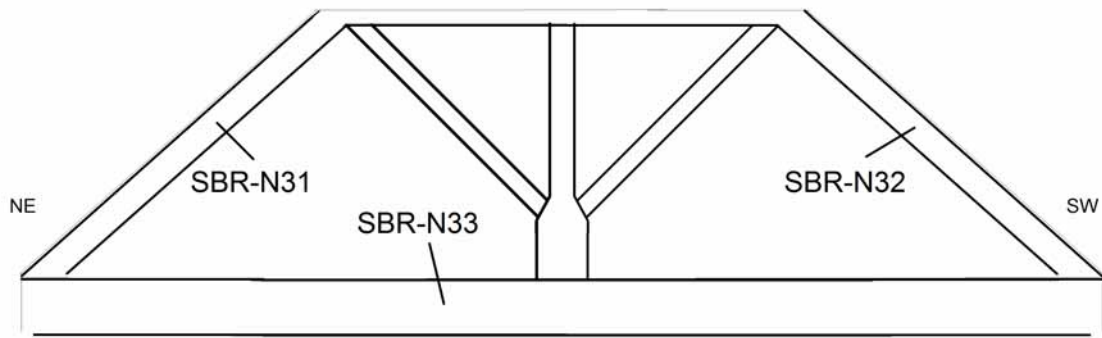

Figure 17: Sketch of the truss in the north-rear range, showing the location of samples SBR-N31–33

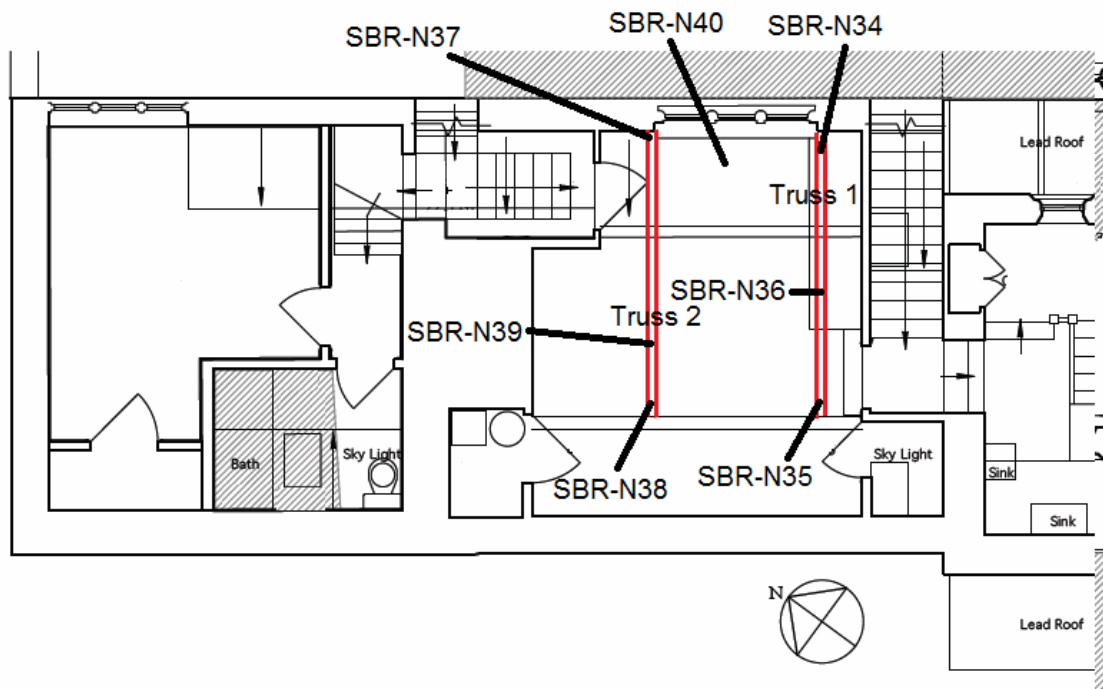

Figure 18: First-floor plan showing the position of trusses in the south-rear range and the location of samples SBR-N34–40 (Blackett-Ord Conservation)

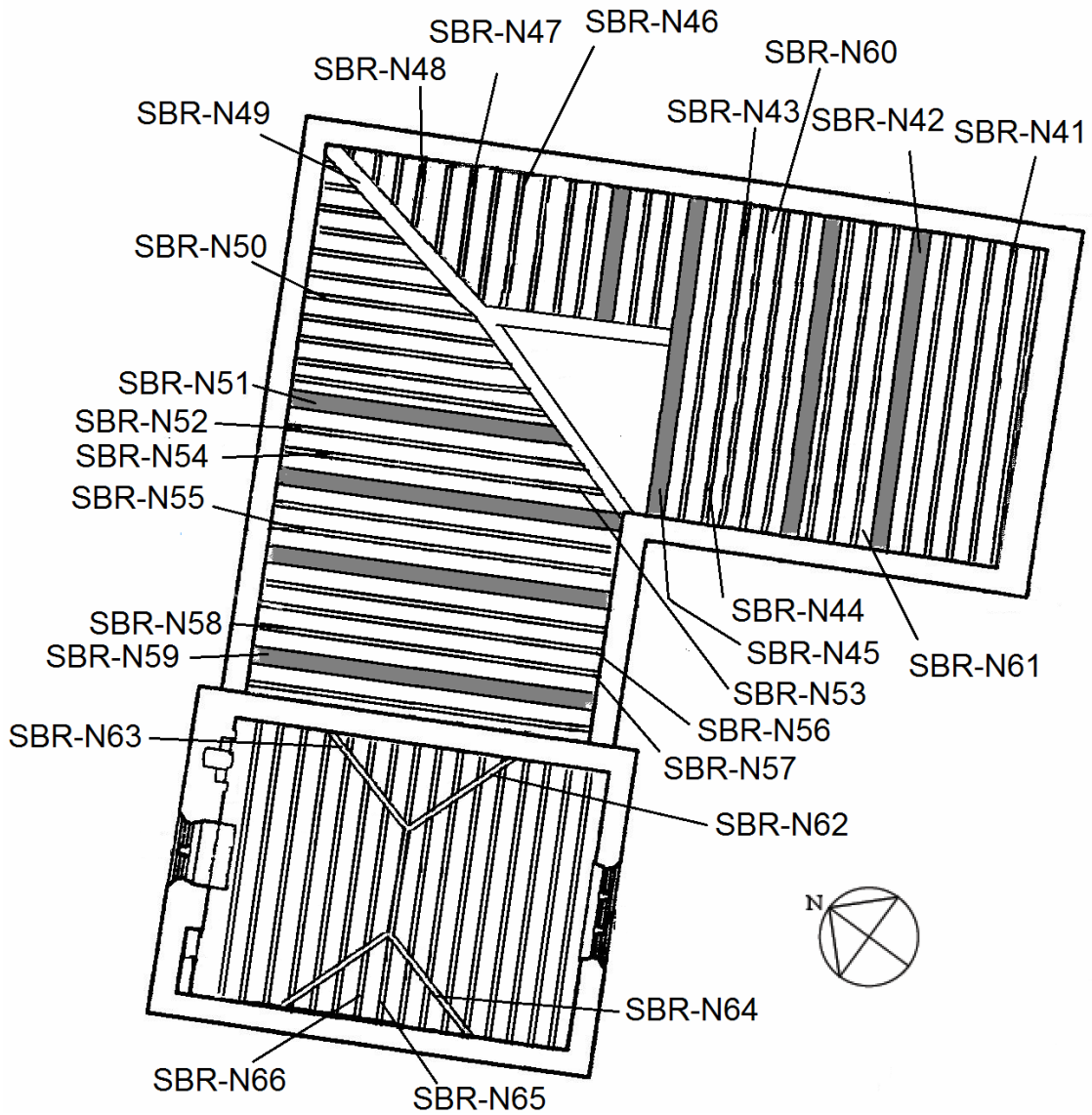

Figure 19: First-floor plan, showing the location of samples SBR-N41–66 (Blackett-Ord Conservation)

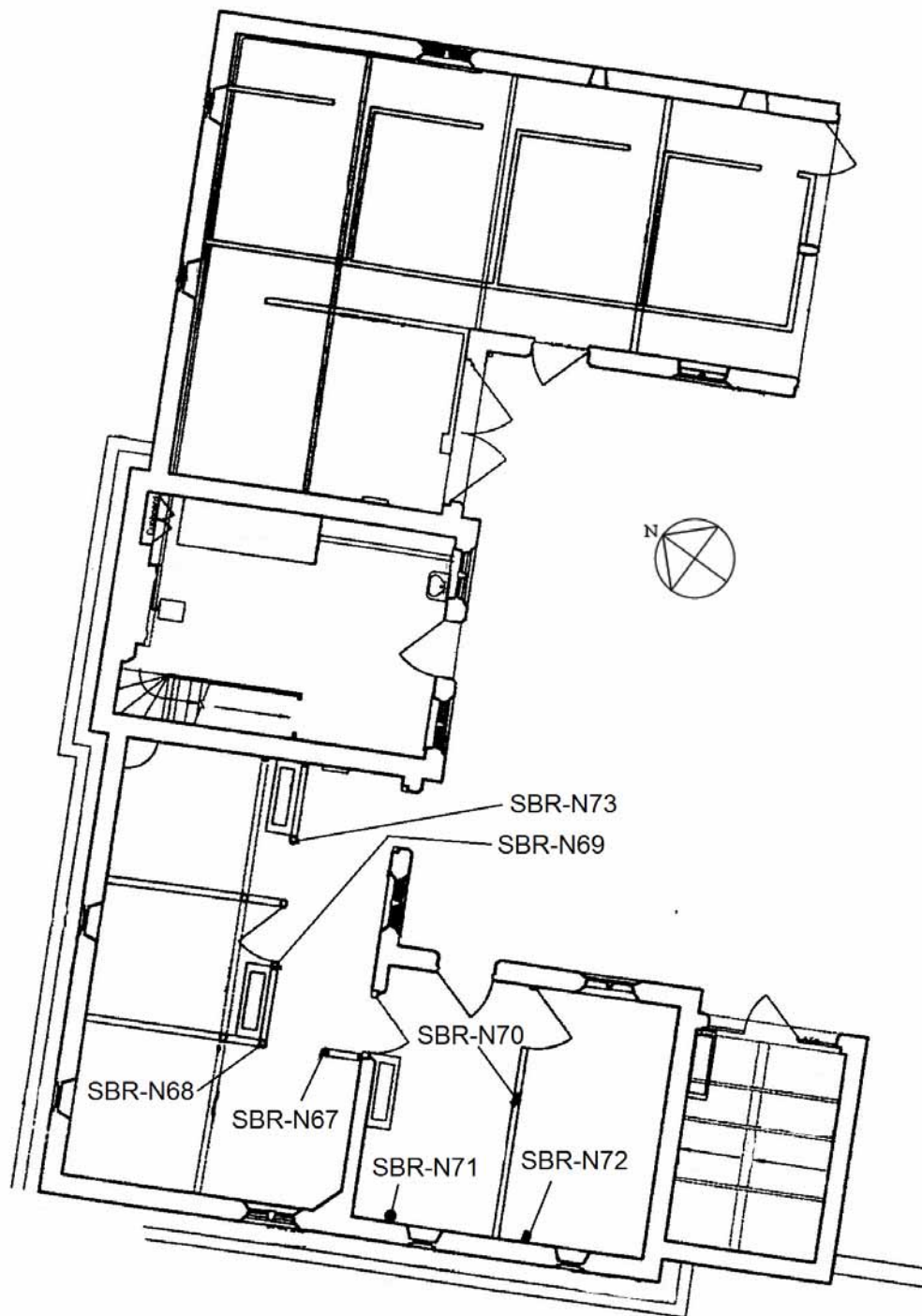

Figure 20: Ground-floor plan of the coach/mash houses and stables, showing the location of samples SBR-N67–73

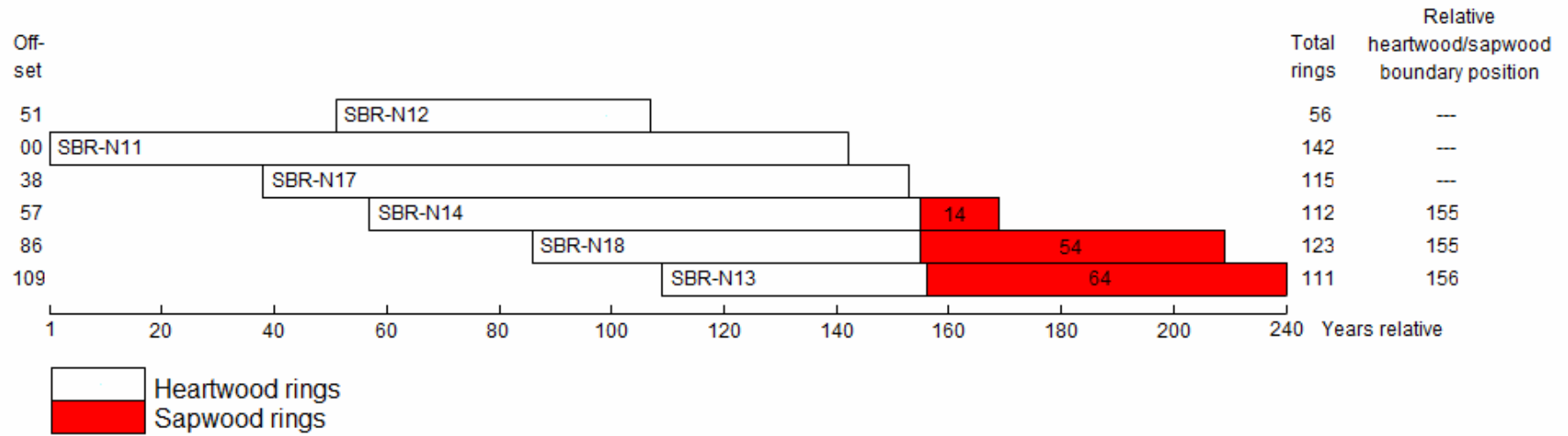

Figure 21: Bar diagram of samples in site sequence SBRNSQ01

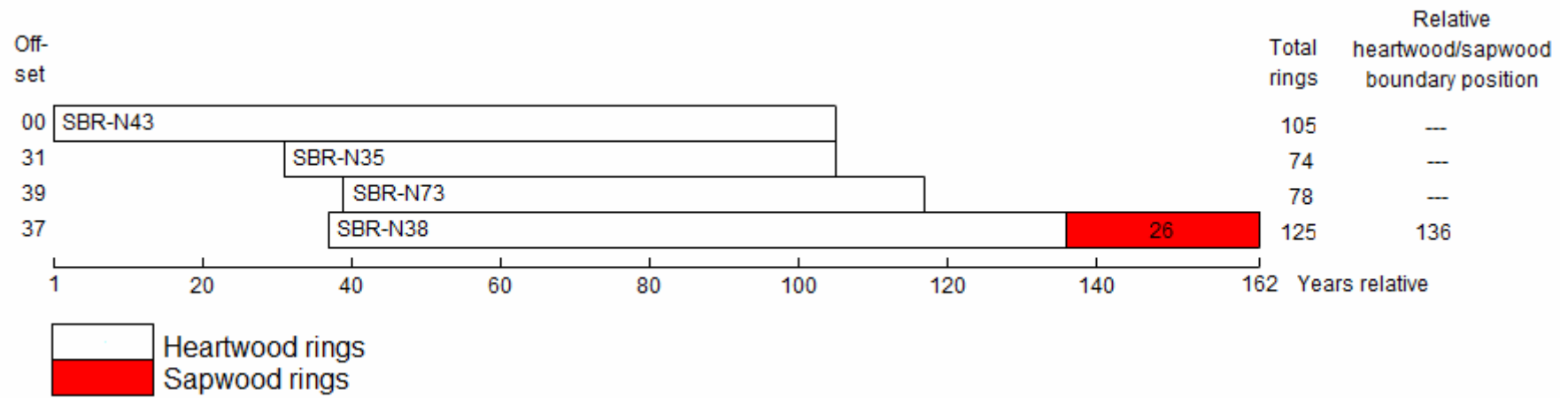

Figure 22: Bar diagram of samples in site sequence SBRNSQ02

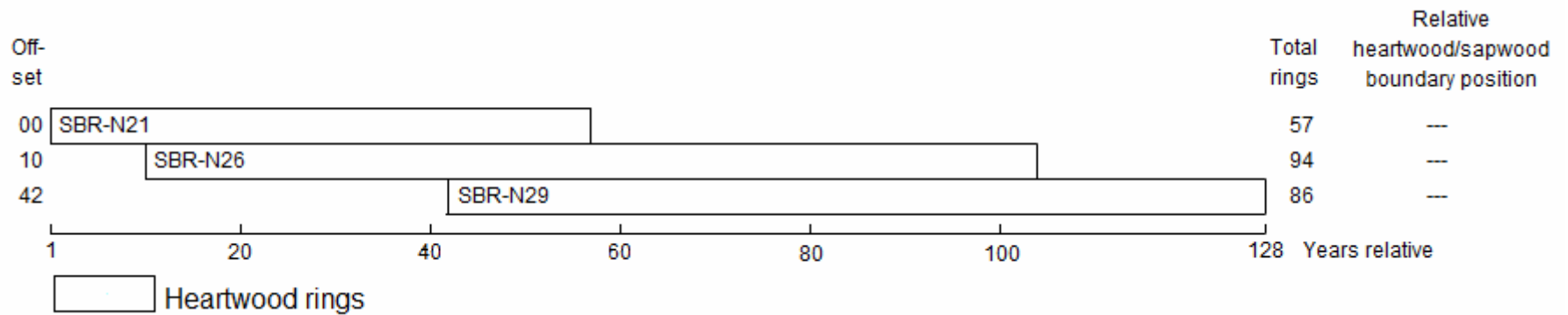

Figure 23: Bar diagram of samples in site sequence SBRNSQ03

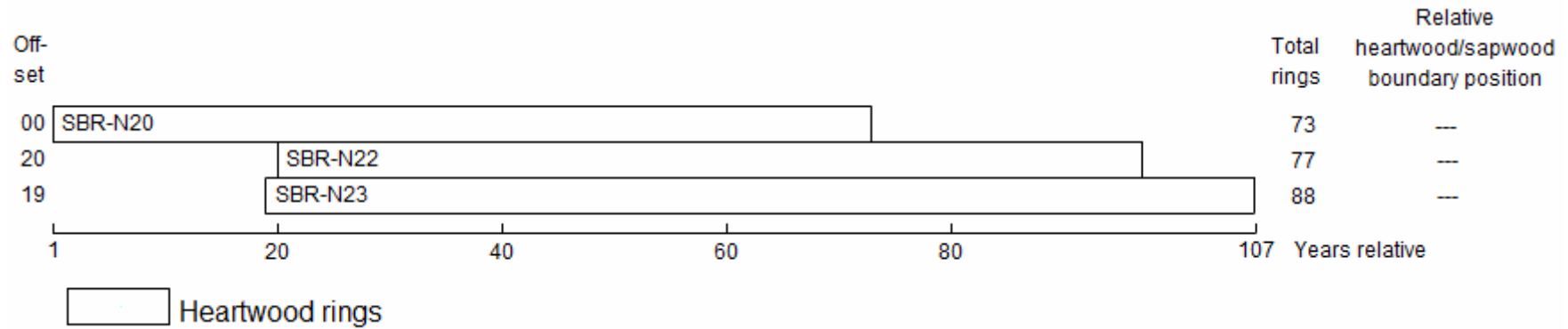

Figure 24: Bar diagram of samples in site sequence SBRNSQ04

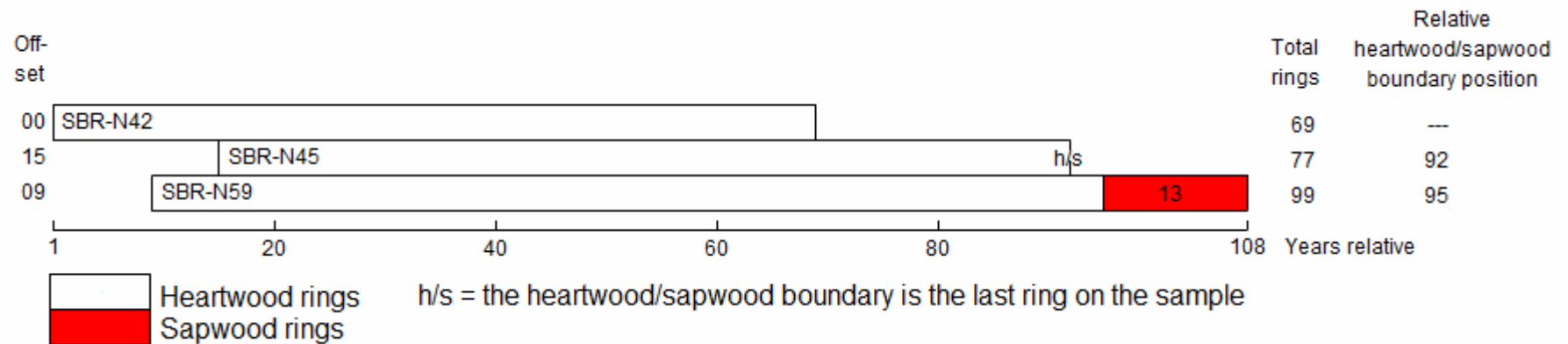

Figure 25: Bar diagram of samples in site sequence SBRNSQ05

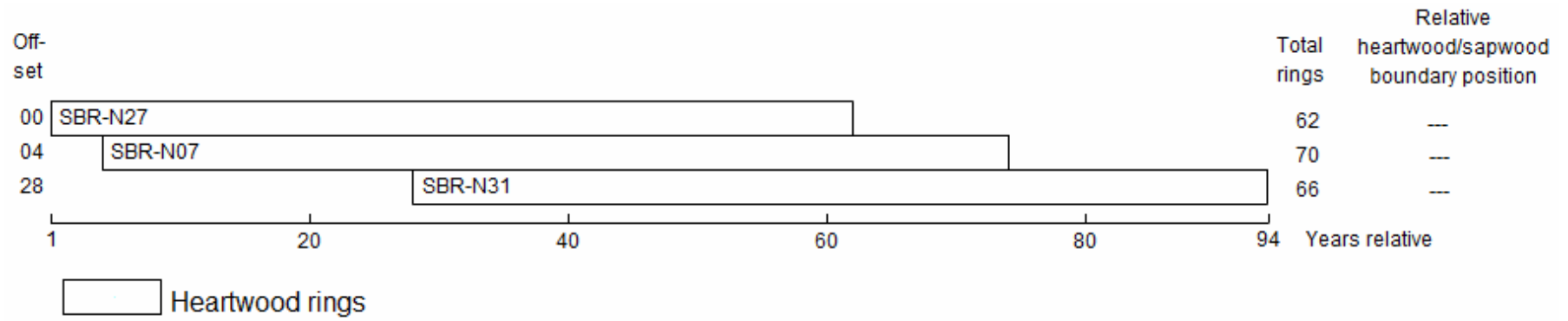

Figure 26: Bar diagram of samples in site sequence SBRNSQ06

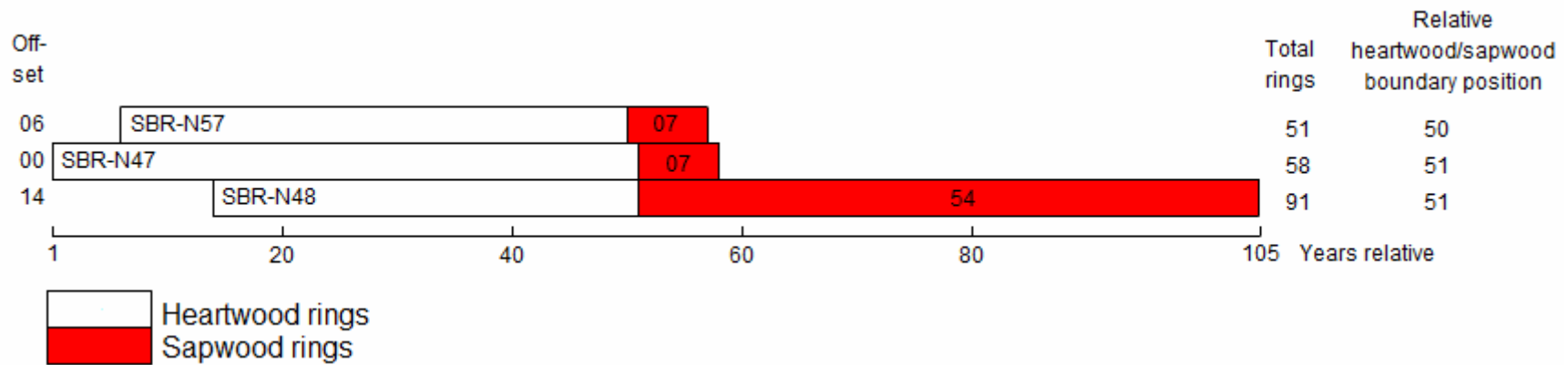

Figure 27: Bar diagram of samples in site sequence SBRNSQ07

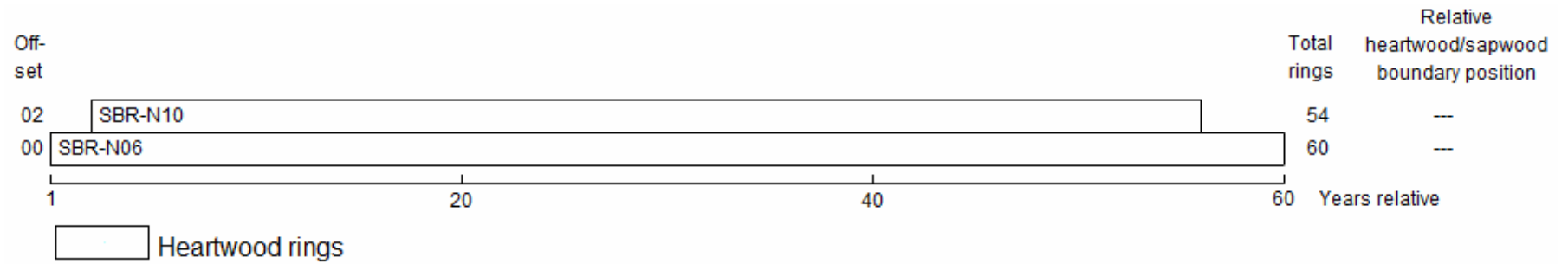

Figure 28: Bar diagram of samples in site sequence SBRNSQ08

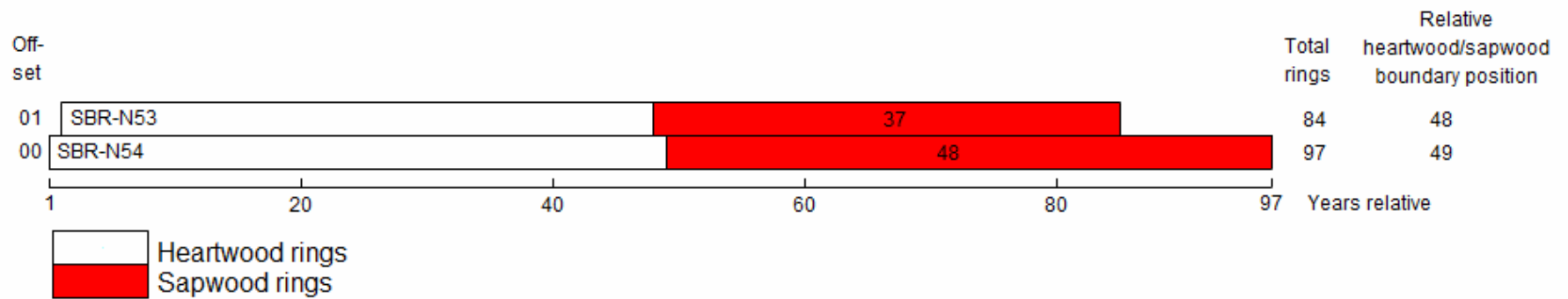

Figure 29: Bar diagram of samples in site sequence SBRNSQ09

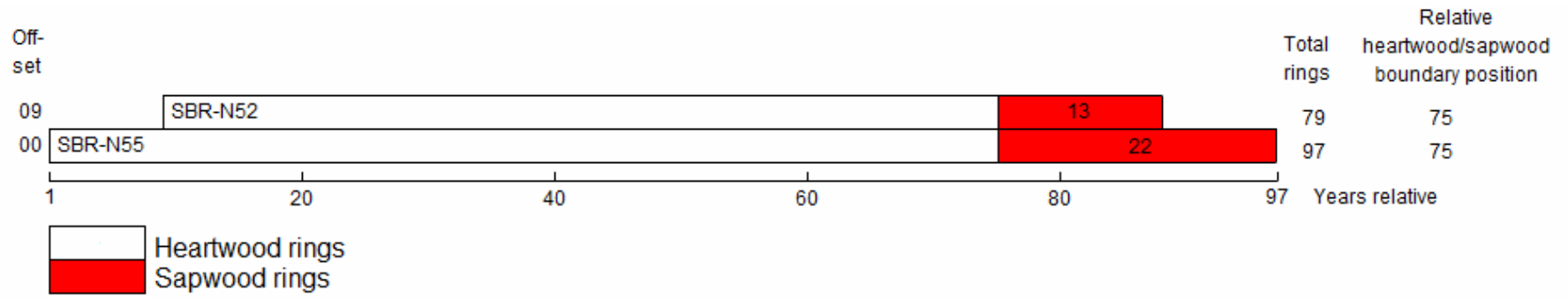

Figure 30: Bar diagram of samples in site sequence SBRNSQ10

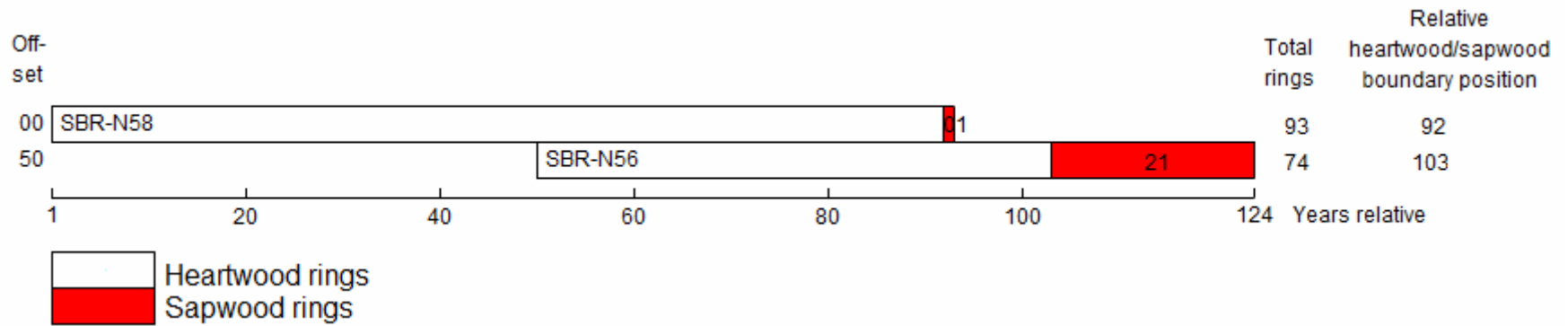

Figure 31: Bar diagram of samples in site sequence SBRNSQ11

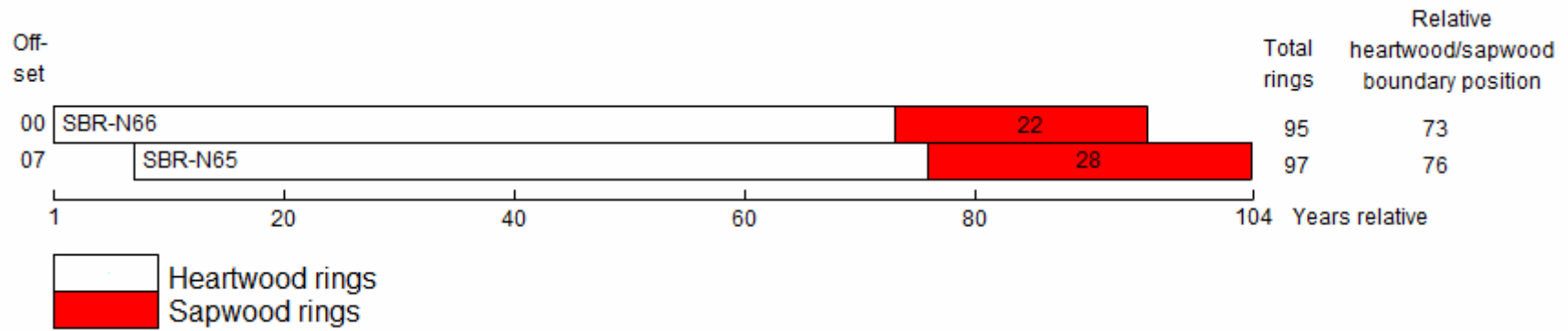

Figure 32: Bar diagram of samples in site sequence SBRNSQ12

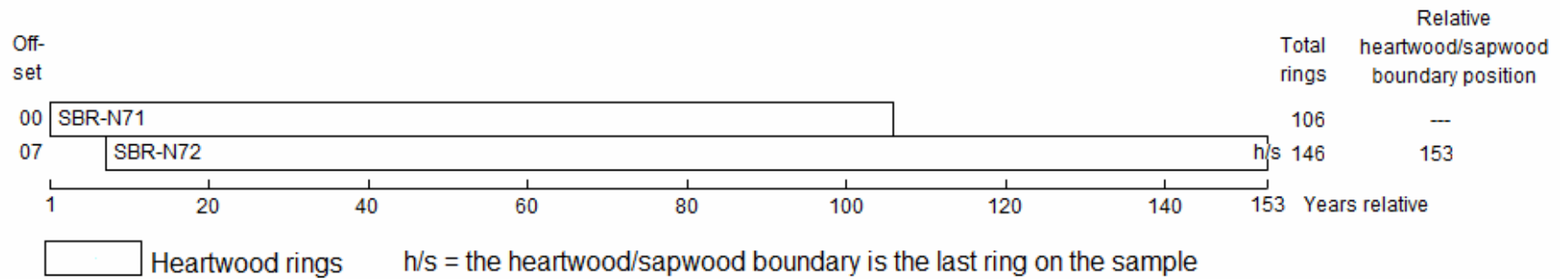

Figure 33: Bar diagram of samples in site sequence SBRNSQ13

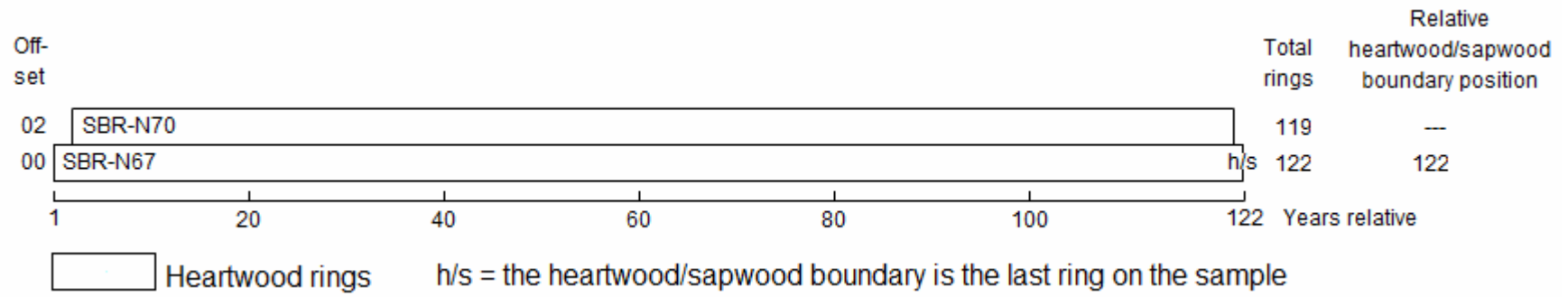

Figure 34: Bar diagram of samples in site sequence SBRNSQ14

DATA OF MEASURED SAMPLES

Measurements in 0.01mm units

SBR-N01A 152

142 152 179 172 182 154 159 148 138 134 102 121 86 94 80 89 72 77 94 105
109 104 98 110 97 112 117 93 86 102 118 83 79 84 74 38 41 41 48 34
49 44 34 28 16 23 34 31 42 42 51 24 41 28 42 35 36 31 32 42
50 60 47 49 59 32 61 73 61 69 75 64 71 72 36 57 53 47 47 54
73 61 63 45 35 32 37 26 34 27 47 49 56 58 49 47 57 56 56 45
58 49 42 39 48 51 42 49 67 54 47 41 68 89 81 54 58 53 57 63
78 64 65 49 37 24 19 45 37 46 52 55 66 99 88 85 113 80 62 38
37 28 35 63 52 49 62 48 34 32 42 51

SBR-N01B 152

142 152 185 182 181 155 157 151 149 139 110 122 76 104 82 81 63 84 87 108
111 105 106 112 96 107 112 107 86 101 112 89 82 81 70 41 46 35 47 40
54 36 31 32 16 35 36 25 38 41 42 22 40 44 40 35 34 31 31 46
49 56 46 43 56 37 59 72 61 75 70 63 76 68 36 55 57 54 52 44
85 76 56 42 33 36 30 25 37 33 54 46 50 58 46 41 55 54 47 49
52 48 42 41 53 51 43 56 57 52 44 44 67 93 71 52 56 53 63 61
76 65 62 51 32 23 24 43 33 49 54 53 72 94 88 82 108 79 66 33
37 27 36 62 52 48 67 46 30 34 36 49

SBR-N06A 60

215 220 167 184 225 239 241 196 209 182 147 116 126 115 142 117 108 117 146 178
186 128 170 147 138 146 138 132 154 189 222 231 225 149 133 108 110 105 82 102
137 121 162 204 183 146 108 90 57 80 78 60 77 127 92 45 40 35 34 39

SBR-N06B 57

169 183 222 246 234 196 205 185 151 114 113 122 134 120 105 119 149 181 186 125
172 148 141 146 143 131 153 192 229 225 229 147 138 113 109 109 88 98 133 119
161 205 194 156 105 83 54 72 85 62 83 116 101 42 46 68 47

SBR-N07A 70

265 328 245 244 283 240 247 227 188 200 230 259 250 212 161 137 181 138 157 141
140 162 99 153 107 105 98 79 110 121 171 198 145 136 170 146 119 111 79 110
113 108 112 92 94 99 130 98 108 127 146 95 66 71 106 96 79 90 130 142
91 108 68 95 119 169 115 91 76 105

SBR-N07B 70

262 331 245 232 287 238 258 228 186 194 230 261 245 216 158 149 179 135 161 135
135 161 95 152 111 101 113 67 116 127 166 205 141 134 169 145 118 113 82 110
113 109 111 91 96 96 128 99 111 131 149 95 66 71 105 95 80 91 132 140
89 114 62 96 114 168 119 94 77 97

SBR-N08A 79

290 491 470 261 198 195 229 239 251 279 272 245 161 105 88 129 146 157 147 136
137 199 212 194 123 124 95 93 136 124 126 123 170 123 141 123 145 188 196 128
144 186 168 114 135 128 89 103 107 177 126 113 105 100 94 115 141 125 151 119
132 107 183 186 167 138 146 120 90 177 117 129 96 122 160 156 143 195 180

SBR-N08B 79

291 489 472 259 208 191 232 237 253 285 269 240 166 99 93 126 151 149 151 131
140 197 205 190 125 122 102 97 136 136 122 121 163 123 135 131 142 183 197 126
146 184 168 115 138 126 88 104 108 178 122 109 108 95 89 121 139 127 146 127
134 116 177 185 164 140 142 130 87 178 120 129 96 110 169 151 148 204 194

SBR-N09A 64

325 304 317 417 489 494 268 203 216 211 222 235 180 186 143 127 118 128 110 94

113 134 69 89 84 106 177 174 179 151 172 155 148 135 118 113 117 104 133 320
273 277 242 200 167 156 119 96 138 149 123 91 93 124 142 152 144 89 86 141
253 371 421 264

SBR-N09B 64

328 298 330 416 469 489 279 195 219 215 221 238 187 200 153 133 107 139 109 92
118 129 71 87 86 105 172 181 173 159 174 137 157 138 116 114 120 101 134 323
271 272 246 202 167 151 115 98 134 155 123 93 100 128 148 160 137 95 86 130
270 375 429 255

SBR-N10A 54

173 259 230 256 244 160 173 168 145 129 119 109 101 102 69 84 102 150 162 118
152 129 188 137 137 136 132 163 203 191 183 112 113 98 85 101 82 87 116 108
169 184 143 129 126 92 57 64 67 53 69 111 153 92

SBR-N10B 54

187 263 228 251 243 191 162 176 143 118 114 104 105 101 71 86 111 150 164 115
154 131 189 138 136 139 128 164 204 193 180 118 116 97 102 101 81 83 123 106
167 184 149 127 138 84 66 61 75 56 68 124 150 96

SBR-N11A 142

142 147 149 149 177 141 157 142 143 119 137 186 158 150 170 122 119 181 222 137
155 114 159 193 159 185 197 204 113 90 149 122 165 158 97 67 62 93 151 130
143 123 113 114 141 157 63 142 89 83 114 95 107 96 77 82 105 32 17 13
14 31 61 111 142 120 112 103 99 103 99 112 194 216 120 211 158 121 121 135
215 198 207 180 177 156 102 154 109 144 116 87 141 131 58 79 63 54 74 49
19 51 58 61 43 67 52 76 80 112 111 155 256 241 235 207 164 163 159 79
70 74 66 54 65 65 39 61 61 82 74 81 89 74 57 68 70 118 160 123
79 104

SBR-N11B 142

189 149 144 161 176 133 142 138 143 114 136 181 145 143 170 122 119 177 218 138
153 108 159 189 158 166 183 190 111 94 145 122 168 156 95 81 66 103 142 128
133 124 111 108 138 149 63 150 84 89 110 89 106 97 84 72 102 25 20 12
16 30 58 109 143 122 113 97 97 111 100 106 168 214 130 218 157 115 118 136
210 195 202 176 173 155 108 145 100 139 115 88 127 141 59 76 62 57 77 26
19 51 55 55 49 62 55 78 79 110 109 151 257 237 211 206 164 163 155 82
67 71 71 52 63 66 41 62 59 84 78 76 89 78 50 71 72 117 161 117
81 107

SBR-N12A 56

129 144 126 158 191 175 130 156 44 17 25 51 80 170 124 122 142 106 76 93
97 101 142 115 163 170 124 147 167 151 144 176 114 136 128 143 165 91 84 47
75 101 44 59 49 35 53 57 14 14 37 63 76 56 75 78

SBR-N12B 56

130 138 121 157 188 173 127 155 42 17 21 55 77 167 129 117 140 109 73 95
91 100 142 107 159 173 123 150 167 149 141 174 113 138 132 132 166 94 80 50
73 102 46 54 51 37 49 52 13 14 44 59 80 55 69 77

SBR-N13A 111

56 104 128 215 253 162 102 111 114 168 137 126 136 120 100 88 88 51 67 69
72 122 125 96 68 44 75 88 168 182 72 55 67 85 70 54 61 95 94 56
75 98 113 90 114 100 90 89 101 111 70 51 71 48 59 67 76 56 75 131
93 99 48 65 79 42 55 62 51 63 66 45 47 57 47 56 59 73 46 62
39 38 47 47 34 45 73 79 40 59 80 79 77 85 89 74 71 42 69 54
42 67 41 59 83 87 53 70 24 30 38

SBR-N13B 111

61 99 125 215 254 164 105 110 116 144 146 122 146 103 88 84 95 54 79 64
68 119 107 91 62 50 71 90 169 189 77 54 79 98 73 55 65 98 86 61
68 98 120 99 110 102 83 88 88 115 69 53 83 42 66 68 74 51 77 134

78 96 50 65 73 44 54 67 56 59 68 44 43 57 57 55 61 70 43 61
37 42 49 47 32 44 69 77 46 57 79 81 82 77 90 68 74 41 70 57
38 70 37 58 92 74 56 67 35 28 36

SBR-N14A 112

121 30 22 9 28 55 124 138 111 82 81 80 78 91 77 117 107 84 144 133
109 132 155 195 154 140 141 163 165 151 225 126 102 69 88 97 69 53 61 61
56 63 20 22 49 77 60 61 78 61 89 84 90 114 137 187 209 244 277 166
194 170 127 82 108 98 75 88 84 63 70 79 98 98 95 87 60 50 56 65
96 121 83 67 80 89 73 95 86 82 67 67 70 125 121 73 102 96 72 89
103 106 69 57 56 48 66 76 71 47 68 90

SBR-N14B 112

82 26 18 19 27 54 105 130 101 89 82 82 76 93 79 124 113 89 132 136
111 144 131 199 152 133 154 178 161 149 219 120 101 69 93 105 69 58 58 58
54 65 22 24 43 73 72 64 86 59 89 82 93 114 141 187 209 253 278 165
196 170 111 74 103 106 84 89 83 64 68 79 102 99 92 90 59 47 61 66
101 119 82 67 83 85 76 90 84 84 72 63 72 118 127 76 96 98 80 84
101 112 72 56 57 57 67 72 67 48 67 93

SBR-N17A 115

195 184 162 108 117 173 207 303 221 233 160 145 135 98 110 150 120 95 211 46
26 12 21 32 123 175 212 187 199 200 135 106 94 94 95 93 104 147 200 158
157 162 194 161 176 138 121 84 127 155 93 75 59 105 96 82 67 72 59 65
63 21 20 39 78 72 61 68 87 98 96 140 194 233 300 209 175 115 101 124
141 102 72 95 90 85 106 82 64 64 75 105 84 94 111 109 63 71 77 129
151 105 83 93 107 121 129 126 130 80 113 100 138 127 104

SBR-N17B 115

207 192 161 116 118 126 215 310 229 232 164 146 137 98 112 156 123 102 214 51
26 15 20 32 119 175 211 185 203 204 138 103 99 90 100 92 105 153 185 157
154 178 186 162 183 134 122 87 122 155 91 80 62 103 104 81 64 79 51 72
64 18 20 39 79 72 62 71 85 99 96 138 197 229 303 208 179 116 100 119
146 103 71 93 96 82 105 84 63 65 78 96 87 96 110 109 64 63 77 131
153 106 90 90 103 119 125 133 127 81 107 92 138 128 106

SBR-N18A 123

108 198 103 153 112 121 170 111 86 105 81 110 104 18 29 49 135 99 87 71
77 135 138 118 140 202 321 203 141 86 87 139 168 106 103 74 80 64 72 97
64 64 69 78 56 71 86 77 44 60 50 110 144 81 71 90 90 111 116 116
113 101 76 87 116 115 114 175 145 135 102 108 117 59 58 96 59 85 113 116
80 125 142 99 112 50 100 99 54 79 96 81 79 114 77 64 77 74 73 100
111 56 63 53 59 58 50 40 63 94 57 46 54 63 73 76 79 59 44 48
33 51 54

SBR-N18B 123

113 203 99 149 115 117 185 106 91 99 101 92 91 20 21 54 127 107 76 81
71 133 155 124 138 204 320 201 144 85 83 135 166 112 88 78 75 65 78 101
69 68 61 81 57 68 92 73 45 51 71 107 127 80 69 91 97 98 123 114
102 98 71 84 125 130 113 161 149 146 102 114 115 63 57 90 58 86 115 119
79 121 143 94 101 49 111 97 59 83 95 86 79 114 74 60 77 76 72 93
104 66 61 51 53 69 48 36 65 89 62 47 51 64 78 72 77 65 51 45
32 64 59

SBR-N19A 98

205 242 195 207 194 148 150 236 151 138 132 138 154 179 147 150 95 91 96 85
32 24 35 93 90 106 96 134 190 133 120 156 157 122 98 102 96 79 144 147
107 128 113 67 130 139 129 104 152 127 56 78 95 101 114 68 50 51 70 125
98 86 81 103 85 106 118 82 101 88 88 105 103 123 102 91 77 105 32 27
16 26 40 80 95 56 113 93 62 70 63 74 122 168 110 196 149 127

SBR-N19B 98

200 244 183 205 196 155 153 235 152 142 121 142 145 187 159 150 103 88 96 84
30 30 44 83 94 103 95 135 196 135 123 150 156 123 98 104 95 82 145 150
110 123 109 75 132 135 128 97 160 123 60 73 94 109 118 69 46 54 68 114
92 96 82 114 81 110 122 76 105 84 94 107 102 126 95 94 77 110 28 23
18 25 43 81 95 68 111 87 65 70 70 67 127 175 110 195 158 123

SBR-N20A 73

377 436 236 372 459 358 252 250 303 323 261 325 275 309 218 241 234 238 299 259
168 242 225 168 159 176 227 161 100 124 120 146 147 165 136 154 249 220 171 168
156 102 102 92 131 146 129 188 160 163 139 71 141 142 119 144 110 148 163 104
72 162 106 42 39 50 63 82 80 104 127 91 64

SBR-N20B 73

361 434 242 377 449 363 246 264 304 324 235 327 273 311 215 243 237 238 300 252
166 241 225 174 165 174 220 161 105 122 129 153 136 169 130 158 250 217 159 162
162 102 104 94 134 143 130 183 162 167 139 73 139 146 119 144 112 145 161 107
74 163 105 43 38 52 64 82 77 109 122 97 63

SBR-N21A 57

303 283 226 239 243 290 193 278 264 276 279 346 230 292 201 170 157 189 228 187
159 194 201 223 210 180 133 168 156 198 175 155 194 155 142 112 184 157 192 216
127 104 114 133 152 146 137 123 91 123 132 131 147 119 134 120 119

SBR-N21B 57

335 282 232 235 247 288 193 278 260 276 278 341 229 293 199 169 164 188 226 181
156 193 207 237 204 172 130 165 160 193 178 159 188 155 139 118 174 152 196 217
128 108 122 125 158 147 143 120 96 119 133 134 146 121 130 120 122

SBR-N22A 77

141 231 158 127 102 128 126 111 80 124 144 154 125 122 113 154 268 216 205 273
265 173 150 105 146 204 142 216 131 146 141 75 94 121 111 151 114 120 117 76
56 125 69 41 55 58 72 81 72 97 113 65 55 61 68 93 91 74 83 84
90 82 89 67 76 87 105 80 58 56 47 70 54 35 39 38 35

SBR-N22B 77

140 234 154 123 106 154 109 103 81 126 155 150 125 115 120 158 243 208 217 270
266 170 148 101 153 197 146 214 118 142 141 77 99 106 105 148 116 111 126 76
60 123 71 41 57 57 75 75 76 99 109 67 57 59 67 93 92 73 85 84
86 83 91 62 78 90 103 75 62 54 47 71 50 40 36 42 40

SBR-N23A 88

217 211 296 242 161 115 136 128 129 99 142 150 163 113 165 114 122 173 158 169
187 110 115 131 117 174 160 150 166 156 146 160 76 122 114 130 128 112 132 132
109 75 139 74 37 52 61 78 86 74 146 166 165 97 104 112 144 158 191 133
101 119 140 123 118 94 110 146 125 80 80 77 123 94 43 38 32 42 50 50
48 56 39 51 61 67 63 113

SBR-N23B 88

226 218 295 246 162 114 129 133 127 93 151 144 157 122 173 116 125 172 165 167
191 117 112 139 119 168 164 144 155 159 149 161 72 125 107 136 126 119 141 132
117 81 143 76 37 53 61 83 80 81 146 162 161 97 103 108 140 162 187 141
96 121 150 129 114 97 109 148 128 81 78 79 120 99 40 38 37 44 51 51
48 61 43 44 67 60 59 127

SBR-N24A 80

171 116 100 103 113 120 162 154 185 191 191 139 132 94 101 137 156 178 199 152
134 91 83 97 75 74 92 75 90 78 80 100 116 101 103 97 101 108 101 123
106 97 98 83 73 97 117 118 111 130 123 101 122 89 102 96 85 101 80 96
101 113 106 112 82 83 130 107 129 117 81 110 116 110 117 117 114 99 119 152

SBR-N24B 80

172 115 100 108 106 129 168 156 183 197 195 147 128 96 113 135 158 177 198 156

125 95 84 104 68 84 83 78 77 75 81 109 110 108 101 100 108 108 110 123
107 101 96 91 62 102 118 120 115 131 125 103 120 95 102 99 89 102 83 97
102 111 112 112 82 86 129 110 133 98 83 113 112 119 117 116 103 96 113 150

SBR-N25A 59

431 500 438 438 329 295 340 248 158 204 217 267 181 226 332 232 244 180 143 178
158 164 206 195 245 248 161 175 195 239 195 142 129 149 187 210 159 185 150 131
98 96 81 80 97 106 81 72 66 70 78 86 61 72 86 104 88 79 104

SBR-N25B 59

433 501 442 441 325 298 342 236 162 199 222 263 184 222 341 239 229 180 157 176
159 158 202 205 265 247 160 174 198 234 201 138 128 159 188 211 165 186 155 127
100 90 90 91 109 100 77 74 58 78 79 79 69 73 88 103 84 76 102

SBR-N26A 94

282 369 258 301 250 235 246 223 253 169 181 199 188 205 186 125 93 127 125 151
152 137 171 162 172 103 144 119 155 218 140 110 128 134 205 119 116 98 89 92
108 122 151 109 119 109 131 100 83 90 103 79 94 135 118 91 73 69 112 137
89 101 86 82 82 87 91 87 77 90 85 62 91 88 92 112 112 167 129 128
101 104 86 130 84 81 90 75 98 118 101 85 70 73

SBR-N26B 94

281 364 258 314 248 233 248 226 251 164 184 190 187 199 184 126 90 130 128 154
151 136 170 156 174 110 151 116 160 209 148 109 126 141 203 116 123 98 87 97
99 125 149 105 117 115 126 100 86 85 98 86 92 137 123 86 81 60 114 138
85 100 86 87 84 84 88 90 78 83 87 63 90 87 92 111 116 154 125 132
97 104 89 127 84 79 90 75 100 116 92 80 71 70

SBR-N27A 62

328 261 309 389 344 255 212 260 308 216 283 226 213 204 224 245 230 185 119 139
207 185 153 148 185 197 112 152 133 148 156 125 131 97 154 139 99 101 119 138
110 75 88 113 138 122 120 92 93 81 107 104 114 134 149 103 63 70 87 106
79 106

SBR-N27B 62

337 263 324 406 343 284 216 261 326 219 290 236 207 213 224 252 228 187 118 141
208 186 154 150 189 187 121 157 137 146 153 126 136 94 166 134 106 93 122 139
111 79 90 110 143 117 122 94 94 90 99 107 122 126 167 101 56 73 88 94
81 99

SBR-N28A 105

180 156 166 152 149 102 101 146 183 218 195 115 101 84 134 175 138 185 191 170
139 117 79 126 104 73 73 84 103 101 102 148 124 53 37 61 76 70 81 68
78 79 76 57 65 57 75 63 82 74 117 95 94 76 61 59 33 49 53 70
59 65 56 48 41 55 44 51 72 65 64 55 80 88 59 48 71 61 64 66
71 58 72 93 106 84 84 86 70 72 73 57 68 74 81 79 49 49 45 54
61 48 54 56 50

SBR-N28B 105

173 155 166 147 146 104 102 144 185 220 191 111 100 77 135 168 140 180 187 173
140 112 80 130 100 78 72 84 102 103 102 156 126 47 41 63 71 74 78 72
80 75 84 55 66 55 74 66 78 74 116 99 92 78 57 62 26 53 49 73
60 65 57 49 38 52 51 47 75 71 58 56 81 86 69 46 72 63 60 68
60 58 75 93 110 83 83 82 76 68 75 57 67 77 80 79 50 51 48 44
57 52 53 53 46

SBR-N29A 86

139 155 126 151 145 115 97 118 145 136 184 138 130 124 131 121 75 156 151 100
109 152 112 88 90 83 115 113 102 74 100 106 97 145 124 112 100 88 101 75
98 89 82 105 100 96 85 106 73 73 65 76 81 53 69 42 62 83 71 51
46 35 49 76 55 23 51 51 38 49 67 63 69 61 59 52 57 70 69 90
79 91 82 100 69 60

SBR-N29B 86

144 156 119 154 126 119 97 125 146 139 185 134 133 129 131 114 93 145 145 101
128 160 110 92 90 83 112 115 107 89 101 110 94 143 123 111 99 88 104 73
94 91 82 104 100 90 91 104 71 73 55 84 84 55 60 47 59 80 80 51
41 38 53 72 47 27 48 46 41 53 62 62 68 61 60 53 55 75 65 96
73 94 86 99 71 59

SBR-N30A 61

371 362 371 368 413 425 309 297 305 283 228 192 197 217 178 228 203 230 223 151
168 119 118 101 77 89 102 110 132 129 88 109 115 136 92 95 103 83 122 95
73 61 47 50 51 51 50 32 15 20 26 52 78 94 135 123 137 124 143 111
98

SBR-N30B 61

293 371 367 368 411 444 306 294 308 287 225 189 189 220 184 210 221 224 239 150
168 123 118 99 79 86 107 106 131 133 86 111 117 133 92 96 101 84 120 98
71 62 48 47 51 56 44 34 14 21 28 53 75 96 136 113 138 129 133 109
104

SBR-N31A 66

217 226 185 175 176 152 225 242 177 174 215 315 171 111 92 94 120 107 134 117
143 96 132 115 99 144 93 101 75 114 142 117 146 131 137 140 97 104 60 91
122 118 112 94 98 120 129 104 145 201 254 235 129 134 136 152 140 144 159 185
216 158 196 174 146 134

SBR-N31B 66

227 219 188 179 177 155 230 260 181 169 229 286 180 122 101 100 109 109 137 139
136 109 114 98 109 159 94 108 88 117 131 129 142 134 146 115 95 103 59 100
122 129 110 89 102 119 119 117 152 193 248 238 132 137 151 153 141 161 158 178
235 161 194 186 136 138

SBR-N32A 66

279 245 180 227 162 260 138 236 183 143 202 277 280 182 180 148 161 170 185 167
250 247 263 199 167 159 59 74 88 95 138 192 195 253 196 183 186 244 232 210
175 140 175 244 263 258 213 195 220 161 135 139 149 230 186 187 199 157 165 195
224 233 211 180 164 119

SBR-N32B 66

262 248 179 222 167 263 132 246 182 142 205 274 283 182 176 152 160 170 186 170
248 251 265 199 166 174 65 73 91 95 139 191 191 256 200 176 186 251 242 203
174 150 169 239 261 259 226 190 215 159 141 144 143 219 184 196 193 158 162 193
217 243 218 175 164 108

SBR-N33A 58

222 392 199 133 239 180 197 167 144 191 198 196 168 184 249 276 181 113 170 231
179 141 139 219 202 166 134 147 157 133 119 113 88 220 112 80 82 85 158 121
164 118 77 90 93 112 129 118 126 116 108 68 93 97 97 79 39 61

SBR-N33B 58

226 392 191 134 253 160 177 174 142 179 214 206 163 179 247 288 188 115 165 248
180 142 136 225 191 183 117 143 153 131 111 120 95 213 114 80 80 85 159 123
140 117 75 89 97 112 129 114 121 117 96 69 94 94 100 79 40 68

SBR-N35A 74

370 316 260 354 348 262 240 275 285 253 366 375 306 447 321 323 260 307 357 126
68 31 57 87 138 142 223 202 267 382 436 322 185 179 230 287 213 169 158 172
193 184 117 104 59 91 137 138 228 248 263 271 329 278 251 236 195 239 190 286
165 85 133 124 86 58 42 51 19 42 61 46 34 43

SBR-N35B 74

371 307 263 346 352 250 242 280 310 237 372 382 300 441 313 327 242 309 365 130
62 29 59 104 142 141 217 204 271 422 437 307 185 175 230 291 218 173 158 168
197 186 110 110 58 97 128 138 237 239 265 270 331 275 256 221 193 225 197 272

173 76 137 130 87 56 40 47 24 38 51 40 39 37

SBR-N36A 84

439 427 540 437 579 460 377 408 406 299 297 264 288 304 220 222 241 221 226 161
171 143 174 168 165 177 188 189 196 163 132 99 111 122 121 165 173 162 162 82
99 97 96 97 75 98 112 90 111 110 84 94 126 92 98 138 111 97 132 125
133 106 115 103 88 86 78 60 61 74 55 46 58 47 47 44 34 51 47 46
55 54 68 47

SBR-N36B 84

501 442 539 445 586 470 382 407 403 301 294 262 292 307 219 222 243 226 217 165
174 148 172 166 166 172 190 200 197 160 122 101 115 124 128 168 163 161 162 86
95 96 91 108 72 104 112 94 114 102 82 86 131 97 94 136 114 97 133 125
129 110 113 101 87 83 81 60 59 73 53 45 60 46 44 43 36 52 44 48
59 53 66 50

SBR-N37A 50

294 353 218 275 178 221 199 292 376 317 228 234 138 257 213 285 328 243 305 265
228 266 274 205 253 304 297 249 331 290 191 133 173 199 79 56 41 63 126 174
166 244 239 250 282 287 325 209 192 207

SBR-N37B 50

308 356 221 272 188 225 213 321 358 284 236 226 151 250 211 282 328 240 313 263
226 247 238 211 253 295 312 249 339 286 193 135 167 195 84 53 43 62 130 174
168 243 237 252 287 285 315 216 188 242

SBR-N38A 125

166 191 162 153 173 178 165 243 287 255 167 193 161 87 58 51 56 79 92 85
165 148 151 214 211 170 133 114 119 135 124 120 99 78 90 80 44 61 44 50
74 95 151 106 166 167 144 149 163 189 82 141 123 191 161 127 191 159 99 79
54 68 28 42 49 50 50 58 81 110 113 108 115 140 184 87 66 63 65 61
50 87 99 106 146 106 89 100 86 70 90 86 85 55 53 59 87 93 68 89
93 94 61 56 64 56 55 55 62 62 58 61 88 82 58 65 74 103 97 79
89 96 63 86 71

SBR-N38B 125

163 192 159 146 172 174 174 244 289 239 158 208 153 80 61 49 50 69 98 86
180 156 157 214 216 144 131 113 121 139 123 111 102 73 87 81 41 63 38 50
78 100 156 120 174 166 143 146 162 191 87 144 116 197 160 131 191 162 97 83
55 68 29 41 53 51 47 54 91 111 120 109 111 136 181 98 63 61 76 60
52 85 105 116 147 117 86 112 75 85 76 97 86 57 57 56 93 90 76 78
107 92 61 60 66 60 58 52 66 66 49 65 89 87 60 66 74 97 100 80
94 102 63 80 83

SBR-N39A 96

514 190 282 72 100 120 159 234 226 260 187 221 220 204 184 128 180 144 237 211
249 187 215 231 211 267 253 277 213 229 214 253 223 206 178 175 106 166 175 197
228 144 150 181 163 216 239 240 198 235 214 183 191 173 172 135 103 84 81 92
99 72 53 71 51 77 101 101 113 124 105 74 98 67 72 61 85 64 63 84
60 56 67 46 60 46 52 49 34 45 37 32 49 49 34 17

SBR-N39B 96

496 198 279 73 94 120 173 225 228 252 184 218 217 204 186 128 182 151 239 203
242 197 204 234 206 270 246 283 211 232 212 254 224 201 181 175 144 168 176 191
234 137 154 179 169 214 238 238 198 239 206 187 194 174 174 130 101 89 79 97
95 70 59 78 50 73 103 98 112 118 107 83 95 69 65 64 81 68 63 81
61 53 67 54 56 46 54 54 34 38 37 36 46 50 31 24

SBR-N40A 69

231 231 263 239 177 143 153 190 160 140 155 153 147 190 183 199 142 132 169 144
158 159 127 74 89 112 131 126 260 307 284 219 217 239 236 207 157 191 223 232
221 152 135 101 121 117 111 107 153 151 199 235 230 205 165 160 106 134 121 123

156 147 162 162 139 151 161 147 127

SBR-N40B 69

242 220 268 245 175 143 154 186 159 140 157 151 151 188 183 196 142 132 167 143
157 154 133 70 94 108 132 130 257 307 282 211 222 236 236 200 161 183 226 221
226 154 132 107 116 126 111 108 159 155 201 231 229 199 168 163 99 129 125 143
154 145 163 159 132 155 159 152 126

SBR-N41A 62

176 198 262 296 280 242 185 171 245 257 201 212 283 271 192 166 179 154 149 177
154 103 83 89 110 141 179 158 164 158 189 196 245 235 134 162 168 151 143 119
89 128 101 120 166 129 95 119 101 118 136 87 68 39 87 55 54 69 67 59
59 54

SBR-N41B 62

167 194 264 297 281 244 187 169 252 258 194 216 281 277 194 168 179 155 145 176
152 113 84 88 107 143 175 158 163 167 196 206 248 231 161 167 169 151 144 114
102 116 98 132 162 128 94 125 96 128 134 89 63 52 88 60 53 54 75 56
58 58

SBR-N42A 69

327 328 319 241 212 343 236 222 357 250 140 236 209 245 139 196 252 255 217 181
130 92 83 118 179 147 169 182 144 152 145 132 132 112 115 124 130 137 148 113
76 91 108 107 133 108 97 99 106 92 86 89 105 98 52 58 70 101 95 79
86 61 58 90 108 99 91 101 95

SBR-N42B 69

336 330 319 239 213 346 237 219 354 243 137 237 218 245 139 198 258 253 248 175
134 83 85 114 182 139 179 176 151 145 140 137 130 113 121 122 120 159 146 112
80 88 108 100 145 109 91 106 100 100 87 101 107 90 50 66 69 111 94 79
82 69 48 87 108 112 87 105 91

SBR-N43A 105

73 113 103 145 104 141 196 134 124 116 198 149 118 118 155 169 238 203 179 161
89 124 98 115 184 118 113 104 72 115 81 115 101 71 70 80 65 50 87 64
54 57 58 60 92 108 123 109 87 83 69 54 58 57 69 74 59 79 60 56
60 67 57 45 50 61 80 62 51 41 38 37 39 31 26 26 35 58 48 51
45 70 56 59 53 73 82 60 93 63 124 91 74 75 95 67 57 50 35 22
39 31 49 52 52

SBR-N43B 105

69 120 106 140 117 145 194 144 119 114 207 160 118 121 158 169 242 211 180 167
93 123 103 118 181 122 107 105 74 111 81 119 96 74 74 79 68 58 84 57
58 60 54 60 88 99 133 116 88 84 72 59 54 56 69 80 66 80 60 48
64 67 51 51 55 64 71 60 56 39 40 41 43 29 33 29 36 50 49 49
56 61 58 58 59 65 82 65 98 55 123 92 75 78 104 66 57 53 35 21
33 35 50 49 54

SBR-N44A 62

319 305 315 291 262 269 307 267 354 341 273 222 177 200 263 268 280 285 237 225
195 171 159 201 150 170 150 174 167 120 110 140 147 122 128 101 129 148 95 73
94 114 100 100 112 131 110 111 133 100 76 130 111 159 162 151 121 105 87 100
84 110

SBR-N44B 62

348 312 314 283 263 263 307 276 351 341 263 226 166 191 252 269 279 286 226 233
196 169 162 200 146 171 149 174 166 120 113 143 147 125 134 91 132 148 92 74
89 117 104 95 117 126 113 112 131 96 81 90 125 157 172 152 107 109 76 107
84 112

SBR-N45A 77

184 243 210 177 167 151 107 134 138 231 215 204 167 133 152 124 143 128 143 132
124 148 177 195 148 113 115 113 118 107 98 123 146 140 132 127 149 117 143 84

67 85 144 118 120 162 110 103 122 160 132 123 147 120 106 97 153 154 125 96
109 93 117 106 88 74 77 77 72 87 69 90 79 118 151 107 112

SBR-N45B 77

203 235 211 170 170 153 110 131 138 240 216 203 161 136 155 121 134 123 139 135
125 159 167 197 142 113 111 123 111 109 107 109 153 145 133 124 143 127 133 74
80 83 148 121 117 160 110 106 112 162 132 127 145 115 106 92 153 164 117 95
108 96 114 111 80 79 67 82 70 89 70 88 81 114 148 112 109

SBR-N47A 58

484 457 375 332 262 276 320 201 279 241 232 245 244 285 176 239 221 279 196 170
158 168 86 134 186 139 156 141 120 132 123 103 121 97 128 101 103 102 116 116
142 131 134 116 95 92 85 103 99 92 87 118 99 113 88 58 86 100

SBR-N47B 58

489 444 370 327 261 280 313 205 271 247 238 242 247 269 176 241 218 286 192 155
153 168 85 136 186 138 151 138 126 135 117 105 123 91 135 102 100 107 109 121
129 138 128 116 95 86 94 94 99 91 90 117 99 117 81 58 90 101

SBR-N48A 91

148 187 197 251 230 168 158 108 83 141 173 174 173 152 160 148 150 132 130 122
138 84 106 126 121 173 161 156 125 148 112 103 107 116 123 125 92 145 128 130
88 55 96 100 127 94 82 73 71 87 112 80 141 150 94 100 109 130 119 95
84 99 99 78 82 69 65 46 63 55 79 74 50 84 106 103 110 75 76 98
78 92 68 69 82 82 123 122 142 79 81

SBR-N48B 91

152 181 197 260 223 167 163 121 73 135 176 172 172 153 153 154 153 129 132 116
132 92 105 126 123 175 163 150 124 146 113 105 105 118 120 127 93 143 130 132
91 55 95 106 128 96 81 74 69 88 113 80 143 146 94 102 110 125 124 94
85 98 97 78 77 67 66 47 64 58 71 76 52 81 114 99 111 72 82 98
77 92 64 66 79 83 120 126 140 83 74

SBR-N49A 73

419 490 440 595 478 406 492 306 201 354 327 311 296 269 235 279 204 263 217 171
154 90 160 178 186 186 166 182 210 122 93 91 101 186 212 198 196 168 217 177
186 212 198 227 202 196 182 172 133 186 156 181 146 171 146 115 137 139 154 136
139 144 121 123 126 111 83 110 125 143 117 50 60

SBR-N49B 73

413 503 445 617 460 417 492 303 204 354 329 323 301 263 239 276 205 269 220 169
154 92 160 179 187 186 165 185 220 122 87 81 98 178 216 199 191 171 217 179
186 209 201 229 205 198 179 170 143 186 158 184 145 172 146 114 131 146 150 134
135 156 107 128 120 113 85 111 126 144 114 53 62

SBR-N50A 51

235 184 162 367 280 293 312 258 276 240 231 211 167 200 347 288 211 157 128 118
127 127 95 76 103 91 100 123 128 79 95 102 103 113 142 141 193 120 167 133
129 179 164 130 169 174 150 96 61 115 78

SBR-N50B 51

232 193 158 367 278 292 303 257 283 234 234 226 175 218 350 294 211 161 127 117
130 127 94 77 97 97 98 127 123 88 98 99 91 109 150 139 203 116 174 136
135 187 164 121 167 181 150 106 51 112 71

SBR-N51A 114

114 108 89 105 92 80 99 97 83 80 78 86 83 82 62 89 78 86 69 89
75 114 70 58 55 62 50 53 43 50 57 55 73 73 57 49 43 36 52 69
67 68 69 78 71 61 51 57 67 85 115 96 100 113 85 93 59 79 68 56
61 48 49 49 61 51 74 62 89 85 75 73 50 82 77 44 49 65 60 57
62 41 67 63 89 80 79 82 97 85 99 103 116 111 113 93 86 84 84 80
91 75 96 68 54 62 50 43 62 35 40 45 46 51

SBR-N51B 114

112 108 96 99 88 90 91 100 78 90 72 94 77 85 60 88 78 85 73 84
76 109 72 54 57 65 47 55 45 49 54 59 70 77 55 48 42 37 55 67
70 70 68 79 68 64 57 49 63 85 117 91 103 117 87 90 59 75 62 65
60 45 54 49 58 52 72 67 83 88 76 67 52 82 74 41 52 68 59 53
60 45 66 68 84 83 82 72 96 88 102 97 117 116 115 91 86 83 86 81
92 74 93 72 53 63 50 47 54 40 43 41 48 50

SBR-N52A 79

119 101 146 142 155 161 190 128 116 88 119 122 89 55 38 81 70 60 70 82
59 63 58 63 46 57 66 61 59 77 63 70 64 53 73 62 68 76 85 105
81 84 85 65 53 59 55 64 69 50 58 67 63 66 74 51 42 59 49 52
42 47 63 50 43 54 56 64 64 47 58 37 46 63 77 58 34 62 65

SBR-N52B 79

126 95 151 143 157 162 184 137 123 93 132 130 86 57 38 85 61 65 80 77
66 65 55 57 49 60 58 59 52 83 71 69 65 51 70 60 73 71 94 103
93 83 86 68 52 60 59 65 66 49 60 61 71 61 76 60 33 60 52 49
34 49 68 39 43 56 56 69 65 48 60 41 53 57 80 55 32 62 70

SBR-N53A 84

112 131 153 135 119 110 102 103 93 89 77 84 99 103 77 89 89 121 100 94
113 86 87 107 141 109 87 129 129 124 146 143 118 135 116 135 104 109 114 126
104 113 105 63 83 86 98 73 68 91 107 133 151 151 144 130 147 163 128 106
105 79 90 75 87 92 62 52 64 55 64 59 75 56 42 58 61 90 105 75
61 83 93 154

SBR-N53B 84

119 135 152 134 114 113 105 103 103 78 85 76 107 93 84 78 96 118 103 94
106 101 78 109 139 103 96 127 124 125 149 139 116 134 122 139 105 118 106 125
109 107 105 60 85 82 104 71 54 105 120 125 157 145 134 140 151 161 112 100
101 81 91 83 82 99 61 55 64 59 70 52 69 65 41 49 68 85 108 72
66 76 109 140

SBR-N54A 97

181 133 161 160 136 119 110 124 155 125 98 96 121 122 137 104 83 94 107 101
94 125 115 90 96 113 74 104 124 128 143 132 116 118 88 91 129 108 133 107
141 113 130 135 69 89 75 95 82 60 70 87 94 105 101 113 112 111 87 74
78 58 50 61 65 70 60 52 57 66 69 84 64 83 84 64 58 81 120 158
107 90 95 98 119 87 74 64 98 70 113 55 64 62 84 80 77

SBR-N54B 97

184 136 160 168 139 123 126 140 151 117 98 106 117 127 161 114 65 103 98 106
88 132 116 98 99 109 80 92 124 136 144 140 135 114 89 100 126 98 142 119
144 110 135 143 65 95 72 97 73 61 69 85 97 108 95 119 108 109 95 73
72 60 50 58 70 66 63 54 49 68 70 76 68 79 91 57 57 86 122 149
102 92 102 98 111 96 73 76 89 77 92 75 60 66 85 76 96

SBR-N55A 97

164 135 128 119 110 125 183 151 197 161 129 229 145 183 191 187 114 116 107 173
164 136 107 69 89 82 73 71 66 60 61 59 47 47 47 63 45 53 79 87
105 108 61 60 73 66 88 78 88 93 105 113 86 72 79 74 88 68 58 67
78 65 49 55 33 38 37 45 44 30 36 60 50 53 56 55 74 49 46 55
57 41 59 65 48 44 55 64 68 59 70 79 63 70 56 43 55

SBR-N55B 97

166 138 122 121 125 128 177 159 199 169 116 229 152 173 193 179 127 120 112 166
169 142 105 69 87 83 74 74 42 64 72 56 47 38 48 57 47 52 80 86
101 112 66 61 69 68 90 77 87 89 108 110 87 74 82 74 81 72 68 68
76 68 52 51 37 38 37 46 41 32 37 56 46 47 60 52 73 50 44 54
53 45 58 66 50 40 53 65 67 60 66 80 65 67 61 43 51

SBR-N56A 74

78 90 86 60 85 100 103 88 92 63 103 62 39 36 41 56 61 70 153 125
65 50 22 11 26 21 26 22 38 35 36 52 91 92 82 77 51 90 123 192
233 153 173 143 145 180 159 156 246 154 243 178 111 110 177 160 120 140 108 153
129 168 147 136 86 113 117 135 191 192 114 91 118 101

SBR-N56B 74

83 79 93 59 86 103 106 81 93 64 104 63 33 41 42 58 52 78 156 119
72 47 20 11 25 21 27 20 34 33 34 61 75 103 77 82 50 85 128 190
239 162 174 155 143 192 150 178 244 162 234 180 130 107 174 156 116 134 116 162
118 164 148 141 76 113 123 126 193 187 116 91 114 102

SBR-N57A 51

329 255 309 216 243 233 212 166 177 229 247 248 246 164 155 143 74 132 198 199
207 205 145 121 143 133 120 113 143 118 111 117 149 144 142 171 153 158 147 121
142 128 112 128 110 145 125 125 98 58 95

SBR-N57B 51

317 243 290 228 221 213 227 163 171 226 239 256 234 171 147 128 84 130 199 200
197 188 145 122 139 134 112 116 136 105 115 119 146 141 138 167 152 158 141 118
141 124 113 120 115 146 122 121 98 69 90

SBR-N58A 93

172 177 129 128 107 160 129 107 193 190 145 210 117 110 88 106 133 150 118 97
99 121 130 98 99 79 73 85 113 123 128 131 93 110 104 151 117 101 120 105
83 50 52 83 72 63 52 56 70 57 68 60 101 82 64 83 91 123 97 61
118 67 33 31 37 54 54 84 111 99 69 62 29 10 26 34 27 31 42 40
42 46 60 72 66 57 46 85 121 161 148 101 95

SBR-N58B 93

195 170 135 128 117 167 123 110 159 193 157 212 120 111 90 109 121 148 127 96
92 130 128 94 99 83 80 80 112 121 118 131 92 110 106 144 116 102 123 103
85 51 47 81 81 62 53 52 73 62 59 69 113 69 68 81 86 114 104 61
125 68 35 28 33 62 57 78 116 98 70 63 29 9 23 33 37 28 37 49
40 43 56 71 71 48 51 80 118 161 154 90 114

SBR-N59A 99

195 141 173 167 167 138 156 183 213 176 165 150 82 133 143 234 177 204 164 135
153 126 147 156 130 143 121 138 165 165 135 127 98 108 120 136 110 138 135 129
83 106 125 125 135 65 58 77 92 76 76 89 85 119 72 112 83 94 112 70
67 71 90 111 85 80 81 81 97 98 63 76 104 89 72 71 64 82 63 63
102 89 100 92 81 110 133 125 134 86 92 99 47 75 70 69 73 64 58

SBR-N59B 99

202 136 163 172 178 138 165 189 211 179 158 145 87 127 145 238 182 203 166 140
150 125 153 161 126 125 126 136 173 172 125 131 97 111 115 143 109 133 138 121
85 107 130 125 129 69 60 72 101 69 79 90 93 96 79 111 87 89 105 74
67 62 97 104 87 72 83 80 104 91 70 72 92 90 79 76 59 81 61 68
105 96 97 90 84 108 129 116 142 80 84 99 47 79 75 68 76 57 54

SBR-N60A 82

347 297 299 247 281 324 273 327 347 282 276 394 255 208 211 218 176 250 256 239
193 163 204 184 146 204 161 168 164 141 133 125 144 126 146 126 111 95 110 122
128 146 132 94 117 127 107 73 77 79 116 106 134 141 123 104 137 106 139 122
98 100 110 120 125 128 149 120 146 72 130 139 86 75 150 126 70 75 74 64
93 47

SBR-N60B 82

267 287 311 313 362 421 332 353 434 329 242 278 276 237 319 303 327 250 191 233
215 164 225 183 166 169 142 138 126 155 131 159 133 113 93 105 103 120 145 128
98 92 122 99 81 82 74 116 109 124 128 137 127 111 103 129 128 87 85 101
109 106 95 147 104 119 77 74 95 59 79 129 105 75 70 72 67 79 47 83
71 98

SBR-N61A 87

414 237 209 209 284 276 302 298 307 203 213 262 268 135 125 137 198 292 221 205
214 199 191 185 210 213 248 170 212 261 223 270 219 169 165 145 162 100 63 79
100 184 216 175 155 132 99 96 160 205 203 252 278 249 65 13 39 39 59 69
91 75 59 71 95 54 73 57 80 89 53 105 87 92 106 110 119 106 99 125
113 126 105 83 103 80 57

SBR-N61B 87

425 246 171 220 279 309 335 292 324 215 226 230 251 152 126 156 200 313 222 214
220 223 182 186 210 205 256 178 211 254 227 275 214 149 168 163 162 102 61 81
101 183 223 180 153 128 100 96 163 207 207 257 272 247 65 12 36 39 48 77
85 65 73 73 97 59 64 60 73 89 60 93 86 100 104 111 104 111 107 125
118 143 95 80 89 83 68

SBR-N62A 90

285 219 254 240 236 244 217 227 231 262 255 223 186 193 174 153 195 175 227 224
171 117 109 134 127 127 135 160 136 121 95 110 119 49 58 29 11 25 38 53
60 69 94 93 88 110 116 102 140 147 148 114 153 145 130 172 132 122 131 101
116 92 103 110 93 82 72 94 106 119 72 80 104 93 95 74 90 70 66 71
67 66 70 63 72 68 61 58 83 74

SBR-N62B 90

273 229 250 240 235 246 214 228 235 259 254 224 184 193 169 156 194 163 222 229
169 115 114 129 126 130 137 157 138 120 97 110 116 57 50 27 15 24 39 53
58 75 89 92 93 109 113 105 135 141 135 137 149 146 135 156 142 124 127 103
120 88 108 104 97 85 74 80 117 116 75 82 102 81 97 82 79 70 65 80
71 61 73 65 64 76 53 59 85 73

SBR-N65A 97

29 29 23 39 24 50 51 70 38 56 77 45 137 94 147 144 110 92 74 60
56 58 61 66 95 125 127 109 78 77 66 80 64 69 89 56 58 59 65 68
53 69 86 83 59 53 52 61 43 39 41 53 38 55 54 57 68 69 67 45
64 62 94 30 28 38 27 42 38 28 38 36 39 23 41 34 41 40 29 34
44 40 51 50 58 52 45 61 77 85 55 46 41 31 34 44 45

SBR-N65B 97

30 29 21 36 23 61 45 67 44 56 70 51 134 97 152 143 105 101 70 59
67 41 60 74 89 120 143 83 79 66 74 77 69 74 90 61 48 67 77 60
62 69 78 91 51 56 59 60 44 52 40 58 40 55 48 64 66 59 63 52
58 62 78 24 33 42 29 43 31 28 49 34 36 23 39 44 42 35 30 29
53 45 48 53 57 54 42 68 69 93 54 47 40 33 36 37 54

SBR-N66A 95

79 91 116 81 72 204 98 38 52 18 28 27 58 71 67 47 61 85 54 152
110 129 141 73 54 55 47 53 39 42 62 106 137 92 84 95 110 71 73 74
86 88 62 59 71 73 85 61 86 100 94 78 71 68 54 57 59 50 50 58
72 49 57 73 67 60 41 63 42 68 41 46 55 42 62 55 48 50 42 42
33 51 49 47 44 45 42 51 40 61 61 64 51 36 58

SBR-N66B 95

79 90 123 73 76 203 101 37 53 15 26 28 59 69 70 47 58 91 54 147
109 130 142 67 57 53 46 54 40 42 63 103 139 102 91 90 112 72 72 76
85 84 62 56 67 80 84 61 86 108 95 73 77 63 58 51 61 48 51 54
69 57 56 72 67 61 37 55 50 67 41 47 55 44 58 64 42 49 40 46
34 48 49 51 41 42 50 53 40 59 61 66 52 45 55

SBR-N67A 122

279 220 173 241 250 189 196 216 142 209 193 235 204 132 151 145 152 159 111 161
104 126 149 151 102 80 90 109 127 85 93 121 79 73 72 81 74 112 129 110
103 124 109 144 108 105 99 112 174 143 152 89 89 129 160 81 60 106 113 89
125 89 106 106 77 96 75 110 92 121 109 126 114 121 131 122 131 114 139 145

110 128 109 96 119 95 110 93 105 85 106 124 140 130 130 134 126 145 107 138
156 119 148 130 132 97 72 105 87 114 130 121 132 102 122 97 115 119 105 118
118 113

SBR-N67B 122

183 219 183 238 264 189 187 201 147 200 192 239 208 137 147 144 146 159 115 162
97 128 150 159 93 80 88 109 133 92 90 118 72 68 77 89 83 110 135 111
107 123 105 150 106 107 97 112 177 139 152 92 92 113 167 92 56 96 127 89
119 88 109 107 76 95 80 108 96 129 109 130 103 125 129 126 132 104 142 146
114 129 118 109 112 97 93 101 93 87 109 116 148 132 135 138 124 145 107 134
152 119 155 139 127 97 80 100 89 118 130 117 124 101 136 93 116 107 96 117
114 106

SBR-N70A 119

196 201 228 181 149 157 120 145 149 193 148 104 125 118 113 144 100 149 93 102
176 171 119 81 91 119 130 89 74 144 91 73 104 98 90 96 95 121 105 127
116 134 273 136 105 111 109 96 110 86 112 108 145 78 66 114 121 87 107 120
105 97 77 70 78 107 123 99 121 90 69 104 99 98 110 95 128 145 105 140
138 131 111 115 147 119 153 105 137 147 162 142 142 124 91 133 107 149 149 131
163 128 127 94 89 94 98 106 155 138 140 99 118 80 121 97 87 106 97

SBR-N70B 119

192 199 226 185 140 150 134 147 148 192 148 107 127 116 112 144 104 143 91 114
174 170 121 83 92 120 126 86 83 134 97 77 94 100 88 95 103 128 102 124
122 132 270 144 107 113 114 89 108 86 106 116 138 78 72 110 123 86 106 120
111 102 72 78 71 109 112 112 119 98 69 90 105 95 112 91 121 153 107 131
138 132 106 117 148 115 160 107 129 151 169 143 138 126 92 129 108 151 152 127
160 123 129 88 94 90 98 103 163 126 144 101 117 85 112 105 81 115 94

SBR-N71A 106

107 123 104 108 104 101 90 90 94 80 67 94 64 80 67 88 92 107 100 120
129 103 136 99 93 116 125 98 92 113 124 105 99 88 100 112 133 90 84 116
103 107 70 92 84 97 84 101 89 91 75 90 89 108 97 88 67 83 87 81
85 58 92 80 90 75 89 70 92 74 77 81 92 64 78 79 82 85 65 84
74 46 81 68 87 93 89 77 80 92 78 78 82 77 110 81 75 76 73 63
59 66 69 55 64 48

SBR-N71B 106

129 128 101 105 107 98 96 87 98 74 64 98 62 78 71 94 94 108 103 124
122 107 133 99 89 106 133 97 104 105 125 98 105 94 100 117 134 95 89 111
101 103 72 92 88 100 95 89 83 106 73 88 92 106 97 89 65 88 84 84
78 66 85 79 92 76 84 71 97 75 75 88 90 76 73 62 81 93 66 81
67 44 79 74 98 90 79 86 80 80 83 79 94 84 106 81 82 73 74 64
58 63 70 53 64 54

SBR-N72A 146

105 113 99 105 124 99 113 157 169 136 126 108 134 138 103 117 91 96 103 128
101 86 103 116 99 106 96 95 117 121 94 96 113 102 116 69 100 77 92 101
115 92 102 90 103 94 132 95 98 73 94 81 83 75 60 76 69 82 73 81
65 74 73 71 74 86 62 60 66 70 84 69 77 73 38 66 59 90 90 91
84 91 99 93 68 74 67 89 66 82 68 72 75 59 63 73 62 69 60 57
57 48 46 56 60 68 76 82 75 78 87 64 65 73 66 87 95 82 87 82
70 74 82 78 80 69 81 91 76 95 74 79 91 81 78 62 78 61 79 74
75 75 75 66 85 89

SBR-N72B 146

92 134 97 105 113 106 141 124 168 150 123 101 138 143 100 125 87 91 111 125
106 91 92 127 81 107 87 102 110 123 89 102 110 115 106 79 90 80 87 99
112 91 108 81 110 91 129 97 98 77 82 86 78 85 57 73 75 80 77 82
64 79 64 74 72 92 62 59 61 73 85 72 73 76 46 56 86 75 106 92

91 69 101 89 81 77 75 92 72 79 70 73 68 61 66 69 61 73 56 61
54 46 50 54 63 63 77 81 78 70 83 67 62 83 69 71 98 89 89 80
70 76 80 84 69 77 72 98 81 93 84 81 85 77 66 66 73 69 86 77
69 68 70 79 85 86

SBR-N73A 78

315 316 341 169 165 278 273 387 141 127 152 88 71 170 267 232 262 274 283 166
202 241 249 156 111 167 194 260 119 96 86 104 136 114 129 124 89 125 237 207
275 243 315 227 248 183 234 252 240 243 182 335 231 161 216 170 116 62 49 50
27 78 95 129 125 113 106 96 129 82 80 125 120 107 53 68 81 69

SBR-N73B 78

311 315 341 169 164 282 279 385 143 132 151 88 69 172 265 233 265 275 277 160
198 250 253 155 110 163 192 259 117 94 79 103 125 126 134 127 93 126 238 213
281 228 317 228 251 187 231 246 250 243 182 330 223 159 204 169 116 62 50 46
25 85 92 126 133 116 104 93 131 81 88 121 121 103 55 68 83 56

APPENDIX: TREE-RING DATING

The Principles of Tree-Ring Dating

Tree-ring dating, or dendrochronology as it is known, is discussed in some detail in the Laboratory's Monograph, *An East Midlands Master Tree-Ring Chronology and its uses for dating Vernacular Building* (Laxton and Litton 1988) and *Dendrochronology: Guidelines on Producing and Interpreting Dendrochronological Dates* (English Heritage 1998). Here we will give the bare outlines. Each year an oak tree grows an extra ring on the outside of its trunk and all its branches just inside its bark. The width of this annual ring depends largely on the weather during the growing season, about April to October, and possibly also on the weather during the previous year. Good growing seasons give rise to relatively wide rings, poor ones to very narrow rings and average ones to relatively average ring widths. Since the climate is so variable from year to year, almost random-like, the widths of these rings will also appear random-like in sequence, reflecting the seasons. This is illustrated in Figure A1 where, for example, the widest rings appear at irregular intervals. This is the key to dating by tree rings, or rather, by their widths. Records of the average ring widths for oaks, one for each year for the last 1000 years or more, are available for different areas. These are called master chronologies. Because of the random-like nature of these sequences of widths, there is usually only one position at which a sequence of ring widths from a sample of oak timber with at least 70 rings will match a master. This will date the timber and, in particular, the last ring.

If the bark is still on the sample, as in Figure A1, then the date of the last ring will be the date of felling of the oak from which it was cut. There is much evidence that in medieval times oaks cut down for building purposes were used almost immediately, usually within the year or so (Rackham 1976). Hence if bark is present on several main timbers in a building, none of which appear reused or are later insertions, and if they all have the same date for their last ring, then we can be quite confident that this is the date of construction or soon after. If there is no bark on the sample, then we have to make an estimate of the felling date; how this is done is explained below.

The Practice of Tree-Ring Dating at the Nottingham Tree-Ring Dating Laboratory

I. Inspecting the Building and Sampling the Timbers. Together with a building historian the timbers in a building are inspected to try to ensure that those sampled are not reused or later insertions. Sampling is almost always done by coring into the timber, which has the great advantage that we can sample in situ timbers and those judged best to give the date of construction, or phase of construction if there is more than one in the building. The timbers to be sampled are also inspected to see how many rings they have. We normally look for timbers with at least 70 rings, and preferably more. With fewer rings than this, 50 for example, sequences of widths become difficult to match to a unique

position within a master sequence of ring widths and so are difficult to date (Litton and Zainodin 1991). The cross-section of the rafter shown in Figure A2 has about 120 rings; about 20 of which are sapwood rings – the lighter rings on the outside. Similarly the core has just over 100 rings with a few sapwood rings.

To ensure that we are getting the date of the building as a whole, or the whole of a phase of construction if there is more than one, about 8–10 samples per phase are usually taken. Sometimes we take many more, especially if the construction is complicated. One reason for taking so many samples is that, in general, some will fail to give a date. There may be many reasons why a particular sequence of ring widths from a sample of timber fails to give a date even though others from the same building do. For example, a particular tree may have grown in an odd ecological niche, so odd indeed that the widths of its rings were determined by factors other than the local climate! In such circumstances it will be impossible to date a timber from this tree using the master sequence whose widths, we can assume, were predominantly determined by the local climate at the time.

Sampling is done by coring into the timber with a hollow corer attached to an electric drill and usually from its outer rings inwards towards where the centre of the tree, the pith, is judged to be. An illustration of a core is shown in Figure A2; it is about 150mm long and 10mm diameter. Great care has to be taken to ensure that as few as possible of the outer rings are lost in coring. This can be difficult as these outer rings are often very soft (see below on sapwood). Each sample is given a code which identifies uniquely which timber it comes from, which building it is from and where the building is located. For example, CRO-A06 is the sixth core taken from the first building (A) sampled by the Laboratory in Cropwell Bishop. Where it came from in that building will be shown in the sampling records and drawings. No structural damage is done to any timbers by coring, nor does it weaken them.

During the initial inspection of the building and its timbers the dendrochronologist may come to the conclusion that, as far as can be judged, none of the timbers have sufficient rings in them for dating purposes and may advise against sampling to save further unwarranted expense.

All sampling by the Laboratory is undertaken according to current Health and Safety Standards. The Laboratory's dendrochronologists are insured.



Figure A1: A wedge of oak from a tree felled in 1976. It shows the annual growth rings, one for each year from the innermost ring to the last ring on the outside just inside the bark. The year of each ring can be determined by counting back from the outside ring, which grew in 1976

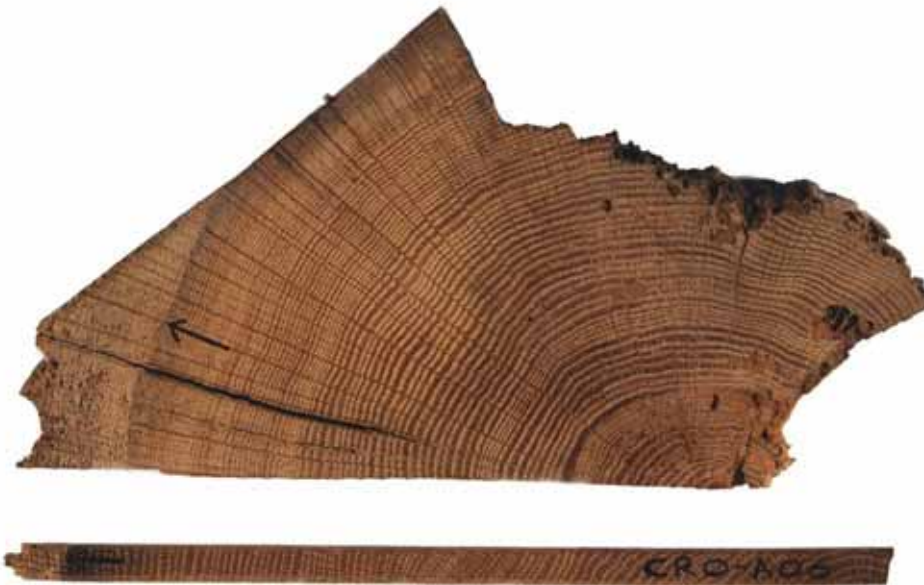

Figure A2: Cross-section of a rafter, showing sapwood rings in the left-hand corner, the arrow points to the heartwood/sapwood boundary (H/S); and a core with sapwood; again the arrow is pointing to the H/S. The core is about the size of a pencil



Figure A3: Measuring ring widths under a microscope. The microscope is fixed while the sample is on a moving platform. The total sequence of widths is measured twice to ensure that an error has not been made. This type of apparatus is needed to process a large number of samples on a regular basis



Figure A4: Three cores from timbers in a building. They come from trees growing at the same time. Notice that, although the sequences of widths look similar, they are not identical. This is typical

2. **Measuring Ring Widths.** Each core is sanded down with a belt sander using medium-grit paper and then finished by hand with flourgrade-grit paper. The rings are then clearly visible and differentiated from each other with a result very much like that shown in Figure A2. The core is then mounted on a movable table below a microscope and the ring-widths measured individually from the innermost ring to the outermost. The widths are automatically recorded in a computer file as they are measured (see Fig A3).

3. **Cross-Matching and Dating the Samples.** Because of the factors besides the local climate which may determine the annual widths of a tree's rings, no two sequences of ring widths from different oaks growing at the same time are exactly alike (Fig A4). Indeed, the sequences may not be exactly alike even when the trees are growing near to each other. Consequently, in the Laboratory we do not attempt to match two sequences of ring widths by eye, or graphically, or by any other subjective method. Instead, it is done objectively (ie statistically) on a computer by a process called cross-matching. The output from the computer tells us the extent of correlation between two sample sequences of widths or, if we are dating, between a sample sequence of widths and the master, at each relative position of one to the other (offsets). The extent of the correlation at an offset is determined by the *t*-value (defined in almost any introductory book on statistics). That offset with the maximum *t*-value among the *t*-values at all the offsets will be the best candidate for dating one sequence relative to the other. If one of these is a master chronology, then this will date the other. Experiments carried out in the past with sequences from oaks of known date suggest that a *t*-value of at least 4.5, and preferably at least 5.0, is usually adequate for the dating to be accepted with reasonable confidence (Laxton and Litton 1988; Laxton *et al* 1988; Howard *et al* 1984–1995).

This is illustrated in Figure A5 with timbers from one of the roofs of Lincoln Cathedral. Here four sequences of ring widths, LIN-C04, 05, 08, and 45, have been cross-matched with each other. The ring widths themselves have been omitted in the bar diagram, as is usual, but the offsets at which they best cross-match each other are shown; eg the sequence of ring widths of C08 matches the sequence of ring widths of C45 best when it is at a position starting 20 rings after the first ring of C45, and similarly for the others. The actual *t*-values between the four at these offsets of best correlations are in the matrix. Thus at the offset of +20 rings, the *t*-value between C45 and C08 is 5.6 and is the maximum found between these two among all the positions of one sequence relative to the other.

It is standard practice in our Laboratory first to cross-match as many as possible of the ring-width sequences of the samples in a building and then to form an average from them. This average is called a site sequence of the building being dated and is illustrated in Figure A5. The fifth bar at the bottom is a site sequence for a roof at Lincoln Cathedral and is constructed from the matching sequences of the four timbers. The site sequence width for each year is the average of the widths in each of the sample sequences which has a width for that year. Thus in Fig A5 if the widths shown are 0.8mm for C45, 0.2mm for C08, 0.7mm for C05, and 0.3mm for C04, then the corresponding width of the site

sequence is the average of these, 0.55mm. The actual sequence of widths of this site sequence is stored on the computer. The reason for creating site sequences is that it is usually easier to date an average sequence of ring widths with a master sequence than it is to date the individual component sample sequences separately.

The straightforward method of cross-matching several sample sequences with each other one at a time is called the 'maximal *t*-value' method. The actual method of cross-matching a group of sequences of ring-widths used in the Laboratory involves grouping and averaging the ring-width sequences and is called the 'Litton-Zainodin Grouping Procedure'. It is a modification of the straightforward method and was successfully developed and tested in the Laboratory and has been published (Litton and Zainodin 1991; Laxton *et al* 1988).

4. **Estimating the Felling Date.** As mentioned above, if the bark is present on a sample, then the date of its last ring is the date of the felling of its tree (or the last full year before felling, if it was felled in the first three months of the following calendar year, before any new growth had started, but this is not too important a consideration in most cases). The actual bark may not be present on a timber in a building, though the dendrochronologist who is sampling can often see from its surface that only the bark is missing. In these cases the date of the last ring is still the date of felling.

Quite often some, though not all, of the original outer rings are missing on a timber. The outer rings on an oak, called sapwood rings, are usually lighter than the inner rings, the heartwood, and so are relatively easy to identify. For example, sapwood can be seen in the corner of the rafter and at the outer end of the core in Figure A2, both indicated by arrows. More importantly for dendrochronology, the sapwood is relatively soft and so liable to insect attack and wear and tear. The builder, therefore, may remove some of the sapwood for precisely these reasons. Nevertheless, if at least some of the sapwood rings are left on a sample, we will know that not too many rings have been lost since felling so that the date of the last ring on the sample is only a few years before the date of the original last ring on the tree, and so to the date of felling.

Various estimates have been made and used for the average number of sapwood rings in mature oak trees (English Heritage 1998). A fairly conservative range is between 15 and 50 and that this holds for 95% of mature oaks. This means, of course, that in a small number of cases there could be fewer than 15 and more than 50 sapwood rings. For example, the core CRO-A06 has only 9 sapwood rings and some have obviously been lost over time – either they were removed originally by the carpenter and/or they rotted away in the building and/or they were lost in the coring. It is not known exactly how many sapwood rings are missing, but using the above range the Laboratory would estimate between a minimum of 6 (= 15-9) and a maximum of 41 (= 50-9). If the last ring of CRO-A06 has been dated to 1500, say, then the estimated felling-date range for the tree from which it came originally would be between 1506 and 1541. The Laboratory uses this estimate for sapwood in areas of England where it has no prior information. It

also uses it when dealing with samples with very many rings, about 120 to the last heartwood ring. But in other areas of England where the Laboratory has accumulated a number of samples with complete sapwood, that is, no sapwood lost since felling, other estimates in place of the conservative range of 15 to 50 are used. In the East Midlands (Laxton *et al* 2001) and the east to the south down to Kent (Pearson 1995) where it has sampled extensively in the past, the Laboratory uses the shorter estimate of 15 to 35 sapwood rings in 95% of mature oaks growing in these parts. Since the sample CRO-A06 comes from a house in Cropwell Bishop in the East Midlands, a better estimate of sapwood rings lost since felling is between a minimum of 6 (=15-9) and 26 (=35-9) and the felling would be estimated to have taken place between 1506 and 1526, a shorter period than before. Oak boards quite often come from the Baltic region and in these cases the 95% confidence limits for sapwood are 9 to 36 (Howard *et al* 1992, 56).

Even more precise estimates of the felling date and range can often be obtained using knowledge of a particular case and information gathered at the time of sampling. For example, at the time of sampling the dendrochronologist may have noted that the timber from which the core of Figure A2 was taken still had complete sapwood but that some of the soft sapwood rings were lost in coring. By measuring into the timber the depth of sapwood lost, say 20mm, a reasonable estimate can be made of the number of sapwood rings lost, say 12 to 15 rings in this case. By adding on 12 to 15 years to the date of the last ring on the sample a good tight estimate for the range of the felling date can be obtained, which is often better than the 15 to 35 years later we would have estimated without this observation. In the example, the felling is now estimated to have taken place between AD 1512 and 1515, which is much more precise than without this extra information.

Even if all the sapwood rings are missing on a sample, but none of the heartwood rings are, then an estimate of the felling-date range is possible by adding on the full complement of, say, 15 to 35 years to the date of the last heartwood ring (called the heartwood/sapwood boundary or transition ring and denoted H/S). Fortunately it is often easy for a trained dendrochronologist to identify this boundary on a timber. If a timber does not have its heartwood/sapwood boundary, then only a *post quem* date for felling is possible.

5. **Estimating the Date of Construction.** There is a considerable body of evidence collected by dendrochronologists over the years that oak timbers used in buildings were not seasoned in medieval or early modern times (English Heritage 1998; Miles 1997, 50–5). Hence, provided that all the samples in a building have estimated felling-date ranges broadly in agreement with each other, so that they appear to have been felled as a group, then this should give an accurate estimate of the period when the structure was built, or soon after (Laxton *et al* 2001, fig 8; 34–5, where ‘associated groups of fellings’ are discussed in detail). However, if there is any evidence of storage before use, or if there is evidence the oak came from abroad (eg Baltic boards), then some allowance has to be made for this.

6. **Master Chronological Sequences.** Ultimately, to date a sequence of ring widths, or a site sequence, we need a master sequence of dated ring widths with which to cross-match it, a Master Chronology. To construct such a sequence we have to start with a sequence of widths whose dates are known and this means beginning with a sequence from an oak tree whose date of felling is known. In Figure A6 such a sequence is SHE-T, which came from a tree in Sherwood Forest which was blown down in a recent gale. After this other sequences which cross-match with it are added and gradually the sequence is 'pushed back in time' as far as the age of samples will allow. This process is illustrated in Figure A6. We have a master chronological sequence of widths for Nottinghamshire and East Midlands oak for each year from AD 882 to 1981. It is described in great detail in Laxton and Litton (1988), but the components it contains are shown here in the form of a bar diagram. As can be seen, it is well replicated in that for each year in this period there are several sample sequences having widths for that year. The master is the average of these. This master can now be used to date oak from this area and from the surrounding areas where the climate is very similar to that in the East Midlands. The Laboratory has also constructed a master for Kent (Laxton and Litton 1989). The method the Laboratory uses to construct a master sequence, such as the East Midlands and Kent, is completely objective and uses the Litton-Zainodin grouping procedure (Laxton *et al* 1988). Other laboratories and individuals have constructed masters for other areas and have made them available. As well as these masters, local (dated) site chronologies can be used to date other buildings from nearby. The Laboratory has hundreds of these site sequences from many parts of England and Wales covering many short periods.

7. **Ring-Width Indices.** Tree-ring dating can be done by cross-matching the ring widths themselves, as described above. However, it is advantageous to modify the widths first. Because different trees grow at different rates and because a young oak grows in a different way from an older oak, irrespective of the climate, the widths are first standardized before any matching between them is attempted. These standard widths are known as ring-width indices and were first used in dendrochronology by Baillie and Pilcher (1973). The exact form they take is explained in this paper and in the appendix of Laxton and Litton (1988) and is illustrated in the graphs in Figure A7. Here ring-widths are plotted vertically, one for each year of growth. In the upper sequence of (a), the generally large early growth after 1810 is very apparent as is the smaller later growth from about 1900 onwards when the tree is maturing. A similar phenomenon can be observed in the lower sequence of (a) starting in 1835. In both the widths are also changing rapidly from year to year. The peaks are the wide rings and the troughs are the narrow rings corresponding to good and poor growing seasons, respectively. The two corresponding sequence of Baillie-Pilcher indices are plotted in (b) where the differences in the immature and mature growths have been removed and only the rapidly changing peaks and troughs remain, that are associated with the common climatic signal. This makes cross-matching easier.

t-value/offset Matrix

	C45	C08	C05	C04
C45		+20	+37	+47
C08	5.6		+17	+27
C05	5.2	10.4		+10
C04	5.9	3.7	5.1	

Bar Diagram

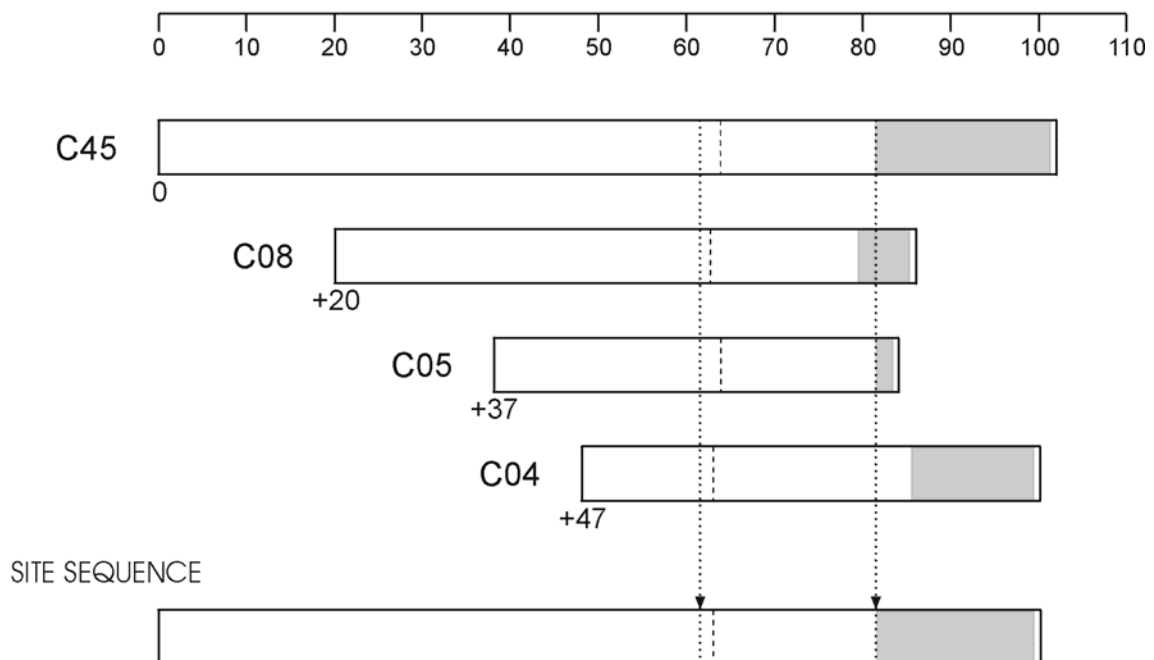

Figure A5: Cross-matching of four sequences from a Lincoln Cathedral roof and the formation of a site sequence from them

The bar diagram represents these sequences without the rings themselves. The length of the bar is proportional to the number of rings in the sequence. Here the four sequences are set at relative positions (offsets) to each other at which they have maximum correlation as measured by the *t*-values. The *t*-value/offset matrix contains the maximum *t*-values below the diagonal and the offsets above it. Thus, the maximum *t*-value between C08 and C45 occurs at the offset of +20 rings and the *t*-value is then 5.6. The site sequence is composed of the average of the corresponding widths, as illustrated with one width.

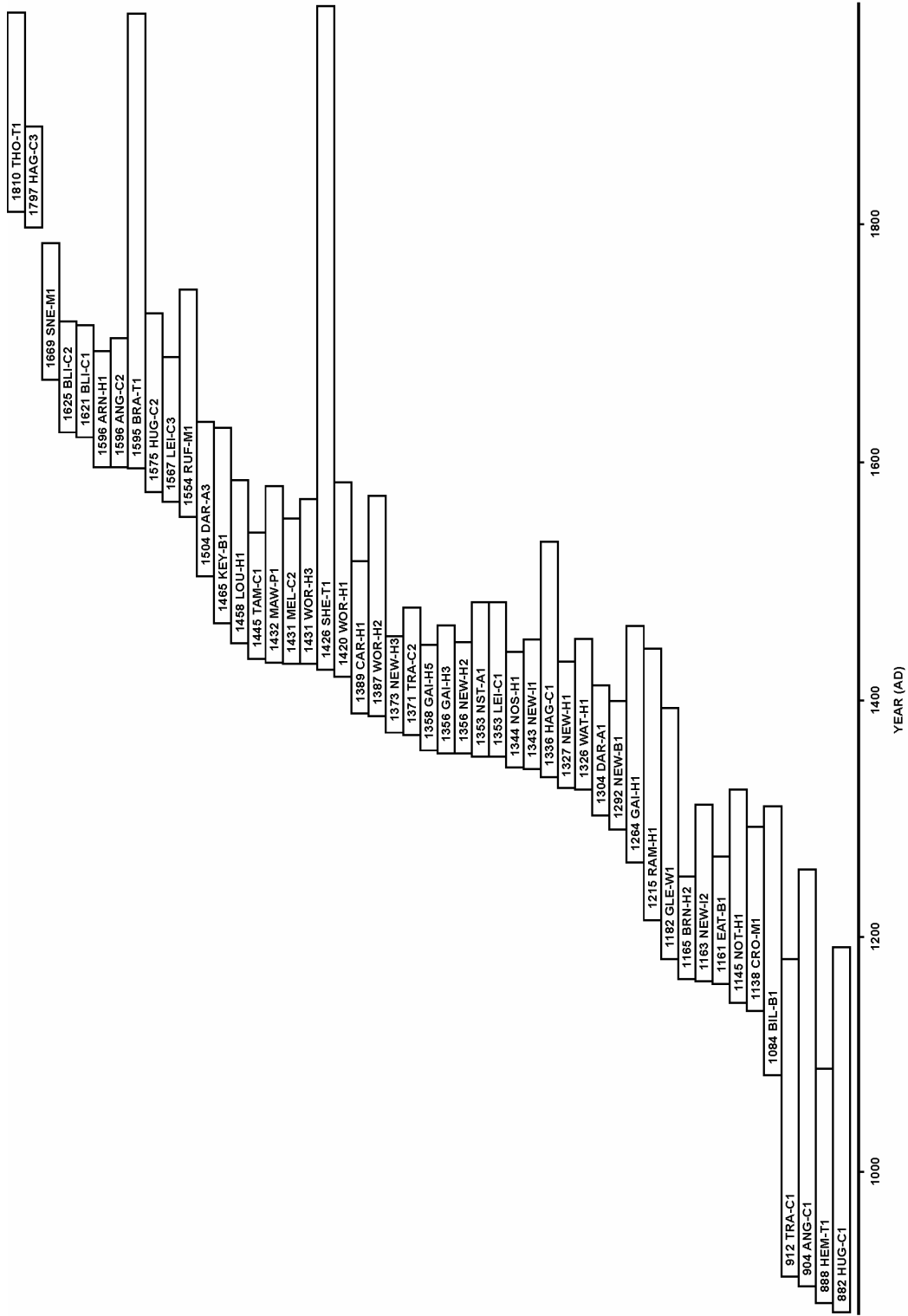
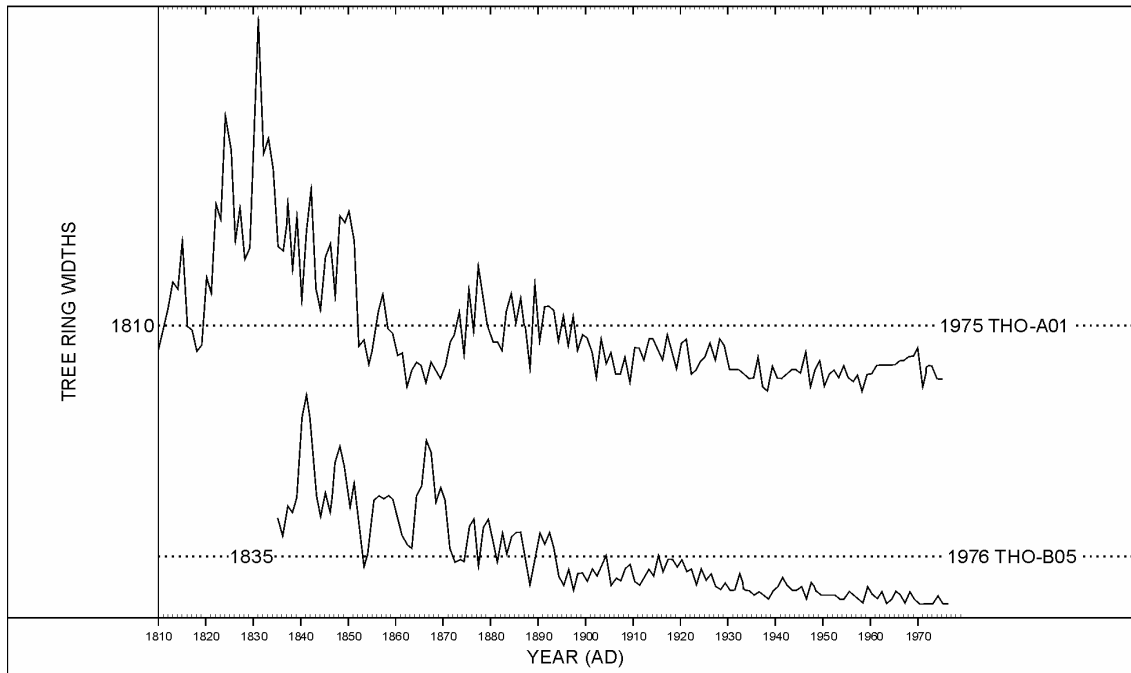

Figure A6: Bar diagram showing the relative positions and dates of the first rings of the component site sequences in the East Midlands Master Dendrochronological Sequence, EM08/87

(a)



(b)

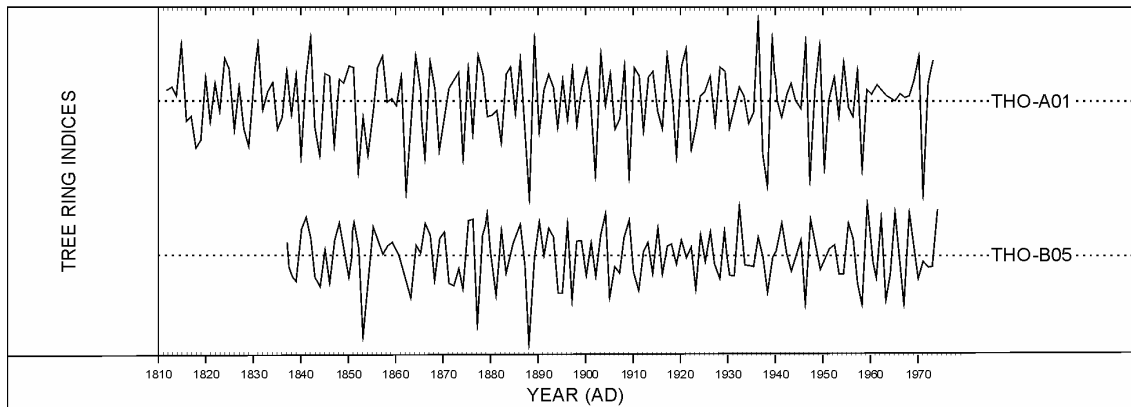

Figure A7 (a): The raw ring-widths of two samples, THO-A01 and THO-B05, whose felling dates are known

Here the ring widths are plotted vertically, one for each year, so that peaks represent wide rings and troughs narrow ones. Notice the growth-trends in each; on average the earlier rings of the young tree are wider than the later ones of the older tree in both sequences

Figure A7 (b): The Baillie-Pilcher indices of the above widths

The growth trends have been removed completely

References

- Baillie, M G L, and Pilcher, J R, 1973 A simple cross-dating program for tree-ring research, *Tree-Ring Bull*, **33**, 7–14
- English Heritage, 1998 *Dendrochronology: Guidelines on Producing and Interpreting Dendrochronological Dates*, London
- Hillam, J, Morgan, R A, and Tyers, I, 1987 *Sapwood estimates and the dating of short ring sequences*, *Applications of tree-ring studies*, BAR Int Ser, **3**, 165–85
- Howard, R E, Laxton, R R, Litton, C D, and Simpson, W G, 1984–95 Nottingham University Tree-Ring Dating Laboratory results, *Vernacular Architect*, **15–26**
- Howard, R E, Laxton, R R, Litton, C D, and Simpson, W G, 1992 List 44 no 17 - Nottingham University Tree-Ring Dating Laboratory: tree-ring dates for buildings in the East Midlands, *Vernacular Architect*, **23**, 51–6
- Hughes, M K, Milson, S J, and Legett, P A, 1981 Sapwood estimates in the interpretation of tree-ring dates, *J Archaeol Sci*, **8**, 381–90
- Laxon, R R, Litton, C D, and Zainodin, H J, 1988 An objective method for forming a master ring-width sequence, *P A C T*, **22**, 25–35
- Laxton, R R, and Litton, C D, 1988 *An East Midlands Master Chronology and its use for dating vernacular buildings*, University of Nottingham, Department of Archaeology Publication, Monograph Series III
- Laxton, R R, and Litton, C D, 1989 Construction of a Kent master dendrochronological sequence for oak, AD 1158 to 1540, *Medieval Archaeol*, **33**, 90–8
- Laxton, R R, Litton, C D, and Howard, R E, 2001 *Timber: Dendrochronology of Roof Timbers at Lincoln Cathedral*, Engl Heritage Res Trans, **7**
- Litton, C D, and Zainodin, H J, 1991 Statistical models of dendrochronology, *J Archaeol Sci*, **18**, 29–40
- Miles, D W H, 1997 The interpretation, presentation and use of tree-ring dates, *Vernacular Architect*, **28**, 40–56
- Pearson, S, 1995 *The Medieval Houses of Kent, an Historical Analysis*, London
- Rackham, O, 1976 *Trees and Woodland in the British Landscape*, London



ENGLISH HERITAGE RESEARCH AND THE HISTORIC ENVIRONMENT

English Heritage undertakes and commissions research into the historic environment, and the issues that affect its condition and survival, in order to provide the understanding necessary for informed policy and decision making, for the protection and sustainable management of the resource, and to promote the widest access, appreciation and enjoyment of our heritage. Much of this work is conceived and implemented in the context of the National Heritage Protection Plan. For more information on the NHPP please go to <http://www.english-heritage.org.uk/professional/protection/national-heritage-protection-plan/>.

The Heritage Protection Department provides English Heritage with this capacity in the fields of building history, archaeology, archaeological science, imaging and visualisation, landscape history, and remote sensing. It brings together four teams with complementary investigative, analytical and technical skills to provide integrated applied research expertise across the range of the historic environment. These are:

- * Intervention and Analysis (including Archaeology Projects, Archives, Environmental Studies, Archaeological Conservation and Technology, and Scientific Dating)
- * Assessment (including Archaeological and Architectural Investigation, the Blue Plaques Team and the Survey of London)
- * Imaging and Visualisation (including Technical Survey, Graphics and Photography)
- * Remote Sensing (including Mapping, Photogrammetry and Geophysics)

The Heritage Protection Department undertakes a wide range of investigative and analytical projects, and provides quality assurance and management support for externally-commissioned research. We aim for innovative work of the highest quality which will set agendas and standards for the historic environment sector. In support of this, and to build capacity and promote best practice in the sector, we also publish guidance and provide advice and training. We support community engagement and build this in to our projects and programmes wherever possible.

We make the results of our work available through the Research Report Series, and through journal publications and monographs. Our newsletter *Research News*, which appears twice a year, aims to keep our partners within and outside English Heritage up-to-date with our projects and activities.

A full list of Research Reports, with abstracts and information on how to obtain copies, may be found on www.english-heritage.org.uk/researchreports

For further information visit www.english-heritage.org.uk

