

*Investigations of the Roman riverside settlement in
Five Acres at Bridge Farm, Wellingham, East Sussex
2014 (CAP.BF14)*

PART 3: THE DRAWN SITE RECORD

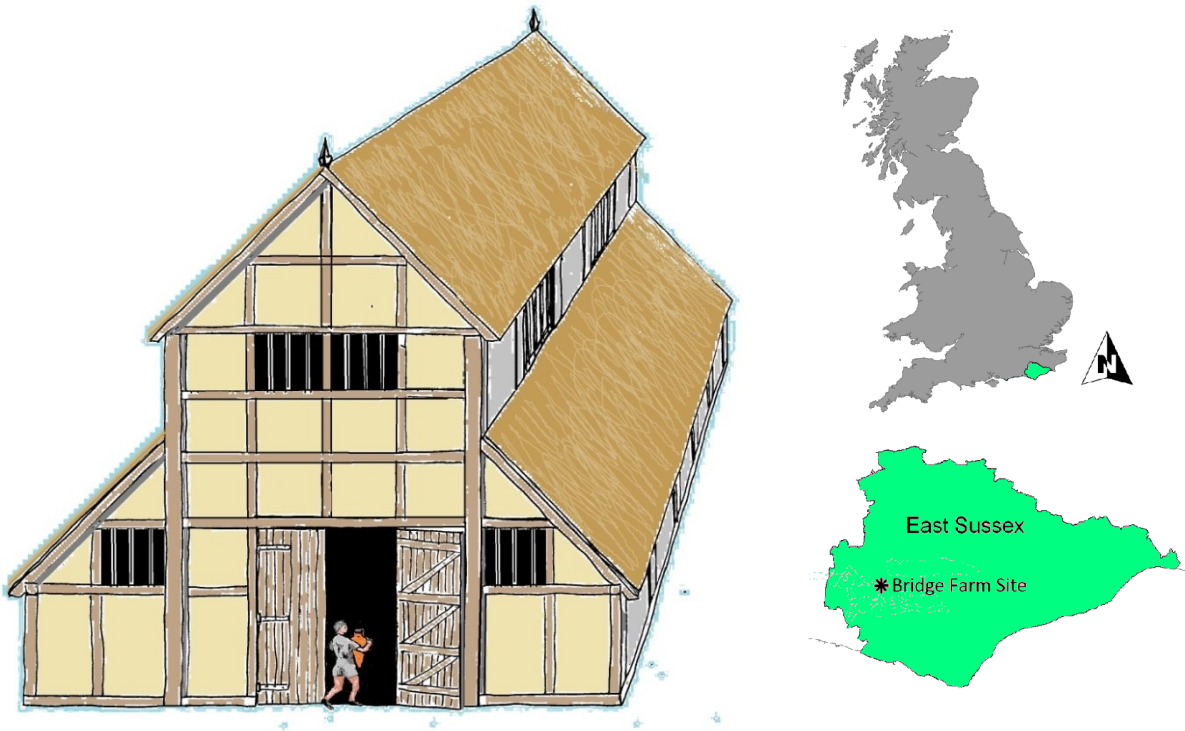

David H Millum, MCifA, MA, BA Hons

©CAP2021



CAP HQ, Bridge Farm, Barcombe Mills Road, Barcombe, East Sussex. BN8 5BX

www.culverproject.co.uk

Directors: Robert Wallace PCIfA, MA, BA Hons & David Millum MCIfA, MA, BA Hons

Email: info@culverproject.co.uk

***Investigations of the Roman riverside settlement in
Five Acres at Bridge Farm, Wellingham, East Sussex
2014 (CAP.BF14)***

PART 3: THE DRAWN SITE RECORD

Report Data

National Grid Reference (NGR): 542970 114565 (TQ42971456)

CAP Project Codes: BRF14 (a.k.a.BF14), DC4

Report Date: 11 January 2021

Report Reference: CAP.BF14

DOI:

Copyright: Culver Archaeological Project ©CAP2021

Prepared in accordance with CAP reporting procedures

Written by David Millum, January 2021

Approved by Robert Wallace, CAP Project Director January 2021

Front cover shows an imaginative reconstruction of the 13 large postholes excavated in 2014 as an aisled warehouse (David Millum 2017)

PART 3: Section 15 The Drawn Site Record (Maps, Geophysical plots and Excavation Plans & Sections)

List of the Drawn Site Record included in this section

15.1	Bridge Farm location maps	3-4
	15.1.1: Modern OS extract showing Bridge Farm in relation to Lewes	3-4
	15.1.2: Google Earth image showing the location of project HQ	3-4
	15.1.3: Map showing the Bridge Farm settlement in context with SE Roman Briton	3-5
	15.1.4: Map showing the Bridge Farm settlement in its immediate Roman context	3-5
15.2	Geophysical survey images	3-6
	15.2.1: Map showing the geophysical surveys undertaken in the surrounding area	3-6
	15.2.2: Geophysical survey image of Bridge Farm showing Trench 5 location	3-6
	15.2.3: Geophysical survey image of Five Acres	3-7
	15.2.4: Geophysical survey image of Trench 5 with 5m grid	3-7
15.3	Overall plans of the excavation trench	3-8
	15.3.1: Basic post-excavation layout plan taken with survey grade GPS	3-8
	15.3.2: Site excavation plan prepared from the 1:20 5m square site plans	3-9
	15.3.3: Site excavation plan overlaid on geophysical survey image	3-10
	15.3.4: Site excavation plan showing phasing	3-11
	15.3.5: Site excavation plan showing context, feature and posthole group numbers	3-12
	15.3.6: Extracts from full site plan showing the posthole Groups	3-13
	15.3.7: Extract from site plan showing two stakehole groups at PH6 & PH13	3-13
	15.3.8: Site excavation plan showing section location and numbers	3-14
15.4	Sections of the Central Ditch F001	3-15
	15.4.1 §10.2 & 4.1 sections of Central Ditch F001 at the NE end where divides in two	3-15
	15.4.2 §10.1 & 22.2 sections of Central Ditch F001 adjacent to hearth F002	3-15
	Location plan for 15.4.1/2	3-15
	15.4.3: §21.4, 8.1 & 2.1 sections of Central Ditch F001 in the SW half of the trench	3-16
	Location plan for 15.4.3	3-16
15.5	Section of the Hearth F002 (Roman Period 4)	3-16
	15.5.1: §13.3, section of the Banjo-shaped hearth F002	3-16
	Location plan for 15.5	3-16
15.6	Sections of the large pit [5272] at the NW baulk, truncated by ditch F003	3-17
	15.6.1: §33.1 section of the pit at the baulk of the NW trench extension c.96.00E	3-17
	15.6.2: §9.1 & 9.2 sections of the pit at the original NW baulk at 97.50E and at 98.30E	3-17
15.7	Sections of the postholes possibly forming a building F011A (Roman period 5)	3-18
	15.7.1: §19.2, 19.4, 21.1, 30.1, 30.2, 30.3 & 31.1 sections of 7 postholes	3-18
	Location plan for F011A postholes	3-18
15.8	Sections of 2 shallow pits (Roman period 5)	3-19
	15.8.1 §8.2 & 12.3 sections of 2 pits adjacent to F010	3-19
	Location plan for 15.8.1	3-19
15.9	Sections of small linier F006 (Roman period not defined)	3-19
	15.9.1 §1.1, 6.1 & 6.2 of possible small ditch F006	3-19
	Location plan for 15.9.1	3-19

15.10	Sections of the posthole/small pit Groups 1, 2 & 3 (Roman periods 5-6)	3-20
	15.10.1 \$3.1, 3.2, 3.4, 5.5 & 5.4 sections of Group 1	3-20
	Location plan for G1 sections	3-20
	15.10.2 \$5.1 section of Group 2	3-20
	Location plan for G2 section \$5.1	3-20
	15.10.3 \$1.2, 2.4, 3.5, 3.6, 5.2, 6.3, 6.5 & 7.4 sections of Group 3	3-21
	Location plan for G3 sections in 5.10.3	3-21
15.11	Sections of the 13 large postholes forming building F004 (Roman period 6)	3-22
	Location plan for F004 postholes	3-22
	15.11.1 PH1 from sections \$15.1, 32.1, 32.2 & 34.1	3-23
	15.11.2 PH2 from sections \$20.1 & 28.1	3-23
	15.11.3 PH3 from sections \$20.2 & 29.1	3-24
	15.11.4 PH4 from sections \$20.3 & 27.2	3-24
	15.11.5 PH5 from sections \$15.3 & 25.1	3-24
	15.11.6 PH6 from sections \$15.2 & 25.3	3-25
	15.11.7 PH7 from section \$26.2	3-25
	15.11.8 PH8 from sections \$23.2 & 18.1	3-25
	15.11.9 PH9 from sections \$18.2, 24.2 & 35.1	3-26
	15.11.10 PH10 from section \$14.4	3-26
	15.11.11 PH11 from section \$24.1	3-26
	15.11.12 PH12 from section \$31.2	3-27
	15.11.13 PH13 from section \$25.2	3-27
15.12	Sections of the posthole group F011B (Roman period 6)	3-27
	15.12.1 Postholes \$19.5, 26.1 & 27.1 and shallow pit \$4.4 plus location plan	3-27
15.13	Sections of the sump well F009 and pit F010 (Roman period 6c)	3-28
	15.13.1: \$17.1 SW/NE sections of sump well F009	3-28
	15.13.2: \$16.1 SE/NW sections of sump well F009	3-28
	15.13.3: \$13.1 SW/NE facing sections of large pit F010	3-29
	15.13.4: \$13.2 SE/NW facing sections of large pit F010	3-29
15.14	Sections of hearth F007 and adjacent stakeholes	3-29
	15.14.1 \$7.1a, 7.1b & 3.3 of the hearth with \$7.2 & 7.3 of the stakeholes	3-29
15.15	Sections of ditches F003 and F008 (Roman period 6c)	3-30
	15.15.1 \$2.2, 8.3 & 28.2 of ditch F003	3-30
	15.15.2 \$11.2 of F003/F008 intesection and sections \$12.1 & 12.2 of ditch F008	3-30
	Location plan for 15.15 ditch section from F003 & F008 and 15.16.1 \$19.6 (see below)	3-31
15.16	Sections of F005 and gully ditch west of F003 (Roman period undefined)	3-31
	15.16.1 \$22.3 section of small gully around the flint surface F005	3-31
	Location plan for \$22.3 of F005	3-31
	15.16.2 \$19.6 section of small linear west of F003 at SW baulk, possibly F006	3-31

15.1 Bridge Farm Location Maps

15.1.1: Modern OS extract showing Bridge Farm in relation to Lewes

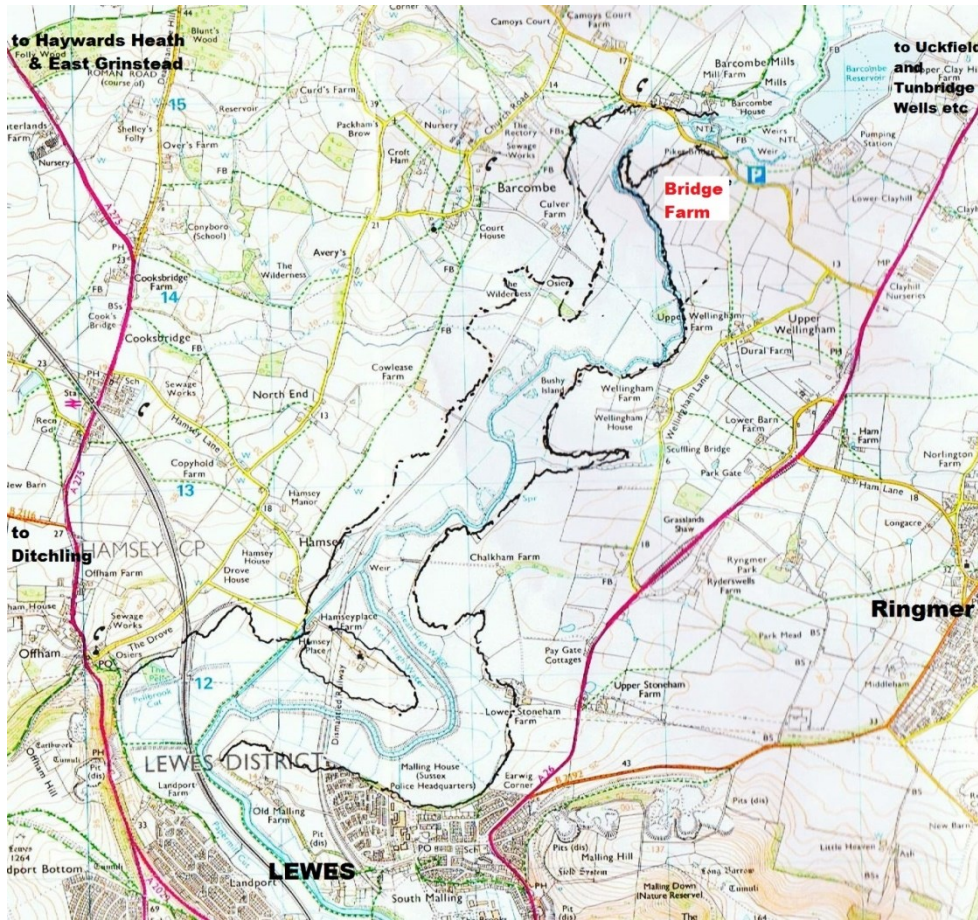

15.1.2: Google Earth image showing the location of project HQ

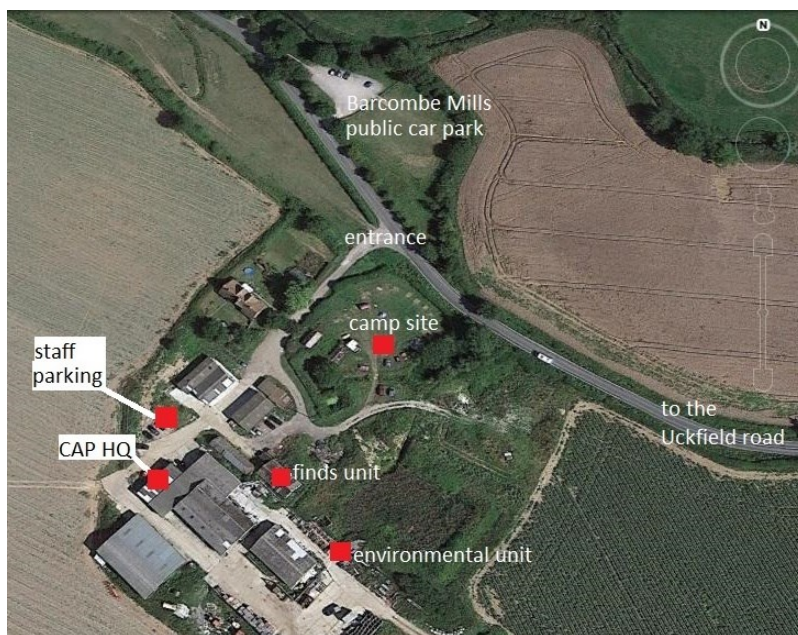

15.1.3: Map produced from the Roman Rural Settlements website showing the Bridge Farm settlement in context with SE Briton during the Roman period

(<http://archaeologydataservice.ac.uk/archives/view/romangl/map.cfm>)

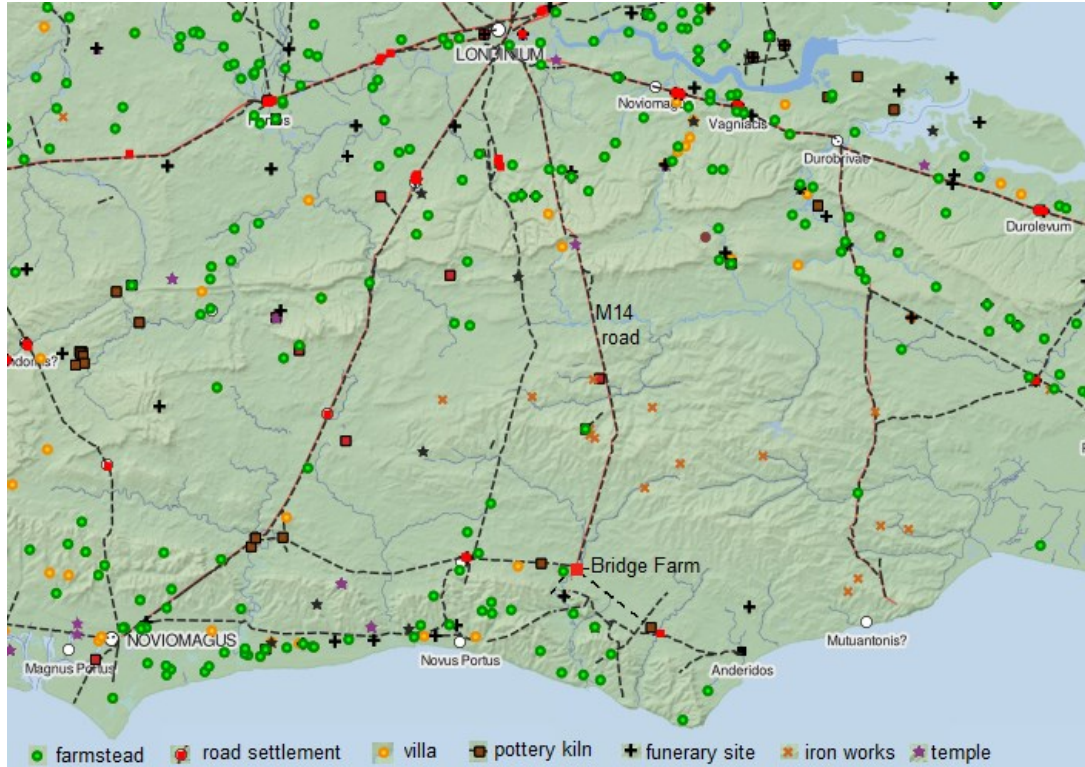

15.1.4: Map showing the Bridge Farm settlement in its immediate Roman context

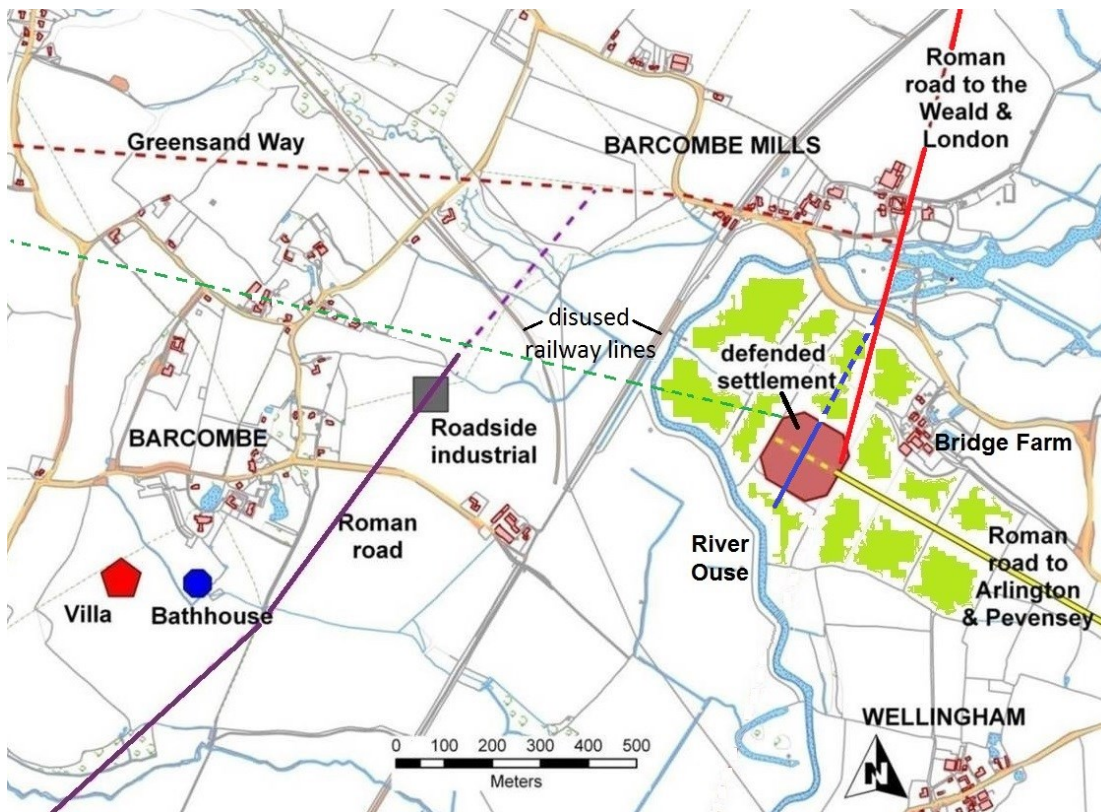

15.2 Geophysical survey images

15.2.1: Map showing the geophysical surveys undertaken in the surrounding area

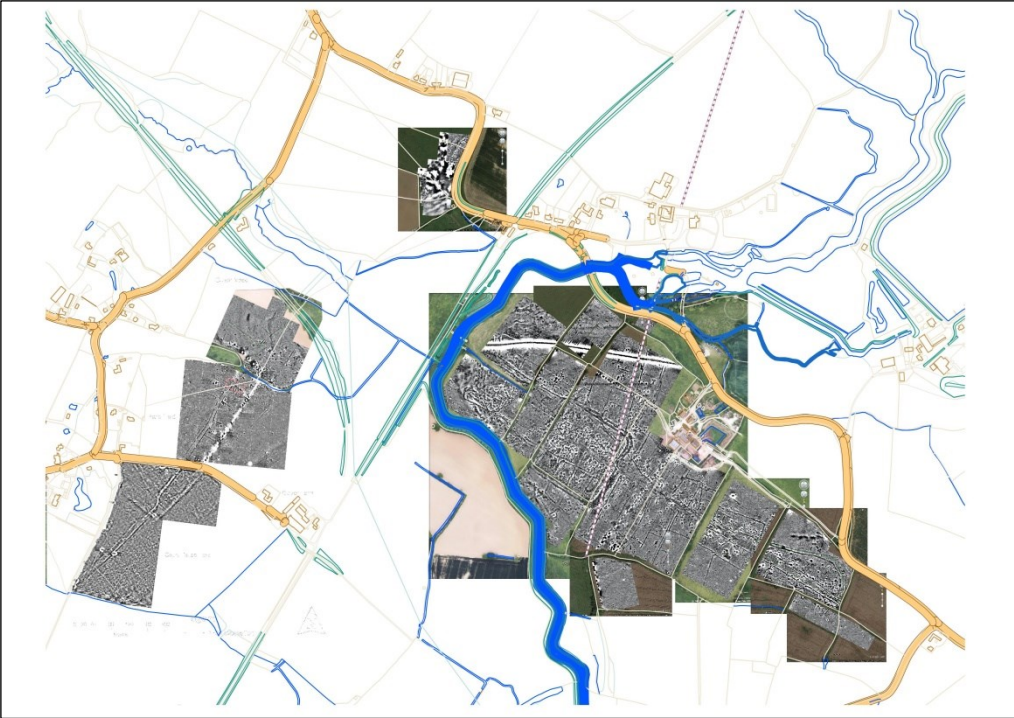

15.2.2: Geophysical survey image of Bridge Farm showing Trench 5 location



15.2.3: Geophysical survey image of Five Acres

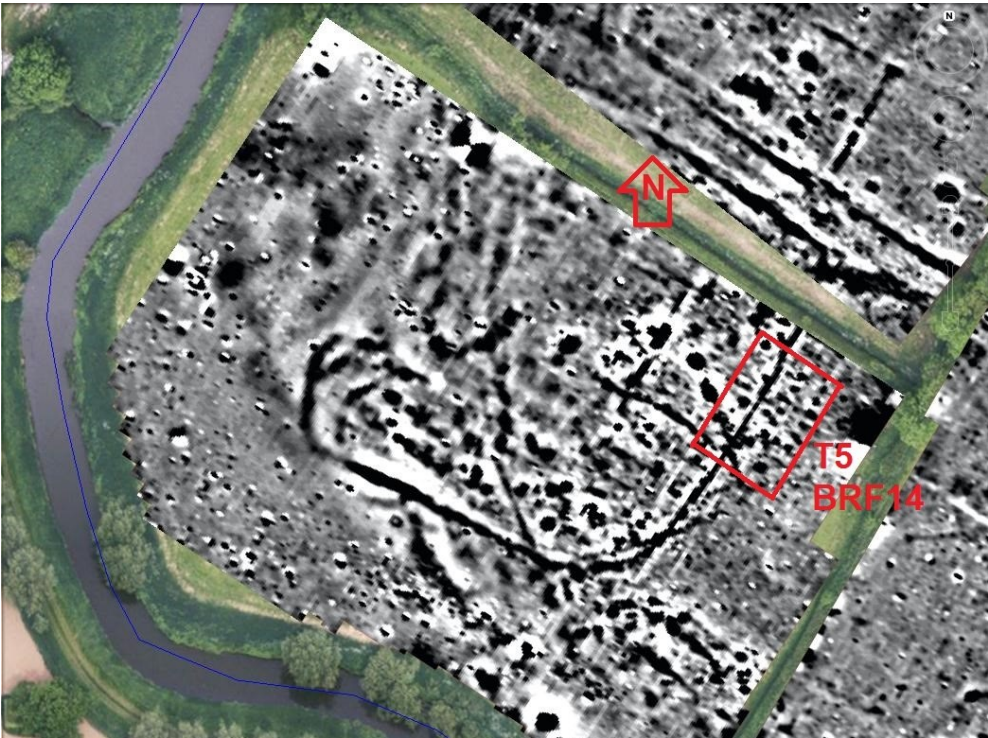

15.2.4: Geophysical survey image of Trench 5 with 5m grid

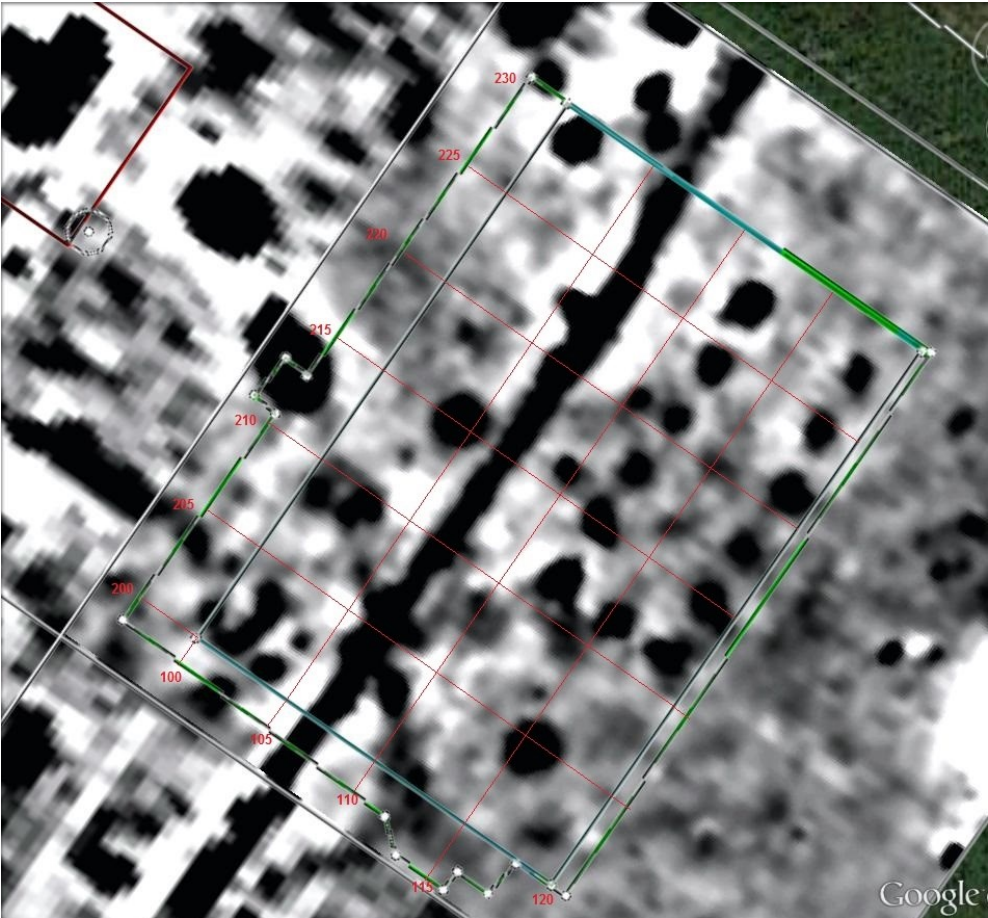

15.3 Overall plans of the excavation trench

15.3.1: Basic post-excavation layout plan taken with survey grade GPS

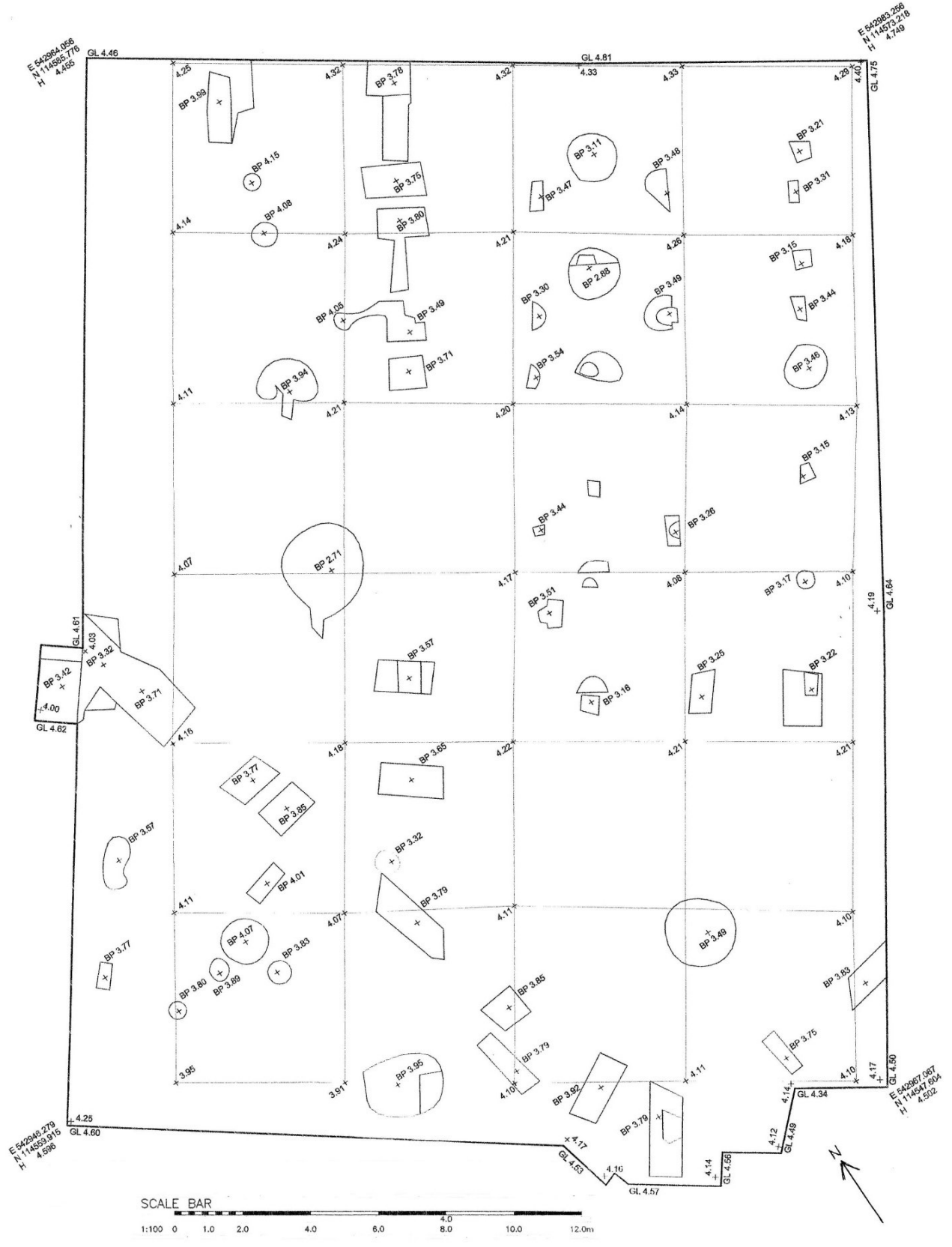

15.3.2: Site excavation plan prepared from the 1:20 scale site plans

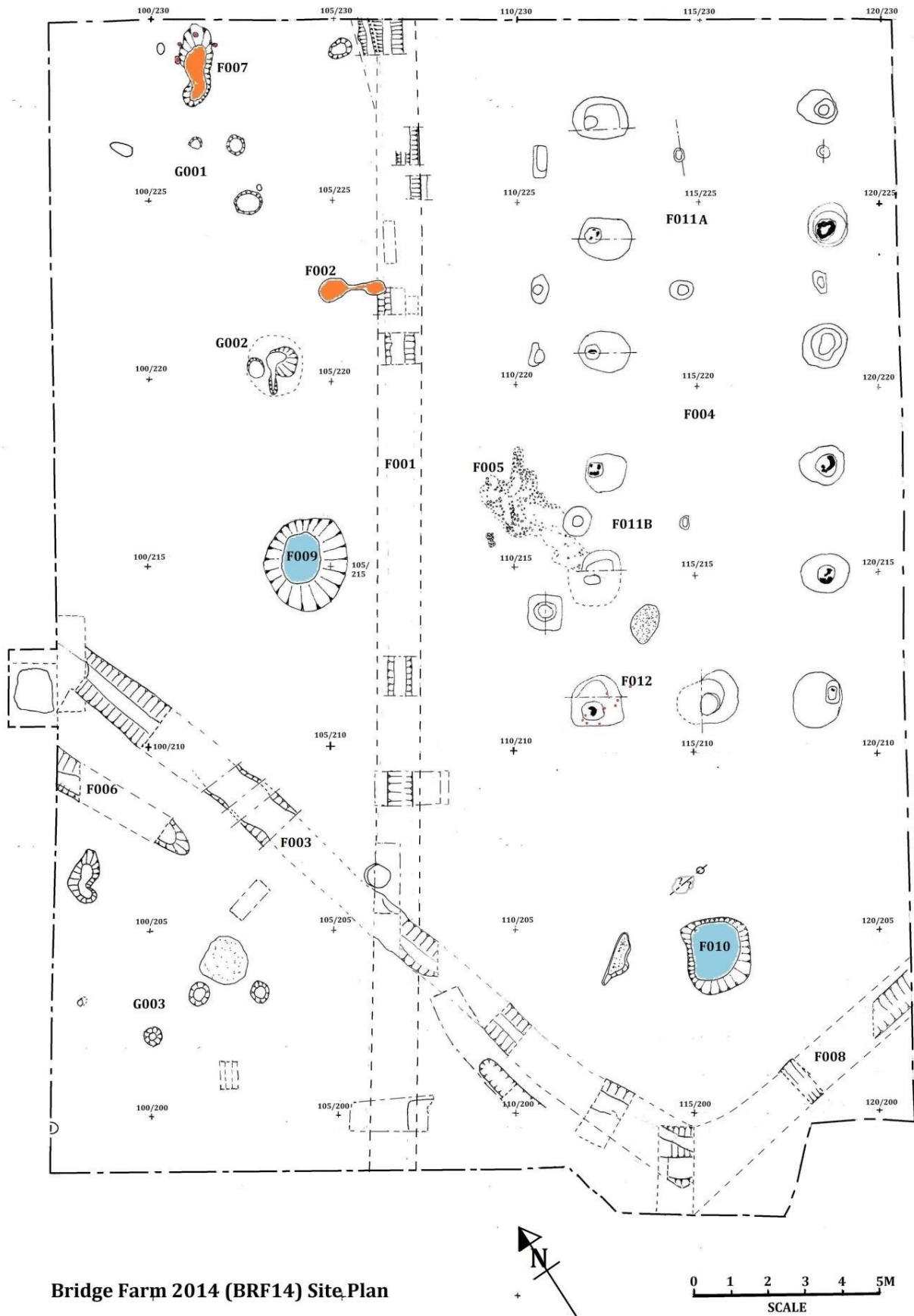

Bridge Farm 2014 (BRF14) Site Plan

15.3.3: Site excavation plan overlaid on geophysical survey image

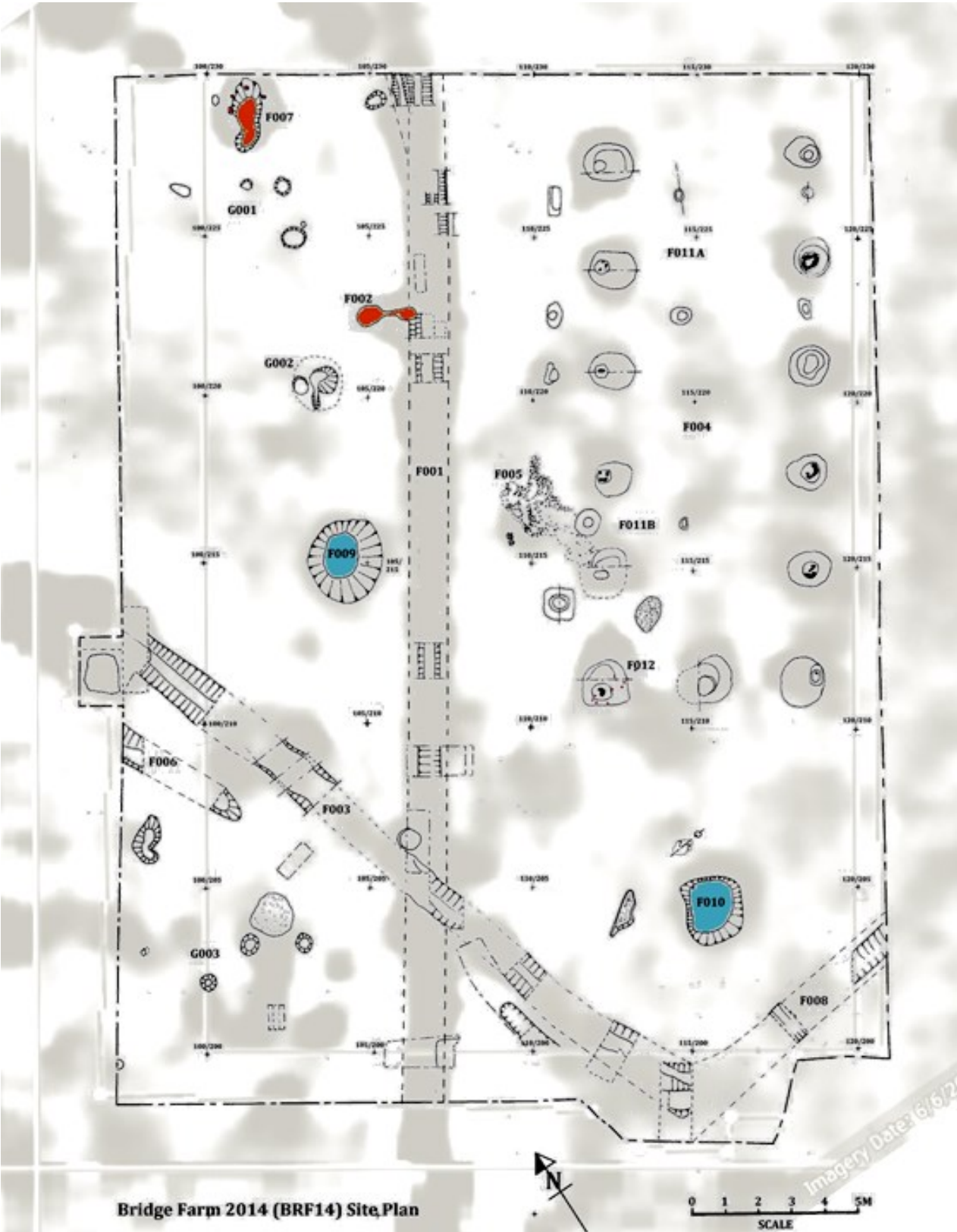

15.3.3: Site excavation plan showing phasing

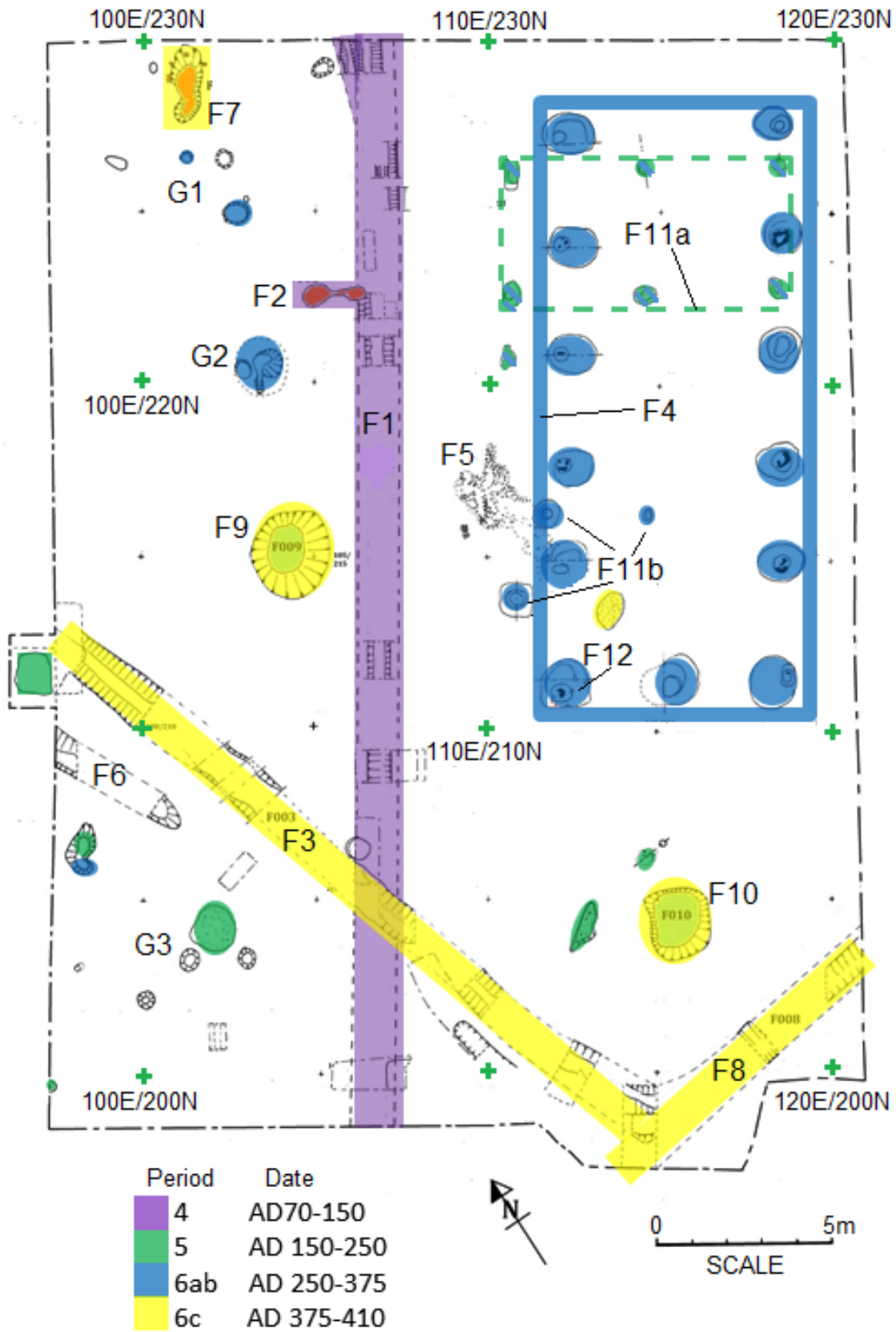

15.3.5: Site excavation plan showing context, feature and posthole group numbers

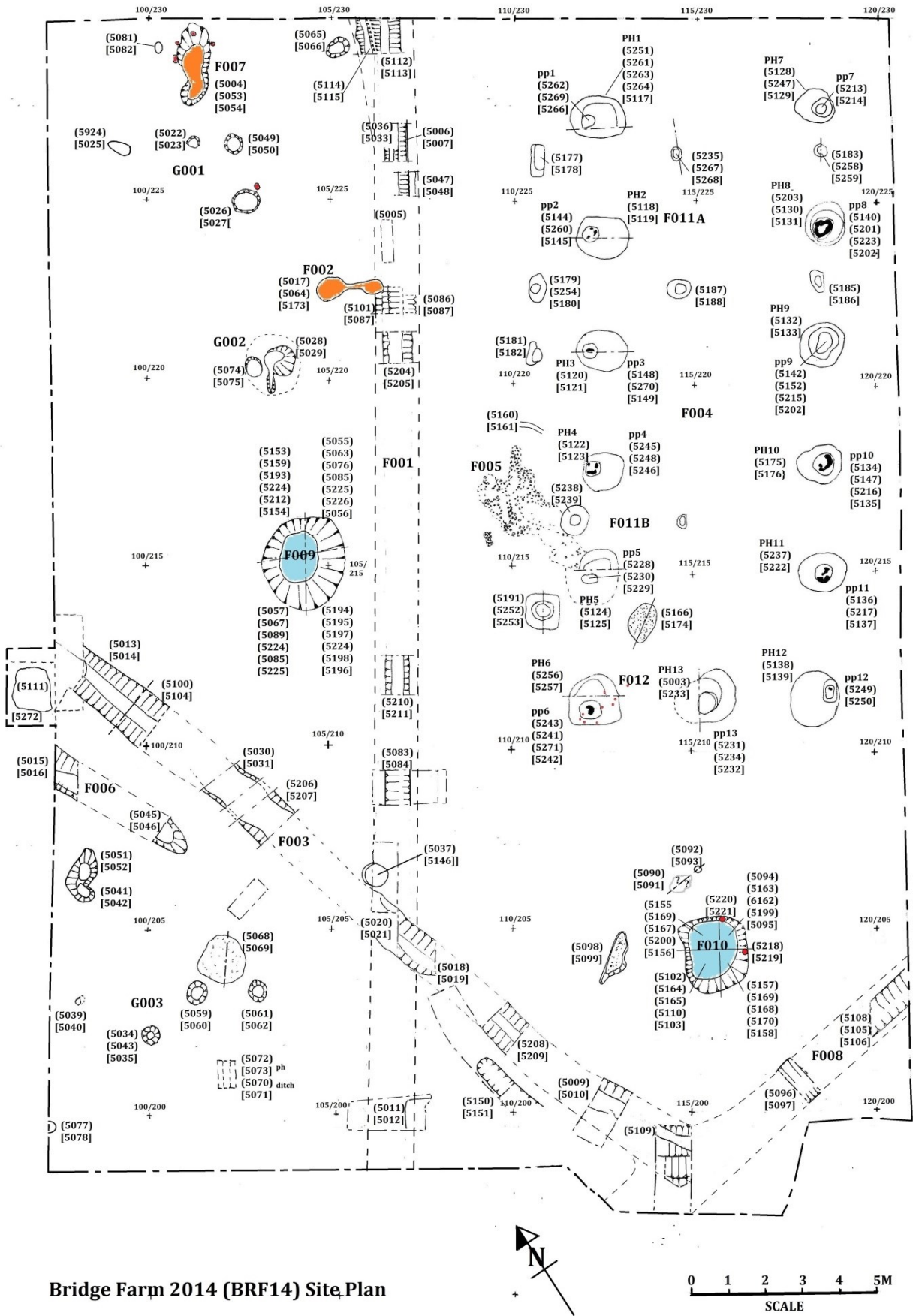

Bridge Farm 2014 (BRF14) Site Plan

15.3.6: Extracts from site plan showing the posthole Groups

These groups of postholes whilst adjacent and in some cases suggesting a structure were not considered definite enough to be granted feature status.

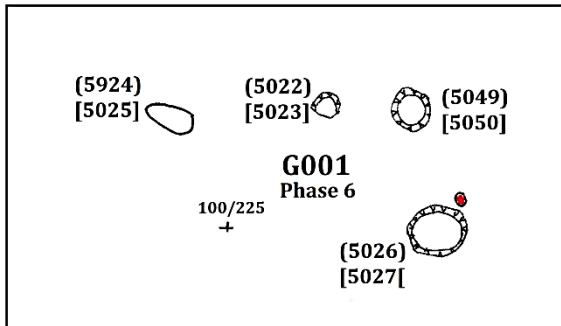

Group 1 - 4 postholes (Phase 6)
just southwest of forging hearth F007

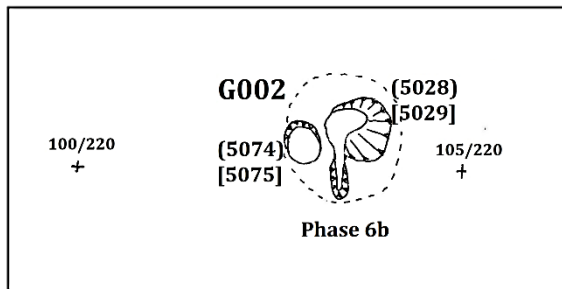

Group 2 - 2 postholes/pits (Phase 6b)
just west of hearth F002

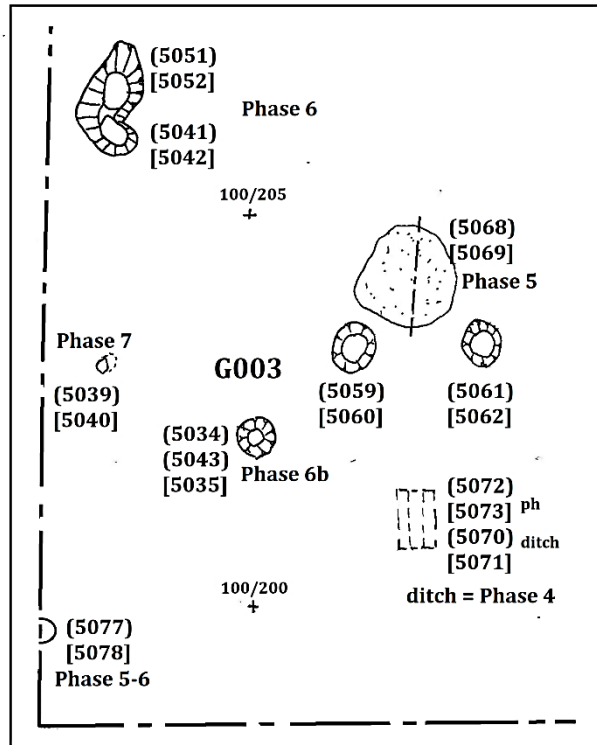

Group 3 - 8 postholes and shallow pit
in the west corner of the trench
Multi phase 4-6

15.3.7: Extract from site plan showing the stakehole groups at PH6 & PH13

The ends of 10 stakeholes (5227 & 5171) were observed on the perimeter and/or cutting through the surface of posthole 6 of building F004 with a further 3 stakeholes on the northern side of posthole 13 recorded on the site plan only; all 13 are shown red in the plan below and marked s/h.

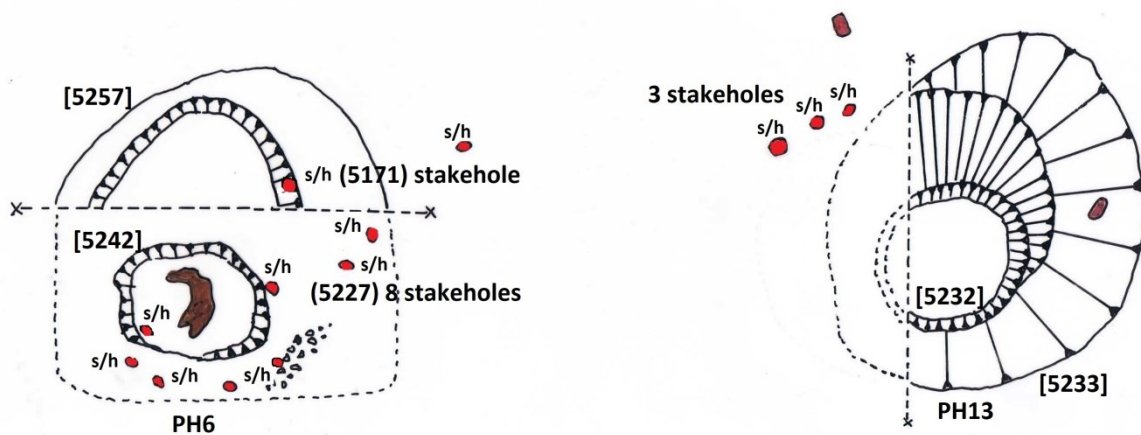

15.3.8: Site excavation plan showing section location and numbers

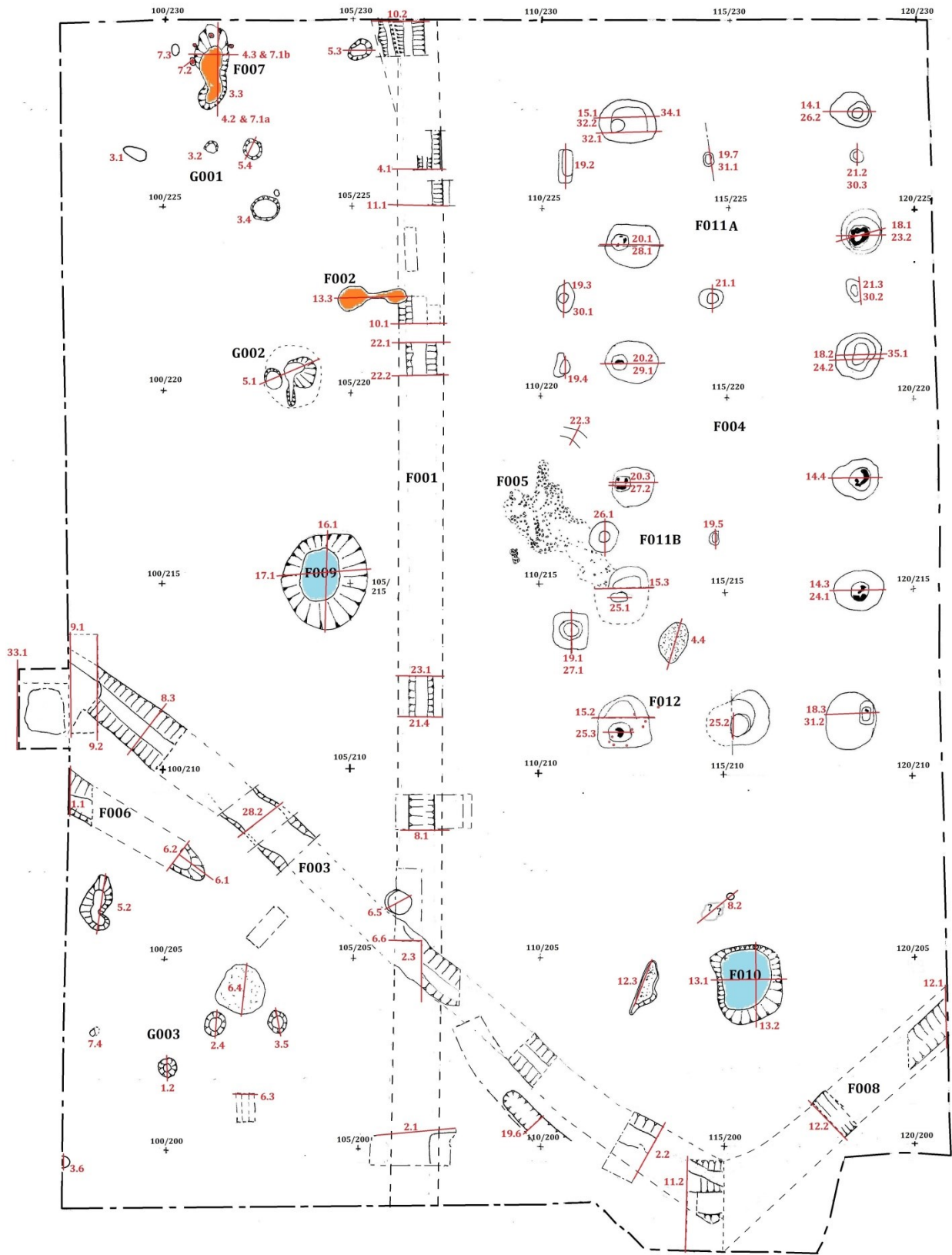

Section location plan
Bridge Farm 2014 (BRF14) Site Plan

15.4 Sections of the Central Ditch F001

15.4.1: \$10.2 & 4.1 sections of Central Ditch F001 at the NE end where it divides in two

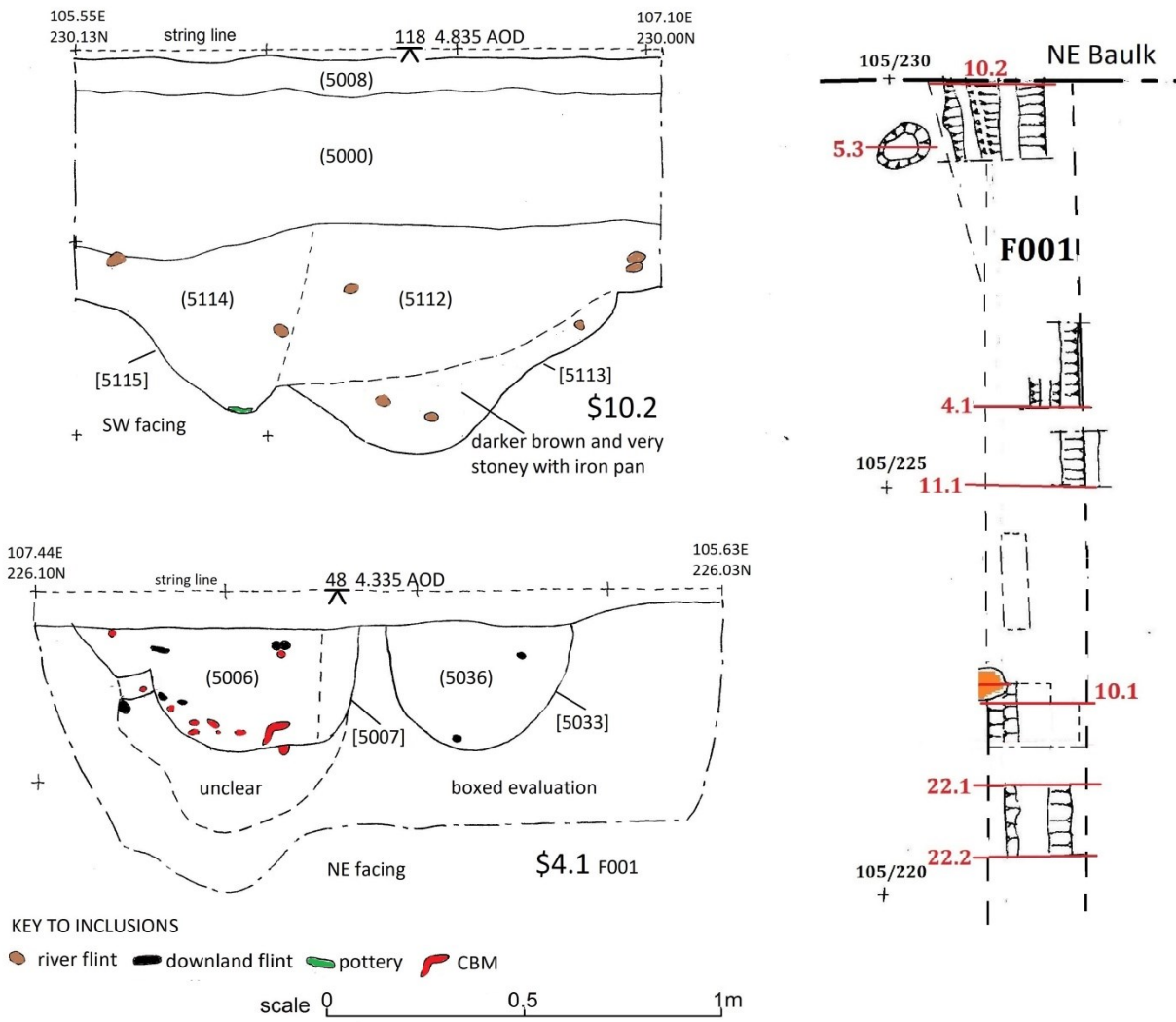

Location plan for 15.4.1/2

15.4.2: \$10.1 & 22.2 sections of Central Ditch F001 adjacent to hearth F002

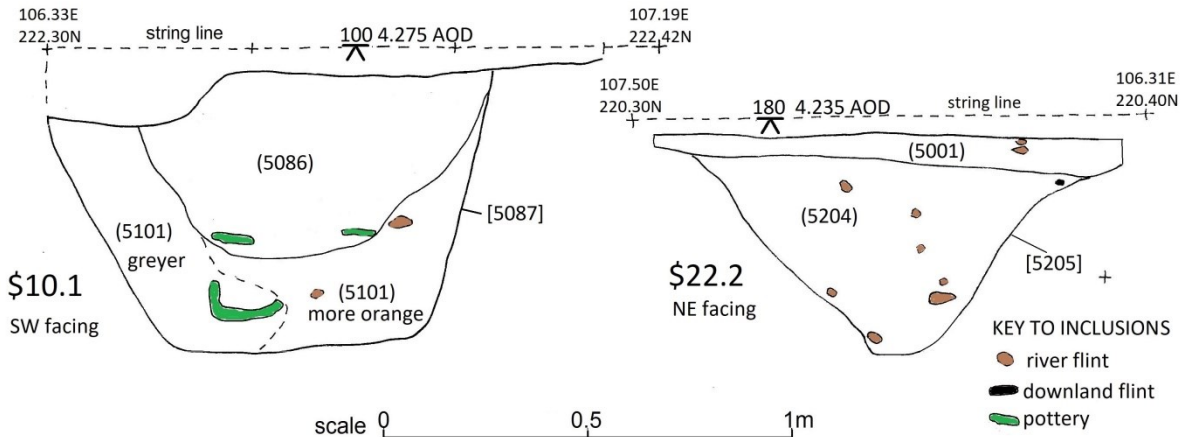

15.4.3: \$21.4, 8.1 & 2.1 sections of Central Ditch F001 in the SW half of the trench

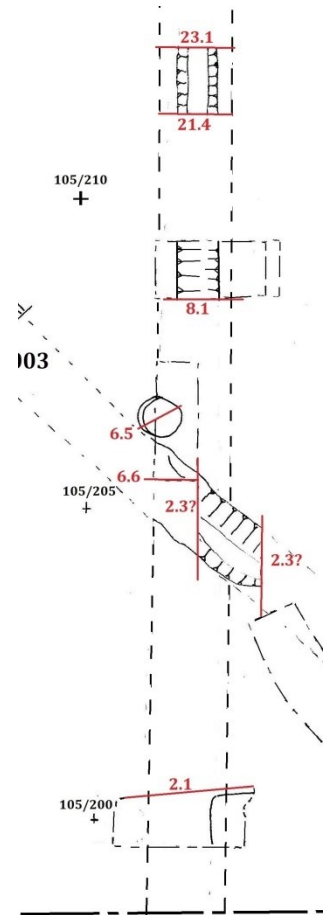
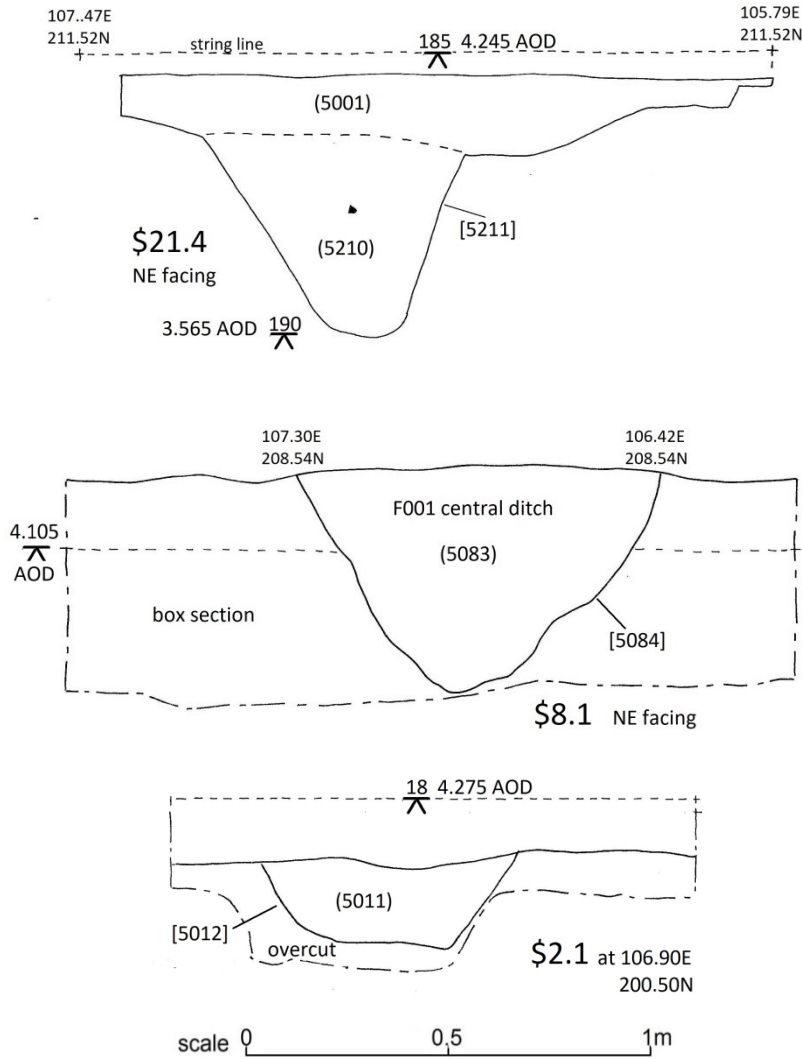

Location plan for 15.4.3

15.5 Section of the Hearth F002 (Roman Period 4)

15.5.1: \$13.3, section of the Banjo-shaped hearth F002

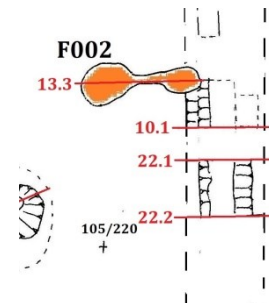
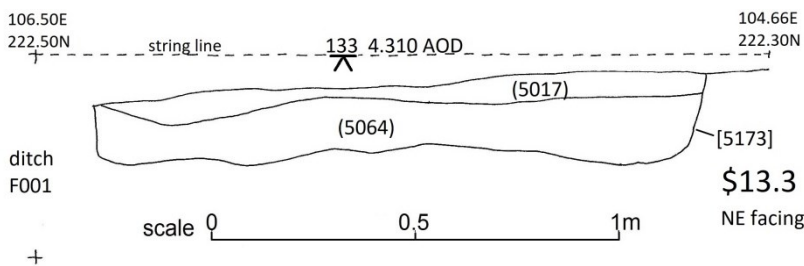

Location plan for 15.5

15.6 Sections of the large pit [5272] at the NW baulk (Roman period 5)

15.6.1: \$33.1, section of the pit at the baulk of the NW trench extension c.96.00E

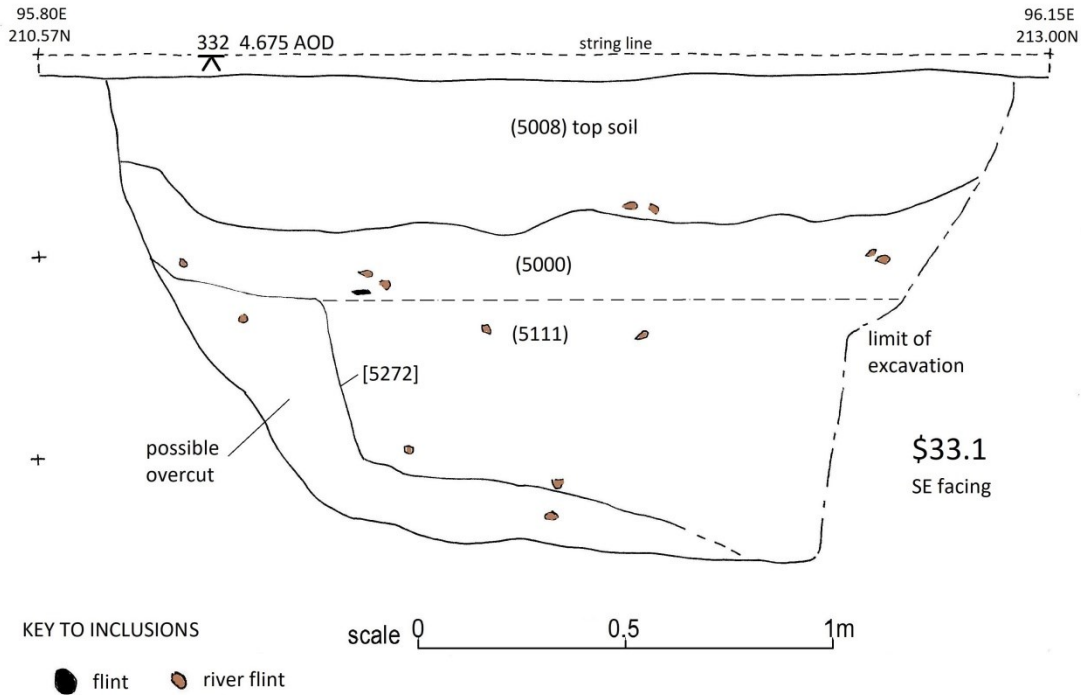

15.6.2: \$9.1 & 9.2 sections of the pit at the original NW baulk at 97.50E and at 98.30E (in blue) including ditch F003 [5014] that truncates the surface of the pit

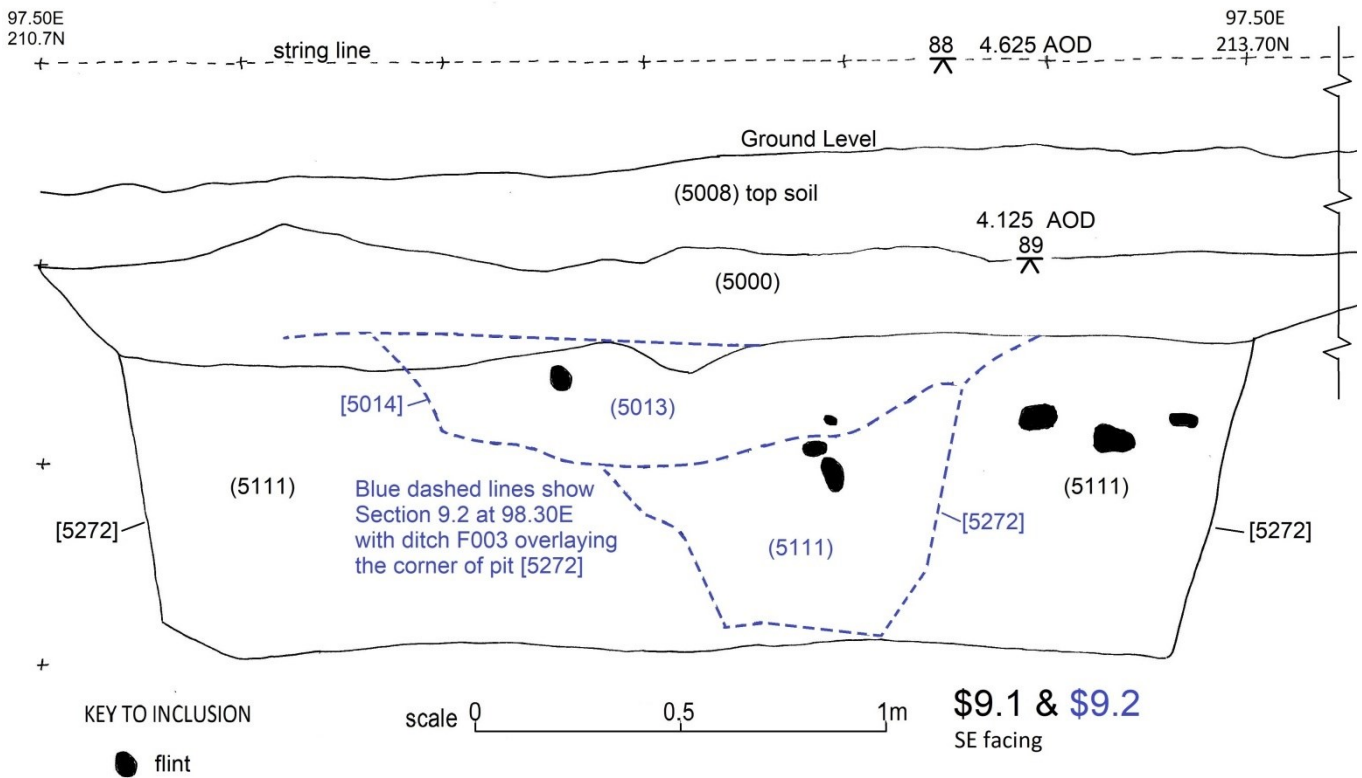

15.7 Sections of the postholes possibly forming a building F011A (Roman periods 5)

15.7.1: \$19.2, 19.4, 21.1, 30.1, 30.2, 30.3 & 31.1 sections of 7 postholes shown in location order

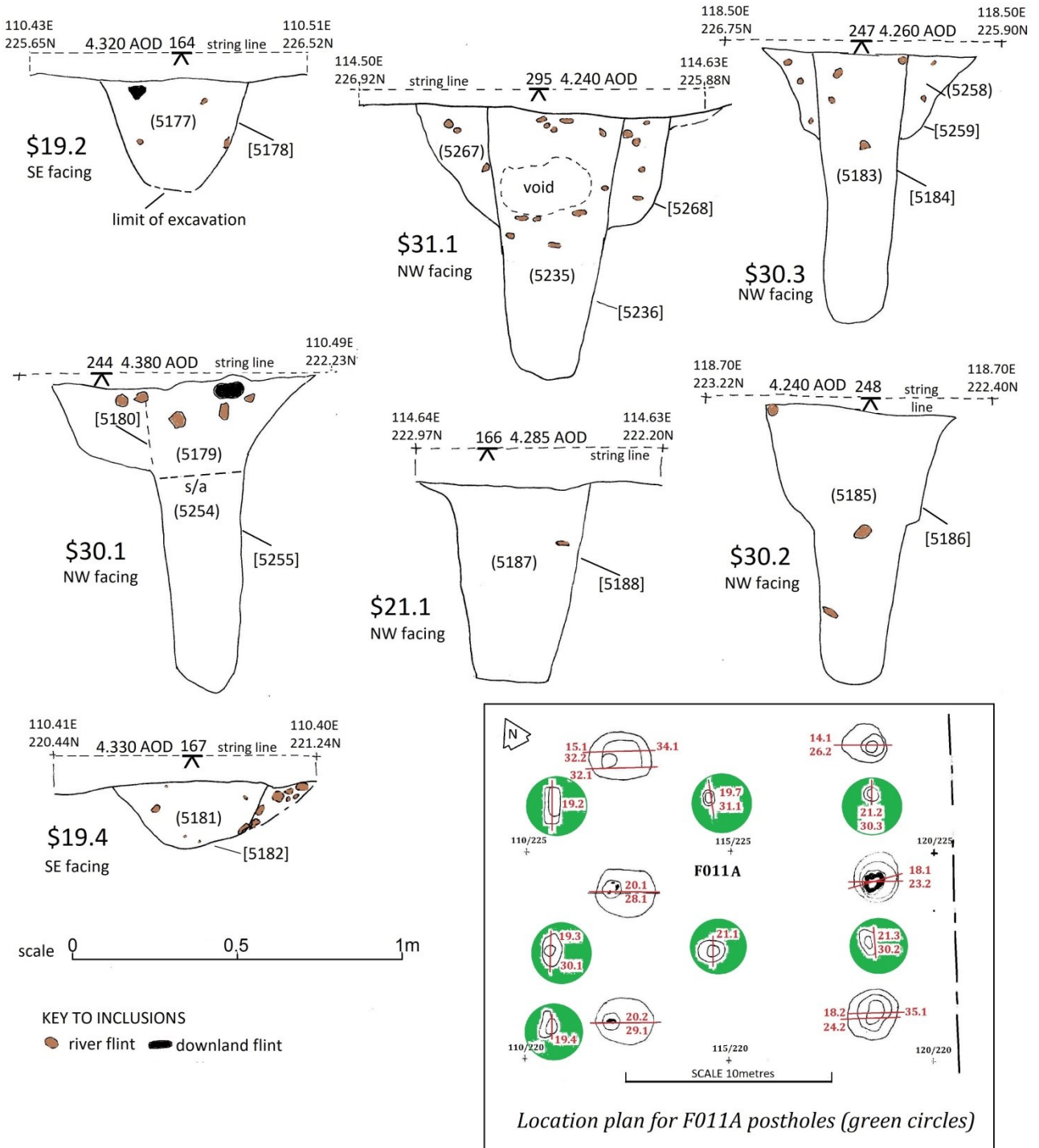

15.8 Sections of 2 shallow pits (Roman period 5)

15.8.1 \$8.2 & 12.3 sections of 2 pits adjacent to F010

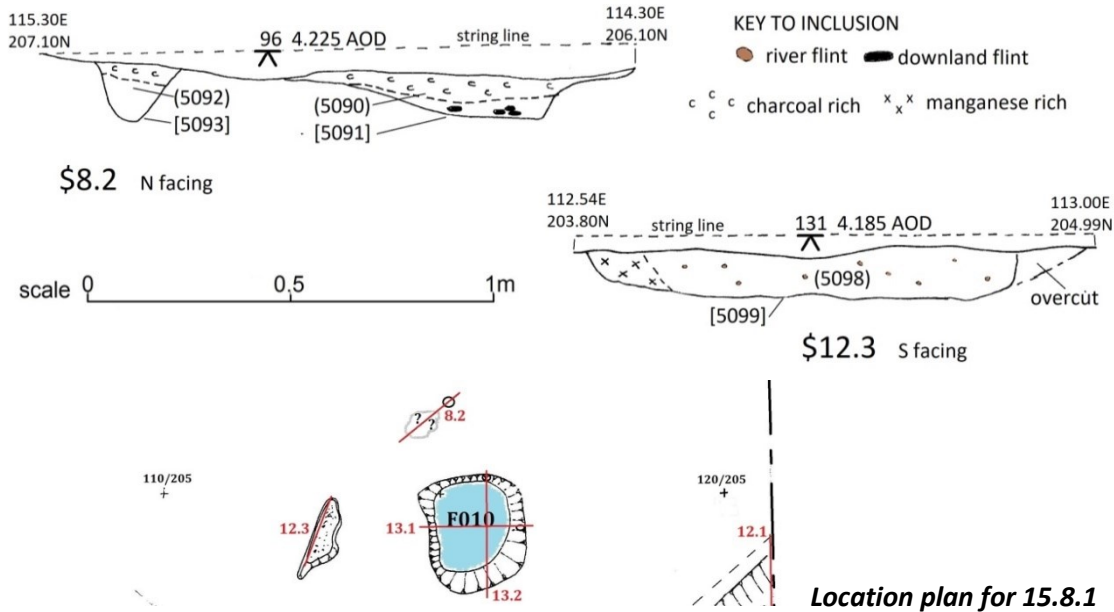

15.9 Sections of small linear F006 (Roman period not defined)

15.9.1 \$1.1, 6.1 & 6.2 of possible small ditch F006

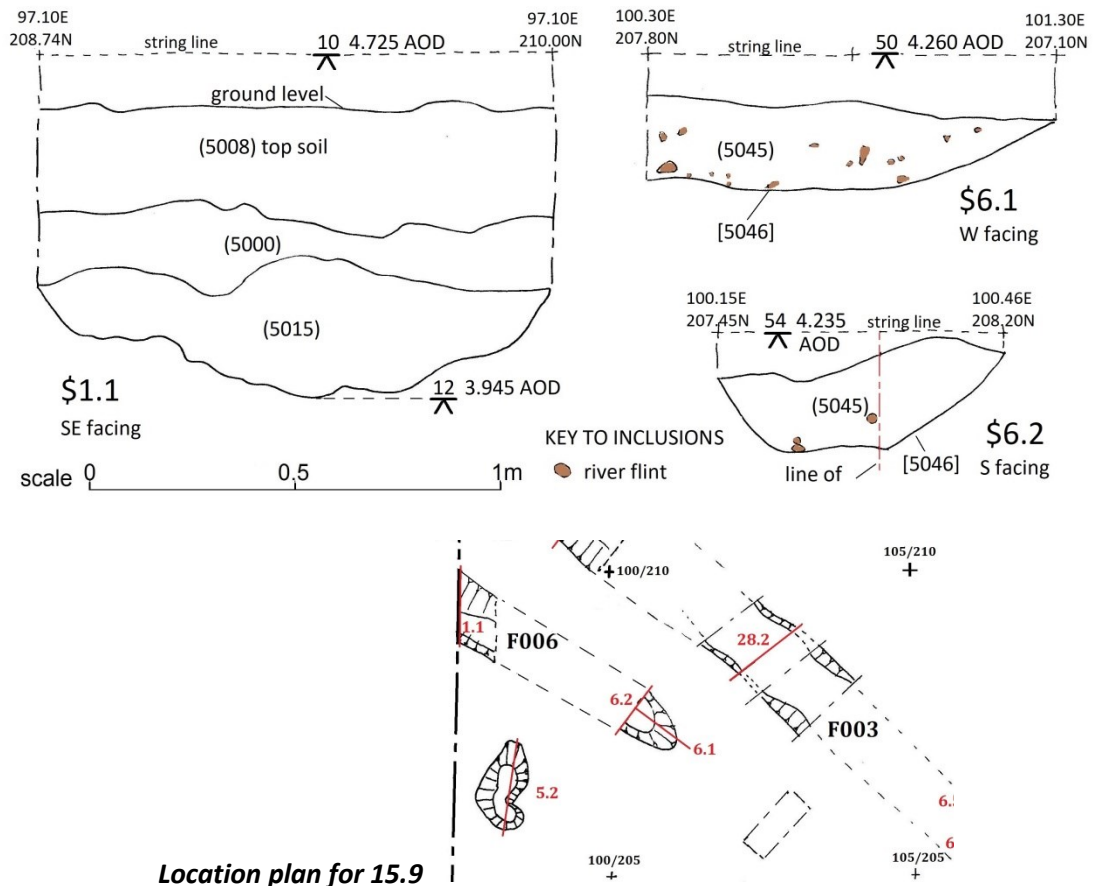

15.10 Sections of the posthole/small pit Groups 1, 2 & 3 (Roman periods 5-6)

15.10.1 \$3.1, 3.2, 3.4, 5.5 & 5.4 sections of Group 1 (Roman period 6)

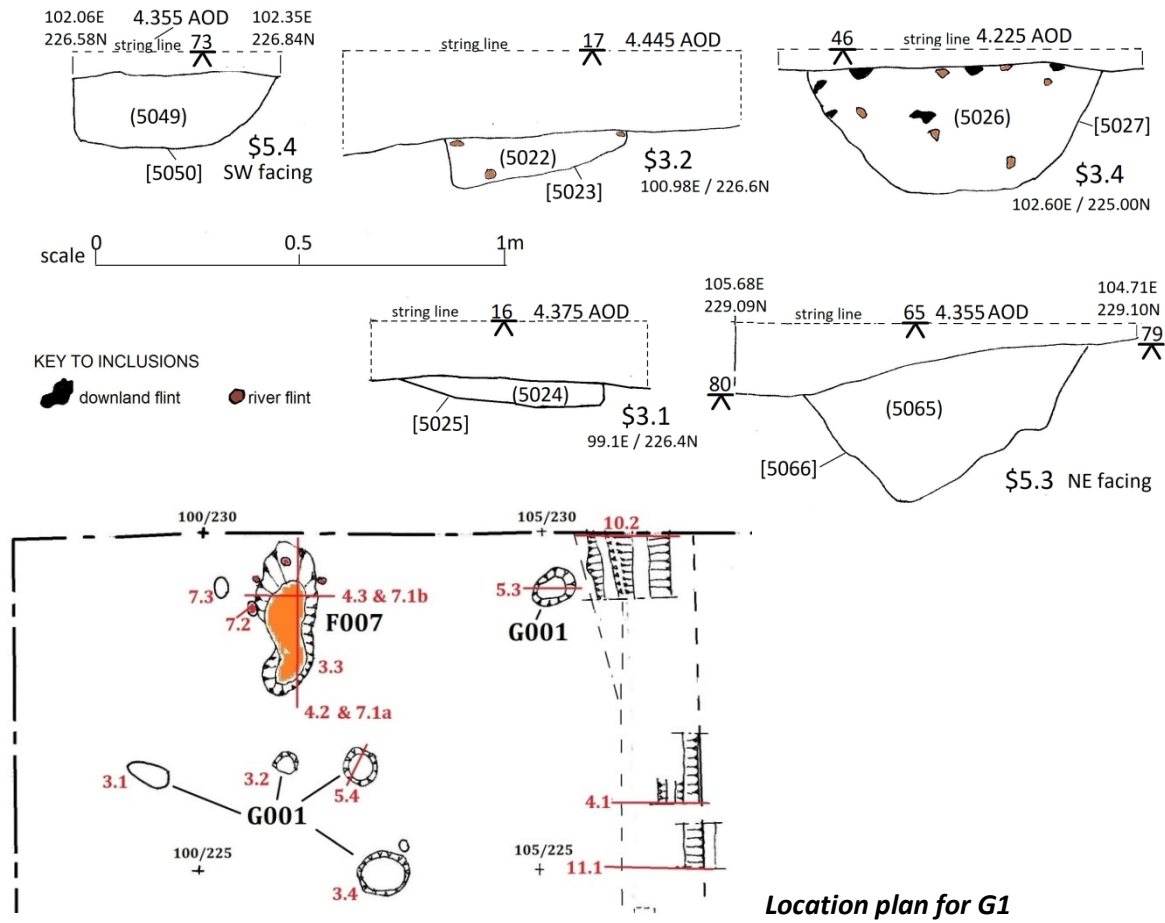

15.10.2 \$5.1 section of Group 2 (Roman period 6)

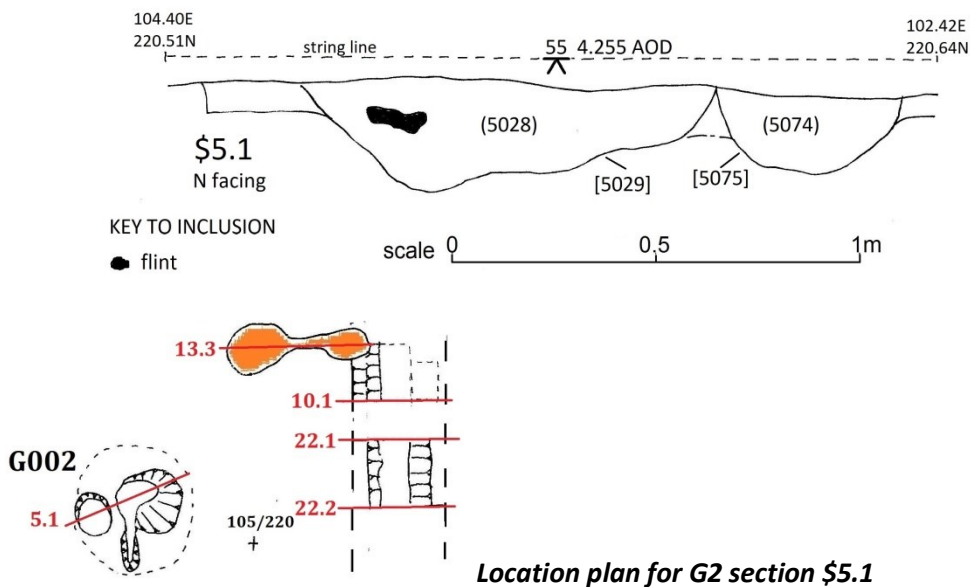

15.10.3 \$1.2, 2.4, 3.5, 3.6, 5.2, 6.3, 6.5 & 7.4 sections of Group 3 (Roman period 5-6)

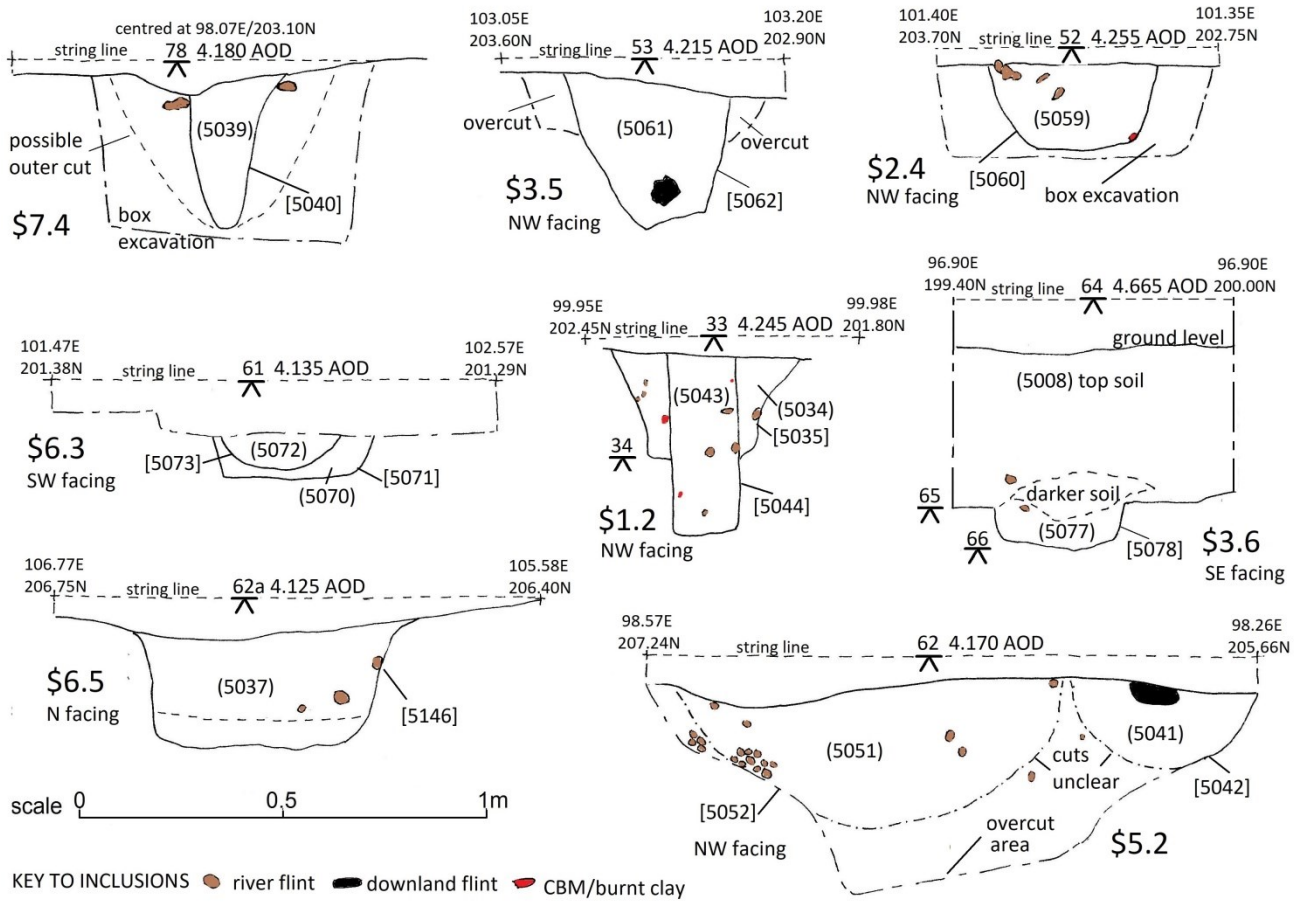

Location plan for G3 sections in 5.10.3

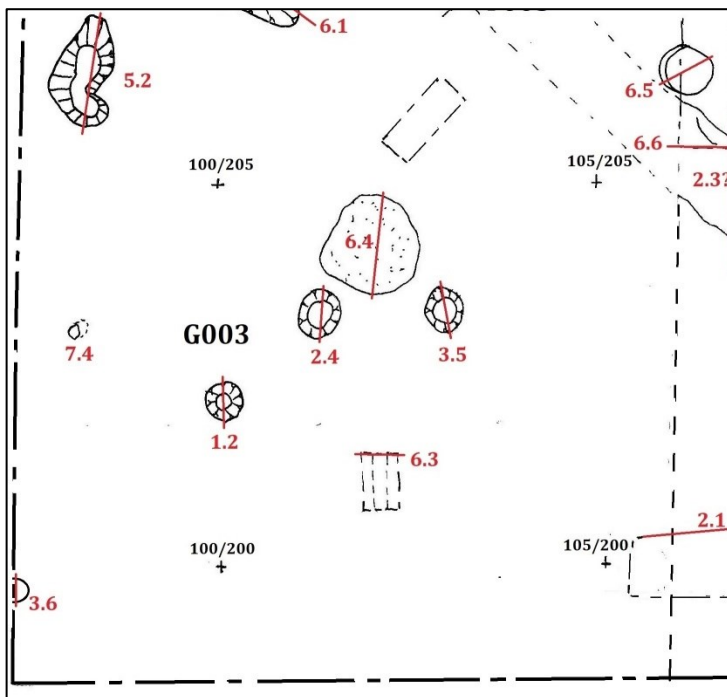

15.11 Sections of the 13 large postholes forming building F004 (Roman period 6)

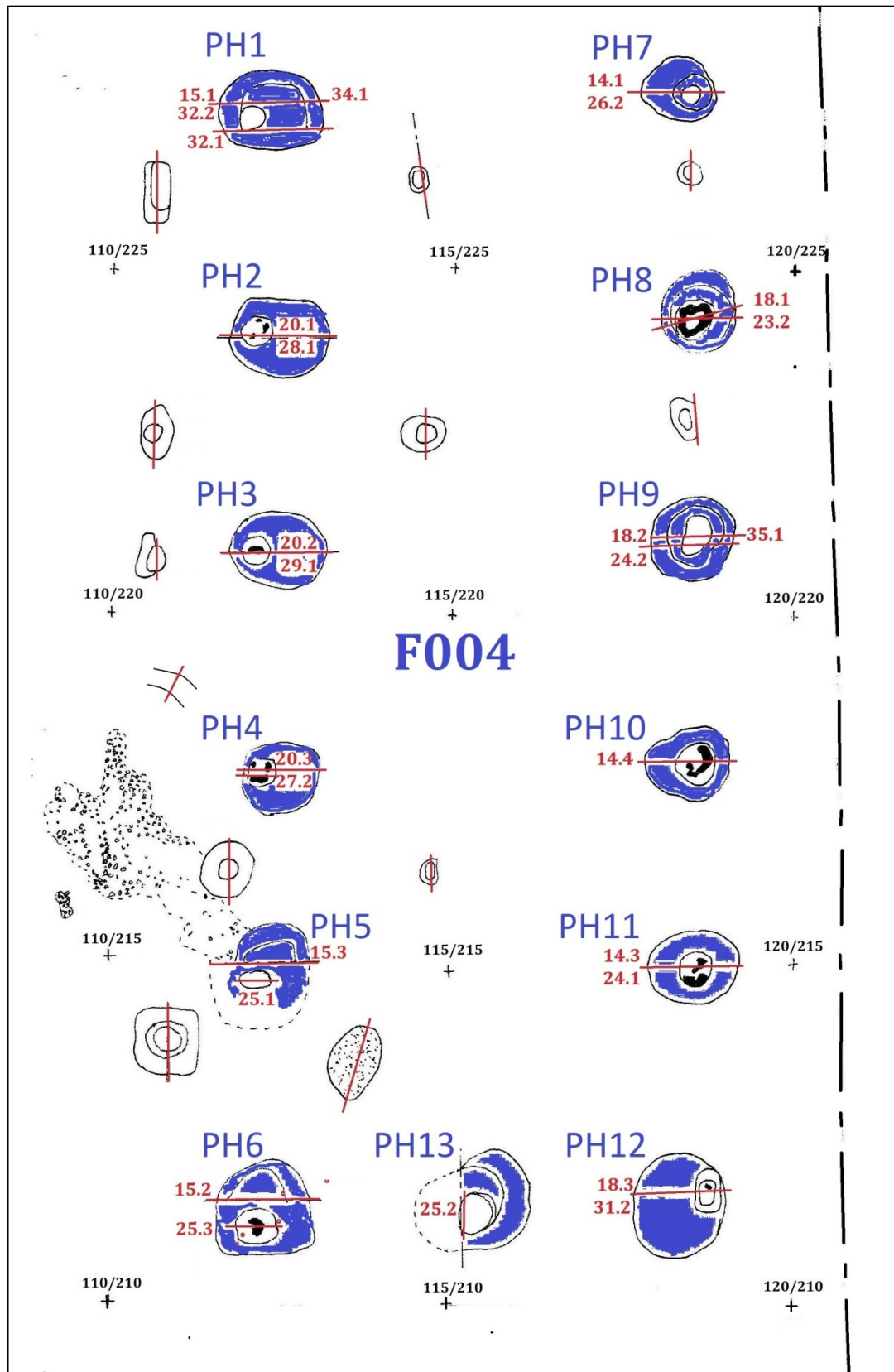

Location plan for F004 posthole sections (highlighted blue)

15.11.1 PH1 from sections 15.1, 32.1, 32.2 & 34.1 plus context matrix

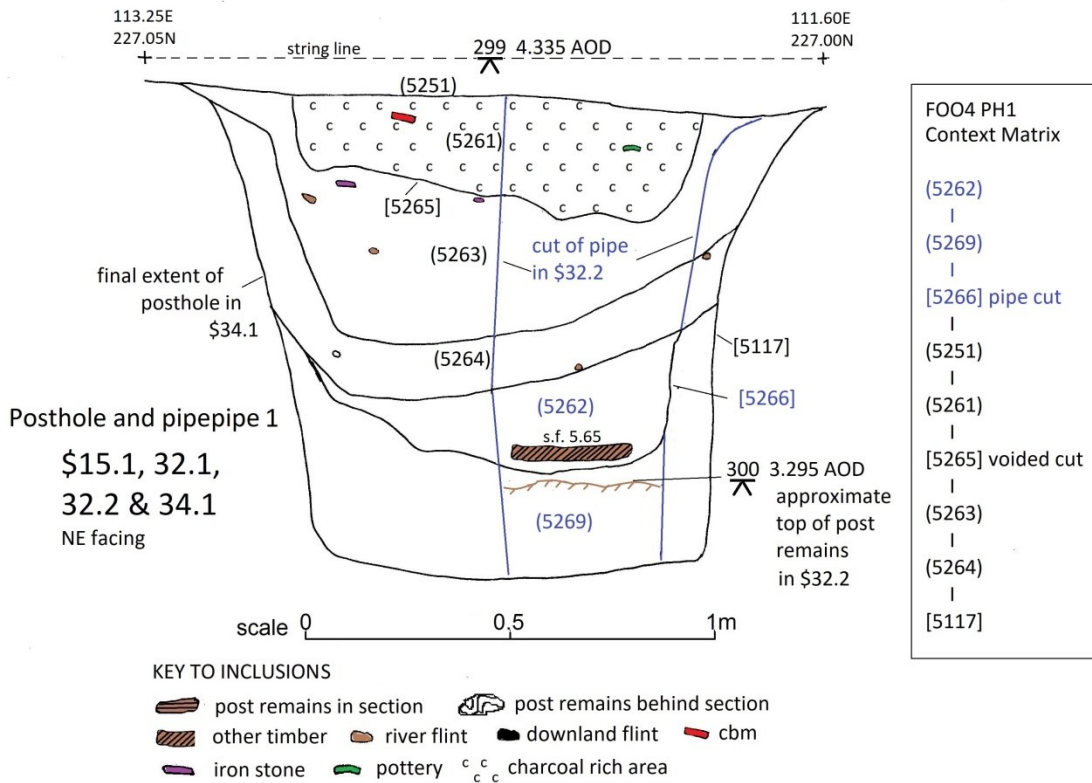

15.11.2 PH2 from sections 20.1 & 28.1

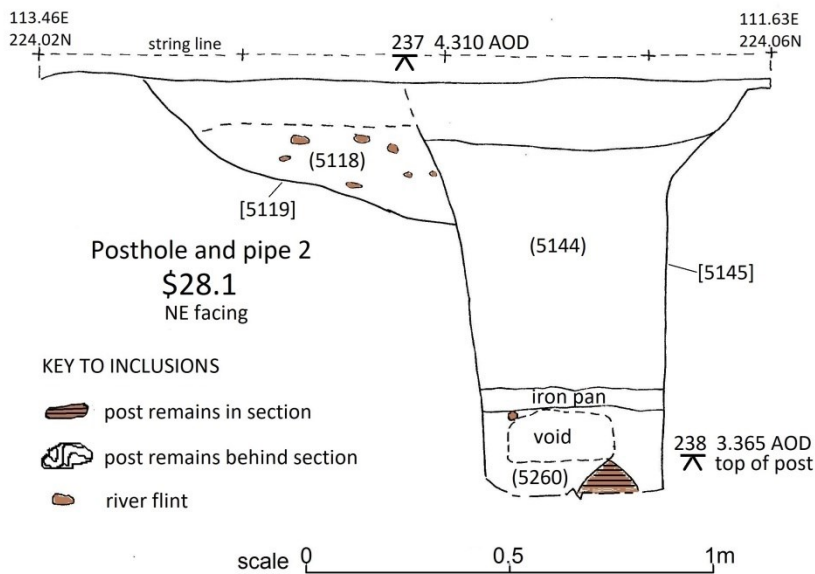

15.11.3 PH3 from sections 20.2/29.1

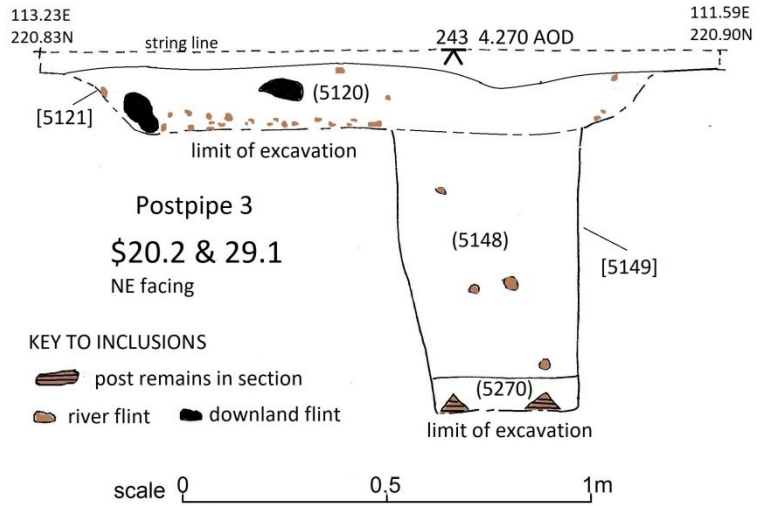

15.11.4 PH4 from sections 20.3/27.2

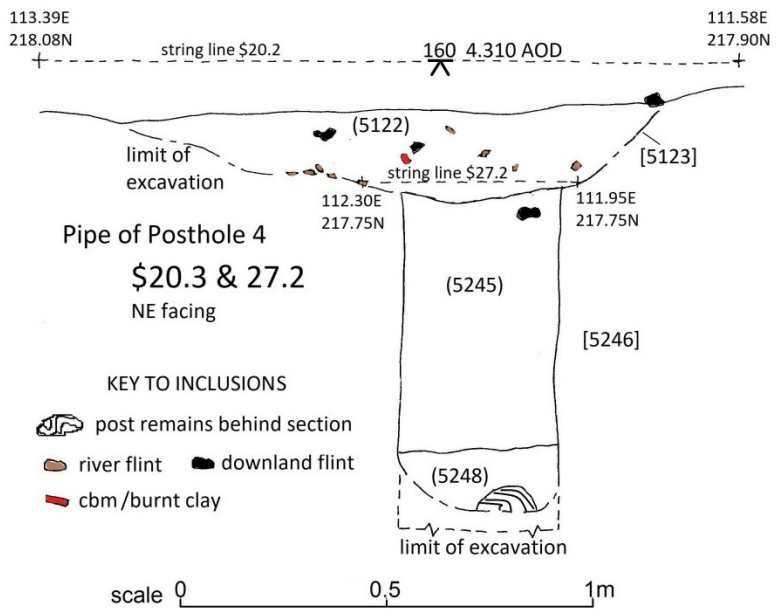

15.11.5 PH5 from sections 15.3/25.1

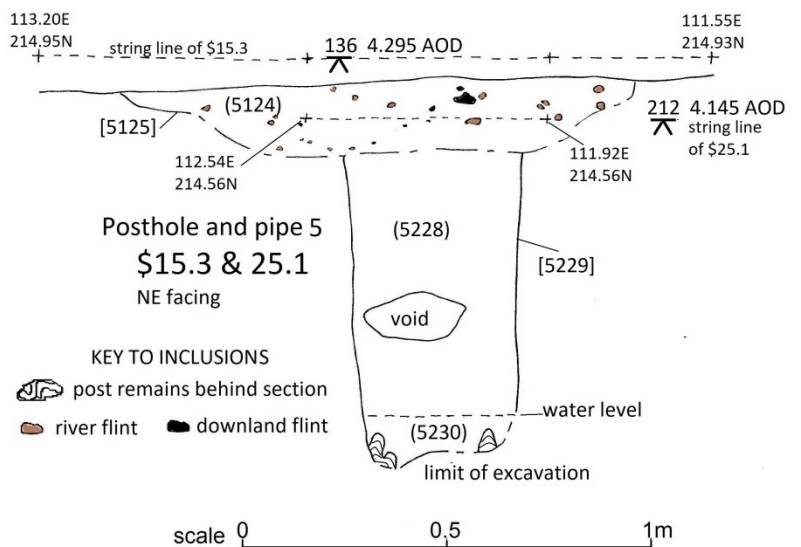

15.11.6 PH6 from sections 15.2 & 25.3

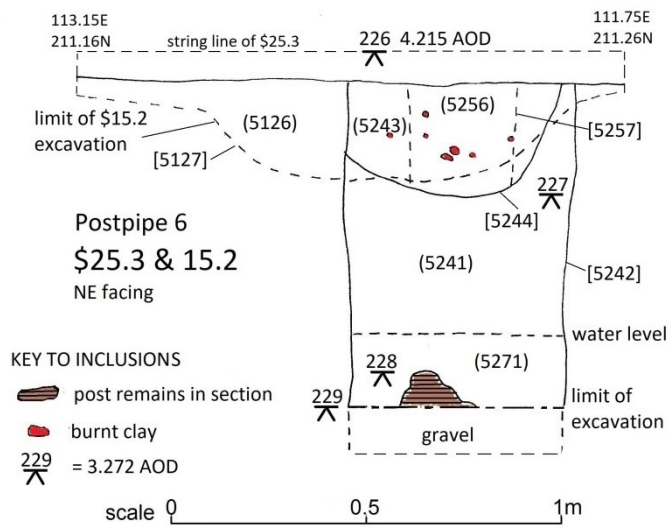

15.11.7 PH7 from section 26.2

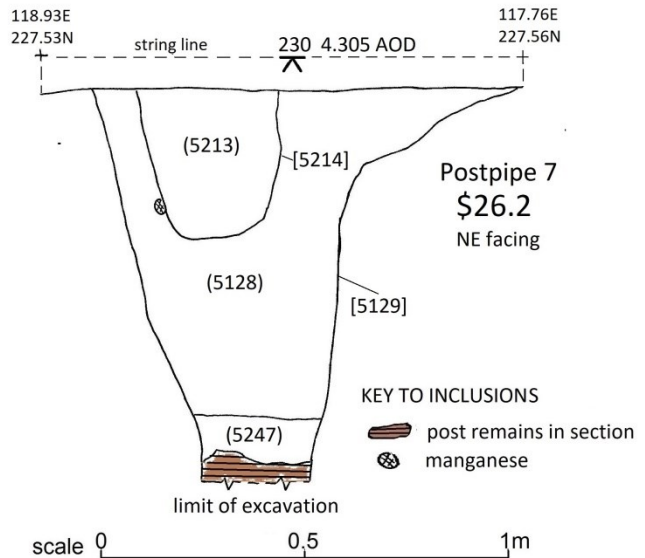

15.11.8 PH8 from sections 23.2 & 18.1



Context Matrix for PH8 of F004

- (5140) s/a (5201)
- |
- [5141] voided cut
- |
- (5201) s/a (5130)
- |
- (5223)
- |
- [5202] pipe cut
- |
- (5203) mixed surface
- |
- [5131] initial cut

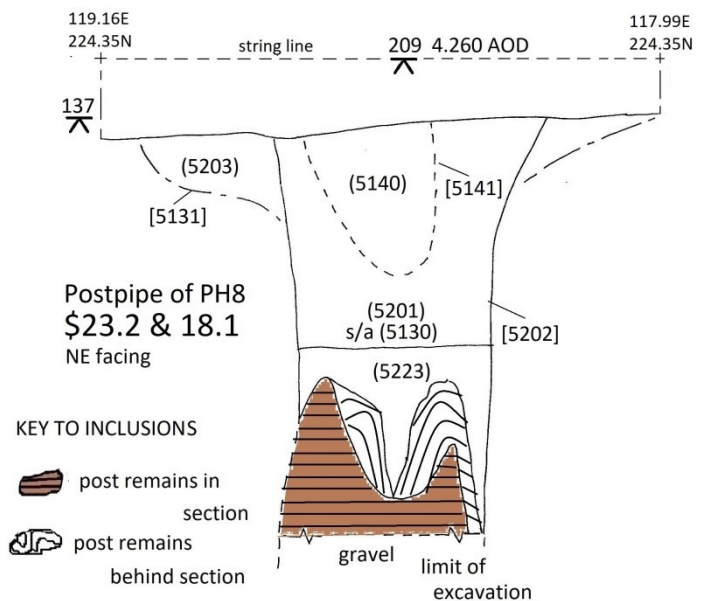

15.11.9 PH9 from sections

18.2, 24.2 & 35.1



100mm

removed post base

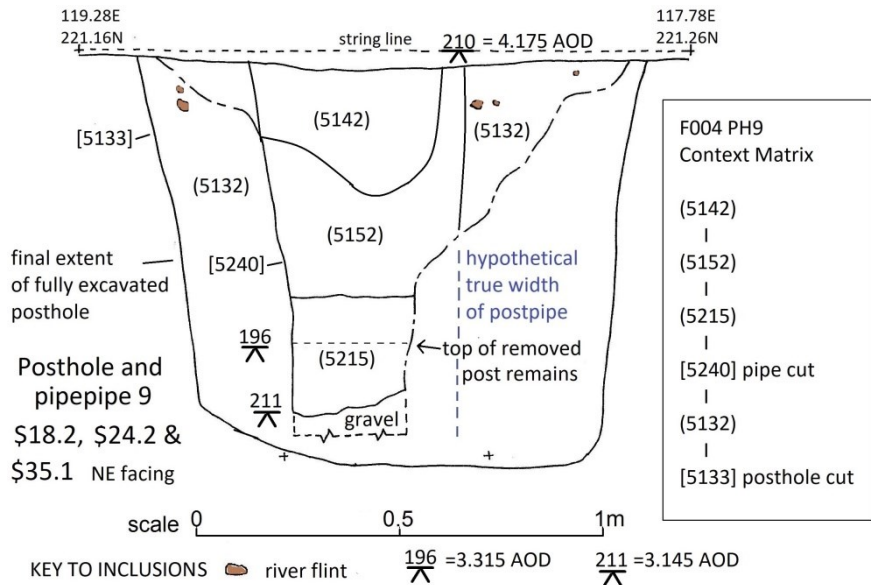

15.11.10 PH10 from section 14.4



Context Matrix (5134) s/a (5147) | (5216) | [5135] pipe cut | not excavated (5175) | posthole cut [5176] not excavated

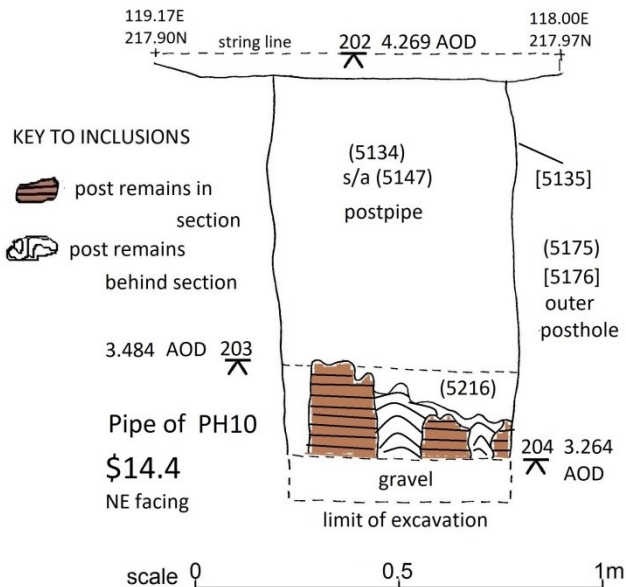

15.11.11 PH11 from section 24.1

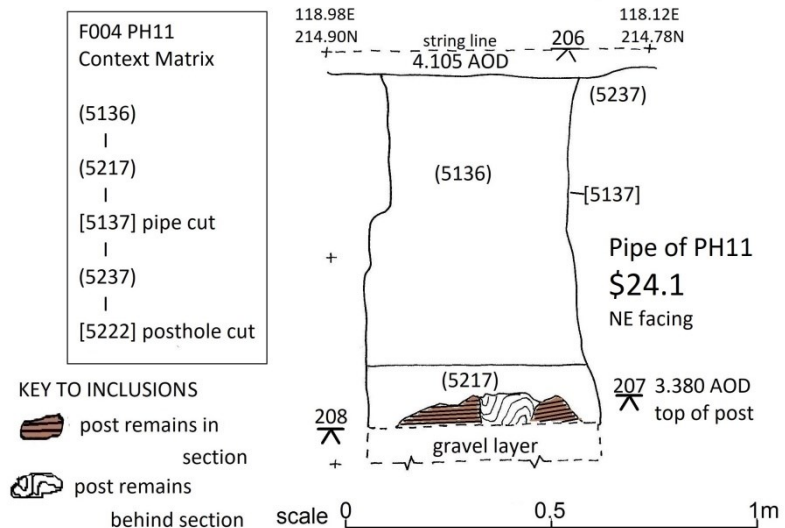

15.11.12 PH12 from section 31.2

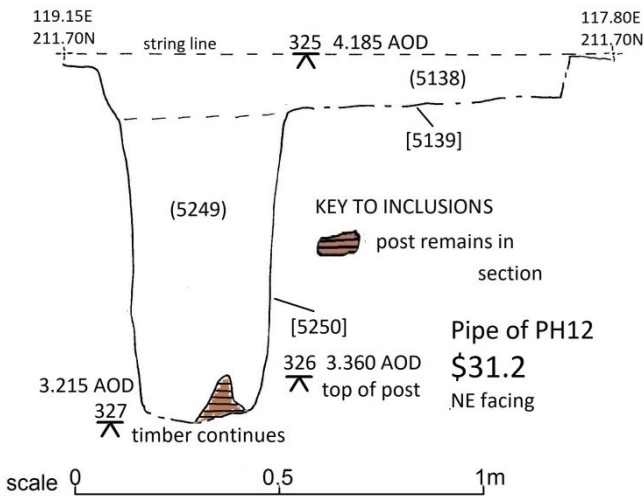

15.11.13 PH13 from section 25.2

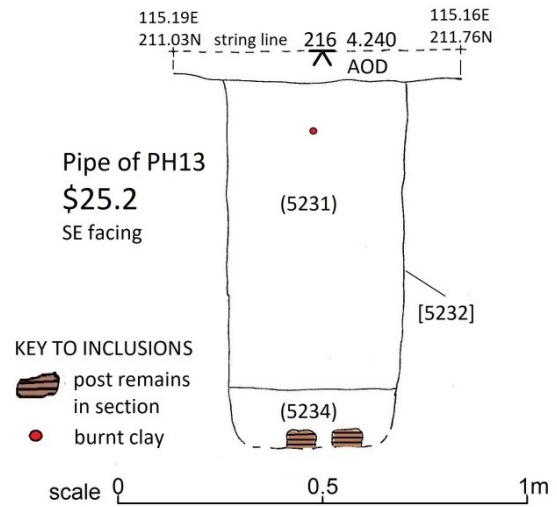

15.12 Sections of the posthole group F011B (Roman period 6)

15.12.1 Posthole sections \$19.5, 26.1 & 27.1 and shallow pit \$4.4 plus location plan

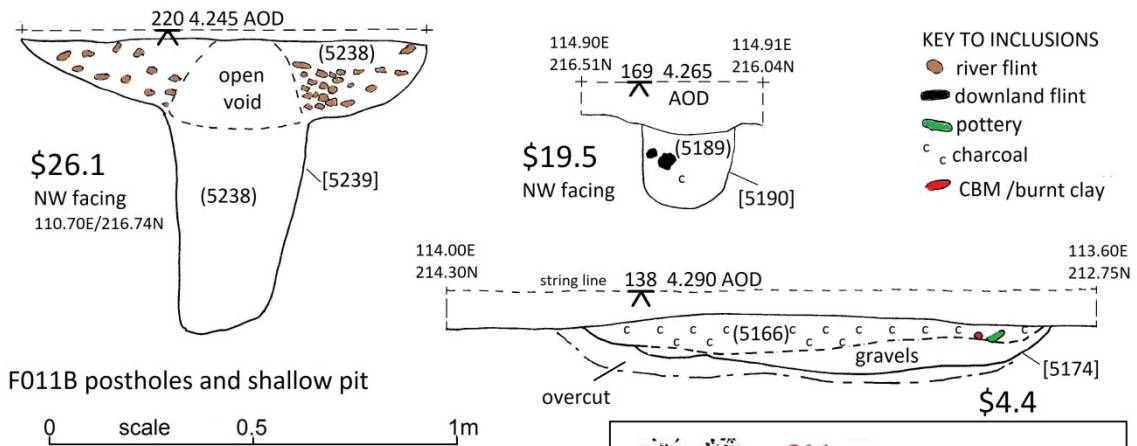

F011B postholes and shallow pit

0 scale 0.5 1m

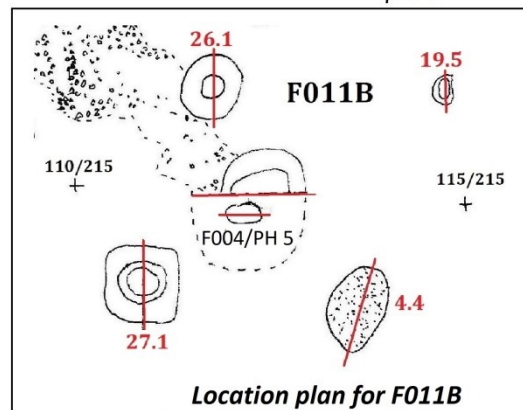
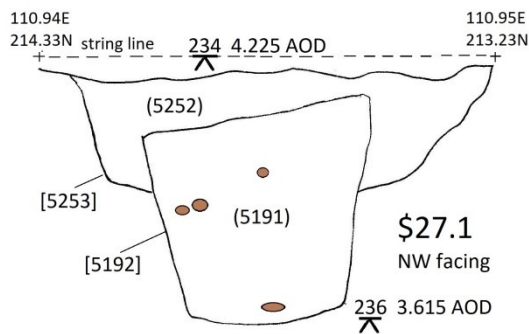

Location plan for F011B

15.13 Sections of the sump well F009 and large pit F010 (Roman period 6c)

15.13.1: \$17.1 SW/NE sections of sump well F009. Site grid ref: 104.36E 215.35N

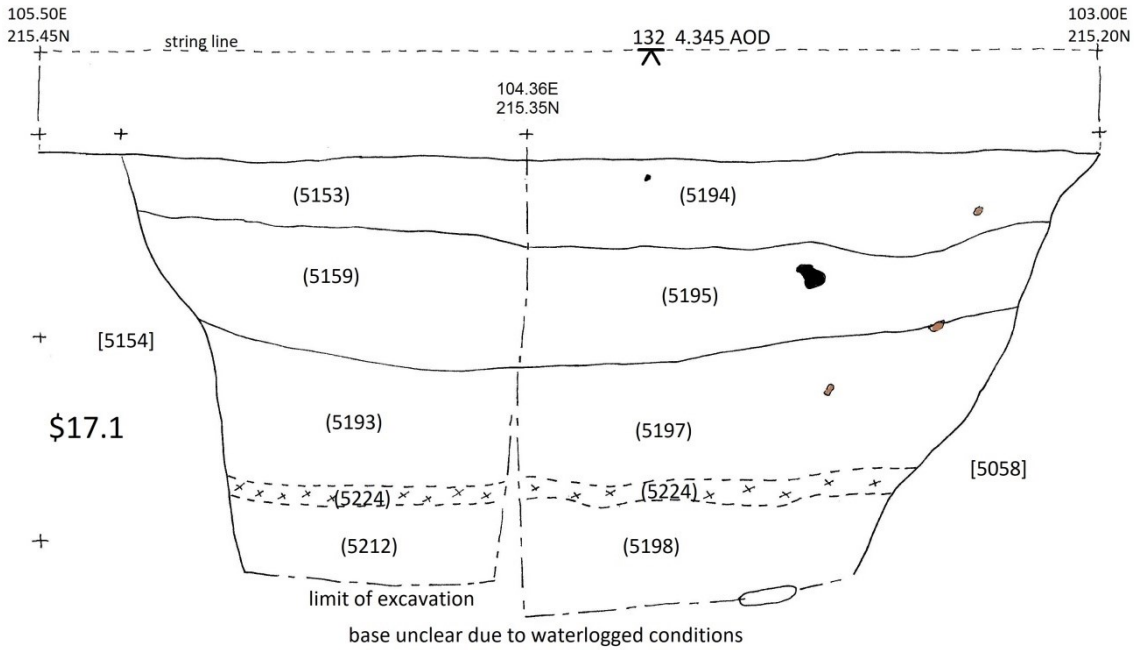

15.13.2: \$16 SE/NW sections of large pit/sump well F009. Site grid ref: 104.36E 215.35N

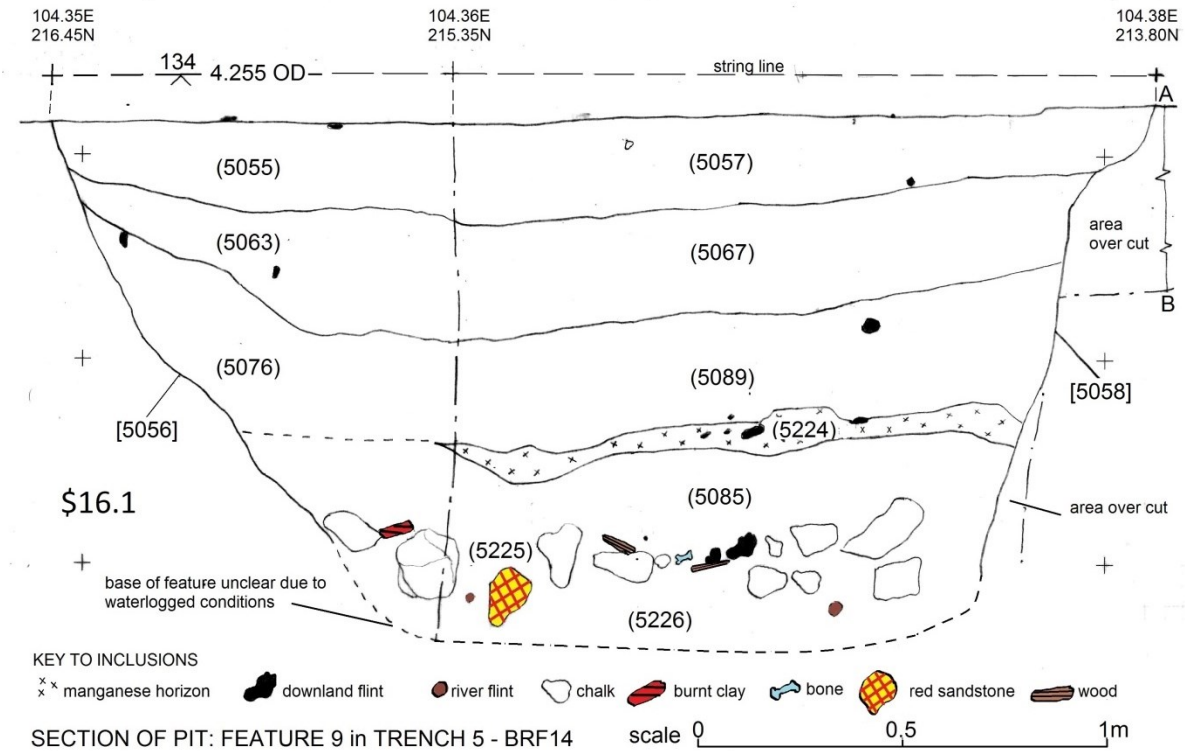

15.13.3: \$13.1 SW/NE facing sections of large pit F010. Site grid ref: 115.76E 204.40N

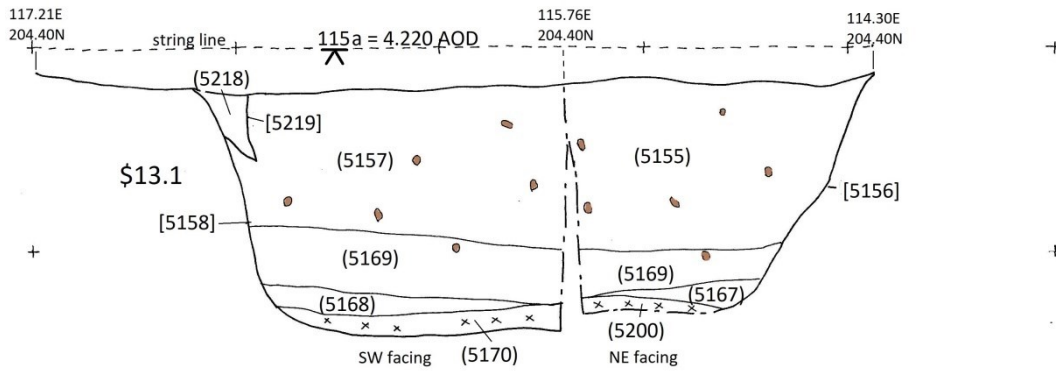

15.13.4: \$13.2 SE/NW facing sections of large pit F010. Site grid ref: 115.76E 204.40N

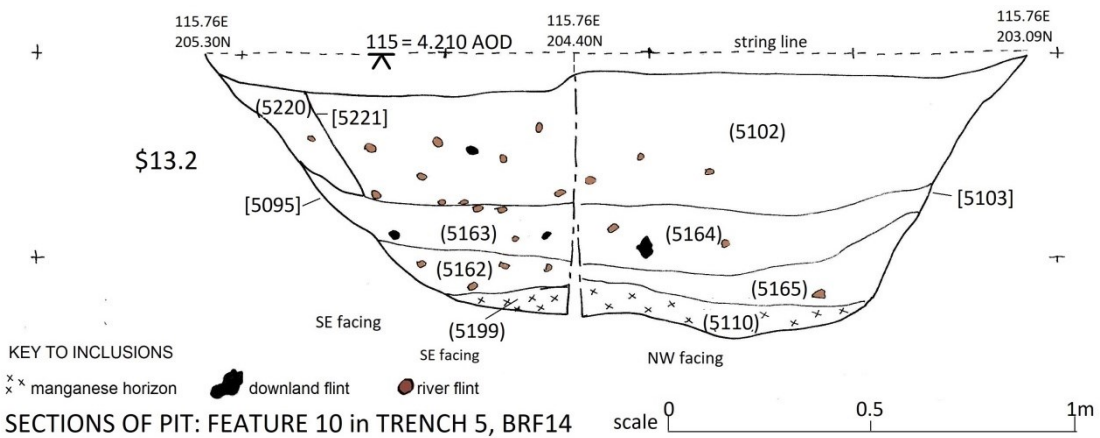

15.14 Sections of hearth F007 and adjacent stakeholes (Roman period 6c)

15.14.1 Sections \$7.1a, 7.1b & 3.3 of the hearth with \$7.2 & 7.3 of the stakeholes

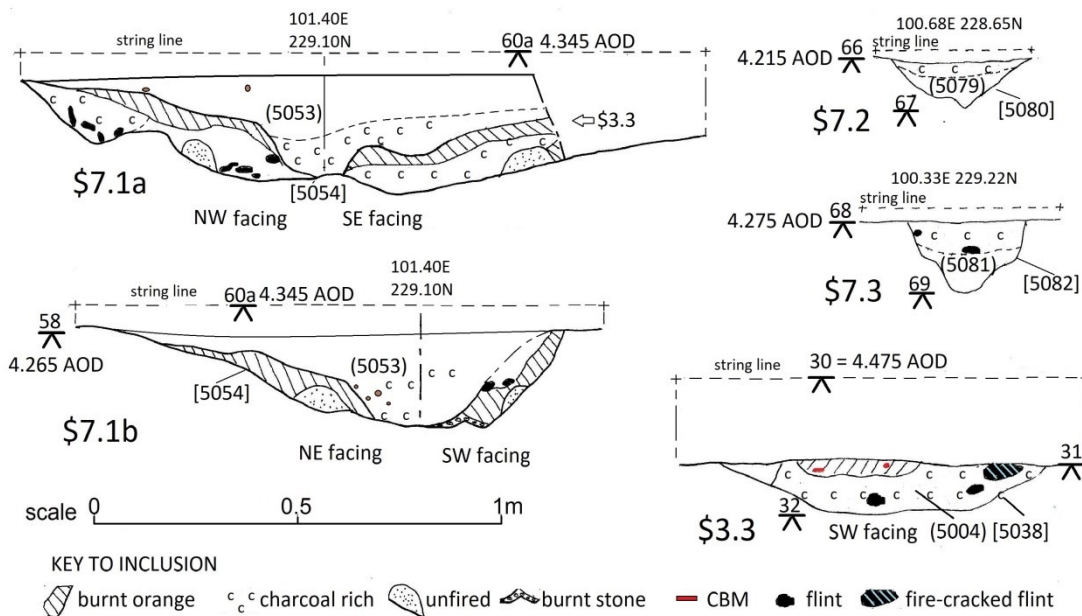

15.15 Sections of ditches F003 and F008 (Roman period 6c)

15.15.1 Sections \$2.2, 8.3 & 28.2 of ditch F003

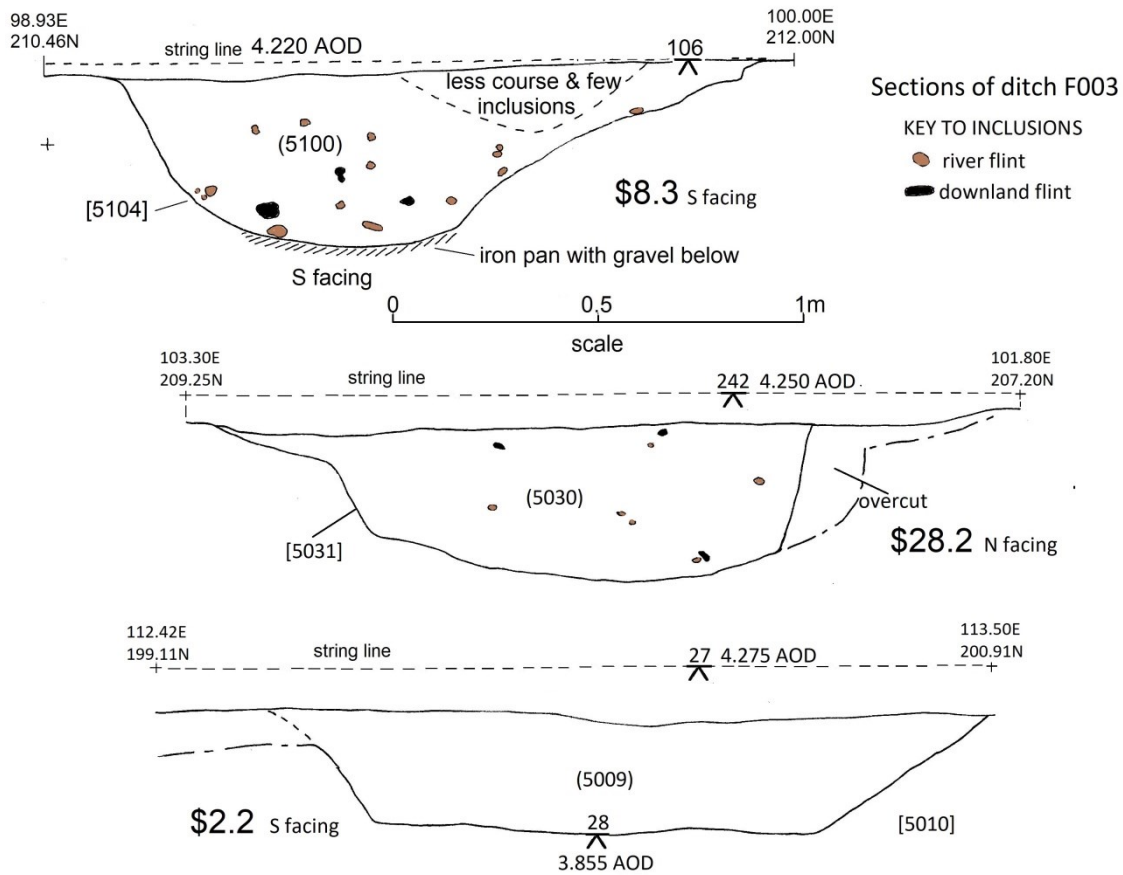

15.15.2 Section \$11.2 of F003/F008 intesection and sections \$12.1 & 12.2 of ditch F008

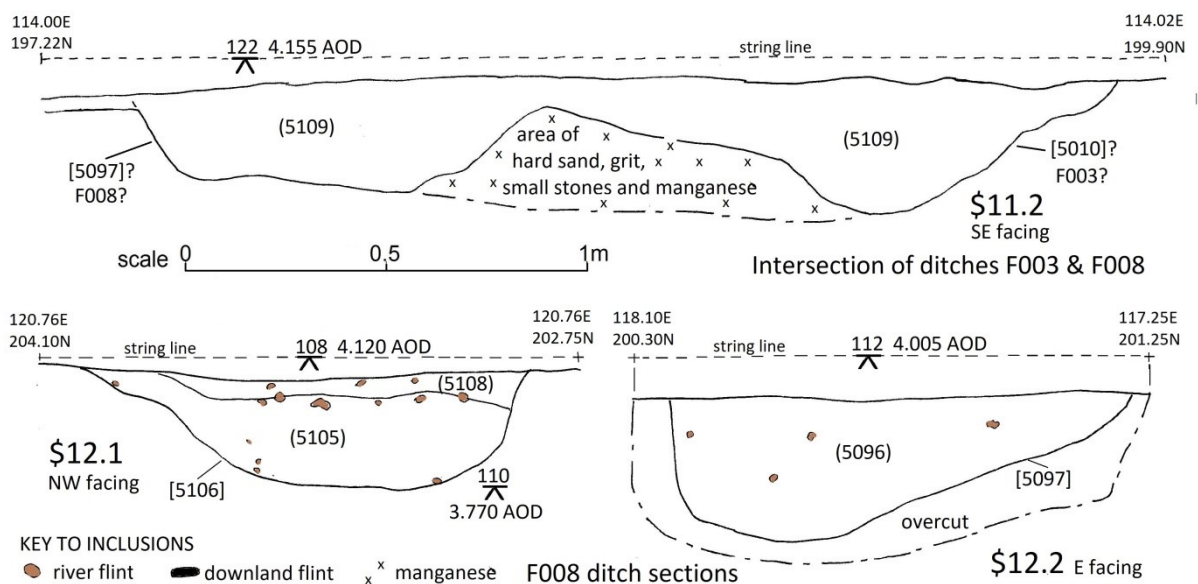



Location plan for 15.15 ditch section from F003 & F008 and 15.16.1 \$19.6 (see below)

15.16 Sections of F005 and gully ditch west of F003 (Roman period undefined)

15.16.1 \$22.3 section of small gully around the flint surface F005

15.16.2 \$19.6 section of terminal of small linear west of F003 at SW baulk, possible F006 continuation

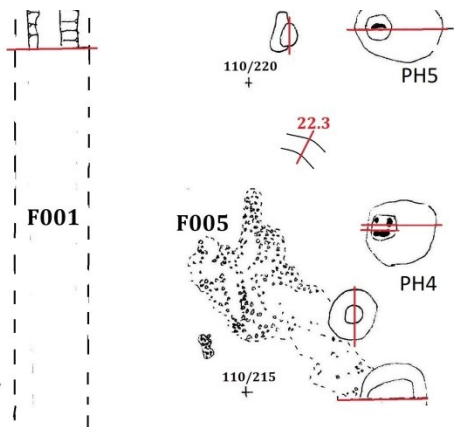
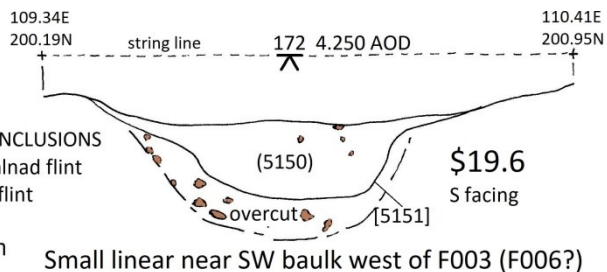
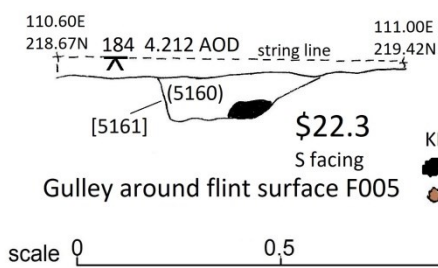

Location plan for \$22.3 of F005