

A Roman farmstead at North Lodge, Barnwell: Excavations 1973-1988

by Stephen G Upex

with contributions by
Roy Friendship-Taylor, Bethan R Upex, Phillipa Walton and Felicity C Wild

Part 2: Catalogue of pottery, other finds and animal bone

The catalogue of pottery

The catalogue of pottery is organised into the types of vessels which are represented within the assemblage. Each entry has a site code and a period association. The fabric and colour of the vessels were matched with those of the *Munsell Soil Color Charts* (1971 edition) and are given in a 'range' form because the colour of any vessels' fabric and surfaces were rarely uniform and often with considerable variation. The colours below are given in numerical form prefixed by the letters CR and are listed below.

Notation

- 1 Where a number of different colours occur arbitrarily on the same vessel, the ranges are linked with a + (eg 10+24).
- 2 Where the core varies from the surface the colours are separated by a / (eg 18/14/18). In these cases, the internal surface colour is given first, then the core, then the external surface. The colours of the surfaces can vary (eg 18/14/22).
- 3 Where there is a 'sandwich' core, the colour(s) of this are separated from the surface by a // (eg 21//11/19/11//21).
- 4 Where the colour of a vessel is uniform except for just one surface, a hyphen is used (eg 3-14). Sooting is not treated as a colour.
- 5 If the surface of a vessel has different coloured zones or areas, these are distinguished by a comma followed by text (eg 18/5/18, 21 patches).
- 6 Colour ranges are not given for non-local wares which are described separately or adequately elsewhere.

Colour Ranges*Table 2.1: Colour ranges*

1	weak red	10R4/4, 2.5YR4/2
2	red	10R4/6, 2.5YR5/6, 2.5YR5/8
3	light red	10R6/6, 2.5YR6/6, 2.5YR6/8
4	(reddish yellow) (yellowish red)	5YR5/6, 5YR6/6, 5YR6/8, 5YR7/6 5YR7/8, 7.5YR6/8, 7.5YR7.6, 7.5YR7/8, 7.5YR8/6
5	pink	5YR7/4, 5YR8/4, 7.5YR7/4, 7.5YR8/4
6	pinkish white	5YR8/2, 7.5YR8/2
7	pinkish grey	5YR6/2, 5YR7.2, 7.5YR6/2, 7.5YR7/2
8	reddish brown	2.5YR4/4, 2.5YR5/4, 5YR4/3, 5YR4/4, 5YR5/3, 5YR5/4
9	light reddish brown	2.5YR6/4, 5YR6/4
10	light brown	7.5YR6/4
11	brown	2.5YR5/2, 7.5YR5/2, 7.5YR5/3, 7.5YR5/4, 10YR5/3
12	dark brown	7.5YR3/2, 10YR4/3
13	dark reddish brown	5YR2.5/2, 5YR3/1
14	very pale brown	10YR7/3, 10YR7/4, 10YR8/3, 10YR8/4
15	light brownish grey	2.5YR6/2, 10YR6/2
16	greyish brown	10YR5/2, 2.5Y5/2
17	dark/very dark greyish brown	10YR3/2, 10YR4/2, 2.5Y3/2, 2.5Y4/2
18	light grey	5YR7/1, 7.5YR7/0, 10YR7/1, 10YR7/2, 2.5Y7/2, N7
19	light grey/grey	5YR6/1, 10YR6/1, N6, 5Y6/1
20	grey	10YR5/1, 5Y5/1, N5
21	dark grey	10YR4/1, 5Y4/1, N4
22	very dark grey	5YR3/1, 10YR3/1
23	light olive grey	5Y6/2
24	light blue grey	5B7/1
25	dark greenish grey	5BG4/1
26	white	5YR8/1, 7.5YR7/0, 10YR8/1, 10YR8/2, 2.5Y8/2
27	yellow	10YR7/6, 10YR8/6
28	black/reddish black	10R.2.5/1, 2.5YR2.5/0, 5YR2.5/1, 10YR2.5/1, 2.5YN2.5/0, 5Y2.5/1, 5Y2.5/2

Grey ware jars (Fig 2.1)

- 1 CR19/19/19, slightly burnished external surfaces (see Perrin 1999, fig 57, 34-40) (BNL86 E29), surfacing of yard, Period 3/5
- 2 CR20/19/20, slightly burnished external surfaces-(Perrin 1999, fig 57, 37-38) (BNL73 A14) from pit III, see section B-C, Period 5
- 3 CR19/19/19, (BNL73 A8) from pit III, see section BC- Period 6
- 4 CR19/19/19, (BNL73 A7) from pit III, Period 6
- 5 CR21/20/21, complete profile of vessel with roughened external surface below the shoulder (BNL85 D 12) from pit I, see section E-F- Period 5
- 6 CR20/19/20, (BNL 73 A18) from clay layer over revetment at the east end of pit III, Period 4, see section D-E

A ROMAN FARMSTEAD AT NORTH LODGE, BARNWELL

- 7 CR20/18/20, rough sandy finish both internally and externally (BNL73 B2) from destruction layer over bath area, see section D-E- Period 6
- 8 CR18, 21/18/18, (BNL85 D14) top fill of gully 18, see Fig 2, Period 1
- 9 CR16//9/19/9//16, 9, waster? (BNL86 D28) lower fill of pit II, see section F-G, Period 4, Lid seated vessels are common in the late 1st/early 2nd centuries, but the context of this one appears to be from the late 3rd and into the early 4th century.
- 10 CR19/18/20, (BNL85 D14) upper fill of gully 18, see 8 above. This vessel is similar in form and fabric to those found in a kiln at Sulehay, near Wansford, which was dated to the mid-2nd century and the context from which this vessel comes would match this date and perhaps even push the production a decade or two earlier (Hadman & Upex 1975, fig 7; Perrin 1999, fig 56, 21-25, see also Rollo and Wild 2001, fig 39,114-116). Period 1

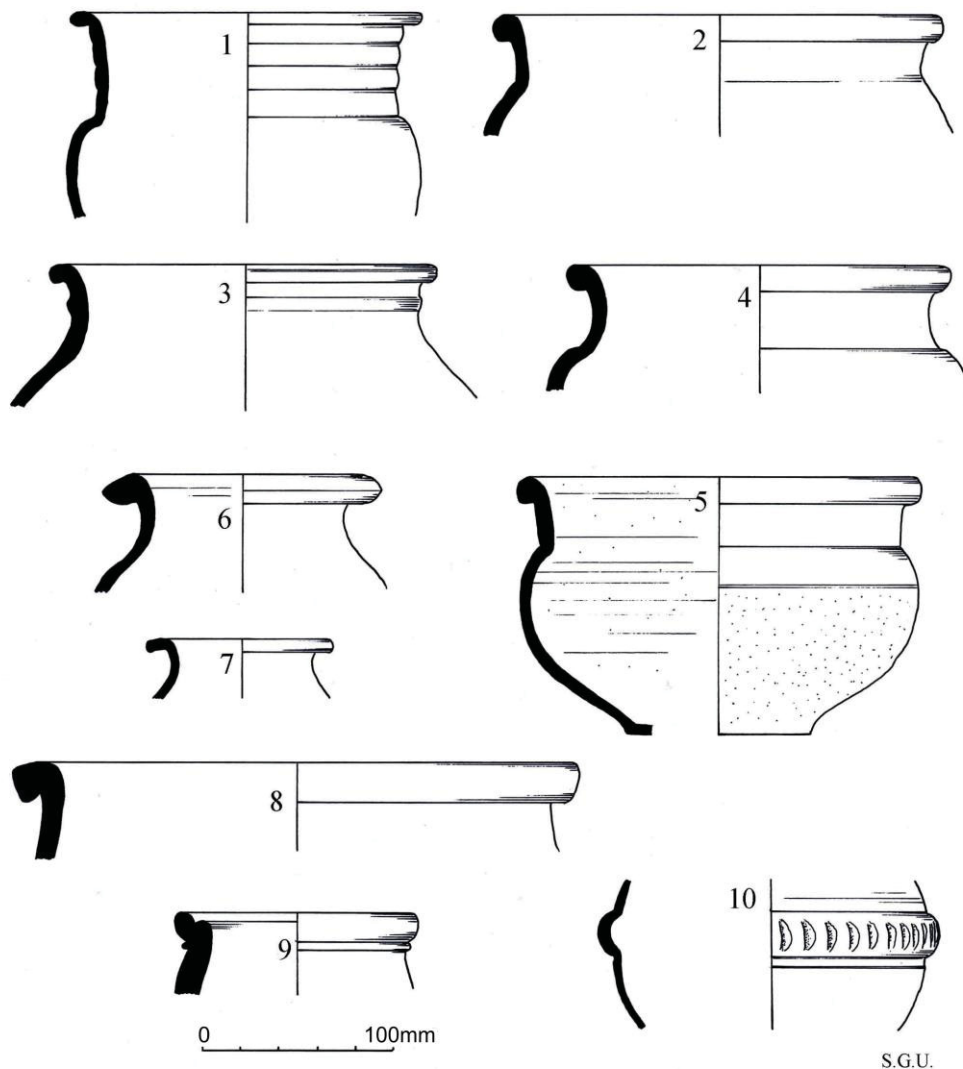

Fig 2.1: Roman pottery: grey ware jars (1-10)

Grey ware dishes and beakers (Fig 2.2)

- 11 CR21/18/21, slight sandy feel to surfaces (see Perrin 1999, fig 58) (BNL86 B1) Surfacing of yard 1 Period 3/4
- 12 CR20/18/21, NL73 B3) from within the concrete flooring of the bath suite, see section D-E, Period 4
- 13 CR19/18/19, (BNL86 E29) Surfacing of yard 1, Period 3/4
- 14 CR21/20,21, very well fired vessel (BNL E6) fill of ditch 6, see sections Q-R 1-3, Period 4/5
- 15 CR19/18/19, waster (BNL85 C10) from the fill of gully 36 (see Fig 2), Period 5
- 16 CR19/20/19, (BNL73 B2) from destruction layer over bath, Period 6
- 17 CR22/21/22, (BNL73 B9) from pit III, see section C-D Period 6
- 18 CR22/21/22, (BNL73 A7) from pit III, Period 6
- 19 CR 21/ 21/21, 22, slightly burnished outer surface (BNL73 A15) from pit III, see section B-C, Period 6
- 20 CR20/18/20, Small sherd of grey ware with six barbotine dots forming a rosette (BNL73 A6) from Pit III. The sherd comes from a late 4th century context but possibly comes from a poppy-headed beaker form of the early 2nd century (see Perrin 1999, fig 56, 1-2).
- 21 CR20/18/21, body sherd with stamped decoration, (BNL73 B 20) from the mason's trench of the bath suite (Period 4), see section D-E, although the vessel from which the sherd comes is from the early 2nd century.
- 22 CR20/18/21, (BNL1985 D 16) from ditch 16, see section K-L, body sherd from a beaker or jar with a perforation on what appears to have been the shoulder of the vessel. Period 1
- 23 CR18/18/20, (BNL73 B 2) from the destruction layer over the bath suite. Body sherd of a beaker(?) with rouletted decoration in two bands separated by indentations. Period 6 context but grey ware vessels with rouletted decoration appears to be more typically late 2nd/early 3rd century.

A ROMAN FARMSTEAD AT NORTH LODGE, BARNWELL

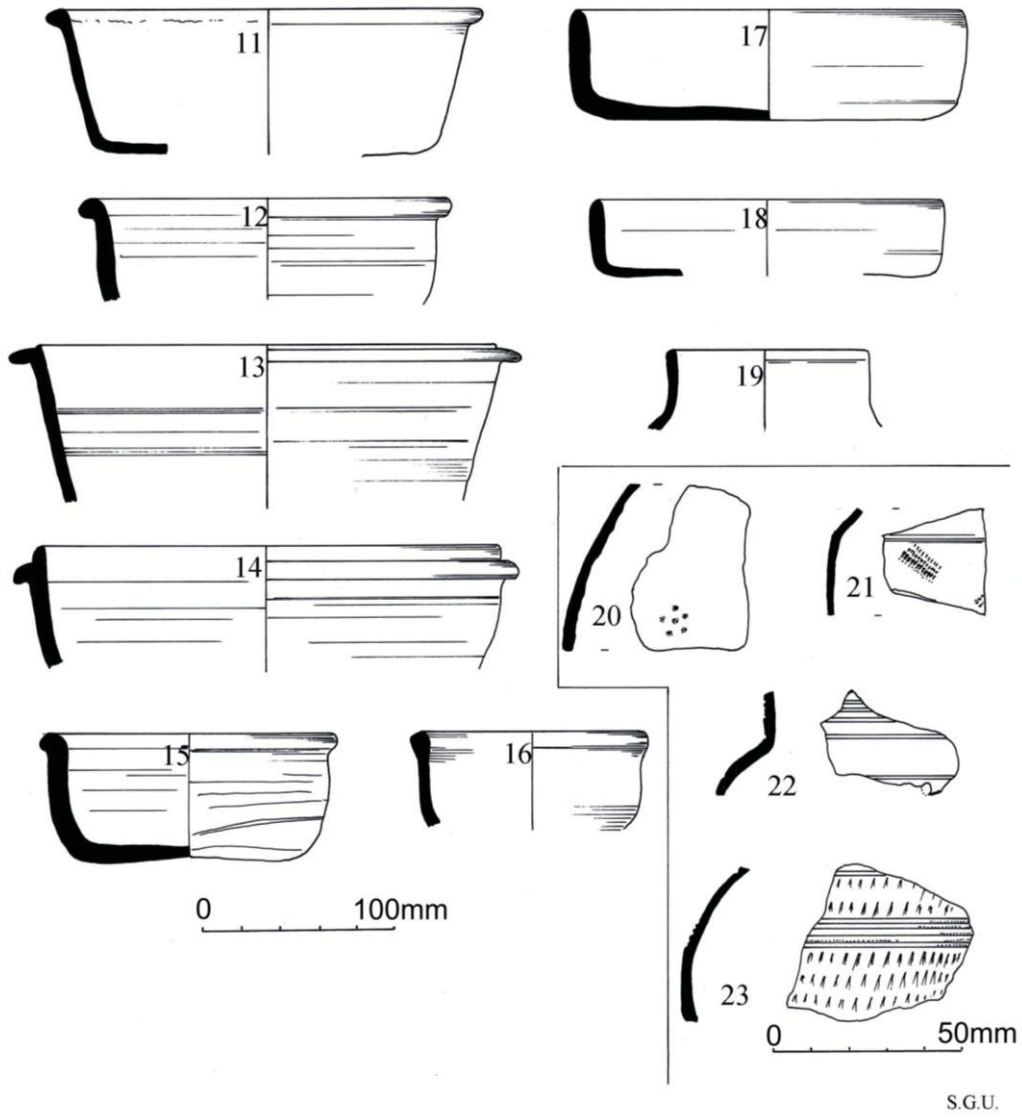

Fig 2.2: Roman pottery; grey ware dishes and beakers (11-23)

Colour coated Jars (Fig 2.3)

- 24 CR12/6/10, (BNL85 C1) from gully 36, Period 5 (See Perrin 1999, fig 65, 280-282 for similar vessels from 4th century contexts.
- 25 CR 9/27/9, (BNL73 A15) from pit III, see section B-C, Period 6
- 26 CR11/10/11, (BNL73 A5) from pit III, see section C-D, Period 6
- 27 CR9/26/9, (BNL73 A9) from pit III, see section C-D, Period 6
- 28 CR10/14/10, (BNL86 C8) from top of gully 36, Period 5/6
- 29 CR 9/26/9, (BNL86 C) from surfacing to east of wall and gully 36, Period 5
- 30 CR 14/26/14, (BNL86 E29) from surfacing within yard 1, Period 3/4

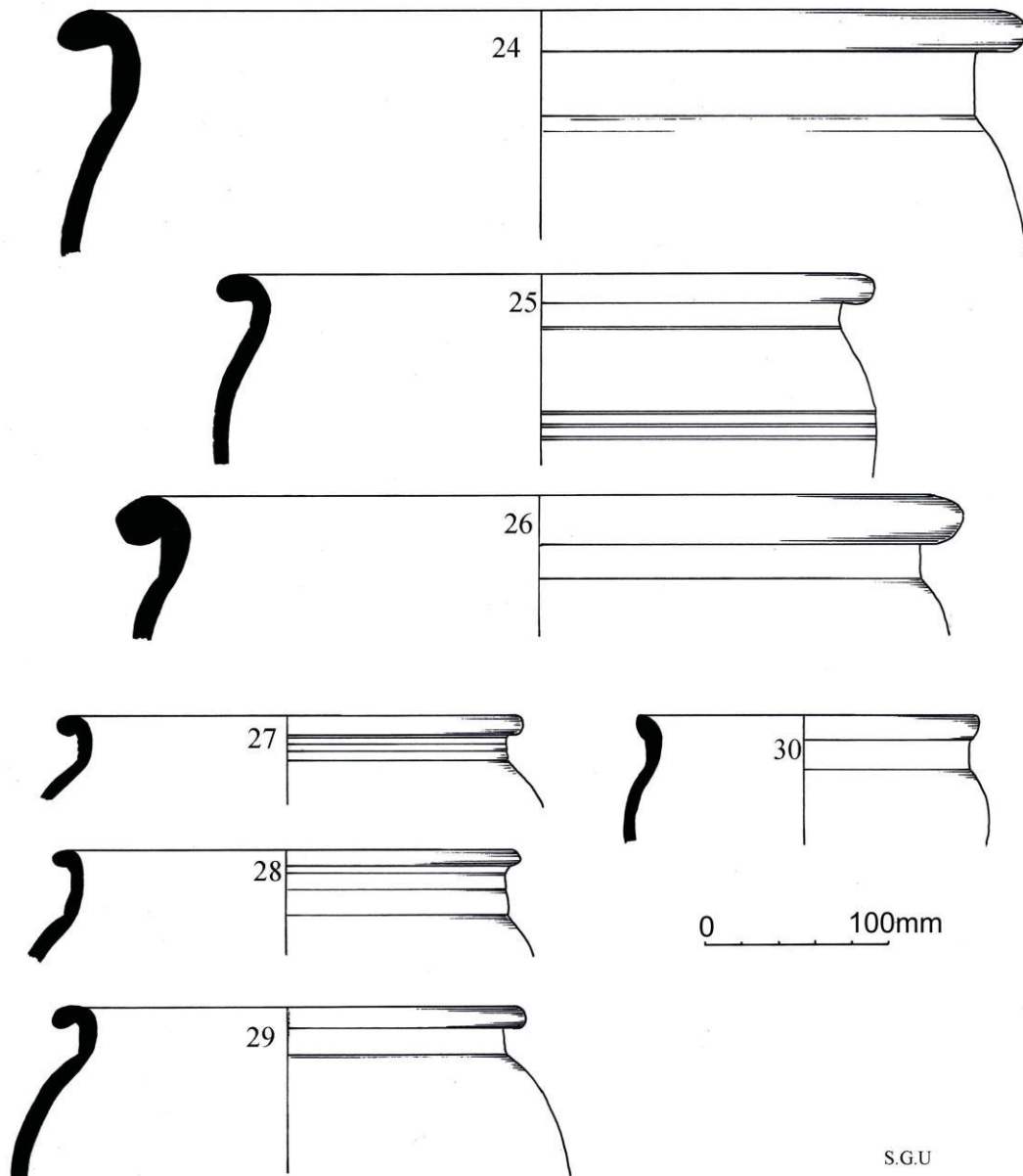

Fig 2.3: Roman pottery: colour coated Jars (24-30)

Colour coated dishes and bowls (Fig 2.4)

- 31 CR13/5/13, 9, imitation samian form 38, (see Perrin 1999, fig 63, 245-7) (BNL85 C5) from surfacing to east of wall and gully 36, Period 5
- 32 CR8/26/8, imitation form 38, (as 31 above) (BNL73, A7), from pit III, Period 6
- 33 CR17/26/17, plain rimmed dish, (BNL85 D13), from pit I, see section E-F, Period 5/6
- 34 CR9, 12/26/12, 9, 8, (BNL73 A16) from pit III, Period 4/5
- 35 CR10/26/10, imitation samian form 31, complete profile of vessel, (BNL85 D15) from pit 1, see section E-F, Period 5
- 36 CR13/26/12, 16,, as 35 above, (BNL85 C1) from gully 36, Period 5
- 37 CR10, 13//10/20/10//13, 12, as 35-36 above, (BNL73, A12) from Pit III, Period 4/5
- 38 CR 17, 10/26/13/17, as 35-37 above but with thicker rim, (BNL73, A9) from pit III, see section B-C, Period 6
- 39 CR13/26/13, as 35-38 above, (BNL73 A9), from pit III, see section B-C, Period 6
- 40 CR11/26/12, 11, straight sided flanged bowl, for close parallels see Perrin 1999, fig 64, 258-261, (BNL73 B2) from the destruction layer over the bath area, see section D-E, Period 6
- 41 CR17/26/17, as above, (BNL86 E6) from the fill of ditch 6, Period 4/5
- 42 CR11/26/11, as above, (BNL86 E3) from fill of ditch F3 to west of Yard 1, Period 4/5
- 43 CR16/26/16, as above, (BNL73 B3) from flooring within bath suite, see section D-E, Period 4
- 44 CR17/26/17, as above, see Perrin 1999 fig 64, 258-260. (BNL73 A12), from Pit III, Period 6

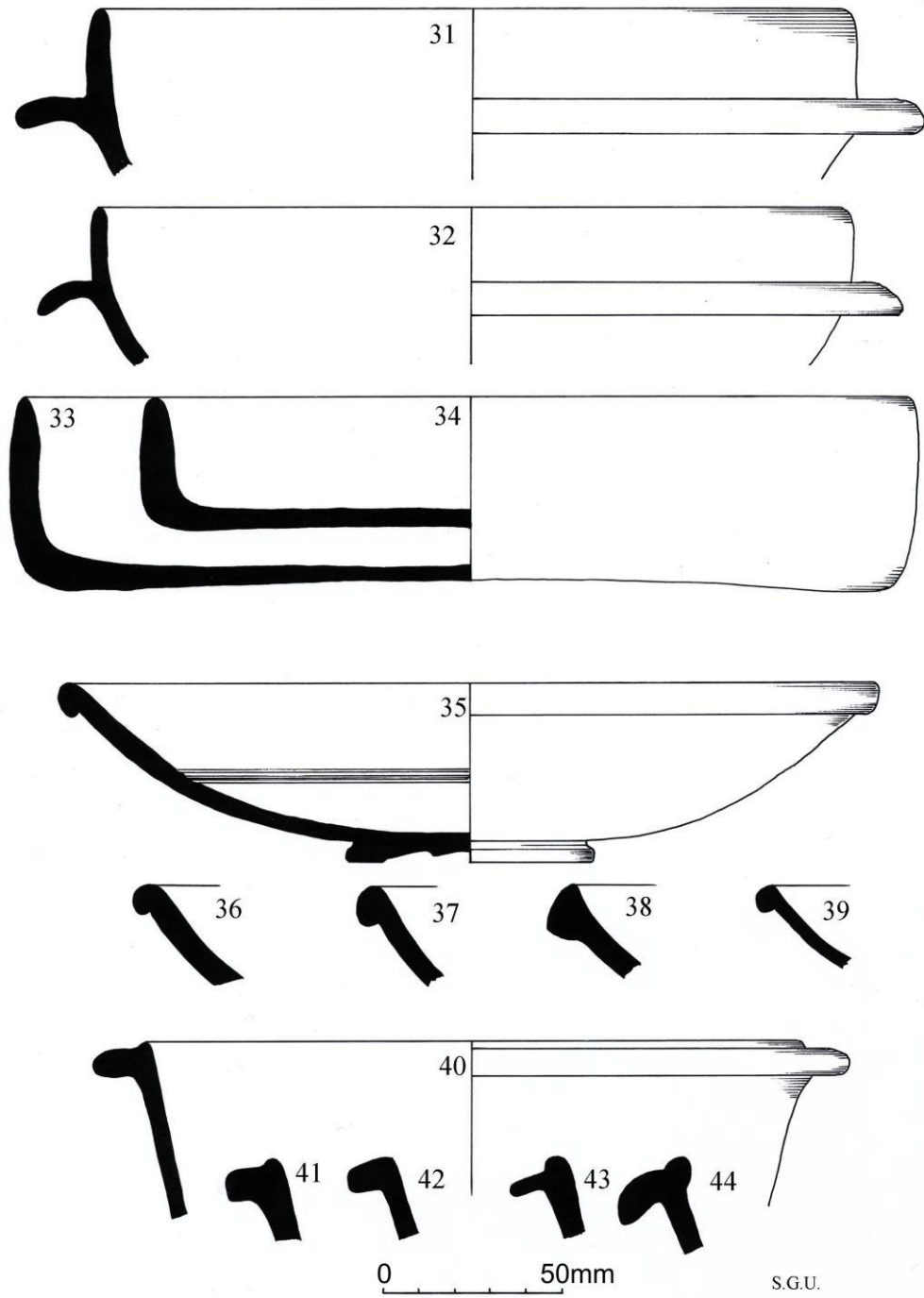

Fig 2.4: Roman pottery: colour coated dishes and bowls (31-44)

Four complete colour coated vessels from stone-lined cist (F66) (Figs 2.5 and 24)

- 45 CR9/26/9, complete vessel with two handles and a wide mouth; decorated with two zones of rouletting and over-painted in white with a running scroll. This form of vessel is similar to ones from the Stibbington well which have both two and three handles (Perrin 2008, figs 28-29, 183-6) and are dated to the late 4th/early 5th century.
- 46 CR8/26/8, complete vessel, flask with an indented double band of decoration on the shoulder and a wide base. Similar vessels are identified from Stibbington, with and without decoration or over-painting (Perrin 2008, fig 22, 93-98) and a vessel of similar form is in the Museum collection at Peterborough (Howe *et al* 1980, fig 6, 69) - all of these vessels are dated to the later part of the 4th century.
- 47 CR13/26/13, complete vessel, two-handled flask or bottle similar to a vessel from Stibbington (Perrin 2008, 22, 89) and one in the Peterborough Museum collection (Howe *et al* 1980, fig 6, 67) both dated to the 4th century.
- 48 CR12/26/12, complete vessel, flanged bowl, similar vessels come from Kiln W at Stibbington (Perrin 2008, fig 19, 42-49; see also Perrin 1999, fig 64, 257-260), late 4th century.

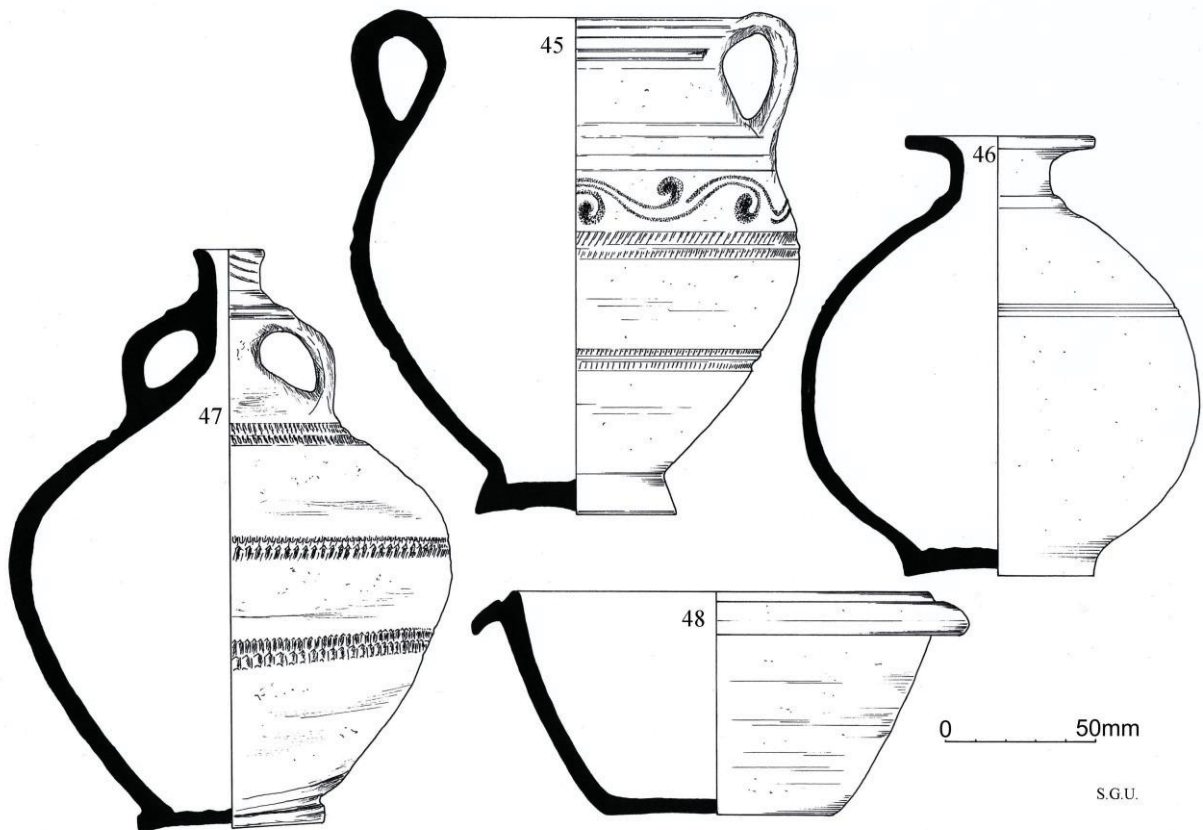

Fig 2.5: Four complete colour coated vessels from stone-lined cist (F66)

Colour coated beakers (Fig 2.6)

- 49 CR13/9/23, (BNL73 A16) from the filling of Pit III, Period 5
- 50 CR9/7/10, (BNL85 C5) from late surfacing to east of gully 36, Period 5
- 51 CR12/26/12, Cornice-rimmed beaker, (BNL86 E2) from surfacing of gate between Yards 1 and 2, Period 2
- 52 CR17/19/17, Cornice-rimmed beaker, (BNL85 D2) from fill of Ditch 1, see section K-L, Period 3
- 53 CR4/18/16, Cornice-rimmed beaker, (BNL85 D2), from fill of Ditch 1, see section K-L, Period 3
- 54 CR17/16/17, Beaker rim with coarse sandy surface texture and rouletting above decorative lines. (BNL73 B9) from makeup of flooring within bath suite, Period 4
- 55 CR 9/26/13, Scaled beaker, (BNL86 E2) from the surfacing of gate between Yards 1 & 2, (see Perrin 1999, fig 60, 122), Period 2
- 56 CR9/9/22, under-slipped with white barbotine decoration, (BNL73 A16) from fill of pit III- this sherd comes from a late context (Period 5/6) but is probably best dated to the late 2nd-early 3rd century (see Howe *et al* 1980 fig 5, 47-50).
- 57 CR21/7/21, Body sherd underslipped with pink/orange over-painting, (BNL86 D15) from lower fill of Pit 1, see section E-F, Period 5 context but the sherd is best dated to the late 2nd- early 3rd century (see Howe *et al* 1980 fig 5, 47-50).
- 58 CR 13/13/23, sherd from the body of a beaker under-slipped and then over-painted in pink, with additional rouletted decoration, very well fired. (BNL86 D15) from lower fill of Pit 1, see section E-F, Period 5 context but the sherd is best dated to the late 2nd-early 3rd century (see Howe *et al* 1980 fig 5, 47-50).
- 59 CR14/14/14, sherds of a beaker with bulbous body decorated with barbotine scrolls- (BNL86 E6) from fill of Ditch 6, see sections Q-R/1-3. From a context within periods 4/5 but the vessel is probably best dated to the mid-2nd to early 3rd centuries.
- 60 CR 14/14/17, Body sherd under-slipped and with barbotine markings and rouletting band, (BNL73 B2) from destruction layer over bath suite. The sherd comes from a Period 6 context but is best dated to the mid-2nd to early 3rd centuries.
- 61 CR22/9/2, Body sherd with under slip and barbotine and over painted scroll design, (BNL73 A13) from Pit III. The sherd comes from a Period 6 context but is best dated to the mid-2nd to early 3rd centuries.
- 62 CR12//5,18//22, Body sherd with with slip over barbotine scroll decoration. (BNL86 E2) from area of gate between yards 1 and 2, Periods 3-5, the sherd is similar to that found on pedestal beakers of the later 2nd century (see Howe *et al* 1980, fig 3, 31).
- 63 CR24/20/14,20, plain rimmed beaker with light brown/yellow over painted decoration. This vessel appears to be an import into the area and not made within the Nene Valley, perhaps from the area of the upper Nene valley? (BNL87 E +)
- 64 CR13/26/17, probably from a pentice moulded beaker (see Howe *et al* 1980, fig 5, 55-57) (BNL73 A12), from pit III, Period 6
- 65 CR14//14,20,14//14, A rim that may be developed from cornice rimmed vessels with very shallow rouletting to the shoulder, (BNL85 D4) from lower fill of Pit II, Period 4/5

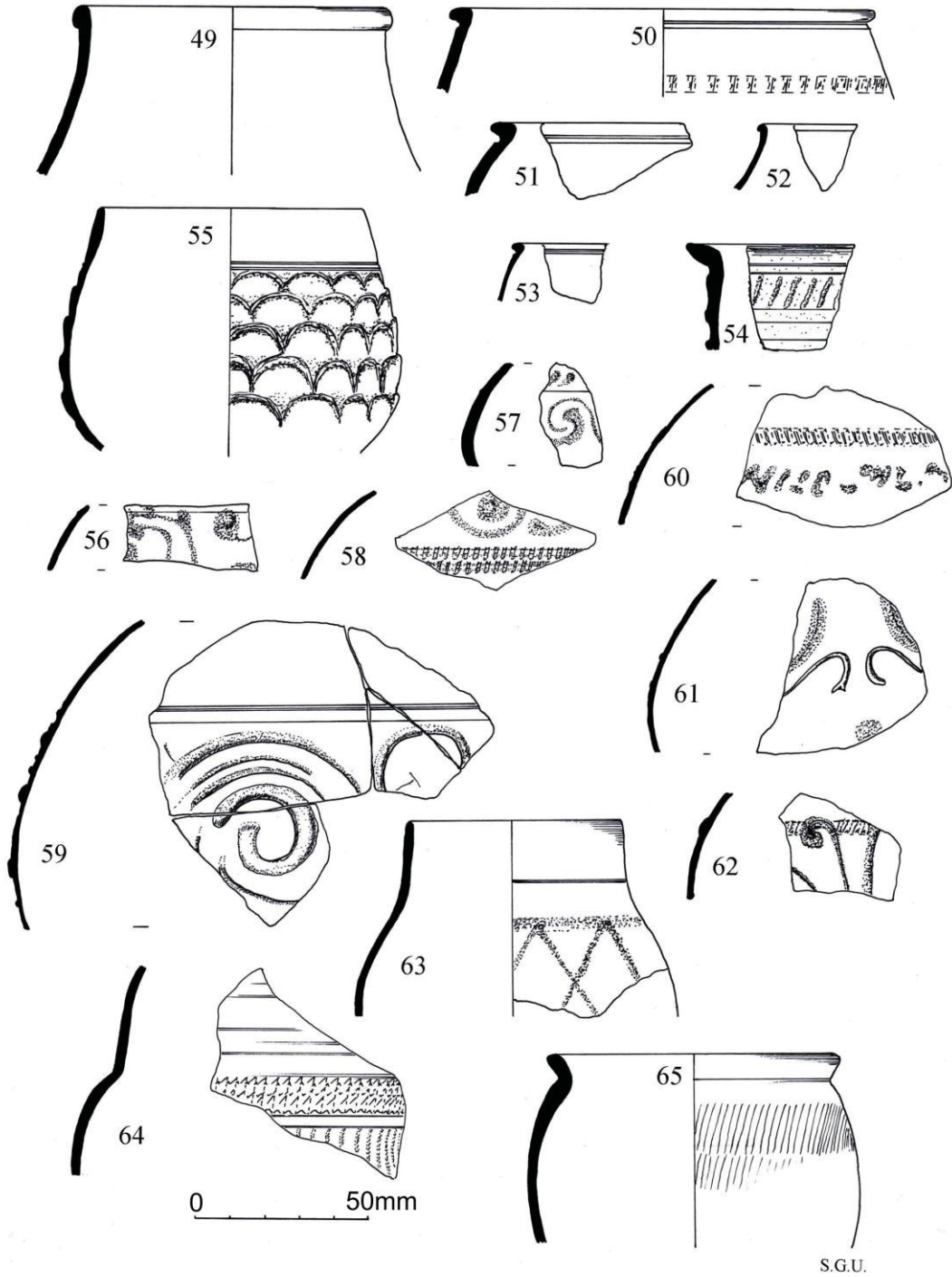

Fig 2.6: Roman pottery: colour coated beakers (49-65)

Castor boxes (Fig 2.7, 66-71)

Fifteen fragments of Castor boxes come from the site, most from late deposits within Periods 5 and 6. No 69 appears to be one of the earliest on the site stratigraphically, dated to the 3rd century; the others are all late 3rd or early 4th century in date (see Perrin 1999, 98-100).

- 66 CR17/26/12,13, (BNL73 B2) Lid of Castor Box, from the destruction layer over the bath, Period 6
- 67 CR17/5/11,12, Lid of Castor Box, (BNL85 C1), from gully 36, Period 5
- 68 CR16/26/16, Lid of Castor Box, (BNL73 A12), from Pit III, period 6
- 69 CR24/5/24,10, (BNL86 E6), from Ditch 6, see sections Q-R/1-3, Period 3/5
- 70 CR8/26/8, (BNL85 D15), from Pit I, see section E-F, Period 5/6
- 71 CR10/26/10,12, (BNL73 A5), Period 6

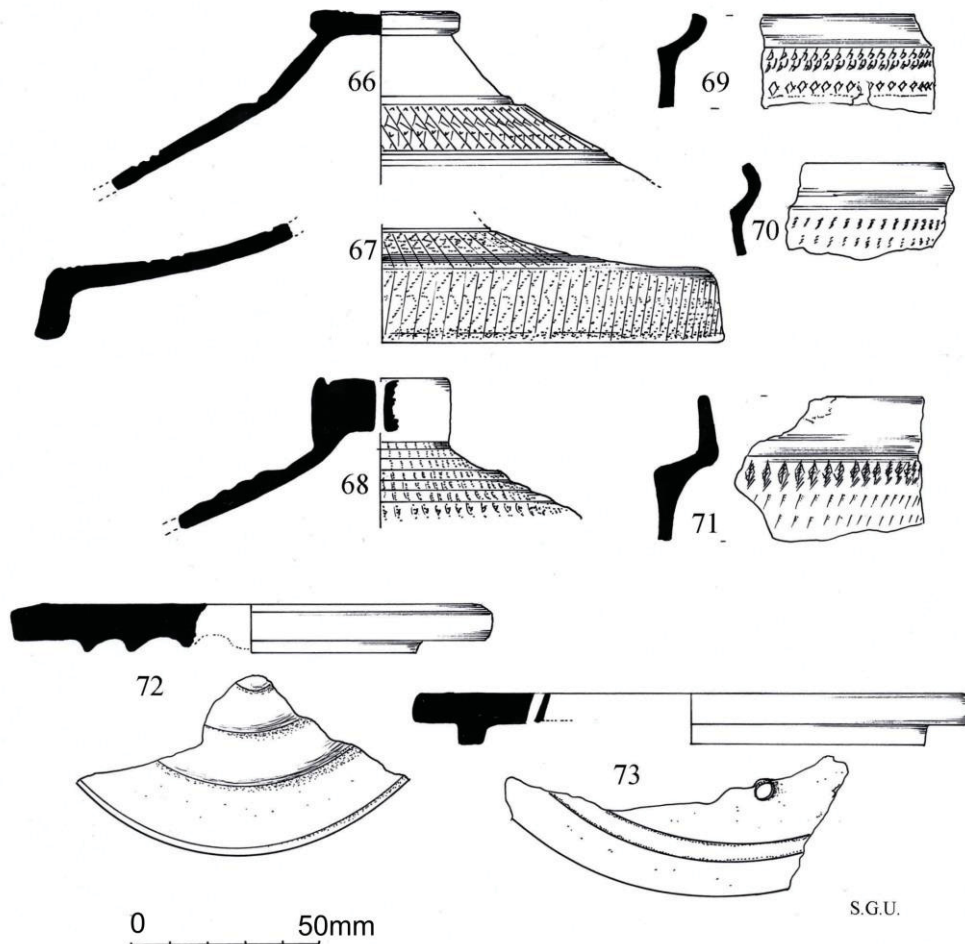

Fig 2.7: Roman pottery: Castor boxes (66-71) Cheese presses (72-73)

Cheese presses (Fig 2.7, 72-73)

Three fragments of cheese press were recovered, of which two are illustrated.

- 72 CR5//5/19/5//5, Similar to an example from Orton Hall Farm which was dated to the early 4th century (Perrin 1996, fig 96, 393), (BNL86 C4) from packing F17 at the north-eastern end of the bath suite, Period 4
- 73 CR18/18/18, (BNL85 C3), from surface of yard 3, Period 4

Cream Ware and colour-coated bowls and dishes with over painting (Fig 2.8)

- 74 CR6//6,5,6//6, Large bowl in cream ware with over painted reddish brown decoration, similar to a vessel from Duston dated to the 3rd century (Woods 1970, fig 38, 268; also Woods and Hastings 1984) (BNL73 B2) from the destruction layer over the bath suite, Period 6.
- 75 CR 8/26/8, Large dish with flanged rim and over painted decoration in white slip to the rim (BNL73 A 5), from Pit III, see section C-D, Period 6
76. CR 10/26/10, Large dish with flanged rim and over painted in white slip (BNL73 A1), from Pit III, see section B-C, Period 6
- 77 CR12/26/11,10, Imitation samian form 36 with white painted decoration, (BNL73 A6), Period 6
- 78 CR 16/8/16, Bowl with over painted decoration in orange slip, (BNL85 C3) from surfacing contained within Ditch 14, Period 3
- 79 CR9/26/9, Bowl with over painted white decoration, (See Perrin 2008, fig 20, 68-9), (BNL73 A5) from Pit III, see section C-D, Period 6
- 80 CR17/26/17, Imitation samian form 31(?) with light brown over painted decoration, (BNL 85 C5) from stone packing to north-east of baths suite, Period 5
- 81 CR23/26/23,17, Bowl or jar with white painted decoration to the rim, (BNL73 A20), see section A-B, Period 6
- 82 CR13/10/13, Bowl with lustrous finish and orange paint applied to rim. For a similar vessel dated to the 4th century see Howe *et al* 1980 fig 7, 86, (BNL73 A7), Period 6
- 83 CR10/26/10, base of bowl with white cross painted on the inside of the base. (BNL73 A7), Period 6

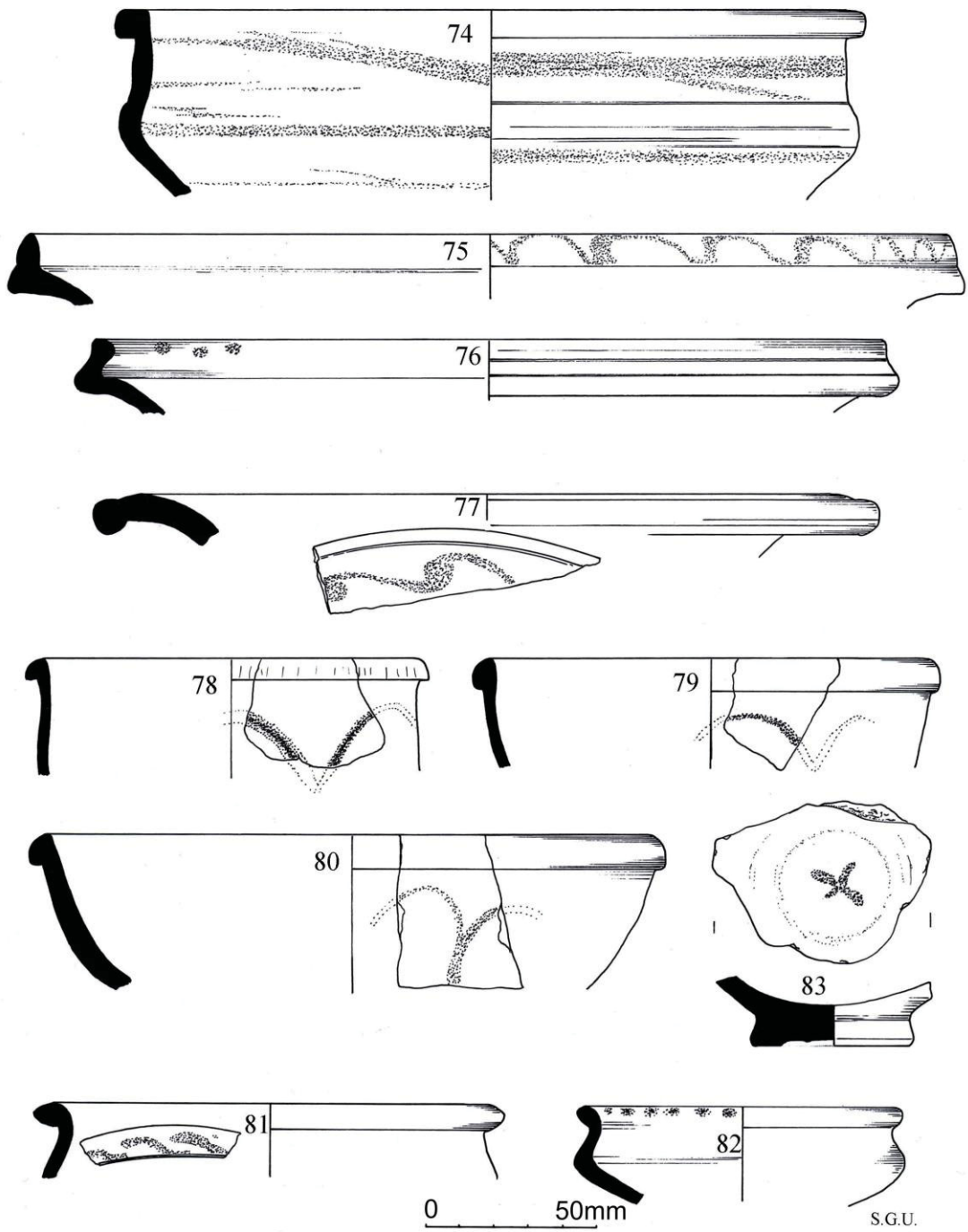

Fig 2.8: Cream Ware and colour-coated bowls and dishes with over painting

Bowls and dishes with Roman forms but in sand tempered fabrics and with black finishes
(Fig 2.9, 84-90)

Nene Valley Post-Industrial Roman Pottery (NVPIRP) is characterised by its black fabric which is often sand-tempered with the exterior surfaces of the vessels having a black fumed exterior which is sometimes burnished (Upex 2008, 94). The repertoire of vessels is limited to flanged bowls and pie dishes, some of which have burnished lattice decoration on the inside of their bases. This limited series of vessels at Barnwell is matched by a similar limited range of products at other sites in the Nene valley (Upex 2008, 93-94; Upex 1993). The vessels from Barnwell come exclusively from Period 6. This late production may represent a last phase of pottery making in the Nene valley adopting entirely functional and basic Roman forms but using poorer quality clays, to which sand has been added. All of the vessels appear to have been fired in reduced atmospheres at low temperatures and this may add to the picture of a decline in large Nene Valley kilns, with potters firing small loads in less well made kilns on either a self-sufficient basis or for a much reduced local market. Such production may represent the very last pottery to be made within the Nene Valley in the Roman period and although absent from the kiln site at Stibbington (Upex 2008a), the date range from the well stratified deposits at Haddon suggest that production could have extended well into the 5th century (Upex 1993).

- 84 CR28/22/28, (BNL73 B 2) from destruction layer over bath suite, see section D-E Period 6
- 85 CR28/22/28, Slight burnishing to exterior and interior of vessel. (BNL85 C1) from gully 37, Period 6
- 86 CR28/22/28, Rim of bowl with coarse gritty fabric and finish, (BNL73 A3), see section B-C, Period 6
- 87 CR28/22/28, Flanged bowl, burnished on exterior, (BNL86 C21) from gully 37, Period 6
- 88 CR 21/17/28, shallow dish with beaded (?) rim, (BNL85 C2) from destruction layer over bath suite, see section D-E, Period 6
- 89 CR28/21/28, Flanged bowl similar to 87 above, coarse gritting fabric and finish, (BNL86 D 3) Top fill of Pit I, Period 6
- 90 CR28/21,22,21/28, Flanged bowl with slight burnishing to inner surface, very coarse gritty fabric and finish, (BNL73 A8), from fill of Pit III, see section B-C, Period 6

Flagons in Cream Ware (Fig 2.9, 91-92)

Four flagon profiles were recovered of which two are illustrated. All have very thin walls and globular bodies but it is uncertain if they had one or two handles. Little is known about the typology of flagon development at present. Those illustrated from Chesterton come from mid-2nd to late 3rd century contexts and have single handles but with thickish walls and are less globular than the Barnwell examples (Perrin 1999, fig 66, 312-314). An example from Orton Hall Farm with one handle and thin walls is dated to the mid to late 1st century (Perrin 1996, fig 86, 161) and a fragment, in similar fabric, comes from Orton Longueville (Rollo and Wild 2001, fig 41, 159) and is dated to the 1st century. Early flagons from the Longthorpe fortress have wider mouths (Dannell 1987, fig 38), although their forms are more globular and similar to the Barnwell examples. Both illustrated flagons from Barnwell come from deposits which fall into Period I which is dated to the late 1st or early 2nd century – although the flagons may be residual to this context, the large size of the sherds may point against this. The problem however remains as to where such products were produced.

- 91 CR6/5/6, Thin walled flagon with one (?) handle in well fired fabric and smooth surface finish. (BNL85 D18) from gully 18, Period 1
- 92 CR6/5/6, as 90 above but with a tall, cylindrical neck, (BNL85 D18) from gully 18, Period 1

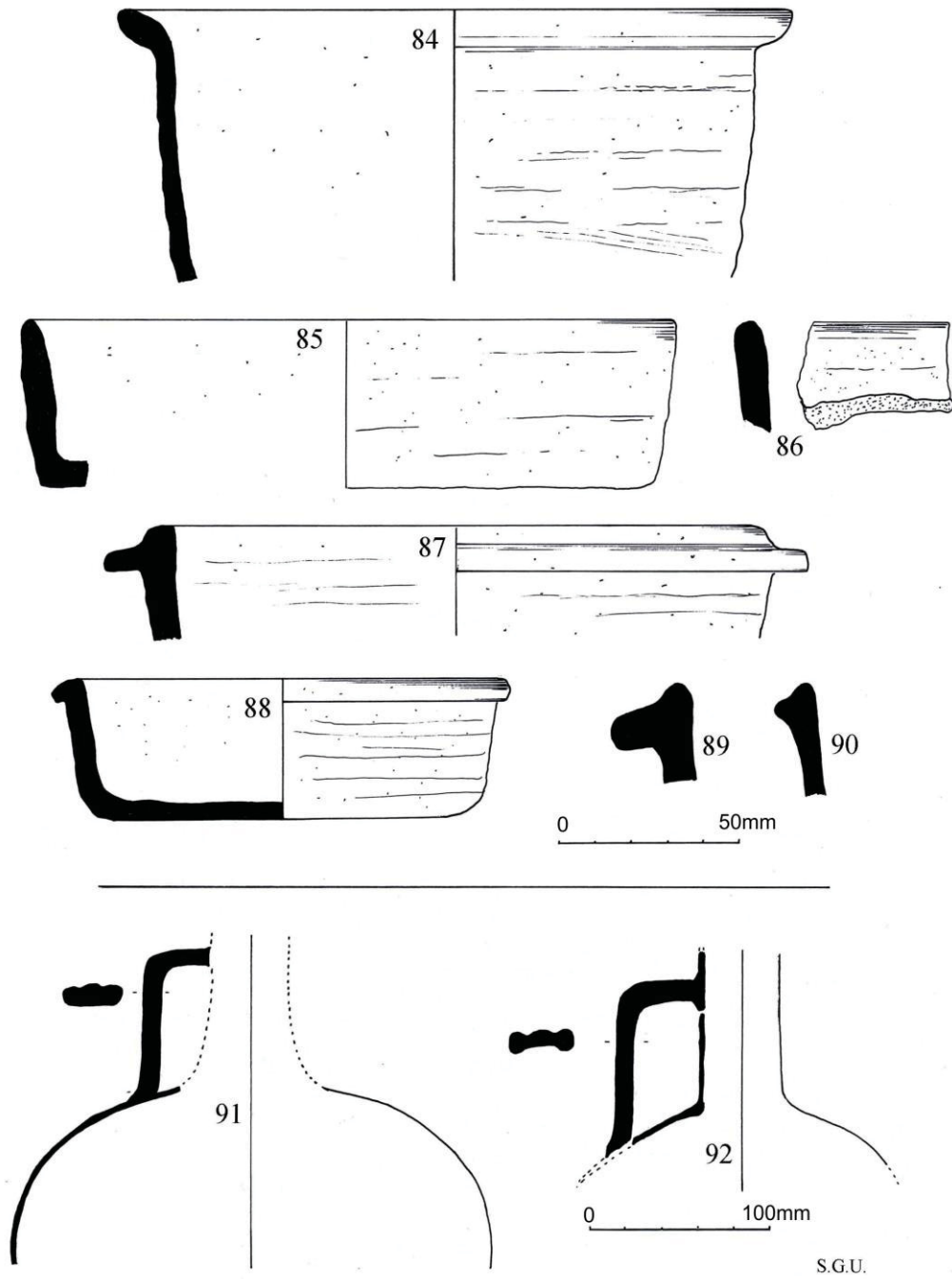

Fig 2.9: bowls and dishes (84-90), Flagons (91-92)

Mortaria (Fig 2.10)

References to fabrics are those outlined by Hartley (1996, 199).

- 93 Cream orange fabric (Fabric 4) with small white and some orange grit inclusions and cream/orange finish. No trituration grit present, and from either a N/V kiln site or one from the Mancetter-Hartshill area. (BNL86, E 2), from the surfacing within yard 1, similar to a vessel from Orton Hall Farm which is dated to the 3rd century or later (Perrin and Hartley 1996, fig 115, 41) which would fit the date context from Barnwell, Period 3/4
- 94 Fabric and finish as 93. No trituration grit present. Finger-moulded spout. (BNL73, B2), from the destruction layer over the bath suite, Period 6
- 95 Fabric 7, cream paste with a pink core and white quartz inclusion. (BNL73, A10), from Pit II, Period 5
- 96 N/V Fabric 1, cream with traces of brown /orange coat. Black angular grit, for a similar vessel see Hartley and Perrin 1999, fig 78, M48, dated to the late 3rd-early 4th century) (BNL86, E 29), Period 3/4
- 97 N/V Fabric 1, as 96 above, but without grit, beaded rim. (BNL85 C5), from surfaced area to north-east of baths suite, Period 5
- 98 NV Fabric 2. Beaded rim, finger-moulded spout, (BNL86 E29), Period 4/5)
- 99 N/V Fabric 2. beaded rim -black angular grit, possibly from Kiln W at Stibbington (see Perrin 2008, fig 23, 119-121) (Part of this vessel was found in pit III, (BNL73 A25) and part over the demolished bath building (BNL73 B2), see section D-E, Period 6
- 100 White/cream fabric, with red and black angular grit. Red/brown paint applied to external rim, Oxford White Ware (OXMO) (see Young 1977, form 142; Tyers 1996, 129; Tomber and Dore, 1989, 174), (BNL86 D 15), from lower fill of Pit I, Period 5

Ten body sherds (not illustrated) with red-brown trituration grit which probably belong to fabric 7 indicate imports from the Mancetter-Hartshill area (see Hartley 1996, 199)

Four body sherds (not illustrated) of Oxford Red/Brown Slipped Ware (OXF RS) mortaria were also recovered belonging to Young's forms 97-100 (Young 1977; Tyers 1996, 175-178). All four pieces belong to the 4th century and form, along with no 100 and the imported Oxford coarse wares (see below), a typical assemblage on Nene Valley rural sites (see Perrin 1996, 164).

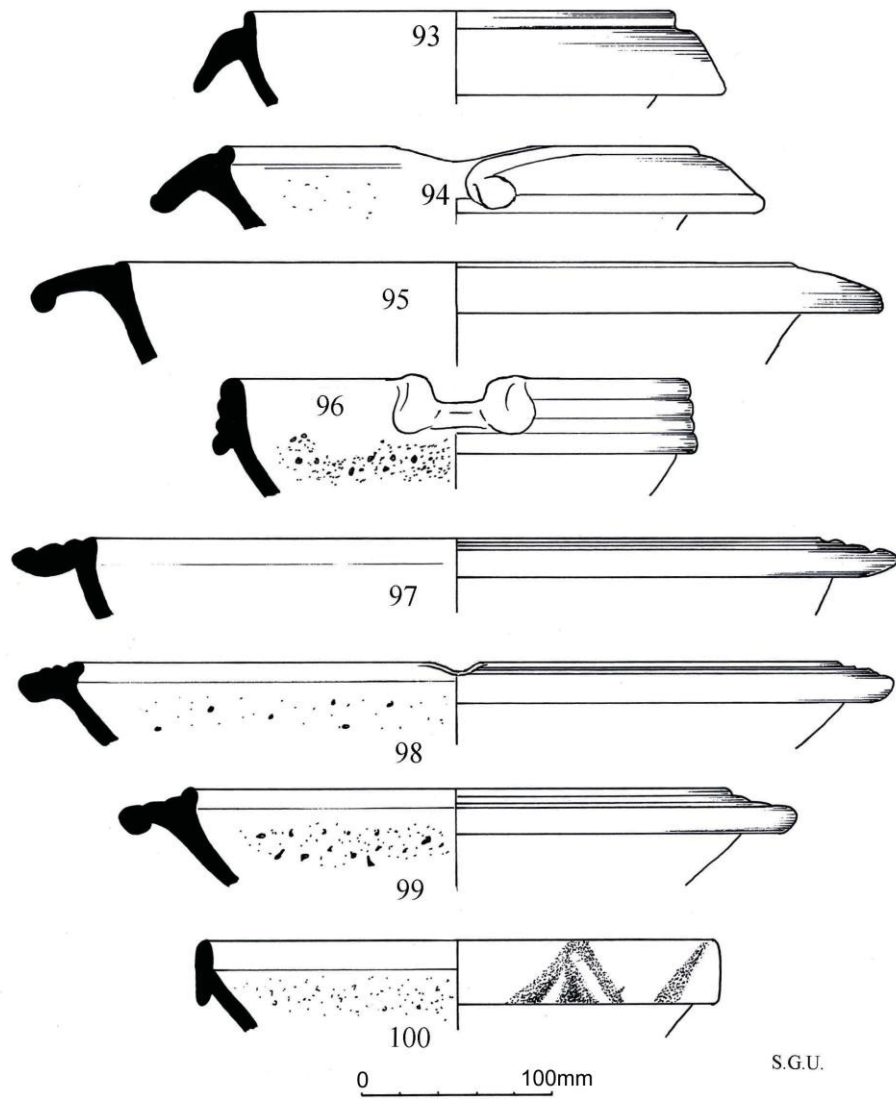

Fig 2.10: Roman pottery: mortaria (93-100)

Roman shell-gritted wares (Fig 2.11, 101-112)

A large proportion (38%) of the shell-gritted wares from Barnwell had lid seats which seems to be a high proportion of all RSG vessels when compared to other Nene valley sites (see Perrin 1996; Perrin 1999; Hinman 2003 & French 1994).

Jars with lid seats

- 101 CR16/7/16,10, (BNL73 B2), from destruction over bath, Period 6
- 102 CR 7,16,10/18/16, (BNL73 B2) context as for 101, Period 6
- 103 CR10/20/10, (BNL73 A12) from Pit III, Period 6
- 104 CR18,16/18/7, (BNL73 B2) from destruction layer over bath suite, Period 6
- 105 CR14,21/21/28, (BNL 73 A12) from Pit III, Period 6
- 106 CR17/22,15,22/22, (BNL73, B20) from the mason's trench of the bath suite, see section D-E, Period 4
- 107 CR26/26,18,20/20, (BNL73 B20) from the mason's trench of bath suite, see section D-E, Period 4

Jars with plain rims

- 108 CR9/21/18,15, Flanged bowl, (BNL73 A12), from the fill of pit III, Period 6
- 109 CR15/18/15, wide mouthed storage jar (BNL73 B2) destruction layer over bath suite, Period 6
- 110 CR7/15/7, (BNL85 D14) fill of ditch 16, Period 1
- 111 CR21,14/20/21, (BNL73 B20), from the mason's trench of bath suite, see section D-E, Period 4
- 112 CR16/16/10,16, (BNL73 B2) destruction layer over bath suite, Period 6

Lids

Lids are known from several dated deposits within the Nene valley but their forms appear to be similar in all cases (see Rollo and Wild 2001, fig 43, 195; Cameron 1996, fig 173, 302)

- 113 CR21,16/16/21,16, (BNL73 A2), from the top fills of Pit III, Period 6
- 114 CR21/21/21, (BNL73 A16), from pit III, Period 5-6

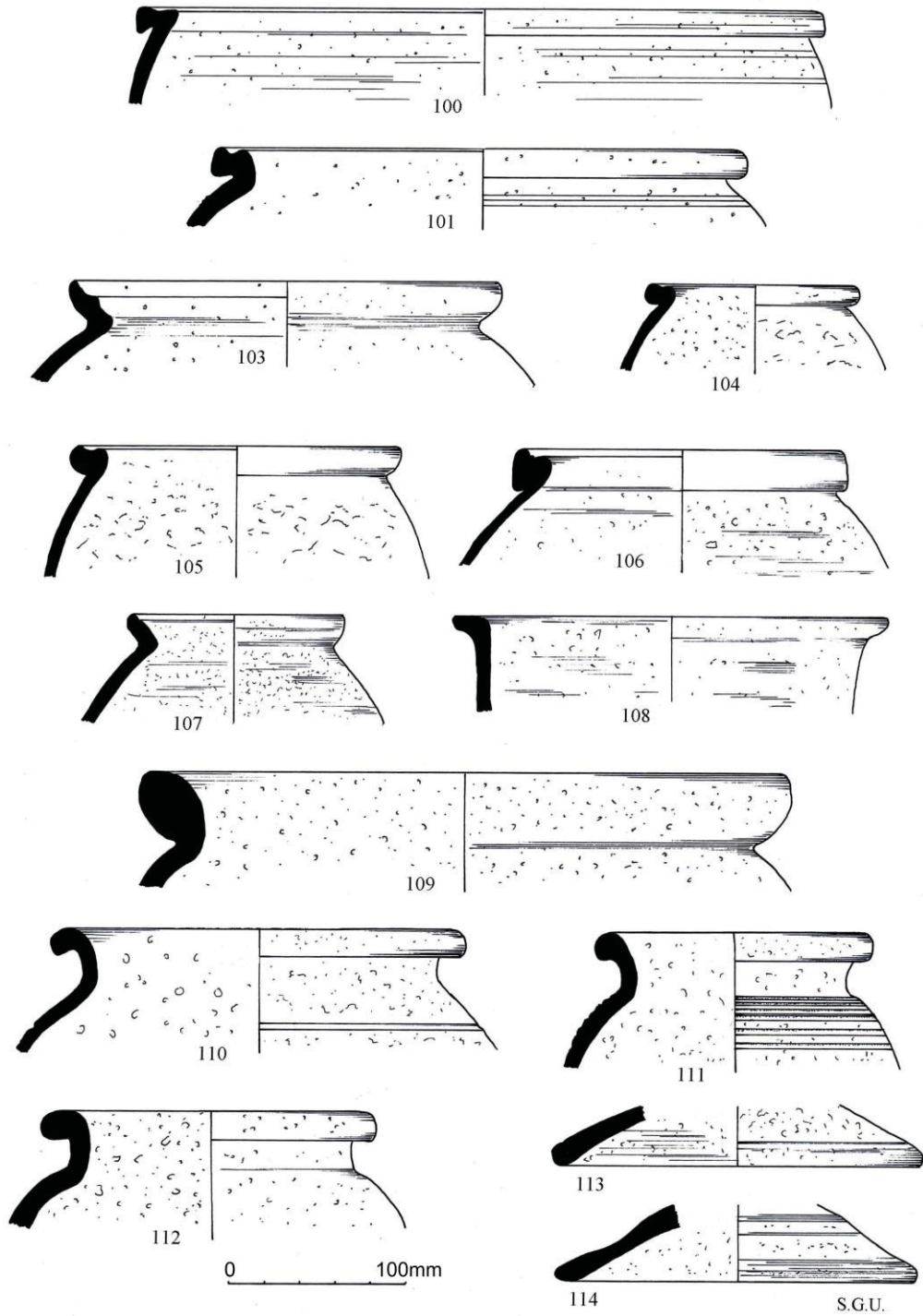

Fig 2.11: Roman pottery: Roman shell-gritted wares (101-114)

Oxfordshire wares (Fig 2.12)

Twenty-three fragments of Oxford Red/Brown Slipped Ware (OXF RS) came from the site, of which nineteen were body sherds without decoration and four were rim sherds, with two illustrated (115 & 116). Four sherds of Oxford Red/Brown Slipped Ware mortaria (OXF RS) were also found, one of which is illustrated (no 100). All sherds were found in 4th century contexts or residual later deposits.

- 115 Rim of jar with rouletting decoration (BNL86 C17), from wall foundation next to gully 36, Period 5
- 116 Jar with scored decoration, (BNL73 A1), Pit III, Period 6

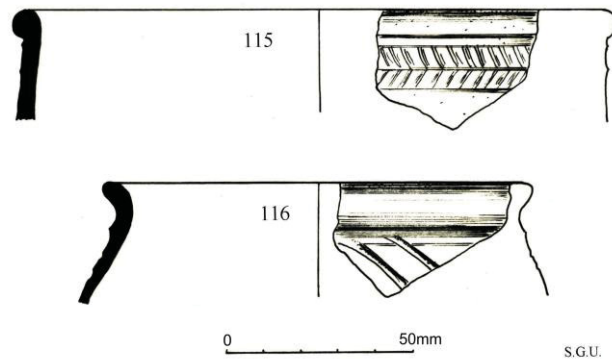

Fig 2.12: Roman pottery: Oxfordshire wares

Other finds

The coins by Philippa Walton

The excavations produced a small assemblage of 40 coins. Although the majority of coins were worn and corroded, it was possible to assign 31 to a Reece period and the remaining nine broadly to the 3rd or 4th centuries AD. Although the earliest coin recovered is a *sestertius* of Trajan, the assemblage is dominated by late 3rd-century radiates and 4th-century *nummi*. A catalogue of the coins is presented in Appendix 2.

An interpretation of the assemblage

The coins from Barnwell Lodge represent the standard range of issues one would expect from a site occupied in the late 3rd and early 4th centuries. There are a mixture of barbarous and official radiates, whilst the 4th century *nummi* are dominated by GLORIA EXERCITVS (AD 330-48) and SECVRITAS REIPVBLICAE (AD 364-78) reverses. Of numismatic interest is SF126, a contemporary copy hybridising a CONSTANTINOPOLIS obverse with a GLORIA EXERCITVS reverse.

Using applied numismatic techniques, it is possible to compare the assemblage from Barnwell Lodge against the background of coin supply to Britain known as the 'British Mean' and to suggest a possible function for the site by comparing it with others (Reece 1995). In order to achieve this, the coins have been assigned to Reece periods and the total number of coins for each Reece period converted to a 'coins per thousand' (*per mill*) value. This data is summarised in Table 2.2 and displayed graphically in Figure 2.13.

As the assemblage is very small, there is a danger of over-interpreting the *per mill* values. However, Table 2.2 clearly illustrates a potential chronology for coin loss at the site with coins issues dating from the early 2nd century through to the late 4th century AD. The earliest coin is a *sestertius* of Trajan (AD 98-117). Hoard evidence from sites such as Flaggrass, Cambridgeshire, Leysdown, Kent and Alcester, Warwickshire indicates that 1st and 2nd-century *sestertii* frequently remained in circulation well into the 3rd century AD (Robertson 2000, 107, 109, 113). Therefore, this single example does not necessarily imply a Trajanic date for activity at Barnwell Lodge. Indeed, its worn appearance suggests that it was in circulation for at least thirty to fifty years before deposition.

Significant coin loss at the site commences in the late 3rd century AD and continues throughout the 4th century AD until AD 378. As the *per mill* values of Reece's British Mean demonstrate, this is a feature of coin loss profiles for the majority of Romano-British sites and therefore in this respect Barnwell Lodge is not unusual. However, rural sites such as farmsteads and villas tend to display smaller *per mill* values for Period 13 and 14 (AD 260 to 296) when compared with those for Periods 17 and 19 (AD 330-348 and AD 364 to 378) (Reece 1972). The assemblage from Barnwell Lodge possesses this feature and we can therefore be confident that the assemblage is indicative of a rural site.

Coin loss does not continue until the end of the Roman period at the site. Instead it ceases with issues of the House of Valentinian (AD 364-378). This is not a common feature of Romano-British sites in the area, the majority of which have assemblages including small numbers of Theodosian issues (for example: Wimpole, Cambridgeshire (Horton, Lucas and Wait 1994); Great Staughton, Cambridgeshire (Carson 1994); Water Newton, Cambridgeshire (Reece 1991)).

A ROMAN FARMSTEAD AT NORTH LODGE, BARNWELL

Table 2.2: Coins from Barnwell Lodge by Reece period

Reece period	Barnwell totals	Barnwell per mill	British Mean
1 (pre AD 41)	0	0	6.47
2 (AD 41-54)	0	0	11.73
3 (AD 54-68)	0	0	5.9
4 (AD 69-76)	0	0	30.85
5 (96-117)	1	32.26	19.9
6 (AD 117-138)	0	0	15.79
7 (AD 138-161)	0	0	18.67
8 (AD 161-180)	0	0	11.52
9 (AD 180-193)	0	0	4.66
10 (AD 193-222)	0	0	15.18
11 (AD 222-238)	0	0	7.29
12 (AD 238-260)	0	0	8.08
13 (AD 260-275)	8	258.06	144.3
14 (AD 275-296)	5	161.29	121.24
15 (AD 296-317)	1	32.26	17.49
16 (AD 317-330)	0	0	44.13
17 (AD 330-348)	9	290.32	245.54
18 (AD 348-364)	1	32.26	98.22
19 (AD 364-378)	6	193.55	118
20 (AD 378-388)	0	0	4.8
21 (AD 388-402)	0	0	50.25
Total	31		
Unidentified	9		

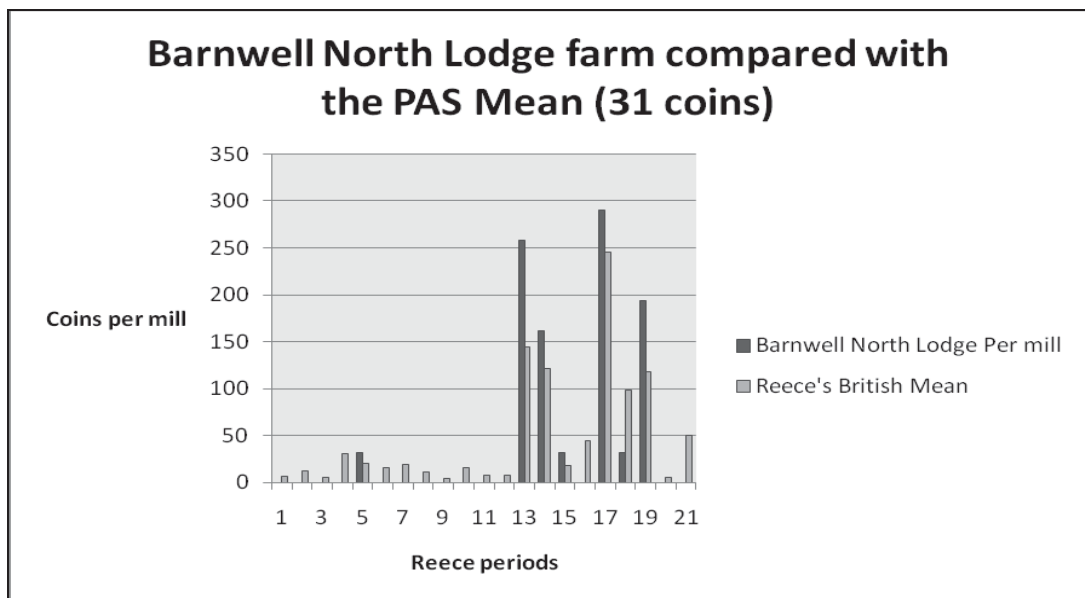

Fig 2.13: Reece histogram comparing Barnwell Lodge farm with PAS Mean

The glass

The general assemblage of glass from Barnwell is interesting and gives the impression of representing a comparatively early date range and with clear glass vessels being well represented. The tubular rimmed vessels (Fig 2.14, 3-6) are a common find on late 1st century and 2nd century sites, especially where they lack any form of decoration and a similar selection of vessels to the Barnwell repertoire is illustrated from Stonea, Cambs (Price, 196, 379). The bottle rim (Fig 2.15, 8) also points to an earlier, rather than a later dating sequence for the site, as does the window glass. None of these finds however confirms a 1st or 2nd century date, but they do show that occupation at the site may have started much earlier than has previously been thought (Hadman and Upex 1974, 278).

There were 16 fragments of window glass recovered from the site, of which three fragments are illustrated (Fig 2.15, 12-14). Most come from the area of the aisled building, especially around the bath suite. Most of the fragments, including those illustrated, show characteristics which indicate that they were produced by a casting process - one side being very pitted and roughened whilst the other side is very smooth. There has been considerable debate about the dating of window glass based on the various production processes involved in its manufacture (Harden 1961, 41-52; 1974; Boon 1966) but the general consensus at present seems to indicate that cast window glass dominated in the 1st and 2nd centuries and gradually gave way to blown window glass in the late 3rd and 4th centuries (Price 1996, 396). The group of glass from Barnwell is exclusively produced from a casting process and although this does not conclusively indicate an early date for the glass, it may point to the fact that the source of glass at Barnwell was based on early production techniques. Two of the Barnwell fragments have evidence of mortar adhering to them which must indicate that the panes of glass were set into either wooden frames or directly into stonework and mortared into position.

(Fig 2.14, 1-7)

- 1 The neck (60mm long) of a bottle in green glass, with small bubbles and black specks. This neck comes from an unguent or Mercury flask, (so called as the bases of such vessels often carry an image of Mercury on the bottom). As a group they are dated to the 2nd /3rd centuries (eg Harden and Price 1971, fig 142, 87). (BNL1987, SF155, E14)
- 2 Vessel with near complete profile 80mm high and with a diameter of 90mm in clear glass with some slight bubbling and occasional black specks. The vessel is decorated with horizontal unmarvered trails below the rim and on the shoulder of the vessel (see Price 1996, fig 126, 14-15; 1976, Illus 217). (BNL73, SF12, A12)
- 3 Tubular rim of a vessel with a diameter of 138mm in clear glass with slight bubbling and some black specks. (BNL85, SF94, C5)
- 4 Tubular rim of a vessel with a diameter of 121mm in clear glass – small bubbles and some pitting below the rim. (BNL85, SF125, E26)
- 5 Tubular rim of a vessel with a diameter of 81mm, in green/amber glass – small bubbles. (BNL86, SF125, A +)
- 6 Tubular rim of large 140mm wide bowl or dish, in blue-green glass with slight bubbling. Vessels of this form with tubular rims often date from the late 1st century – 2nd century (Isings 1957, form 44). (BNL87, SF152, E14)
- 7 Rim of vessel with a diameter of 65mm, in clear glass with slight bubbling and some external pitting. (BNL85, SF103, C5)

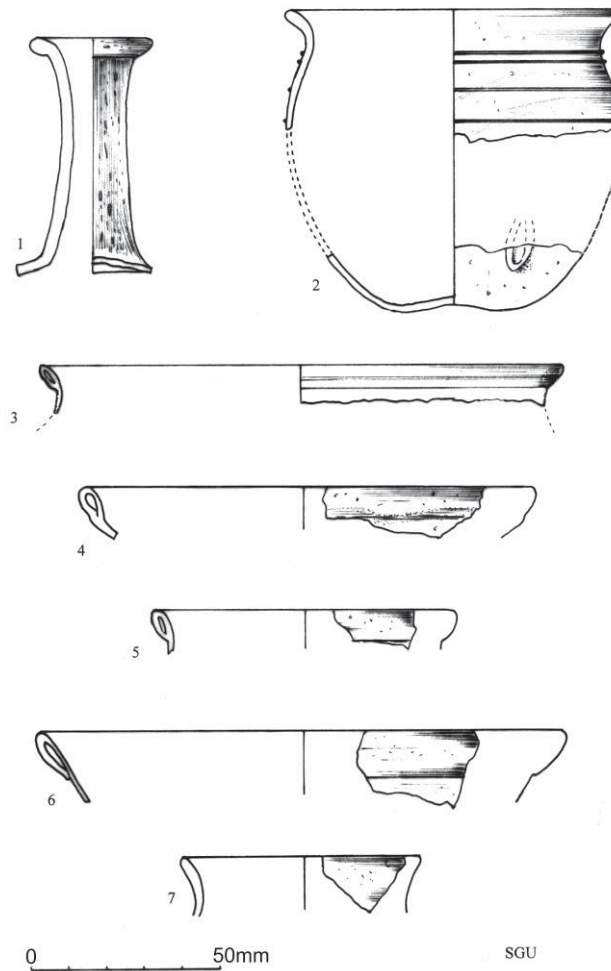

Fig 2.14: The glass (1-7)

(Fig 2.15, 8-14)

- 8 Rim of a large bottle with part of a single handle attached, in dark blue glass with some bubbling and slight external pitting. This may come from a large cylindrical or squared bottle, which are commonly dated to the late 1st-2nd century (see Harden and Price 1974, fig 143, 94-98; Price 1996, 384). (BNL73, SF25, B12)
- 9 Small sherd of glass from the lower neck of a bottle or flask in green glass with some slight bubbling. (BNL85, SF37, A14)
- 10 Small body sherd from a bottle or beaker in clear glass with over-trailed milky glass decoration (see Price 1976, 122). (BNL73, SF139, E1)
- 11 Body shed from the shoulder of a bottle or beaker in blue glass with some external pitting and black specks. (BNL87, SF124, E14)
- 12 Fragment of clear green-blue window glass with some bubbling and streaks along the edge of the fragment where it has been formed into a rounded edge. The profile of the fragment is slightly curved. The lower surface has some pitting and is rough compared to the upper surface which is very smooth. (BNL87, SF15, E14)
- 13 Fragment of clear green-blue window glass (60 x 40mm) with some slight bubbling and finishing lines running parallel to the formed edge of the fragment. The fragment has a flat, pitted, lower surface, whilst the upper surface of the glass is smooth with finishing lines running parallel to the edge of the fragment; the edge is curved and similar to that shown from a fragment at Gadebridge Park by Charlesworth (1974, fig 91, b). (BNL85, SF94, C5)

- 14 Small fragment of clear window glass with bubbling and slight finishing lined running parallel to the surviving edge of the fragment. The profile of the fragment is similar to 12 above in that it is slightly curved with a rounded edge and a rough lower and smooth upper surface. (BNL85, SF55, +)

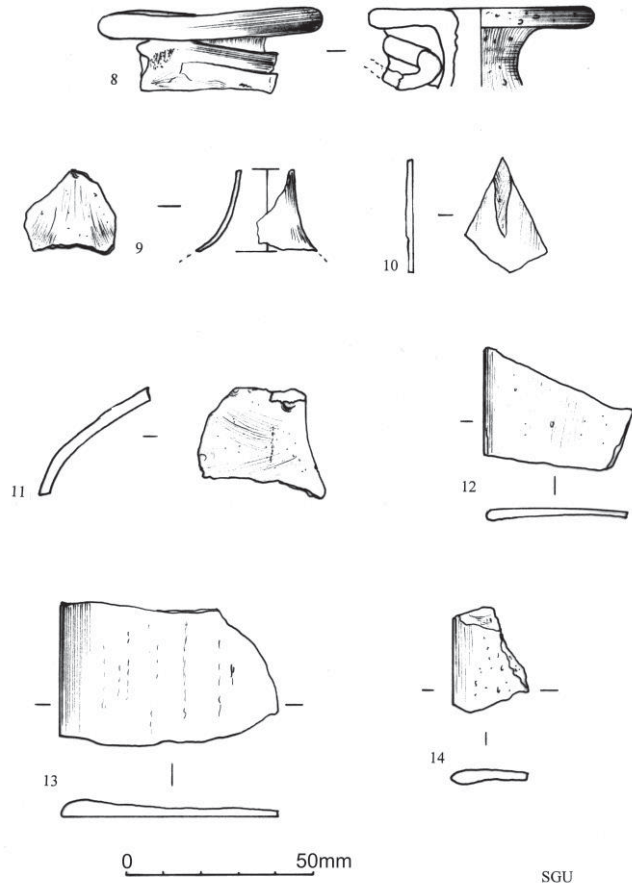

Fig 2.15: The glass (8-14)

(Fig 2.16, 15-19)

- 15 Fragment (72 x 58mm) in light green glass with slight bubbling which comes from the side of a rectangular, blown, bottle or flask. The side has a very uneven profile which ranges from 6mm to 1mm thick and one side has the remains of the base or an adjoining side wall of the vessel. (BNL87, SF139, E1)
- 16 Small, clear glass fragment of the side of a blown vessel which shows slight finishing lines and some bubbling. The angle of an adjoining side is also present. (BNL 85, SF77, C10)
- 17 Small fragment of green glass with bubbling, black specks and surface pitting which also shows some evidence of folding. It may be scrap glass or cullet (see Price, 1976, 116) that has been partly reworked. (BNL85, SF57. Ditch 1, layer 2)
- 18 Rounded, dark blue glass fragment with a central depression on one side whilst the other remains smoothed and slightly rounded. The rounded surface has considerable pitting and the overall profile is uneven. The fragment may, like 17 above, be re-claimed glass or cullet and be the remnants from the base of a former vessel. (BNL 85, SF126a, E26)
- 19 Bead in dark, green brown glass, 12mm long. The bead has three swellings and then a short straight section followed by a single swelling. This probably falls into Guido's small segmental class of which most examples are 4th century (Guido, 1978, 91-3 figs 37). (BNL85, SF81, C8)

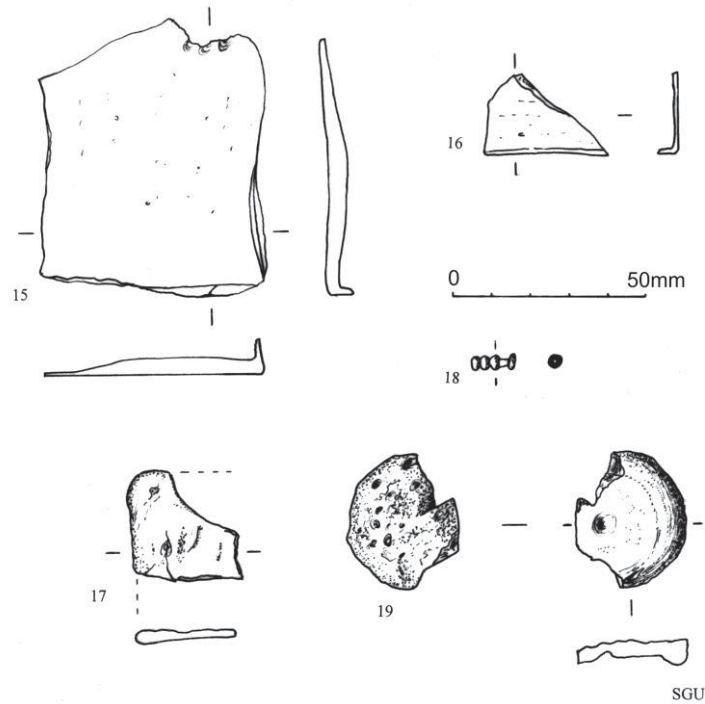

Fig 2.16: The glass (15-19)

Copper alloy objects

(Fig 2.17, 1-7)

- 1 The casing and probe (?) of a copper alloy instrument which may have formed part of a chatelaine. The casing is cylindrical, 52mm long and 12mm in diameter at its widest point, and tapers to a broken end. How the end was formed, or what shape it took is uncertain. The probe (?) is fitted inside the casing and corroded and it is thus unclear what form the probe took inside the casing and how it was fixed inside without slipping out. The other end of the probe is finished with a loop of metal which is attached to a figure-of-eight chain link, which may in turn have been attached to a chatelaine belt. Probes are known from Chatelaine sets, one from Leicester is described as a 'pointed instrument' (Kenyon 1948, 257 & fig 86, 5). Normally probes on chatelaine sets would have been hung, along with other instruments - unlike this object, which appears to be a separate instruments and sheathed within its own casing. (BNL87, SF131, E6)
- 2 Copper alloy strip, 3cm long with indications of a V-shaped notch at one end which may indicate its use as a nail cleaner. There has been much recent discussion regarding these objects, their origins within Britain and their association with toilet sets (see Eckardt, and Crummy, 2006). (BNL86, SF117, E +2)
- 3 A single scale of *lorica squamata* with a single, larger hole punched through at the top of the scale and two sets of two holes down each side (for similar shaped scales see Bishop and Coulston 2006, 97 & 139). The lower part of the scale appears to have been clipped to form a slight tapering shape. Finds of scale armour are unknown on other Nene Valley rural sites. One scale comes from the Roman military site at Longthorpe (Freere and St Joseph 1974, fig 27, 35) which is from a Claudian context. I am grateful to Dr J P Wild, for his comments on this item. (BNL85, D14)
- 4 Brooch 42mm long with one wing arm from the upper part of the brooch broken. This brooch falls into a class of the 'Colchester derivative' type and has a distribution centred within the east midlands and East Anglia. Similar brooches are known from Stonea, Cambridgeshire (Mackreth 1996, fig 93, 9-11), from Orton Hall Farm (Cambs) and from Weekley, Northants (Mackreth 1996, fig 61, 3; Jackson and Dix 1986, fig 23, 15).

- Brooches of this type generally have a date range from the late 1st to late 2nd century. (BNL73, SF13, A12)
- 5 Brooch 62mm long and with a central break along the bow and a very corroded catch plate. This brooch, like 3 above, also falls into the 'Colchester Derivative' group with a similar distribution and date range. (BNL73, SF23, B20)
- 6 A cast, copper alloy, strap end 30mm long and 19cm wide which has been slightly twisted in antiquity. The front, upper end of the object has three, chip cut, notches and the lower end has a bar or band. The sides of the strap end are crudely cut in a curvilinear form. On the reverse side there is a single, corroded rivet which may have attached the object to a leather strap or belt. There are no known, direct parallels for this object which have been found but it appears to fall into the group of strap ends similar to those found in the Lankhills cemetery at Winchester where they are all considered to be 4th century (Clarke 1979, 278-284). The only local example which is similar to the Barnwell find is from a site at Haddon (Cambs) where a strap end was recovered from a late 4th-century deposit (unpublished). There has been considerable discussion regarding late Roman belt fittings, who wore them and if the wearers were linked to the military (see Clarke 1979, 286-291; Swift 2000, 132-136). (BNL73, SF13, A12)
- 7 Copper alloy and enamelled brooch 41mm long in the form of a dog. The main enamelled insert is blue with four enamelled green spots inserted onto this ground with a fifth green spot incorporated into the design and forming the eye of the dog. It is often not easy to distinguish between dogs and hares which also appear within this repertoire of brooches, but in general term the dogs appear, as on this example, to have longer tails. This group of 'animal' brooches includes dog, deer, hares, chickens, ducks and horses with riders - the dogs being amongst the most common group (Hattatt 1982, 158-165; Johns 1996, 175). Johns has suggested that the 'dogs with spots' are Gaulish in origin (Johns 2008, 174). An identical brooch, although lacking a find spot, is in the Kettering Museum, Northants collection (Ref= KETTKM:R6) and the two brooches must come from the same workshop. This type of brooch generally dates to 50-150 AD. (BNL87, SF141. E21)
- (Fig 2.18, 8-14)
- 8 Twisted copper-alloy bracelet approximately 70mm long. The bracelet is made from two strands of wire and has a hook-like catch at the remaining terminal end; the other end would have had a similar hook or an eye to link the ends together (see Clarke 79, Type E1, 307). Such items are common on many rural sites (Neal and Butcher 1974, fig 61, 164-170; Tingle 2008, fig 19, 4; see also Upex, forthcoming for similar bracelets from Lynch Farm II – Cambs.). (BNL87, SF184. F67)
- 9 Copper-alloy bracelet approximately 40mm long and made from a single strand of wire which has a rounded and flattened terminal. The whole object is much corroded but there are indications of some decoration on the terminal in the form of a line or band. This decoration may indicate that the terminals originally had 'snake' endings similar to ones from Stonea (Cambs) (See Johns 1996, fig 107, 10-11). (BNL87, SF177, F6)
- 10 Copper-alloy bracelet fragment approximately 43mm long and made from a single strand of wire with slight indications of a 'banded' decoration. The corroded terminal end appears to have been originally of a simple loop form (see Clarke 1979, fig 37, Types D&E). (BNL87, SF158, E26)
- 11 Copper-alloy fragment, which shows evidence of originally having been silvered, approximately 61mm long with a twisted square section at either end and a rounded section part way along the object. This may come from a bracelet, although it is not a typical design. More likely it formed part of a handle for a spatula, probe or medical instrument and may have been similar to objects found at St Albans, Leicester (Frere 1972, fig 51, 166; Kenyon 1948, fig 86, 7-8) or the complete instrument from Longthorpe, Cambs, which has a similar design part way down its handle (Webster 1987, fig 23, 29). (BNL85, SF92, D25)
- 12 Copper-alloy needle approximately 54mm long and bent in antiquity. The eye is rounded and cut through the slightly flattened end of the needle which has the characteristic groove

- on both sides of this flattened area. The pointed end shows signs of being broken and cut down and re-sharpened to a bluntish point (see Jackson 1996a, fig 108, 32-37). (BNL85, SF38, +)
- 13 Copper-alloy circular rosette with six petals. The centre of the rosette has a slight depression and there is no indication of any attachment on the back of the object. This may indicate that it was fixed to a leather strap in the form of a similar rosette from Stonea (Jackson 1996, fig 110, 66). A five-petal rosette comes from Leicester (Kenyon 1948, fig 88, 19) and is described as a 'boss'. Such rosettes may have been attached to the ends of knives or to tool handles. (BNL86, SF86, +)
- 14 Copper-alloy bowl from a spoon, which would have originally been some 50mm long, 30mm wide and 7mm deep. The handle part of the spoon is missing and there is slight evidence that the bowl was originally plated with tin or even silver. Roman spoons are fairly widely described and many have traces of silvering (Frere 1972, fig 35, 74; Clarke 1979, 256). There seem to be three ways in which the handles were attached to the bowls of the spoons, an example from Stonea has a 'rat tail' junction between the bowl and the handle (Jackson 1996, fig 113, 105; see also Cunliffe 1971, fig 47, 120-1), other examples have bowls which taper into the handle (Cunliffe 1971, fig 47, 122) and the third grouping have handles which are offset to the bowls (See Clarke 1979, fig 103, 629). Due to the breakage on the Barnwell example it is difficult to say from which grouping the spoon came, but many spoons which have 'rat-tailed' junctions have near-circular bowls. Thus, this example is likely to come from one of the remaining two groups which are generally dated to the late Roman period and may be similar to an example from Ospringe, Kent (see Whiting *et al* 1931, Pl LIX). (BNL87 +)

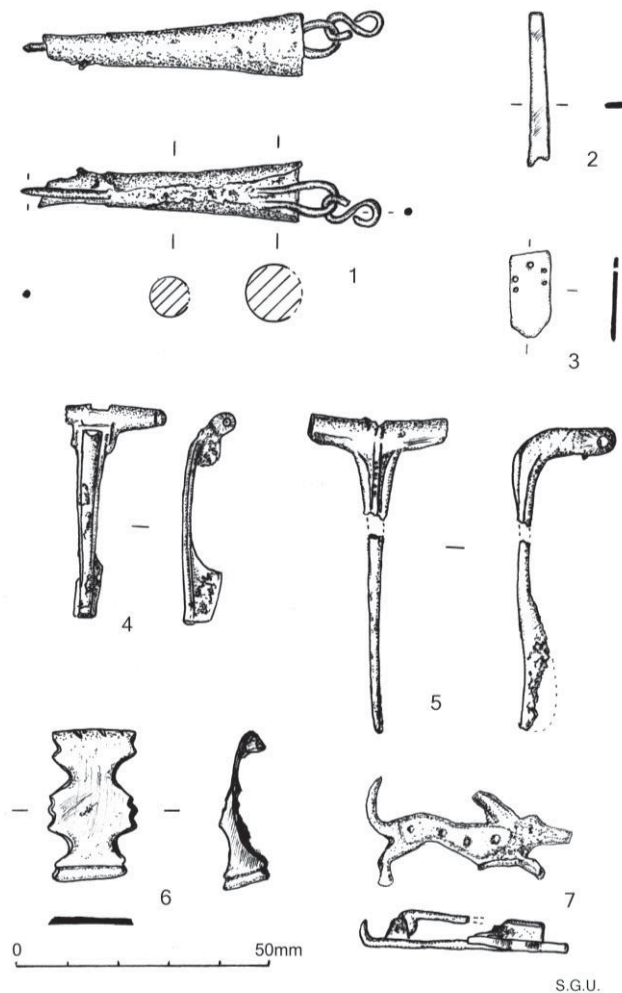

Fig 2.17: Copper alloy objects (1-7)

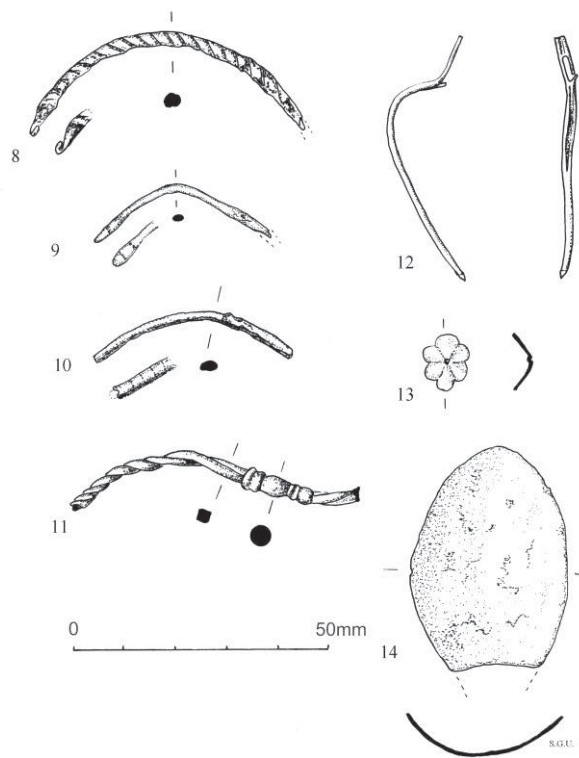

Fig 2.18: Copper alloy objects (8-14)

Iron objects

Sixty-nine iron objects were recovered. Most of the objects were heavily corroded and many unrecognisable. A selection was submitted for X-ray and this helped with some identification. Thirty-seven objects were nails or groups of nails. The nails ranged from large, square headed nails (Fig 2.19, 7) which must have been linked with the construction of the wooden building, to smaller nails which may have been used to secure planking or fencing around the yard areas. In one deposit (BNL87, E29) a group of nine hobnails (not illustrated) was recovered and probably came from the remains of a discarded shoe. Most of the remaining recognisable objects reflect the agricultural nature of the site with a selection of chisels, gouges, and knife blades. There were also a series of small iron rings which appear to be ferrules from tool fixings and three ox goads.

(Fig 2.19, 1-7)

- 1 Iron knife or cleaver blade 320mm long with a rounded tang. (BNL72, SF15, A12)
- 2 Knife blade 123mm long. The tang is rectangular and the end of the blade appears to have a slight curve at the end. (BNL87, SF179, F8)
- 3 Nail, 173mm long with a head 62mm wide and with a square shank, for fixing box flue tiles. Such nails are common on sites where rooms with hypocausts existed (eg Neal 1974, fig 74, 513-7; Meates 1987, 102, 285) and the finding of such nails at Barnwell, associated with the bath suite, is to be expected. (BNL73, SF14, A12)
- 4 Bent iron bar, 130mm long which has a 90° angle flange at one end. The object has a diamond-shaped section on the longer length of metal and a sub-rectangular profile on the remaining part. It could come from a standard L-shaped hinge staple of the sort illustrated by Neal and Butcher (1974, fig 75, 525-8). However, the profiles of the two arms of the object tend to discount this function and it may have acted as a tool affixed to an anvil for use in metal working; perhaps used for bending metal or fabricating other iron objects. (BNL85, SF67. C1)

A ROMAN FARMSTEAD AT NORTH LODGE, BARNWELL

- 5 Chisel blade 45mm wide with part of the actual blade broken on one side. The tang which is oval is heavily corroded and would presumably have been longer to take a wooden handle. (BNL86, SF123, E1)
- 6 Gouge, (?) 140mm long, with a curved blade 7mm wide. The tang seems to be very wide part way along its length and ends in a corroded point which may have taken a wooden handle. (BNL85, SF65, D4)
- 7 Part of a large nail with a head which is 34mm square. The shank of the nail is rectangular and 10mm x 13mm. (BNL87, SF175, F8)

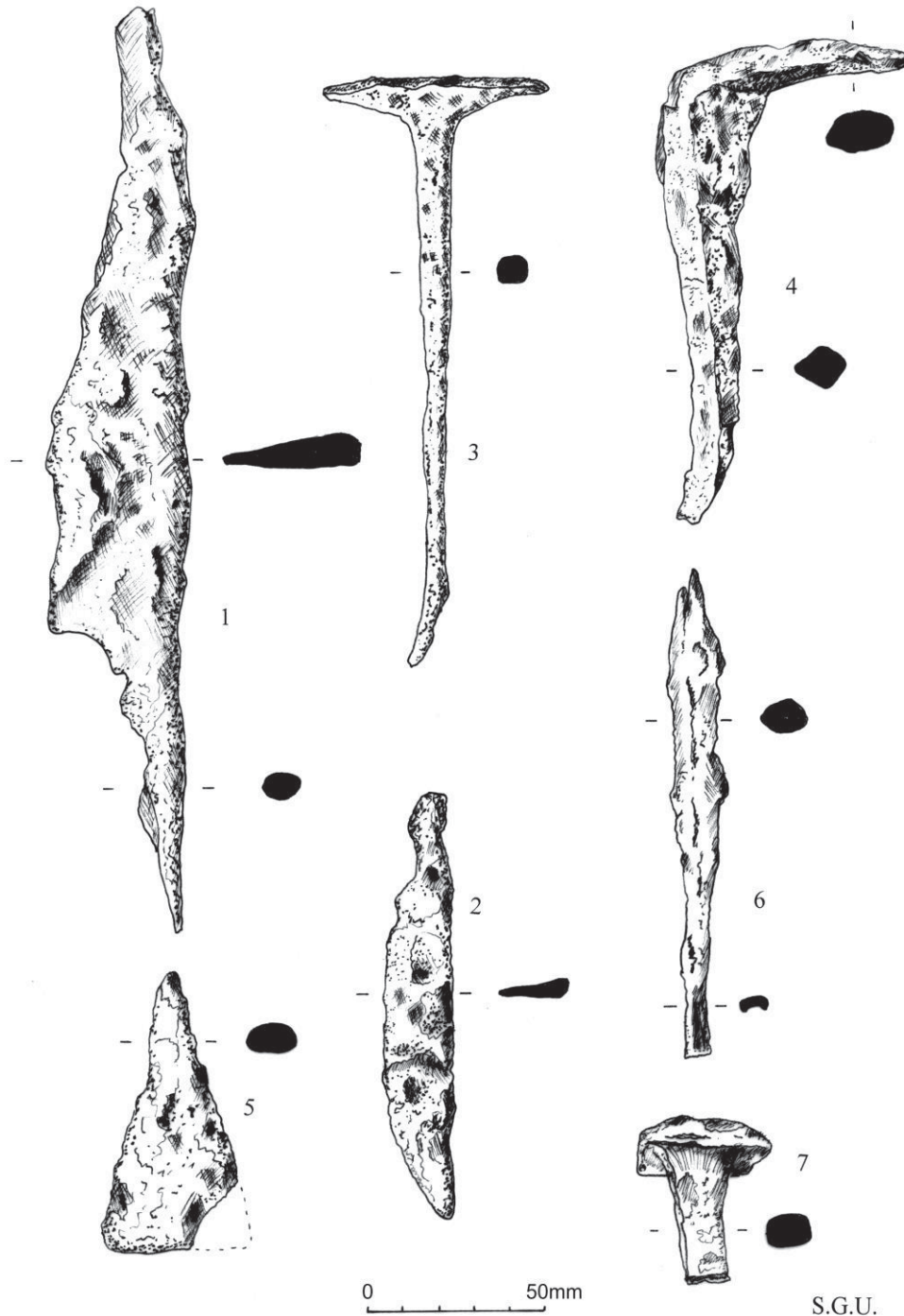

Fig 2.19: Iron objects (1-7)

Lead objects

Nine lead objects were recovered, in two groups. Group 1 (1-6) come from context BNL87, E14 and objects 7-9 come from context BNL87, F1. It must be considered that their contexts and the way in which they were found indicate that they were part of two separate hoards of lead. Objects 1-6 have already been partly described in Frend and Hadman (1994).

(Fig 2.20, 1-2)

- 1 Section of lead pipe 150mm long and 90mm wide at its broadest part with a thickness of lead forming the pipe casing of 8mm. Originally the fragment formed part of a water pipe, but appears to have been cut lengthwise and partly opened out. There are several marks on the object as if it had been cut up by the use of an axe. Weight 3.13kg (BNL87, SF143, E14)
- 2 Length of water pipe, 200mm long and 70mm wide with the lead being 8mm thick. The pipe is of standard form and similar to other pipes noted from Bath and Lullingstone (Cunliffe 1969, 126-8; Meates 1987, 93, fig 40, no 221). The pipe has been formed from a flat sheet of lead and then rolled around a 'former' to where the two edges had been joined by a tongue and molten lead then poured along the seam to seal the joint. The lower end of the pipe had been flattened in the process of it being cut up and remains of three axe marks are probably related to this cutting up process. Weight 3.47kg. (BNL87, SF142, E14)

Both of the above fragments appear to have been too large to be off-cuts from the preparation of lead piping (see for example Frere 1972, 146, 182) and most probably represent a hoard of scrap lead which had been amassed for future re-working or casting.

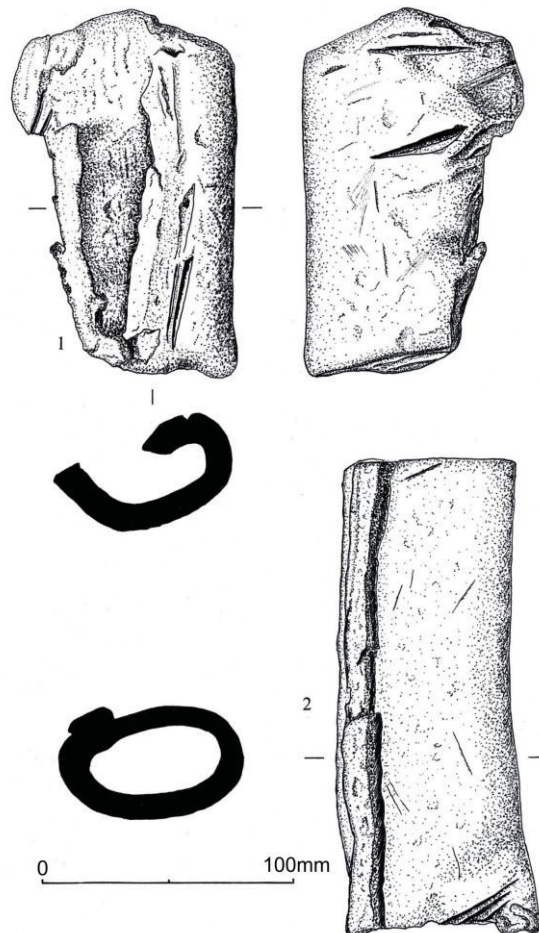

Fig 2.20: lead pipes (1-2)

(Fig 2.21, 3-5)

- 3 Round ingot (?) of lead 108mm wide and 30mm deep in the central part of the object. The upper surface is smooth with a very slight central depression, whilst the lower, rounded surface is rough. This cross-profile may indicate that the object comes from a casting of lead where the upper surface has been cooled by the air and remained smooth whilst the lower surface has been in contact with either some form of mould or just cast into a sand or earth-filled hollow. Weight 1.37kg (BNL87, SF144, E14)
- 4 A fragment of lead (100mm long, 45mm wide and 29mm deep) which represents half of what would have been a round ingot(?) similar to 3 above. This item has been cut by a saw into what would have been just under half of a casting if it were similar to 3 above. There are two deep cuts made by an axe (?) to the remaining rough, curved face of the object. Weight 0.62kg (BNL87, SF145, E1)
- 5 Rectangular fragment of lead which comes from a much larger cast sheet. The fragment has been cut unto a rectangular shape 110mm x 100mm. One corner has a bent point of lead twisted to one side, where it has been cut and twisted from what would have been the original lead sheet or object. The fragment is 9mm thick and is perhaps too thick to have come from a lead coffin; it may have come from some form of cistern or tank. Weight 1.57kg (BNL87, SF146, E14)

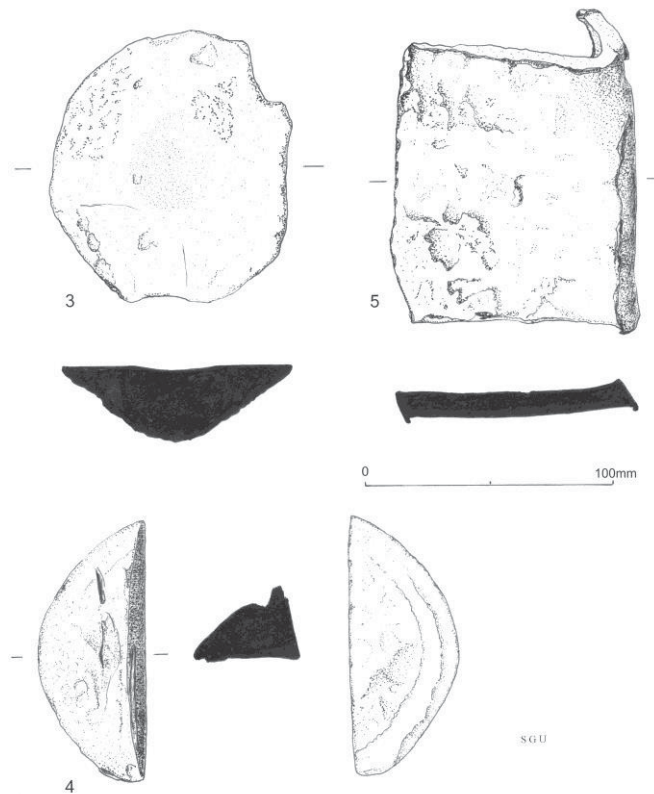

Fig 2.21 lead objects (3-5)

- 6 The fragment of lead tank from Pit III is described and illustrated within Part1: Selected other finds, Figures 26-27.

(Fig 2.22, 7-9)

- 7 Eight-sided lead plumb bob or weight, 33mm long, 20mm wide and with an irregular central hole 4mm wide. Weight 46g. (BNL87, SF166a, F1)
- 8 Biconical lead weight with the corroded remains of the iron suspension loop (Jackson 1996, 375, fig 122, 54-56). The object weighs 195g and may come from a steelyard where

it would not be necessary for it to represent an exact Roman weight (Jackson 1990, 52-53). It seems unlikely that it is meant to represent half a *libra* (corresponding to 162.5g), 34mm diameter. (BNL87, SF166b, F1)

- 9 Biconical lead weight with the corroded remains of the iron suspension loop and similar, although larger than 8 above. The object weighs 525g and most probably comes from a steelyard and like 8 above the weight does not closely match any standard Roman weight. 51mm diameter (BNL87, SF166c, F1)

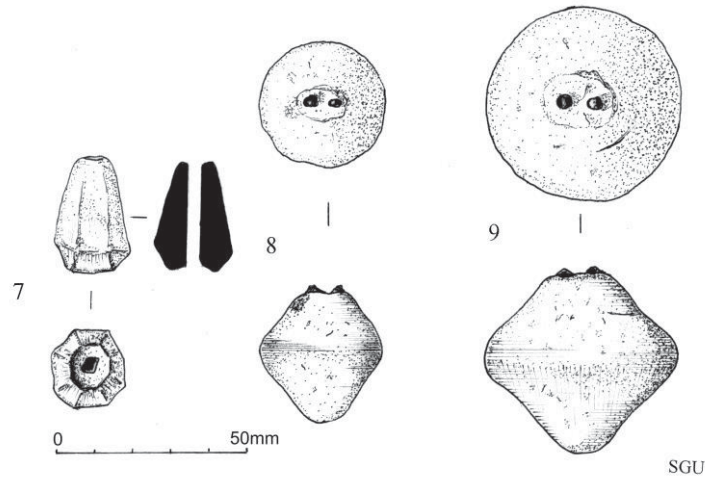

Fig 2.22: lead weights (7-9)

Shale and jet objects

(Fig 2.23, 1-4)

- 1 Fragment of shale bracelet with half-rounded profile which would have had an original diameter of approximately 70mm. This one is similar to examples from Winchester (Clarke 1979, 312) and St Albans (Frere 1972, fig 57, 222 and 224), and most of this type come from late 3rd century contexts. Similar bracelets are illustrated by Fairless (2009, figs 103, 104, 65-68) and Neal and Butcher 1974, fig 61, 173-180. (BNL85, SF93, C5)
- 2 Fragment of shale bracelet with a diameter of 4.2cm but otherwise similar to 1 above although with a slightly different internal profile. The small diameter may indicate a child's bracelet. (BNL85, SF95, C5)
- 3 A fragment of a shale bracelet with a twisted cable design and a flat lower surface. The diameter of the original object would have been approximately 84mm. (BNL87, SF159, E30)
- 4 Jet bead 20mm long and 5mm diameter at its widest point. The bead has turned ridges at either end although these do not match- one end has two ridges and the other five. A similar bead comes from South Shields (Croom 1994, fig 7). See also the bracelets illustrated by Fairless (2009, fig D11, 93 and 96) which have similar designs. Jet objects are not common on Nene Valley sites and this bead, which presumably formed part of a necklace, would have been highly prized. (BNL85, SF99 D4)

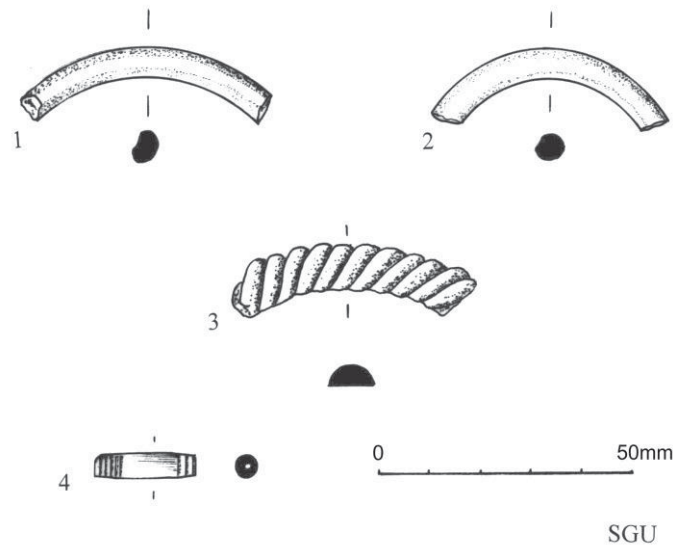

Fig 2.23: Shale and jet objects (1-4)

Bone objects

(Fig 2.24, 1- 6)

- 1 Flat bone strip 88mm long, 12mm wide and 2mm thick. The object appears to be polished on the short axis ends and may be related to weaving or textile production. (BNL87, F157, E26)
- 2 Long, thin strip of bone (105mm long) which is slightly convex and polished along its surfaces. Use unknown. (BNL87. SF187. F 67)
- 3 Bone pin 57mm long with a round section. One end is tapered to a point; the other end is broken. (BNL87. SF183. F 67)
- 4 Bone pin 58mm long with a round section. This pin differs from 3 above in that it tapers slightly at both ends, although one end remains broken whilst the other is formed into a point. (BNL87. SF154. E 30)
- 5 Flat piece of bone 40mm long by 18mm wide with cut circular decoration which is commonly found on bone objects (Neal 1974, fig 67). One side of the object is partly curved and it may come from a comb end (for example Brodribb *et al* 1972, fig 57; Galloway 1979, fig 31). (BNL86. SF105. E 30)
- 6 Circular bone bead 9mm in diameter. Bone beads are not common in Roman domestic or cemetery assemblages as they are perhaps liable to decay (Clarke 1979, 296). No parallels have been found for this bead. (BNL85. SF101. D F20)

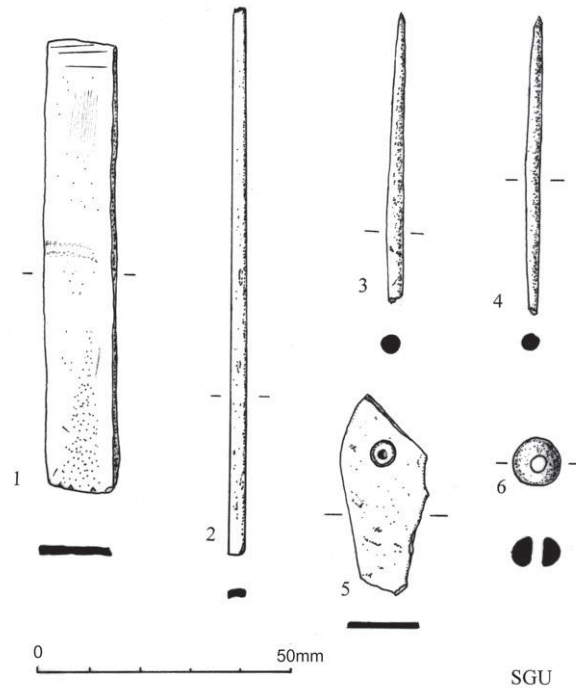

Fig 2.24: Bone objects (1- 6)

Querns

The apparent agricultural nature of the site is not supported by a large assemblage of quern fragments: this might suggest grain processing on only a minor scale. This may imply that animal husbandry formed a more important part of any farming regime and grain production was of lesser importance, although charred grain was recovered from two contexts on the site (Pit 1, layer 13; Pit 51, layer 3).

Three fragments of millstones were recovered (not illustrated):

- 1 Small (60 x 45 x 45mm) cube shaped fragment of very coarse-grained millstone grit of probable Leicestershire origin. A small worn, milling surface survives. (BNL86, C21)
- 2 Small fragment (90 x 100 x 35mm) of fine-grained millstone grit of probable Derbyshire origin. Part of the curved edge of the stone survives which would give a projected diameter of approximately 500mm. The fragment appears to be the lower stone from a rotary hand quern. (BNL86, C26)
- 3 Small fragment of a fine-grained sandstone quern, origin uncertain but may be formed from a glacial erratic. The curved edge of the fragment suggests a diameter of approximately 450mm and the fragment probably formed the upper stone from a rotary quern. (BNL86, E 1)

Wall plaster

The considerable quantities of plaster included painted wall plaster come from the destruction layers and other deposits on the site. White (lime washed) plaster predominates (BNL73, A12, A13, A14, A15) but plaster painted a deep red, and ochre (BNL73, A3; 85, D11), a pale yellow (BNL 73, A12) and a light blue (1986, D16) has also been recovered.

Only one fragment of plaster showed any sign of a design or painting scheme (1987, E26) and this had a cream background with a single brown stripe. The remaining painted fragments show no sign of any design or painting scheme; they are simple broad washes of colour, presumably indicating that the interior designs of the painted room(s) were very basic.

Small quantities of daub were also recognised in a late context from the top fills of Pit I.

Fired clay tiles

Considerable quantities of roofing tiles, both *imbrices* and *tegulae*, were found in the destruction layers over the whole site, but especially over the remains of the bath suite at the northern end of the aisled building and within the three large pits (see Fig 2). In addition, thick floor tiles (*bessales*) and box flue tiles (*tubuli*) were also found but there were no *pilae* for supporting a hypocaust floor. This point leads to the assumption that the bath suite either had some form of channelled hypocaust which has left no record within the archaeological remains or that some form of suspended floor existed but where the upper floor of the hypocaust was not supported on tiled pillars of *pilae*, but in some other way. The box flue tiles from the assemblage show that they were cross combed whilst the clay was still wet, while others tiles were left plain (see Brodribb 1987; Brodribb and Cleere 1988, 266-270; de la Bedoyere 1989, fig 34, a & b).

Stone roofing tiles

Stone roofing slates, commonly assumed to come from Collyweston, some 12 miles to the north of the site, were also found in the destruction layers and pits on the site and all relate to Period 6 (BNL 73, A5, A16 and B12). Some fragments had holes remaining where they could have been pegged to roofing timbers.

Bibliography: Coarse pottery and other finds

- Bartford, P M, 2002 Excavations at Little Oakley, Essex, 1951-78: Roman Villa and Saxon Settlement, *East Anglian Archaeol*, **98**
- Bedoyere de la, G, 1989 *The finds of Roman Britain*, Batsford
- Bishop, M C, and Coulston, J C N, 2006 *Roman Military equipment from the Punic wars to the fall of Rome*, London
- Boon, G C, 1966 Roman window glass from Wales, *Jnl Glass Studies*, **8**, 41-5
- Brodribb, G, 1987 *Roman brick and tile*, Gloucester
- Brodribb, G, and Cleere, H, 1988 The Classis Britannica Bath House at Beauport Park, East, Sussex, *Britannia*, **19**, 217-274
- Brodribb, A C C, Hands, A R, and Walker, D R, 1972 *Excavations at Shakenoak III, Site F*, Privately Printed
- Carson, R A G, 1994 Coins, in Greenfield, Poulsen and Irving (eds), The Excavation of a fourth century AD Villa and Bath-House at Great Staughton, Cambridgeshire, 1958-1959, *Proc Camb Antiq Soc*, **83**, 97-98
- Cameron, F, 1996 Other Roman Pottery in Jackson and Potter, *Excavations at Stonea, Cambridgeshire 1980-85*, 440-477
- Charlesworth, D, 1974 The Glass, in D Neal, *The Excavations of the Roman villa in Gadebridge Park, Hemel Hempstead 1963-8*
- Clarke, G, 1979 The Roman cemetery at Lankhills, *Winchester Studies*, **3**, Pre-Roman and Roman Winchester, Pt II, Oxford
- Croom, A, 1997 Personal Ornament, in Todd, *A Companion to Roman Britain*, Blackwells, 288-298
- Cunliffe, B, 1971 *Excavations at Fishbourne, Volume II: The Finds*, Society of Antiquaries, London
- Dannell, G B, 1987 Coarse pottery, in Dannell, and Wild, *Longthorpe II, The military works-depot: An episode in Landscape History*, Britannia Monograph Series, **8**, London
- Dannell, G B, Hartley, B R, Wild, J P, & Perrin, J R, 1993 Excavations on a Romano-British pottery production site at Park Farm, Stanground 1967-8, *Jnl Roman Pottery Studies*, **6**, 51-93
- Eckardt, H, and Crummy, N, 2006 Roman or Native bodies in Britain: The evidence of late Roman Nail Cleaner Strapends, *Oxford Jnl of Archaeol*, **25. 1**, 83-103

- Fairless, K J, 2009 *Objects of jet, shale and similar materials*, www.barbicanra.co.uk, site visited Oct 2009
- French, C A I, (ed) 1994 *The Archaeology along the A605 Elton–Haddon by-pass, Cambridgeshire*, Fenland Archaeological Trust/Cambridgeshire County Council
- Frend, W H C, and Hadman, J A, 1994 A deposit of Roman lead from North Lodge Farm, Barnwell, Northants, *Britannia*, **25**, 224-226
- Grant, A, 1989 Animals in Roman Britain, in Todd (ed) *Research on Roman Britain*, Britannia Monograph Series, **11**, 135-147, Society for the Promotion of Roman Studies
- Guido, M, 1978 *The Glass Beads of the Prehistoric and Roman Periods in Britain and Ireland*, Report of the Research Committee of the Society of Antiquaries, **35** London
- Hadman, J A, and Upex, S G, 1975 A Roman pottery kiln at Sulehay near Wansford, *Durobrivae: A Review of Nene Valley Archaeology*, **3**, 16-18
- Harden, D B, 1961 Domestic window glass: Roman, Saxon and medieval, in Jope (ed), *Studies in Building History: Essays in Recognition of the work of B H St J O'Neil*, 39-63, London
- Harden, D B, 1974 Window glass from the Romano-British bath-house at Garden Hill, Hartfield, Sussex, *Antiq J*, **54**, 208-1
- Harden, D B, and Price J, 1971 The Glass, in Cunliffe, *Excavations at Fishbourne, Volume II: The Finds*, Society of Antiquaries, London, 317-368
- Hartley, K F, 1996 A type series for mortaria found in the lower Nene valley, in Mackreth 1996 *Orton Hall Farm: A Roman and early Anglo-Saxon Farmstead*, East Anglian Archaeol, **76**, 199-204
- Hartley, K F, and Perrin, J R, 1999 Mortaria from excavations by E. Greenfield at Water Newton, Billing Brook and Chesterton 1956-58, in R Perrin 1999 *Roman pottery from excavations at and near to the Roman small town of Durobrivae, Water Newton, Cambridgeshire, 1956-58*, Journal of Roman Pottery Studies, **8**, 129-135
- Hattatt, R, 1982 *Ancient and Roman-British Brooches*, Dorset Publishing Company, Sherborne
- Horton, W, Lucas, G, and Wait, G, 1994 Excavation of a Roman site near Wimpole, Cambridgeshire, 1989, *Proc Cambridge Antiq Soc*, **83**
- Isings, C, 1957 *Roman Glass from Dated Finds*, Groningen
- Jackson, D, and Dix, B, 1986 Late Iron Age and Roman settlement at Weekley, Northants, *Northamptonshire Archaeol*, **21**, 41-93
- Jackson, R P J, 1996 Lead objects, in Jackson, and Potter, *Excavations at Stonea, Cambridgeshire: 1980-1985*, London, British Museum, 370-37
- Jackson, R P J, 1996a Other copper-alloy objects, in Jackson, and Potter, *Excavations at Stonea, Cambridgeshire, 1980-1985*, London, British Museum, 339-359
- Johns, C, 1996 *The Jewellery of Roman Britain: Celtic and Classical Traditions*, Routledge
- Johns, C, 2008 *Dogs: History, Myth, Art*, British Museum
- Kenyon, K M, 1948 *Excavations at the Jewery Wall Site, Leicester*, Society of Antiquaries, Oxford
- Loveluck, C, 1996 *The Anglo-Saxon settlement and cemetery remains from Flixborough: revised and summarised assessments and updated project design*, Unpublished document for Humber Archaeological Partnership
- Mackreth, D F, 1996 Brooches, in Jackson, and Potter, *Excavations at Stonea, Cambridgeshire: 1980-1985*, London, British Museum, 296-327
- Margary, I D, 1973 *Roman Roads in Britain*, (3rd edition), London, John Barker
- Meates, G W, 1987 *The Lullingstone Roman Villa*, Kent Archaeological Society monograph, **2**
- Neal, D S, 1974 *The excavation of the Roman villa in Gadebridge Park, Hemel Hempstead 1963-8*, Reports of the Research Committee of the Society of Antiquaries of London, **31**
- Neal, D S, and Butcher, S A, 1974 Miscellaneous Objects of Bronze, in Neal, *The Excavations of the Roman villa in Gadebridge Park, Hemel Hempstead 1963-8*, Soc of Antiquaries, London, 128-150
- Perrin, J R, 1999 *Roman pottery from excavations at and near to the Roman small town of Durobrivae, Water Newton, Cambridgeshire, 1956-58*, Journal of Roman Pottery Studies, **8**
- Perrin, J R, 2008 The Roman pottery, in Upex, *The excavation of a fourth century Roman pottery production unit at Stibbington, Cambridgeshire*, *Archaeol Jnl*, **165**, 265-333

A ROMAN FARMSTEAD AT NORTH LODGE, BARNWELL

- Price, J, 1976 Glass, in Strong and Brown, *Roman Crafts*, Duckworth, London, 111-125
- Price, J, 1996 Glass, in Jackson and Potter, *Excavations at Stonea, Cambridgeshire: 1980-1985*, London, British Museum 379-409
- Reece, R, 1972 A short survey of the Roman Coins found on Fourteen Sites in Britain, *Britannia*, **3**, 269-276.
- Reece, R, 1991 *Coins from 140 sites in Britain*, David Brown
- Reece, R, 1995 Site finds in Roman Britain Britain, *Britannia*, **26**, 179-206
- Robertson, A, 2000 *An Inventory of Romano-British Coin Hoards*, Royal Numismatic Society Special Publication, **20**, Royal Numismatic Society, London
- Rollo, L, and Wild, F, 2001 Iron Age and Roman Pottery, in Mackreth, *Monument 97, Orton Longueville, Cambridgeshire: A late pre-Roman Iron Age and early Roman farmstead*, East Anglian Archaeology, **97**, 46-77
- Sheppard, J, 1988 Glass, in Mackreth, Excavation of an Iron Age and Roman enclosure at Werrington, Cambridgeshire, *Britannia*, **19**, 101
- Swift, E, 2000 *The end of the western Roman empire*, Tempus
- Tingle, M, 2008 Archaeological Recording of a Roman Villa at Brigstock Road, Stanion, Northamptonshire, April-May 2002, *Northamptonshire Archaeol*, **35**, 95-136
- Tomber, R, and Dore, J, 1989 *The National Roman Fabric Reference Collection. A Handbook*, Museum of London Arch Services, Monograph, **2**
- Tyers, P, 1996 *Roman pottery in Britain*, Batsford, London
- Webster, G A, 1987 Other objects of bronze, in Dannell and Wild, *Longthorpe II. The Military works-depot: an episode in landscape history*, Britannia Mono Series, **8**, 87-95
- Welsh, K, 1994 *Iron Age and Roman Settlement Remains at Tort Hill, Sawtry, Cambridgeshire* County Council Archaeological Field Unit report, **103**
- Whiting, W, Hawley, W, and May, T, 1931 *Report on the excavations of the Roman cemetery at Ospringe, Kent*, Society of Antiquaries, Research Reportt, **8**, London
- Woods, P J, 1970 Excavations at Brixworth, Northants 1965-1970: The Romano-British villa, *Journal of the Northampton Museum and Art Gallery*, **8**
- Woods, P J, and Hastings, B C, 1984 *Rushden: the early fine wares*, Northamptonshire County Council
- Young, C J, 1977 *The Roman pottery industry of the Oxfordshire region*, BAR British Series, **43**, Oxford

The animal bone

by Bethan R Upex

Methods

For the purpose of this report the material has been recorded using the methods outlined by Loveluck (1996) and Dobney & Rielly (1988). Caprine dental wear stages were recorded after Payne (1972 & 1987) and cattle and pig mandibles were assigned general age categories following O'Connor (1988). Epiphyseal fusion was recorded for all identified fragments to provide additional data on the age at death. Butchery marks, preservation, pathologies, burning and dog/rodent gnawing were also recorded. Key diagnostic elements were measured to the nearest millimeter using dial calipers, all measurements followed Von den Driech (1976). Throughout the report Barnwell is compared to two late Roman sites from the surrounding area: Orton Hall Farm (King, 1996) and Haddon Lodge Farm (Baxter 2002); as well as a variety of other published faunal assemblages from East Anglia.

An overview of the assemblage

A total of 1387 fragments were examined, all of the fragments were collected by hand, biasing the assemblage towards large mammals. Animal bone was collected from all areas of the site, and from all periods. However, due to the small nature of the assemblage and the dominance of the deposits containing bones periods 4 and 5 all material was assumed to be from the 3rd and 4th centuries. At Barnwell 78% of all contexts were recorded as having good preservation, just 5% of contexts showed evidence of burning, 84% of contexts showed no evidence of animal gnawing, with the remainder showing evidence of dog gnawing. Bone fragments between 50-200mm in size came from 37% of all contexts, with 28% of contexts containing fragments larger than 200mm.

The relative importance of species

There is a clear predominance of cattle and caprine remains at Barnwell, followed by pigs; other main domesticates include horses and chicken, both of which are present at the site, although in much smaller numbers. The raw data by species and by element is shown in Tables 2.3 and 2.4. The total number of fragments by species for the main domesticates are shown in Table 2.3 as a percentage of the minimum number of individuals (MNI) and in Table 2.4 as a percentage of the number of individual skeletal parts (NISP). The NISP data clearly demonstrates the importance of cattle for the site and this fits with a large majority of sites in the region for the Romano-British period. The unidentified fragments are shown in Table 2.5.

Table 2.3: The total number of identifiable fragments per species and the minimum number of individual (MNI) animals

Species	Total fragments (NISP)	MNI
Cattle	195	9
Sheep	101	11
Pig	22	5
Horse	24	2
Cat	1	1
Dog	1	1
Deer	1	1
Chicken	4	1
Goose	9	1
Woodcock	1	1
Corvidae	1	1
Fish	1	1

Table 2.4: The number of identifiable elements for the main domesticates

Element	cattle	sheep	pig
humerus	3	4	1
radius	3	5	-
metapodial	2	3	-
metacarpal	7	9	5
metatarsal	16	1	2
pelvis	17	1	-
femur	1	3	-
tibia	8	4	-
calcaneous	2	2	-
astragulas	9	-	-
phalanges	33	4	2
teeth	55	45	2
mandibles	15	19	8
scapula	17	1	2
horncore	7	-	-
total	195	101	22

Table 2.5: The number of unidentified fragments

	Unident'd	LM	MM1	MM2	SM	Bird
Total	425	437	448	36	5	36
vertebra		29	7	0	0	5
ulna		2	0	0	0	1
tibia		1	0	0	0	0
teeth		17	23	1	0	0
tarsles/ carples		1	0	0	0	0
talus		1	0	0	0	0
sturnum		2	0	0	0	2
scapula		31	7	0	0	0
sacrum		1	0	0	0	0
ribs		104	76	18	0	6
radius		1	0	0	0	0
pelvis		7	1	2	0	0
mandible		1	0	0	0	0
matapodial		5	0	0	0	0
metatarsle		1	0	0	0	0
maxilla		2	2	0	0	0
mandible		47	22	0	0	0
long bone		161	308	12	0	7
radius		4	1	0	0	0
horn core		7	0	0	0	0
femur		3	0	0	0	0

Fragments which could not be identified to either species or element

LM = large mammal (horse, cow or large cervid); MM1 = medium mammal (sheep, pig or small cervid); MM2 = medium mammal (cat, dog, or hare); SM = small mammal (mice, rats, voles, shrews etc).

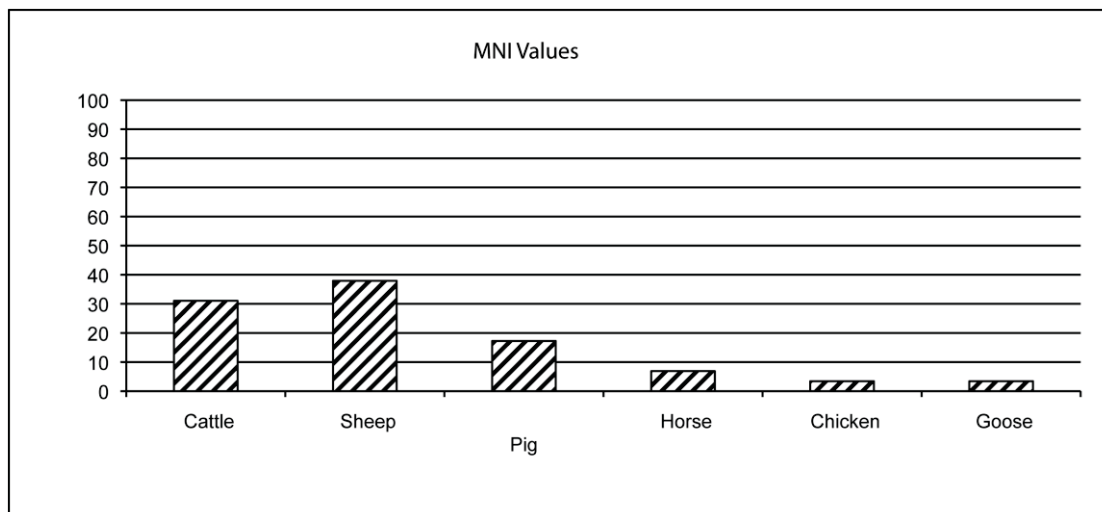

Fig 2.25: MNI values for main animal species

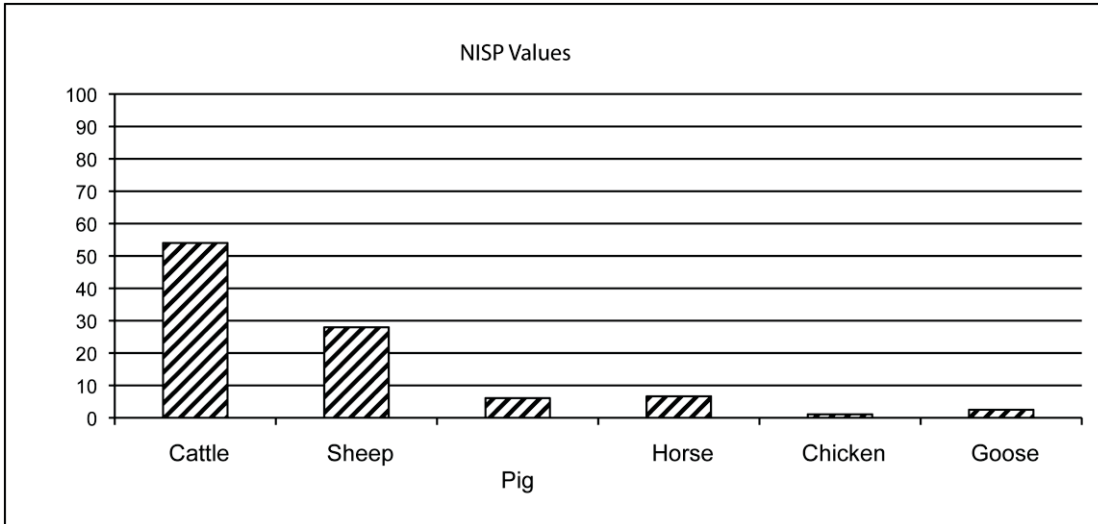

Fig 2.26: NISP values for main animal species

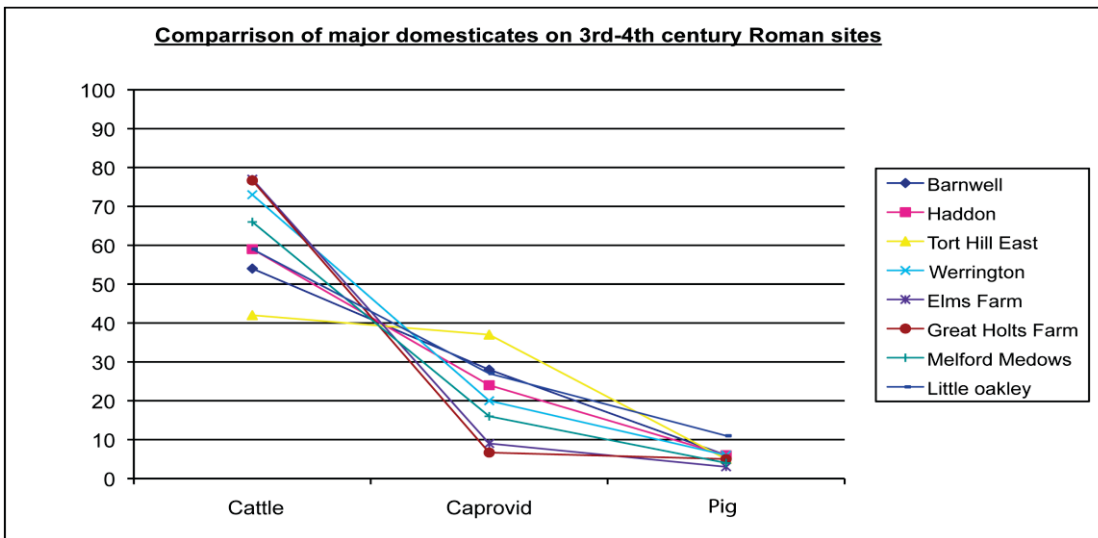

Fig 2.27: Comparison of sites from the region using NISP data

(Hinman 2003, Welsh 1994, Mackreth *et al* 1988, Johnston & Albaralla 2002, Albaralla 2003)

The importance of cattle in the Romano-British economy and diet is well known and most probably reflects the larger and more intensive farming practices required by the expanding population (Grant 1989, 138). The traditional Roman diet as practiced in Italy would have been based on pork consumption rather than beef consumption, but it has been suggested by King (1978) that the extensively beef based diet was imported into Britain by the central European legions of the Roman army. King (1984) also suggests that the degree of Romanization of a site can be deduced from the relative frequencies of the main three domesticates. Urban sites (more likely to be Romanized) would have higher concentrations of cattle (and to a lesser extent pigs) than rural civilian settlements. This pattern is common on many Roman sites, Dobney *et al* (1996, 44) suggest that this is because pigs are ideal animals for keeping in small numbers in back yard pens, where they could be used effectively to recycle household waste into meat and fertiliser. Barnwell with its high frequency of cattle and sheep, but low frequency of pigs, falls at the scale as a rural settlement. But this may also be a factor of the long tradition of breeding cattle in the east of England and the small sample size (Johnstone & Albarella 2002, 14).

Eleven percent of the combined horse and cattle remains were from horses. A survey of 190 Roman sites in central England revealed that on average horses represent 5% of the total horse and

cattle bones; the ratio between the two taxa is higher on rural sites (1:10) than urban sites (1:25) (Johnstone & Albarella 2002, 33). Although this may be a product of waste disposal patterns as much as socio-economic ones; horses may well have been kept on urban sites but been disposed of elsewhere. Barnwell fits into the rural end of this scale with a ratio of 1:8. Orton Hall Farm, Haddon Lodge Farm also show high percentages of horse remains in the late Romano-British periods. It has been suggested that the increase in the number of horses present on some sites in the later periods may indicate an increase in ranching practice at this time (King 1978).

Body part distribution

In all three main domesticates there are no clear element distribution patterns. In cattle the highest numbers of fragments are from teeth and phalanges, which would suggest a primary butchery site. However, there are also equal numbers of elements from both feet bones (such as the metacarpals, metatarsals, and astragalus) and meat bearing bones such as the scapula and pelvis. There are also large numbers of ribs and vertebrae. A very similar distribution is seen for caprines except for slightly a higher representation of teeth and meat bearing bones such as the humerus and femur. Unlike sheep and cattle, pigs only made up only a very small percentage of the total number of fragments recovered from the site and 37% of these were mandibles. In all three species the lack of any clear distribution patterns in both meat bearing bones, such as the scapula, and waste bones such as the metapodials suggests that the animals were killed and butchered and eaten at the site, with no obvious deposition of specific parts that could indicate industrial or craft refuse. This would fit with the idea that the site was a reasonably self-sufficient rural settlement.

Butchery

Butchery marks were quite common on cattle bones with 15% of all recordable bones displaying one or more cut marks. Butchery marks were most common on the metatarsals, with 37% of all metatarsals showing evidence of butchery; these were consistently located on the rear side of the proximal end. Scapula also showed a high degree of butchery with 35% of all scapula displaying chop marks, mainly on the glenoid region, cuts were also commonly found on the pelvis and ribs. Unfortunately there were very few complete scapula recovered from the site, while none of those recovered showed any evidence of hook damage, the limited number cannot rule out the possibility of meat being hung either in a smoker or brining vat for preservation. Dobney *et al* (1996, 26) suggest that scapula with no evidence of trimming around the glenoid cavity may have been utilised fresh, straight off the bone or hot smoked. This seems most likely for the Barnwell samples as in only very few cases do the scapula display signs of the glenoid cavity being trimmed. The butchery marks are more likely to represent primary dismemberment of the carcass such as the removal of the legs and the dividing of the remains into large joints (Johnson & Albarella 2002, 16).

While the majority of butchery marks on cattle bones fall into the above mentioned groups, other butchery marks such as knife marks were also present, indicating that meat, once reduced into joints, was then filleted for consumption. The patterns found at Barnwell fit with similar patterns found at Lincoln and Elms Farm, Essex, as well as Haddon Lodge Farm (Baxter 2002) and Orton Hall Farm (King 1996). The butchery evidence, like the body part distribution, suggests that the animals were butchered and eaten on the site.

There was only one example of butchery marks on the caprine remains from Barnwell. This was a mandible that had a large number of knife marks on the lateral side. Only two bones from the pig assemblage had evidence of butchery, both were scapula, displaying chop marks located on the neck, just before the glenoid cavity. One scapular had the glenoid chopped off entirely. This lack of butchery marks is not unusual as small/medium mammal-sized carcasses were usually dismembered using a knife to cut through tendons and joints and this method leaves less obvious marks than a cleaver which was used on larger animals (Johnstone & Albarella 2002, 26).

There were no examples of butchery on the horse bones. This may be due to the limited sample size, but also may be due to the fact that it is well recorded that in the most 'Romanised' parts of

the empire horse meat was only eaten in emergencies (Tacitus Annals II, 24 & Histories IV, 60; Quoted in Luff (1982, 248) There was also no butchery found on the horse bones from Haddon and Orton Hall Farm.

Ageing

The epiphyseal fusion data for Barnwell shows that a high proportion of cattle had reached skeletal maturity before their death, with over 60% of all the bones in the late-fusing category fused. This suggests that over half of the cattle at the site were mature individuals of at least five years old or more. The tooth wear patterns also support this, with 50% of cattle surviving into adulthood (Fig 2.28). This pattern is consistent with other Roman sites from the region with Great Holts Farm, Essex (Albarella 2003); Hacheston, Suffolk (King 2004); and Little Oakely, Essex (Bartford 2002) all display similar profiles. Barnwell fits neatly into this regional picture with the majority of its cattle being slaughtered at a relatively old age. At Haddon Lodge Farm and Orton Hall Farm animals were generally slaughtered over 4 years of age, both of these sites show a change from the early periods of Roman occupation (1st and 2nd centuries) when large numbers of cattle were killed off at a very young age. This change across the region from the consumption of very young individuals in the 1st and 2nd centuries to much more mature cattle in the 3rd and 4th centuries suggests an increased emphasis on arable farming, and as a consequence the increased use of cattle for traction (Baxter 2002, 122).

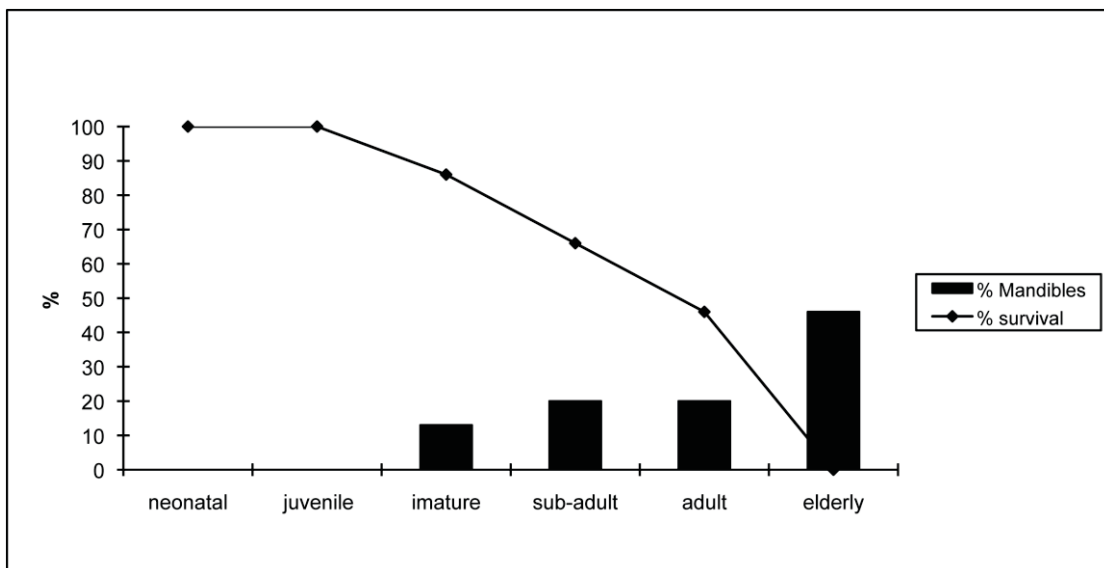

Fig 2.28: Tooth wear pattern on cattle

The caprine dental wear patterns demonstrate that by the age of two to three years over 50% of the animals at Barnwell had been killed (Fig 2.29). The mortality profile from Barnwell compares well with the ideal herd exploitation profiles produce by Payne (1972) suggesting that the herd was kept mainly for meat. However, the fact that animals were surviving beyond three years and past the point when their maximum body weight was achieved, suggests that secondary products were also important, such as milk and wool. The sheep exploitation curves from Lincoln, Haddon and Elms Farm also appear similar to the one from Barnwell. However, a slightly greater number of older sheep appear to be surviving at Barnwell than at these other sites.

Given the limited number of pig bones recovered very little can be said with confidence. The majority of bones are fused; this combined with the teeth wear suggests that the majority of the animals were adults when they died but with no examples suggesting that any animals survived into old age. This pattern is similar at several other sites in the Nene Valley, such as Orton Hall Farm where only limited numbers of pig bones were recovered, of which the majority were from

mature animals, suggesting that they were kept only in small numbers and killed to provide meat. Baxter (2002, 125) also reaches the same conclusions about the pig remains from Haddon.

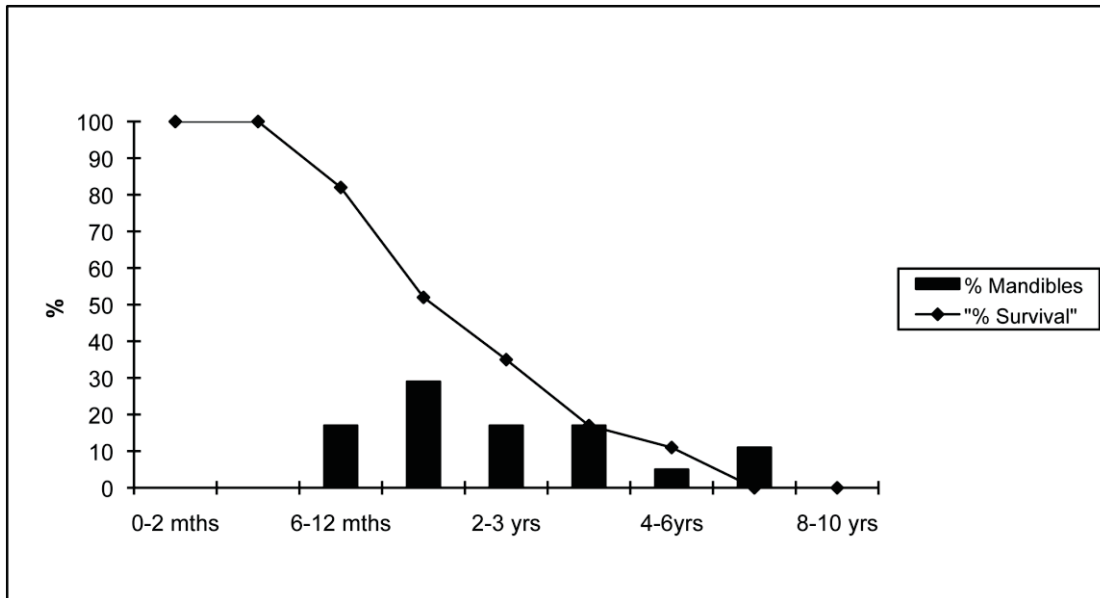

Fig 2.29: Caprine dental ware patterns

All of the bones and teeth recovered from horses represent adult individuals. All of the permanent teeth recovered exhibited wear, and all of the epiphyses on the bones were fused, indicating that the animals were over three years of age. The two permanent incisors recovered were all worn, and following the wear stages outlined by Levine *et al* (1982) were aged at approximately five years, and three to four years of age. The absence of any young individuals suggests that horse breeding was not being carried out at the site and that the animals were mainly working adult animals. This is similar to the conclusions drawn at the two main comparative sites in the Nene Valley at Haddon Lodge Farm and Orton Hall Farm.

Pathology

Thirteen percent of the total cattle fragments recorded from Barnwell showed signs of pathologies. All of the pathologies recorded were located on the lower extremities of the limbs, mainly the distal metatarsals and phalanxes. Of the total number of metatarsals recorded, twenty-five percent of them had severe exostosis development at the distal ends, ranging from stage 3 to 4 in the recording protocol laid out by Bartosiewicz *et al* (1997). The affected metatarsals also displayed broadening and splaying of the distal ends ranging from stage 2 to 4, as well as slight lipping at the proximal articular surfaces (Fig 2.30). There were also several examples of eburnation (polishing) and grooving on the distal condyles, suggestive of severe joint degeneration. Thirty three percent of phalanges also displayed similar symptoms of exostosis, splaying and eburnation and grooving of the joint surfaces (Fig 2.31). These are classic symptoms of osteoarthritis and as discussed by Bartosiewicz *et al* (1997) may be indicative of draught cattle. Similar arthropathies have also been noted at Great Holts Farm (Albarella 2003, 195) where they were associated with working stress, generated by ploughing or pulling carts. However, given the age of the animals at the site, their large body size and the heavy clay soils of the region, interpreting these pathologies as evidence of traction is difficult.



Fig 2.30: Pathological cattle metatarsals (Scale 10mm intervals)



Fig 2.31: Pathological cattle phalanges (Scale 10mm intervals)

There were just two examples of pathologies in the sheep bones. The first was a metapodial showing severe bone reformation and growth along the posterior side, reaching almost to both particular ends, suggestive of a severe bone infection. The second was a jaw showing a small dental abscess on the lateral side. There was one pathological horse bone from the site, a metatarsal that showed a smooth compact swelling mid-shaft on the anterior surface of the bone. This may have been caused by repeated trauma to the area, potentially indicative of hobbling.

Biometry

Only cattle four horn cores were recovered, and two had their tips missing, removing the possibility of creating full measurements profiles for them. The greatest lengths for the two complete horn

cores are 133mm and 166mm. These figures fall across two of the size categories as outlined by Armitage and Clutton-Brock (1976): short-horned cattle (96-150mm greatest length) and medium-horned cattle (150-220mm greatest length). Size variations between cattle can be caused by a number of different factors, including species and sexual dimorphism. Astragalus and metapodial measurements are plotted in Figures 2.32 & 2.33, and they suggest some size variation within the population indicating the presence of males and females, or males, females and castrates at the site.

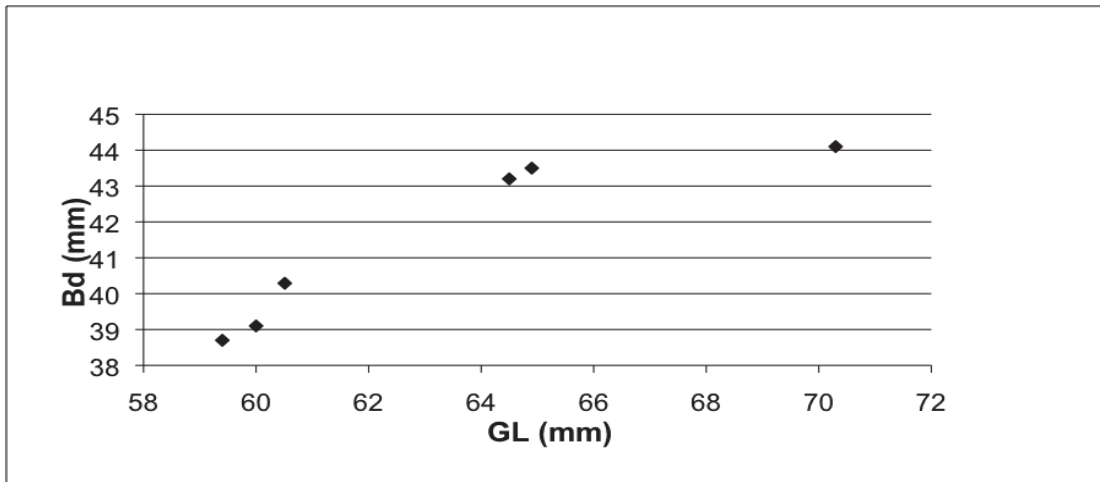

Fig 2.32: Variation in astragalus length and breadth measurements from Barnwell

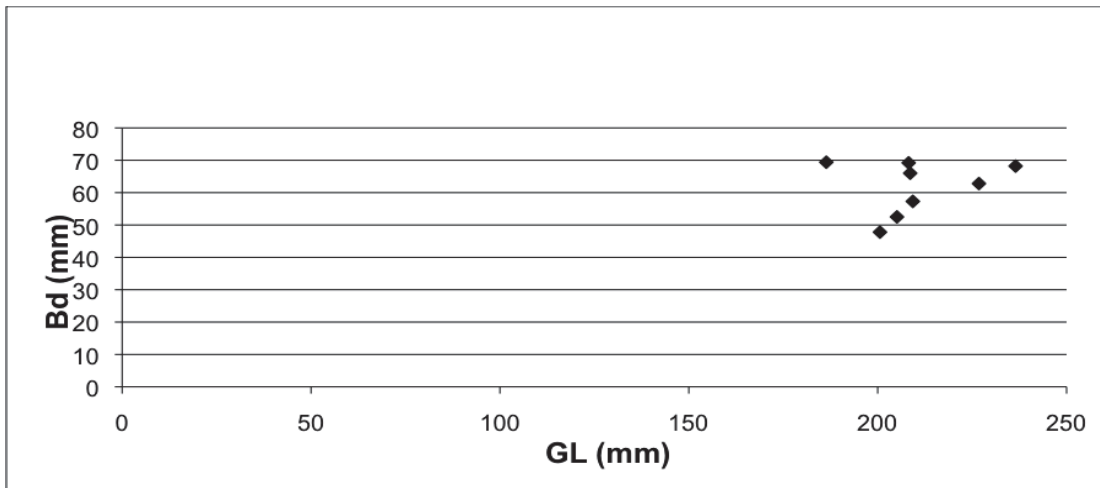

Fig 2.33: Variation in metapodial length and breadth measurements from Barnwell

A comparison between the mean astragalus size at Barnwell and the mean size at several other 3rd and 4th-century sites, suggests that the animals from Barnwell were considerably larger than at the other sites (Fig 2.34). Its closest rival in size is the mean measurement from Cross Keys, Owslebury, Hants (Maltby 1987a) but even this measurement falls several millimeters short of the one from Barnwell. With this in mind, the metapodial measurements were studied and the mean measurements of length and breadth produced for Barnwell are compared with other sites for the same period (Fig 2.35). Barnwell's mean measurements are larger than the others, with the closest in size coming from Haddon Lodge Farm, located only a few kilometers north of Barnwell. It must be remembered that 25% of the metatarsals recorded displayed quite severe pathologies at the distal ends, including splaying, which will have affected the mean measurement produced, but even with this in mind the metapodials are still considerable larger than those from sites such as Lincoln and Elms Farm.

In order to attempt to reduce the errors in the data set caused by the pathological splaying of a high percentage of the metatarsal bones, log ratio plots were produced, allowing measurements from

different elements to be combined (Fig 2.36). As suggested by Davis (1996, 593-612) width and depth measurements were kept separate, as there is better correlation between measurements taken on the same axis than between those on different axes. As there is no published British standard for cattle, the standard used was the Elms Farm mean measurements from period 2 (Johnson & Albarella 2002, 70). Log ratios using the same standard were then created for the sites of Lincoln (Dobney *et al* 1996), Elms Farm (Johnston & Albarella 2002), Victoria Road (Maltby 1987b) and Bancroft (Levitan 1990). These results also suggest that the cattle at Barnwell were larger than those of all of the other sites used in the comparison, with Bancroft being the closest in size (Levitan 1990). Unfortunately, there was not enough raw data published to allow the creation of a log ratio plot for the very large cattle known from Great Holts Farm, Essex (Albarella 2003).

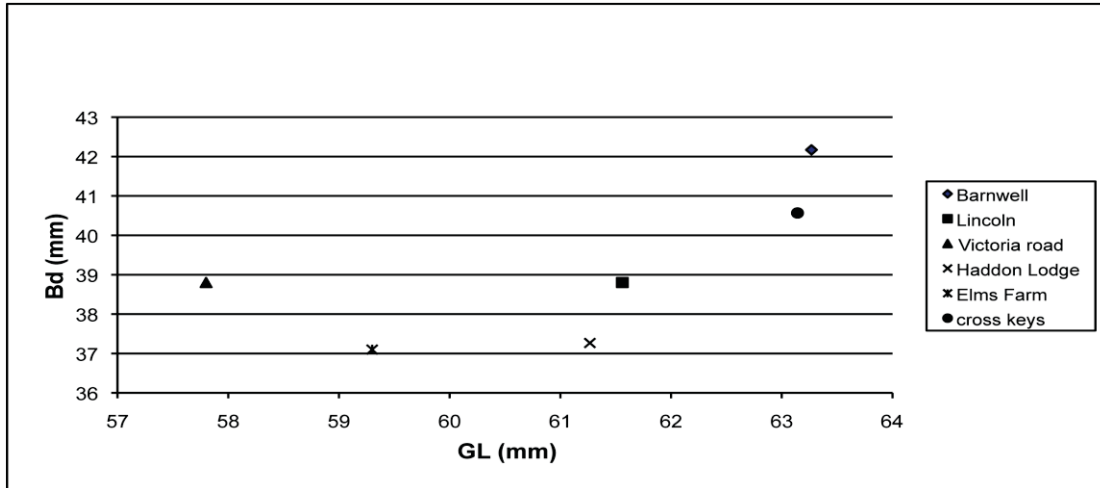

Fig 2.34: Comparison of mean astragalus measurements between Barnwell and other sites in the region (Dobney *et al* 1996, Maltby 1987b, Hinman 2003, Johnstone & Albaralla 2002 & Maltby 1987a)

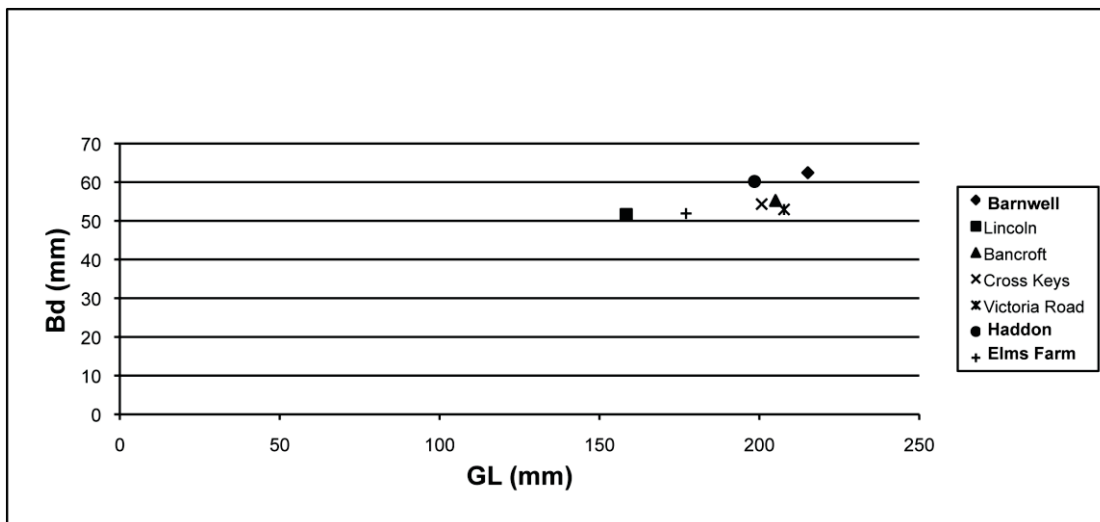

Fig 2.35: Comparison of mean metapodial measurements between Barnwell and other sites in the region (Dobney *et al* 1996, Levitan 1990, Matlby 1987b, Hinman 2003 & Johnstone & Albarella 2002)

The size of the cattle from Barnwell can be interpreted in a variety of ways. Sexual dimorphism can, as already discussed, cause large differences in the size of cattle and this combined with the fact that the animals appear to have been used for traction could possibly explain the large size. However, it would be very uncommon to have a population consisting of so many bulls on one site and the metapodial and astragalus measurements, as previously outlined, suggest that a degree of

sexual dimorphism is present on the site, ruling out an entirely male population. One possibility, suggested by Albarella (2003) in relation to the site at Great Holts Farm, Essex, is that the large cattle found at Great Holts Farm represent the first generation of imports from the continent. The possibility that cattle are imported into Britain from the continent has been debated for some time by archaeologists. Maltby's work suggests that there is evidence for larger cattle in some areas of Britain, even in the early Roman period, and strongly argues for importation of larger breeds from the continent, whereas Armitage refutes this, suggesting that the improvement in cattle size is due to improved breeding (Grant 1989, 143).

An increase in the size of cattle in the 3rd and 4th centuries has been noted at several sites in Britain, including Lincoln, where in the 3rd century the size of cattle increased and then decreased slightly in the 4th century (Dobney *et al* 1996). This may have been due to the importation of larger cattle into the site in the 3rd century and then subsequent interbreeding in the 4th century. Johnson & Albarella (2002) conclude in their work at Elms Farm that if the cattle from Great Holts Farm represent first generation imports into Britain of larger-sized animals, then the slightly smaller ones from Elms Farm may represent interbreeding between the imported species and the smaller native cattle of Britain. The available data suggests that the cattle at Great Holts Farm were slightly larger than the ones from Barnwell, standing at an average withers height of 1.30m (Albarella 2003), whereas the cattle from Barnwell stood at a mean height of 1.20m with a range of 1.09-1.38m. This is still larger than the cattle from Lincoln, which ranged from 1.05-1.25m tall.

While caution is necessary given the small sample size from Barnwell, the evidence suggests that these cattle were on average larger than the ones from all the comparative sites used, with the exception of Great Holts Farm. This would suggest that the cattle from Barnwell, could have been relatively recent imports from the continent, with some interbreeding with small native British species, accounting for the slightly smaller average size. This could indicate that the site at Barnwell held slightly more status than the rather un-pretentious layout suggests. The presence of potentially imported cattle, indicates connections with the continent and the southern provinces of Rome, linking with the other products imported and consumed at the site, such as the contents of the amphora (see below).

Measurable caprine elements were not nearly as common as the cattle elements making meaningful metric analysis difficult. Using the calculations of Teichart (1975) the average withers height for the sheep from Barnwell was calculated at 0.59m. This falls within the same range as the sheep from Lincoln that had a withers height in the 4th century of approximately 0.60m, and the sheep from York, which averaged 0.59m (Dobney *et al* 1996, 32).

Metric analysis for pig and horse was difficult given the extremely limited numbers of postcranial fragments recovered from Barnwell. For horse it was possible to estimate the withers heights using the methods outlined by Von Den Dreich & Boessneck (1974). The average withers height calculated for horses from Barnwell was 1.47m (approximately 14.3 hands). This is slightly larger than the mean withers height for horses from Haddon (1.32m, approximately 13 hands). It is also larger than the animals from Orton Hall Farm, which ranged from eleven to thirteen hands. The Barnwell animals are of sufficient stature to have been used as military mounts as these generally ranged from thirteen to fifteen hands. Collins (1994, 151) tentatively suggests that the animals from Haddon may have been purchased from the Roman army as ex-military mounts. As the animals from Barnwell are of a similar stature, and the two sites are so close, this may also be a plausible explanation for the large animals found at Barnwell.

A ROMAN FARMSTEAD AT NORTH LODGE, BARNWELL

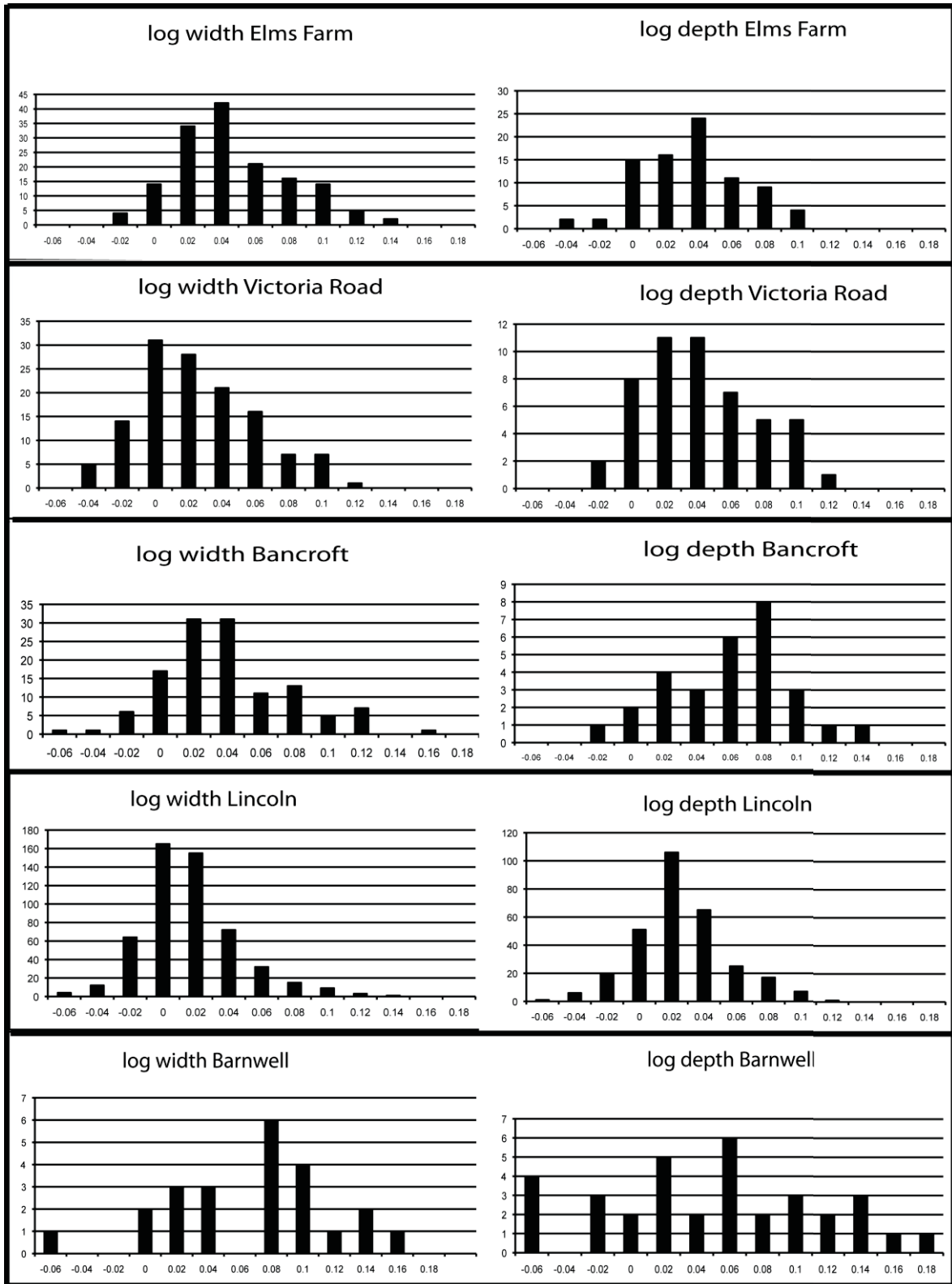

Fig 2.36: Cattle log ratios comparing cattle from Barnwell with other sites in region (The X axis shows logarithmically scaled width and depth measurements, the Y axis the number of specimens)

Other mammals

Dogs and cats

One large dog metapodial was recovered from the site at Barnwell. This was of similar size to a modern German Pointer. Dog bones in the Roman period are relatively common and of a wide range in size, from those the size of a toy poodle to the size of Alsations (Grant 1989, 145). Dogs of a large size were also found at Haddon and Orton Hall Farm. They were most probably used as herding animals and guard dogs. One cat bone was recovered from the site but due to its fragmentation no further information can be gained about the animal.

Deer

Three fragments of Roe deer were recovered from the site. These included a tooth, a semi-worked metapodial and a fragment of cast antler which displayed signs of working at the tip. These fragments indicate that deer played a minor role in the economy at Barnwell. The presence of the tooth and metapodial suggest that deer were occasionally consumed on the site but this appears to have been a rare occurrence. This fits with the patterns from other sites in the Nene Valley and in general with Roman sites within Britain, where wild animal remains are very scarce, with antler often being the only find.

Birds

Domestic fowl

A total of four chicken bones were recovered and with such a limited sample little else can added other than chickens were present at the site as they were at many sites in the Roman period.

Geese

Geese bones were more common than domestic chicken bones, with a total of 10 fragments being recovered, including a proximal humerus displaying signs of butchery, suggesting that they were eaten on the site. The question of whether the geese were hunted from the wild or were domestic is very difficult to answer, as there are no distinct morphological differences between the domestic birds and their wild ancestral species, the grey lag goose (*Anser anser*). Domestic geese are known to have been kept by the Egyptians, Greeks and Romans, and they may have been domesticated as far back as the 3rd millennium BC, but it may well be that the Romans simply fattened birds captured from the wild. Of 190 Roman sites surveyed in central Britain only 60 have produced bones from geese. Evidence from other sites, such as Elms Farm, suggests that ducks were more commonly caught and eaten than geese. This is in contrast with early Saxon sites where geese clearly predominate over ducks. This high presence of geese bones in contrast with chicken bones would appear to set Barnwell slightly apart from the other sites in the region, all of which report very low numbers of geese bones. However, there were three large pits which may have been used as ponds at the site, making it ideal for ducks and geese. It also needs to be remembered that the sample from Barnwell is very small and that there was no sieving carried out on the site. This may have caused a bias towards the larger geese bones rather than the bones of chicken and ducks.

Wild birds

There were two bones recovered that come from wild bird species: a woodcock humerus and an ulna from a member of the *Corvidae* family (most probably a crow). The woodcock bone may be seen as evidence of woodcocks being eaten on the site as they provide good meat and have been recorded at other sites, such as Great Holts Farm, with butchery marks on them. They are also associated with sites of high status in the later Roman periods (Albarella 2003, 195). This combined with the large cattle, high numbers of geese and the presence of wild species such as Roe deer, may suggest a relatively affluent lifestyle for the inhabitants of Barnwell.

Fish

Only one fish bone was recovered; almost certainly due to the bias in the data produced by the lack of sieving for smaller bones. The bone was from a member of the *Salmonidae* family, most

probably from a pike. Pike remains have also been found at other Roman sites such as Lincoln and Elms Farm. The presence of fish indicates the exploitation of local fresh water resources, most probably the River Nene.

Bibliography: Animal bone

- Albarella, U, 2003 Zooarchaeological evidence: Animal bone, in M German, 2003, *Excavations at Great Holts Farm, Boreham, Essex, 1992-1994*, East Anglian Archaeol, **105**, 193-200
- Armitage, P L, & Clutton-Brock, J, 1976 A system for classification and description of horn cores of cattle from archaeological sites, *Journal of Archaeological Science*, **3**, 329-348
- Bartosiewicz, L; Van Neer, W, & Lentacker, A, 1997 Draught cattle: their osteological identification and history, *Musee Royal de l'Afrique Central. Tervuren, Annales Sciences Zoologique*, **281**
- Baxter, I, 2003 Fauna and Flora: the mammal and bird bones, in Hinman, 2003, *A late Iron Age farmstead and Romano-British site at Haddon, Peterborough*, Cambridge County Council Archaeological Field Unit Monograph, 2, BAR British series, **358**, 119-132
- Collins, P, 1994 The Animal Bone, in C A I French, *The Archaeology along the Elton-Haddon bypass, Cambridgeshire*, Cambridgeshire County Council, Fenland Archaeological Trust monograph, **2**
- Davis, S J M, 1996 Measurement of a group of adult female Shetland sheep skeletons from a single flock: A base line for zooarchaeologists, *Journal of Archaeological Science*, **23**, 593-612
- Dobney, K, Jaques, S D, and Irving, B G, 1996 *Of butchers and breeds: Report on vertebrate remains from various sites in the city of Lincoln*, Lincoln Archaeol Studies, **5**
- Dobney, K, & Reilly, K, 1988 A method for recording information about mammal bones: the use of diagnostic zones, *Circaea*, **5:2**, 79-96
- Johnstone, C, and Albarella, U, 2002 *The late Iron Age and Romano-British mammal and bird bone assemblage from Elms Farm, Heybridge, Essex*, English Heritage
- King, A, 1978 A comparative survey of bone assemblages from Roman sites in Britain, *Bulletin of the Institute of Archaeology*, **15**, 207-232
- King, A, 1984 Animal bones and the dietary identity of military and civilian groups in Roman Britain, Germany and Gaul, in Blagg & King (eds), *Military and civilian relationships in a frontier province*, BAR British Series, **136**, 187-217
- King, A, 2004 Mammal bone, in Blagg, Plouviez and J Tester, (eds) *Excavations at a large Romano-British settlement at Hancheston, Suffolk in 1973-4*, East Anglian Archaeol, **106**, 188-195
- King, J, 1996 The animal bones, in Mackreth, *Orton Hall Farm: A Roman and early Anglo-Saxon Farmstead*, East Anglian Archaeol, **76**, 216-219
- Levine, M, 1982 The use of crown height measurement and eruption wear sequences to age horse teeth, in Wilson; Grigson, and Payne (eds), *Ageing and sexing animal bones from archaeological sites*, British Archaeological Reports: British series, **109**, 223-50
- Levitan, B, 1990 *Vertebrate remains from Bancroft Villa, Milton Keynes, Bucks, 1983-86*, Ancient Monuments Laboratory Report, 58/90
- Luff, R, 1982 *A zooarchaeological study of the Roman north-western provinces*, British Archaeological Report: International Series, 137
- Maltby, J M, 1987a *The animal bones from the excavations at Owslebury, Hants. An Iron Age and Early Romano-British settlement*, Ancient Monuments Laboratory Report, **86/87**
- Maltby, J M, 1987b *The animal bones from the later Roman phases from Winchester northern suburbs: 1: The unsieved samples from Victoria Road trenches X-XVI*, Ancient Monuments Laboratory Report, **125/87**
- O'Connor, T P, 1988 Bones from the General Accident site, Tanner Row, *The Archaeology of York*, **15** (2), 16-136
- Payne, S, 1987 Reference codes for wear stages in mandibular cheek teeth of sheep and goats, *Journal of Archaeol Science*, **12**, 139-147

- Payne, S, 1972 Kill-off patterns in sheep and goats: the mandibles from Asvan Kale, *Anatolian Studies*, **23**, 281-303
- Teichart, M, 1975 Osteometrische Untersuchungen zur Berechnung der Widerristhöhe bei Schafen, in Clason (ed) *Archaeological Studies*, 51-69, Amsterdam, Elsevier
- Von den Driesch, A, 1976 *A guide to the measurement of animal bones from archaeological sites*, Peabody Museum Bulletin, **1**, Cambridge Mass, Harvard University
- Von den Driesch, A, & Boessneck, J, 1974 Kritische Anmerkungen zur Widerristhöhenberechnung aus Langenmassen vor und frühgeschichtlicher Tierknochen, *Saugetierkundliche Mitteilungen*, **22**, 325-348

Appendix 1: Descriptions of Sections

Pit III Sections (Fig 13)

Section A-B

- 1 Grey-brown clayey loam
- 20 Grey clayey loam
- 40 Green-grey clayey loam with some yellow mottling
- 14 Dark grey-black clayey loam + large limestone block and building debris
- 46* Grey-yellow clayey loam + heavy concentrations of building materials
- 44 Dark grey clayey loam + sandy inclusion
- 43 Black peaty layer
- 41 Blue-grey clay, may be side slip within pit
- 42 Black organic layer, primary silting within pit

Section B-C

- 1 Grey-brown clayey loam
- 3 Black-grey clayey loam
- 8 Black-grey clayey loam
- 14 Grey-brown silty clay
- 15* Grey-brown silty clay, part waterlogged
- 25 Light grey clayey loam + ash
- 26 Grey-brown clayey loam + yellow clay inclusions + charcoal flecks + heavy concentration of limestone and other building materials
(as 33 in sections C-D and D-E below)
- 28 Brown-grey clayey loam + tile and limestone
- 29 Brown-grey clayey loam + black organic inclusions
- 30 Black organic layer, primary silting of pit

Section C-D

- 1 Grey-brown clayey loam
- 5 Black-grey clayey loam
- 9 Black-grey clayey loam with finer texture than + charcoal and ash
- 10 Brownish grey clayey loam
- 11 Sticky brown clayey loam + charcoal flecks
- 31 Yellow-brown clayey loam + charcoal flecks
- 33 Grey-brown clayey loam + yellow clay inclusions + charcoal flecks + heavy concentration of limestone and other building materials
(as 26 in section B-C above and 33 in section D-E below)
- 34* Sticky grey brown clayey loam + charcoal flecks and ash + building materials
- 36 Brown-grey heavy clayey loam + limestone
- 37 Brown wet deposit + organic remains
- 42 Thick layer of organic material in very fine lenses, primary silting of pit
- 43 Large baulk of timber, possibly fallen from revetment at the side of the pit to the east

* All layers below layer marked thus are part waterlogged or waterlogged.

Plan and section through pit III and bath Suite (Fig 16)

Section D-E

- + topsoil
- 2 Heavy debris of limestone, tile and pottery-destruction layer over bath suite-extended over 33 and 44. (Contained mortarium linked with other fragment from) 26
- 3 Opus signinum
- 13 Ash and limestone/tile, position of northern flue cheek
- 18 Grey clayey loam, under 44
- 19 Limestone spread seals masons trench and under 18
- 20 Masons trench
- 25 Limestone sub-flooring
- 26 Grey-brown clayey loam + yellow clay inclusions + charcoal flecks + heavy concentration of limestone and other building materials (same as 33 below)
- 33 Grey-brown clayey loam + yellow clay inclusions + charcoal flecks + heavy concentration of limestone and other building materials (as layer 26 above and layer 26 in section B-C)
- 44 Grey loam + ash + tile – under 33 and contained by wooden revetment to west, extended over wall line to east
- 46 Grey brown loam + heavy limestone packing behind wooden planking of revetment
- 47 Brown-grey clayey loam + flecks of orange clay, built up ground behind revetment, re-deposited natural?

Section through Pit I - looking west (Fig 12)

Section E-F

- + Topsoil
- 3 Dark grey silty clay
- 5 Black-grey silty clay and concentrations of limestone rubble
- 8 As 5 above but with patches of yellow /grey clay
- 12 Black silty clay
- 13 Charcoal/ash with some burnt grain
- 15 Yellowish clay with brown staining
- 27 Black organic layer, primary silting of pit

Section through Pit II – looking north (Fig 12)

Section F-G

- + Topsoil
- 9 Dark grey clay with yellow patches + charcoal fleck
- 11 Dark brown clay with orange clay patches
- 28 Grey-blue clay + charcoal flecks + limestone fragments
- 31 Grey clay + patches of orange clay and patches of pebbles
- 32 Limestone rubble in band around edge of pit and part cutting into 33
- 33 Orange clay with grey clay patches + burnt clay fragments

Sections through postholes F29 looking east & F35, looking south (Fig 8)

F 29, Section G-H

- + Topsoil
- 29 Dark grey-black loamy fill of lower post pipe
- 37 Grey loamy fill of post-pipe
- 47 Limestone packing set in grey clayey loam

F35, section H-I

- +Topsoil
- 38 Grey-black loam fill of post-pipe
- 39 Grey clayey loam with patches of yellow clay and heavy limestone packing

Section across Ditch 1, PH F36 & PH F20 (Fig 6)

Section I-J looking north

+ Topsoil

- 1 Limestone, rubble spread with pottery (last occupation deposits on the site)
- 2 Limestone rubble yard surfacing
- 3 Dark loam fill Phase 1 post hole
- 4 Limestone packing for posthole
- 5 Limestone packing for posthole
- 6 Dark loamy fill of post-pipe of Phase 2 posthole
- 7 Small limestone chips and gravel spread of Phase 2 floor within building
- 8 Brown, fine, loamy soil
- 9 Limestone packing for Phase 1 posthole
- 10 Dark brown loamy fill of Phase 1 posthole
- 11 Limestone and gravel spread with crushed pottery forming Phase 1 flooring within building
- 12 Limestone packing for Phase 1 posthole
- 13 Dark grey-brown clay fill of ditch 1
- 14 Dark grey clayey loam
- 15 Very dark grey, heavy clayey loam
- 16 Brown clayey loam
- 17 Limestone and gravel spread with crushed pottery set in brown, clayey loam

Sections looking south across Ditch 1 (Fig 5)

Section J-K

+ Topsoil

- 1 Dark grey-brown loamy clay
- 2 Dark grey clayey loam
- 7 Grey-brown clayey loam with charcoal flecks

Section K-L

+ Topsoil

- 1 Brown-grey clayey loam
- 2 Dark grey clayey loam (see 2 above)
- 3 Dark grey silty clay (see Pit 1 section, Fig12, and above for layers 3, 5 & 8 in this section)
- 5 Black-grey silty clay and concentrations of limestone rubble
- 7 Grey-brown clayey loam with charcoal flecks
- 8 As 5 above but with patches of yellow-grey clay
- 16 Grey-brown loam, filling of Ditch 16
- 32 Dark grey-brown loam

Section L-M

+ Topsoil

- 9 Brown, loamy fill with some sand inclusion
- 10 Grey-brown clayey loam with charcoal flecks (see 7 in sections J-K & K-L above)
- 11 Dark grey clayey loam

Sections of small pits 50 & 51, F100 and F102 (Fig 23)

Section M-N

+ Topsoil

- 1 Dark Brown loamy clay with limestone rubble
- 2 Brown loamy earth with some sandy inclusions
- 3 Black ash with some burnt grain
- 4 Brown-grey loamy clay
- 5 Dark brown sandy loam
- 6 Dark Brown-black loam with some ash

Section N-O

+ Topsoil

- 2 Brown-grey loam with limestone, tile and general building rubble
 - 3 Brown loam
 - 4 Fine dark brown loam with some ash
- F101 Spread of ash and dark brown loam

Section O-P

+ Topsoil

- 2 Brown-grey loam with limestone, tile and general building rubble
- 3 Brown loam

Sections of postholes along the north-west wall line of the aisled building (Fig 15)

All Sections P-Q/1-5

+ Topsoil

- 8-12 Brown clayey loam with limestone packing

Sections of Ditch 6 and wall line 4 (Fig 11)

All Sections Q-R/1-3

+ Topsoil

- 6 Light brown loam with limestone fragments

All Sections R-S/1-3

+ Topsoil

- 3 Brown loam with some sand and gravel inclusion
- 4 Limestone fragments forming remains of Wall 4
- 6 Light brown loam with limestone fragments of underlying Ditch 6
- 8 Light brown mixed loam with small limestone chips and some gravel
(Wall 4 foundation trench)

Sections S-T of postholes forming a fence line to the east of Pit 1 (Fig 22)

All Sections S-T/1-4

+ Topsoil

- 7 Grey-brown clayey loam (part of Ditch 1)
- 17 Brown-grey loam with limestone packing
- 21 As above
- 22 As above
- 40 As above

Sections through the wall line of the Aisled Building in the S-W corner (Fig 9)

All Sections T-U/1-2

+ Topsoil

5 Limestone and gravel

17 Limestone and gravel spread of yard to west of building

64 Brown loam with limestone packing for posthole

68 As above

Appendix 2: Catalogue of the coins from Barnwell Lodge Farm

SF NO	Area	Denomination	Status	Date	Ruler	Obverse legend	Reverse description	Reverse legend	Mintmark	Reference
49	D+	Nummus	Copy	355-361	Constantius II	illegible	Soldier stabbing fallen horseman	[FEL TEMP REPARATIO]		
58	D+	Nummus	Regular	364-378	House of Valentinian	illegible	Victory advancing left with wreath	[SECVRITAS REIPVBLICAE]		
68	C+	Radiate	Regular	275-296	275-296	illegible	illegible	illegible		
72	C1	Radiate	Regular	260-296	uncertain	illegible	illegible	illegible	illegible	
74	C+	Radiate or nummus	Uncertain	260-402	uncertain	illegible	illegible	illegible		
75	C14	Nummus	Regular	364-378	House of Valentinian	illegible	Victory with wreath advancing left	[SECVRITAS REIPVBLICAE]		
79	C+	Radiate	Copy	275-285	Tetricus I	[...]P TET[...]	Spes advancing left	Illegible		
82	C5	Radiate	Regular	269-274	Tetricus I or Victorinus	[...]VG	Victory left	[VICTORIA AVG]		
83	C7	Nummus	Copy	330-348	House of Constantine	illegible	Victories with wreaths	illegible		
87	C	Radiate	Regular	271-274	Tetricus I	illegible	illegible	illegible		
88	C+	Nummus	Regular	364-378	Valens	illegible	Victory with wreath advancing left	[SECVRITAS REIPVBLICAE]		
90	D+	Radiate or nummus	Uncertain	260-402	uncertain	illegible	illegible	illegible		
91	D14	Radiate or nummus	Uncertain	260-402	uncertain	illegible	illegible	illegible	illegible	
96	D14	Nummus	Regular	337-341	Theodora	[...]THEO[...]	Pietas right with infant at breast	PIETAS ROMANA	(Trier)	
106	C4	Radiate	Copy	275-285	Tetricus I	[...]TET[...]	illegible	Illegible		
107	D14	Nummus	Regular	335-337	Constantius II as Caesar	FL IVL CONS[...]	Two soldiers, one standard	GLORIA EXERCITVS	TRS	RIC Vol. VII, 586-87
110	E29	Nummus	Regular	330-331	Constantine II	[...]INVS IVN NOB C	Two soldiers, two standards	GLORIA EXERCITVS	TRS	RIC Vol. VII, 525-8
111	C21	Radiate	Regular	260-268	Gallienus	[...]NVS AVG	illegible	illegible		
112	E29	Radiate	Regular	272-274	Tetricus II	illegible	illegible	illegible		
115	E29	Nummus	Regular	367-378	Gratian		Emperor right with spear and shield	illegible		
120	C41	Nummus	Regular	364-378	House of Valentinian	illegible	Victory advancing left with wreath	[SECVRITAS REIPVBLICAE]		
126	E21	Nummus	Copy	330-335	House of Constantine	[CONSTANTINOPOLIS]	Two soldiers, two standards	[GLORIA EXERCITVS]		
127	E+	Nummus	Regular	343-348	House of Constantine	illegible	Two Victories with wreaths	VICTORIAE DD AVGG Q NN		

A ROMAN FARMSTEAD AT NORTH LODGE, BARNWELL

SF NO	Area	Denomination	Status	Date	Ruler	Obverse legend	Reverse description	Reverse legend	Mintmark	Reference
135	E14	Nummus	Regular	330-348	House of Constantine	CONSTANTINOPOLIS	Victory on prow		.PL[...]	
136	E6	Sestertius	Regular	98-117	Trajan	[...]ANO AVG [...]	illegible	illegible		
153	E36	Radiate	Regular	260-296	uncertain	illegible	illegible	illegible		
156	E30	Radiate or nummus	Uncertain	260-402	uncertain	illegible	illegible	illegible		
162	E21	Radiate	Regular	271-274	Tetricus I	[...]VS PF AVG	Laetitia left	LAETIT[...]		
164	G1	Radiate or nummus	Uncertain	260-402	uncertain	illegible	illegible	illegible		
167	no info	Radiate	Regular	271-274	Tetricus I	[...]TETRICVS PF AVG	Victory with wreath advancing left	[...]E[...]		
168	no info	Radiate	Copy	275-285	Claudius II	DIVO CLAVDIO	Altar	CONSECRATIO		
176	U/S	Radiate or nummus		260-296	uncertain	illegible	illegible	illegible		
182	F8	Nummus		364-378	House of Valentinian	illegible	Emperor advancing right with standard dragging captive	GLOR[IA ROMANORVM]		
118	E29	Nummus		335-341	House of Constantine	illegible	Soldiers, one standard	[GLORIA EXERCITVS]		
108	E29	nummus		306-317	House of Constantine	illegible	Sol advancing left	SOL INVICTO COMITI		
138	D?	Radiate	Copy	275-285	Claudius II	illegible	illegible	[...]AVG		
170	U/S	Radiate	Copy	275-285	uncertain	illegible	illegible	illegible		
165	no info	Nummus	Copy	330-348	House of Constantine	CONSTANTINOPOLIS	Victory on prow			
104	no info	Radiate or nummus		260-402	uncertain	illegible	illegible	illegible		
114	E29	Radiate		260-269	Postumus	[...]POS[...]MVS PF AVG	Jupiter with sceptre and thunderbolt	IOVI VICTORI		