

# Hartshill 1960

## KILN 2

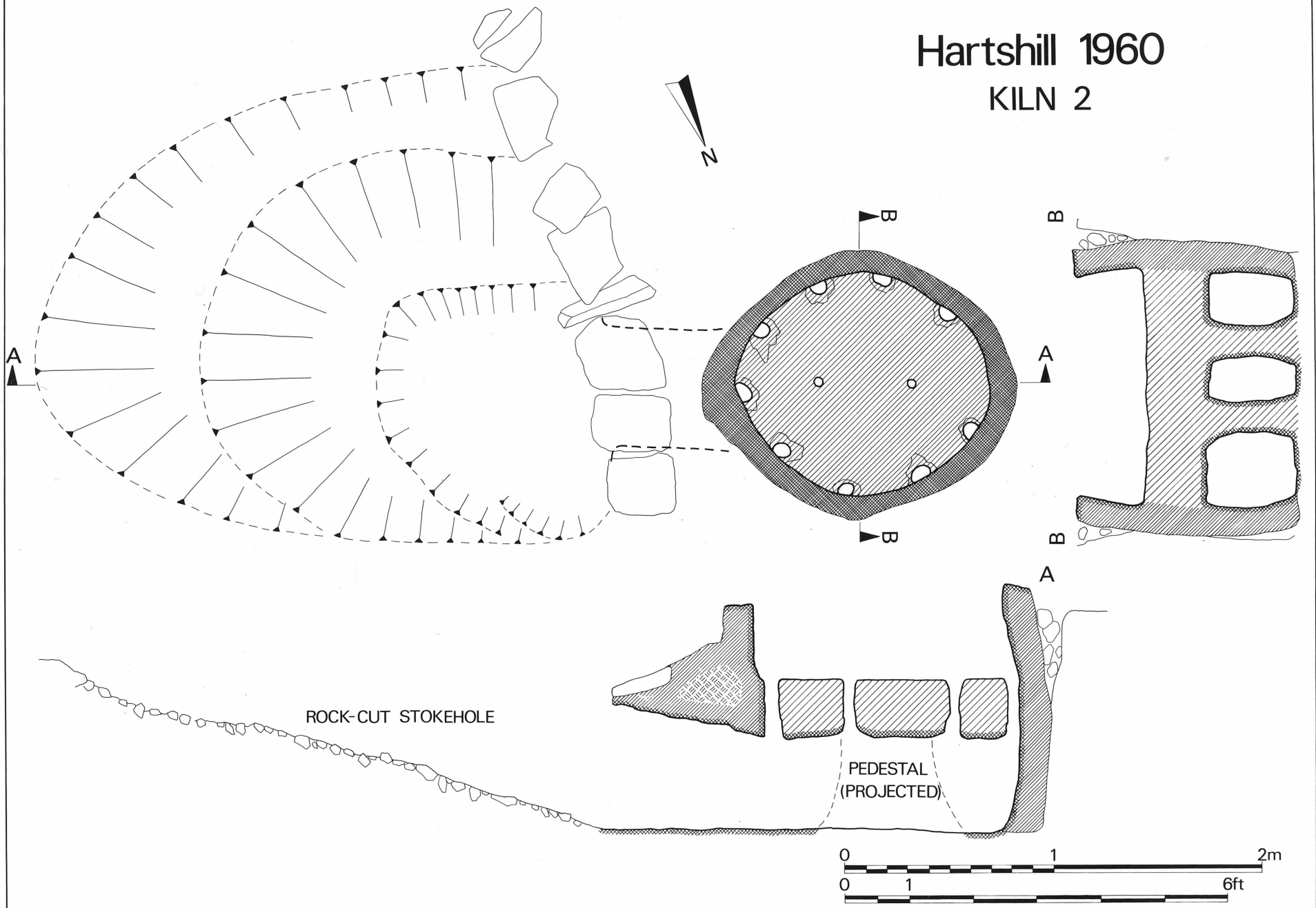

ROCK-CUT STOKEHOLE

PEDESTAL  
(PROJECTED)

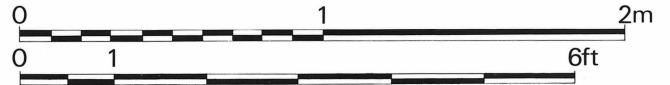

# Hartshill 1960

## KILN 3

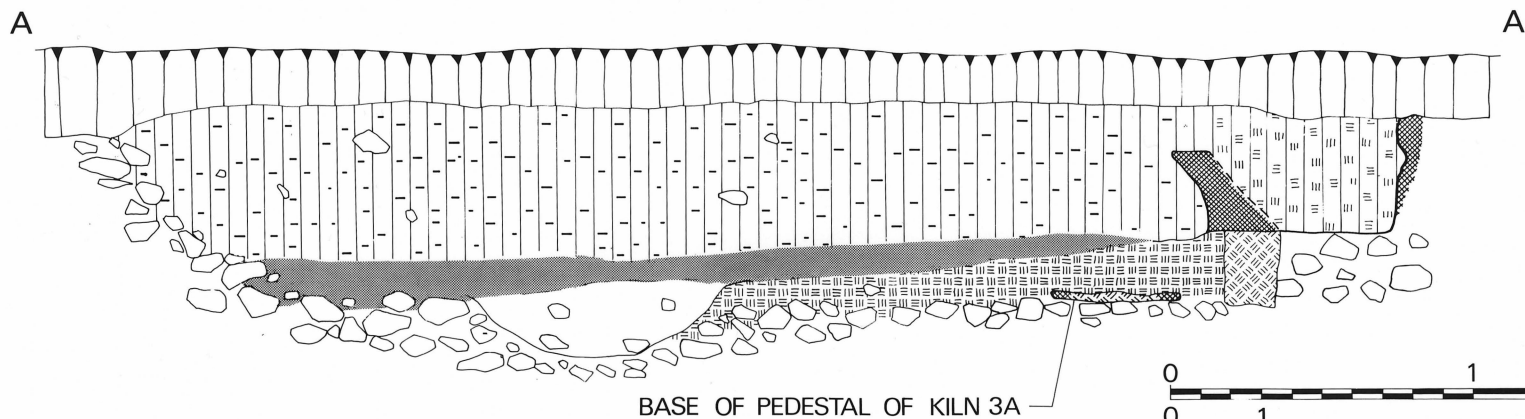
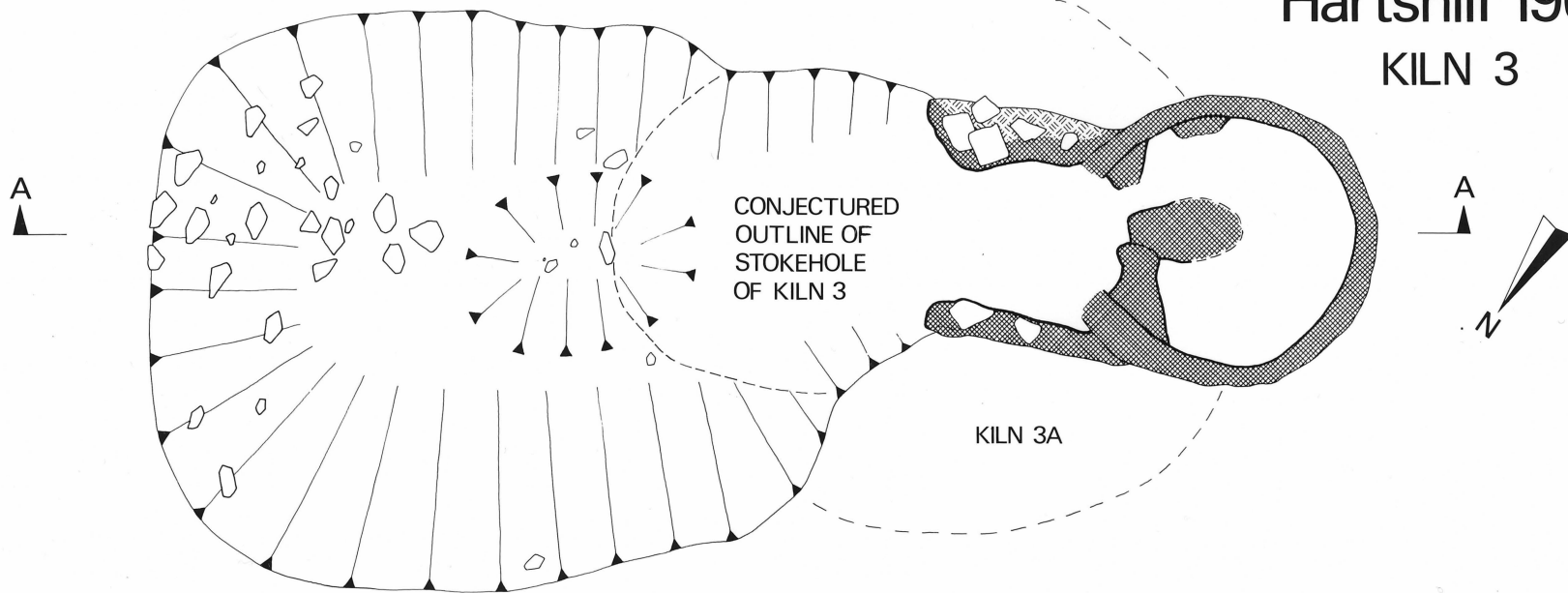

# Hartshill 1960

## KILN 3A

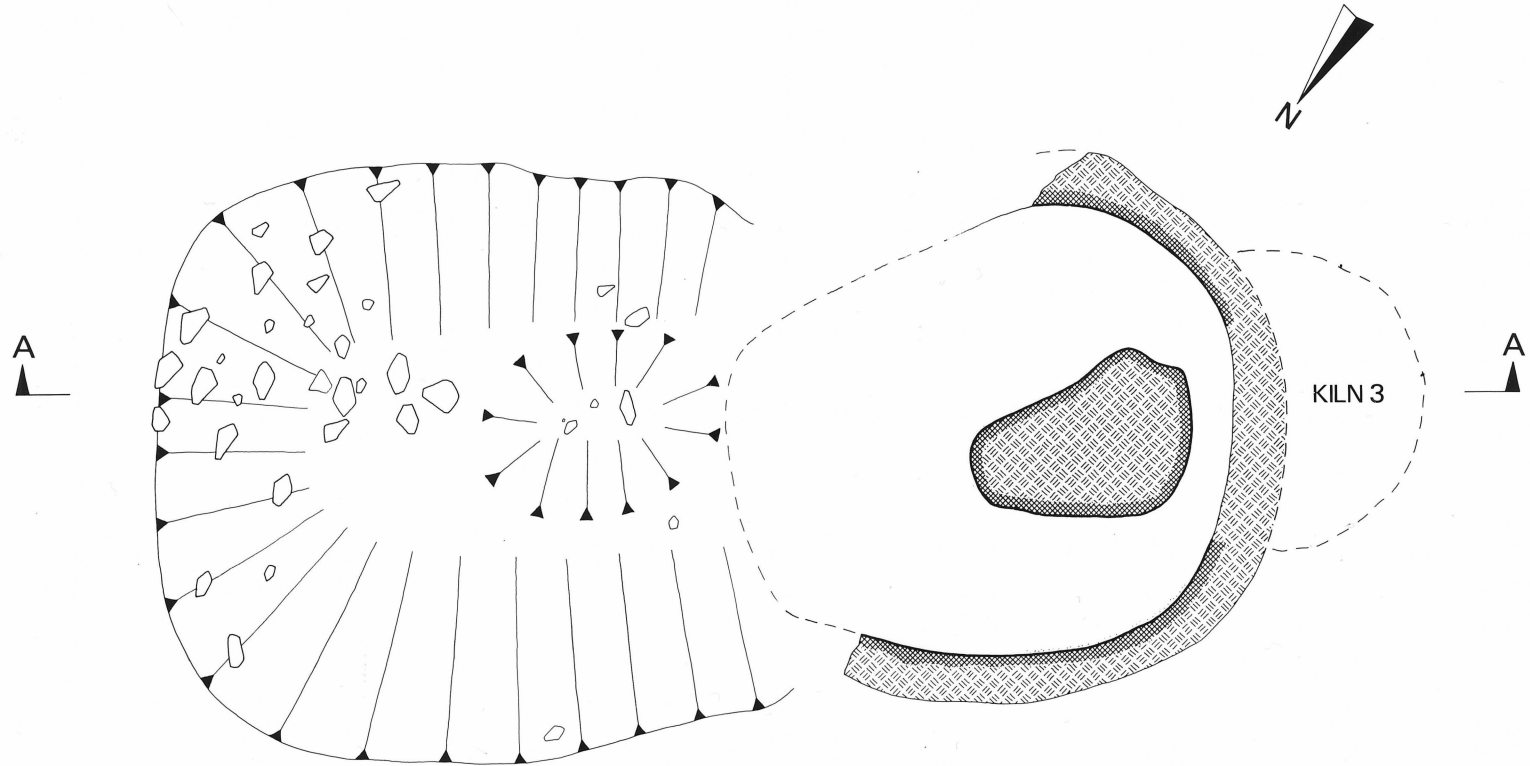

NOTE: FOR SECTION AA SEE KILN 3

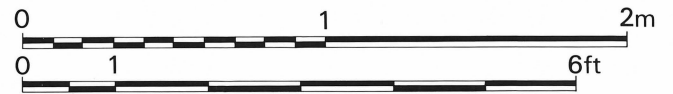

Hartshill 1960

KILN 4

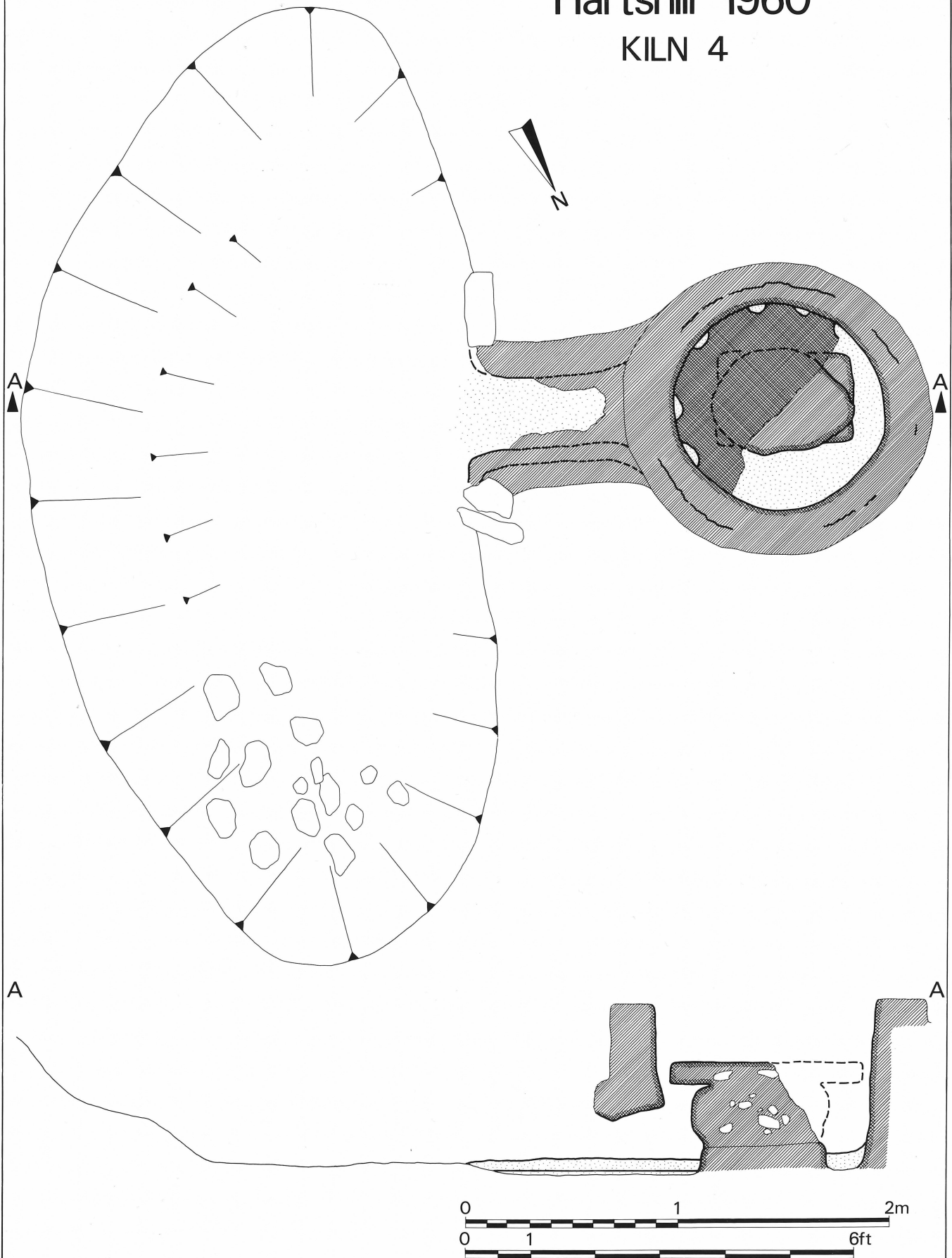



# Hartshill 1960

## KILNS 5-5B

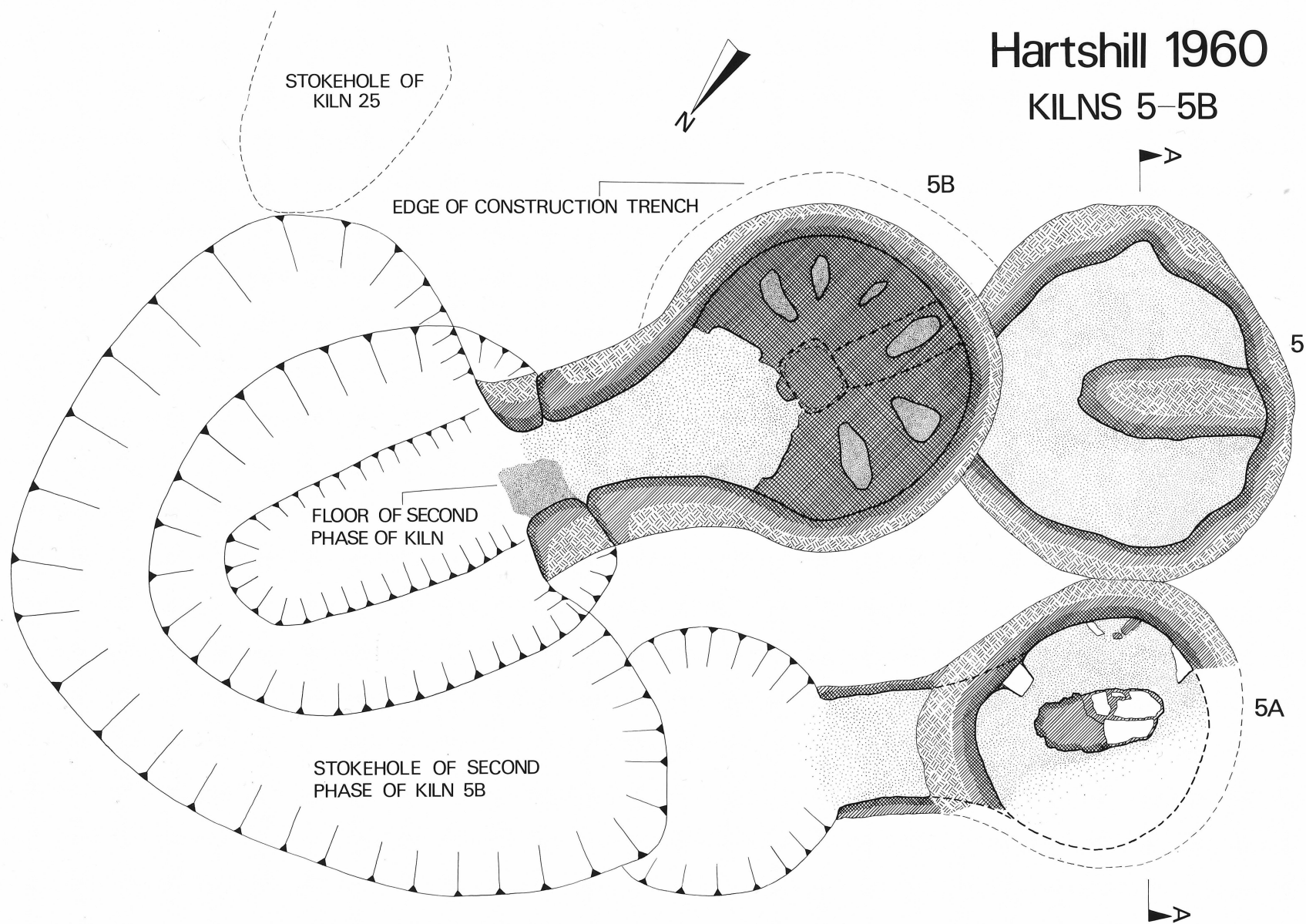

NOTE: FOR SECTIONS SEE KILN 25



# Hartshill 1961

## KILN 11

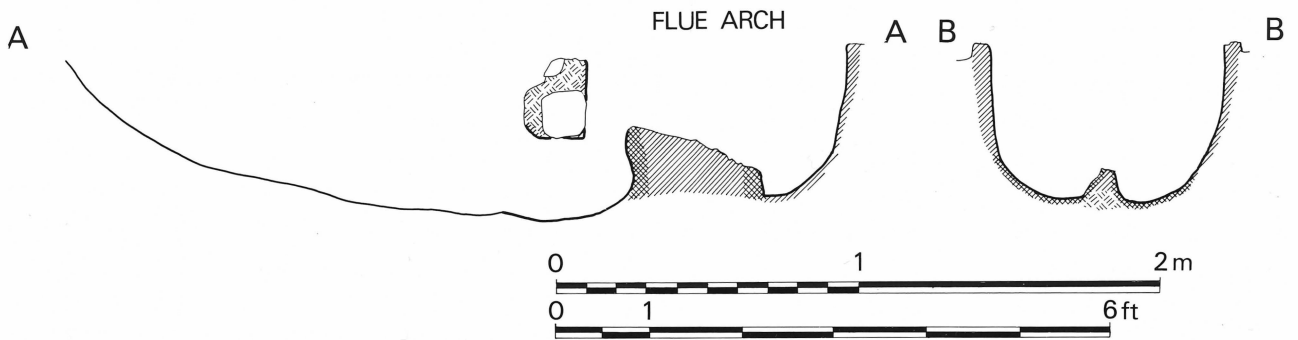
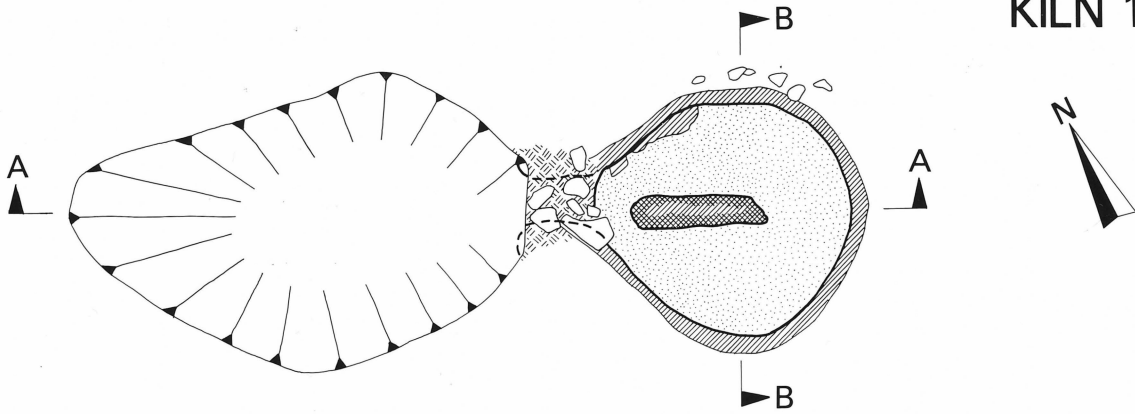

# Hartshill 1961

## KILN 12

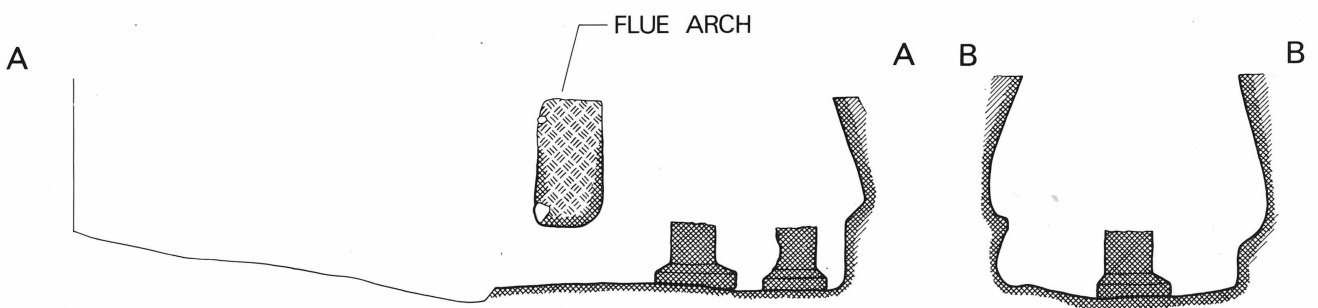
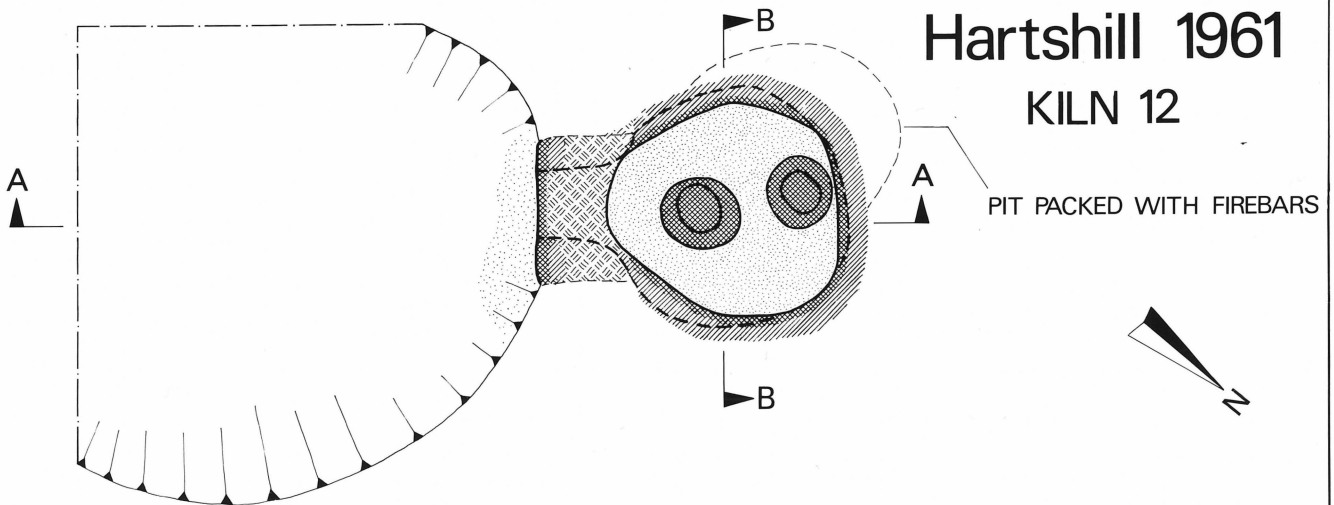

# Hartshill 1961

## KILNS 14/14A

STONE FIREBAR  
SUPPORTS

PLAN AFTER REMOVAL OF FLOOR

VITRIFIED STONE

KILN 14A

KILN 14

FLUE ARCH

STONE FIREBAR  
SUPPORT

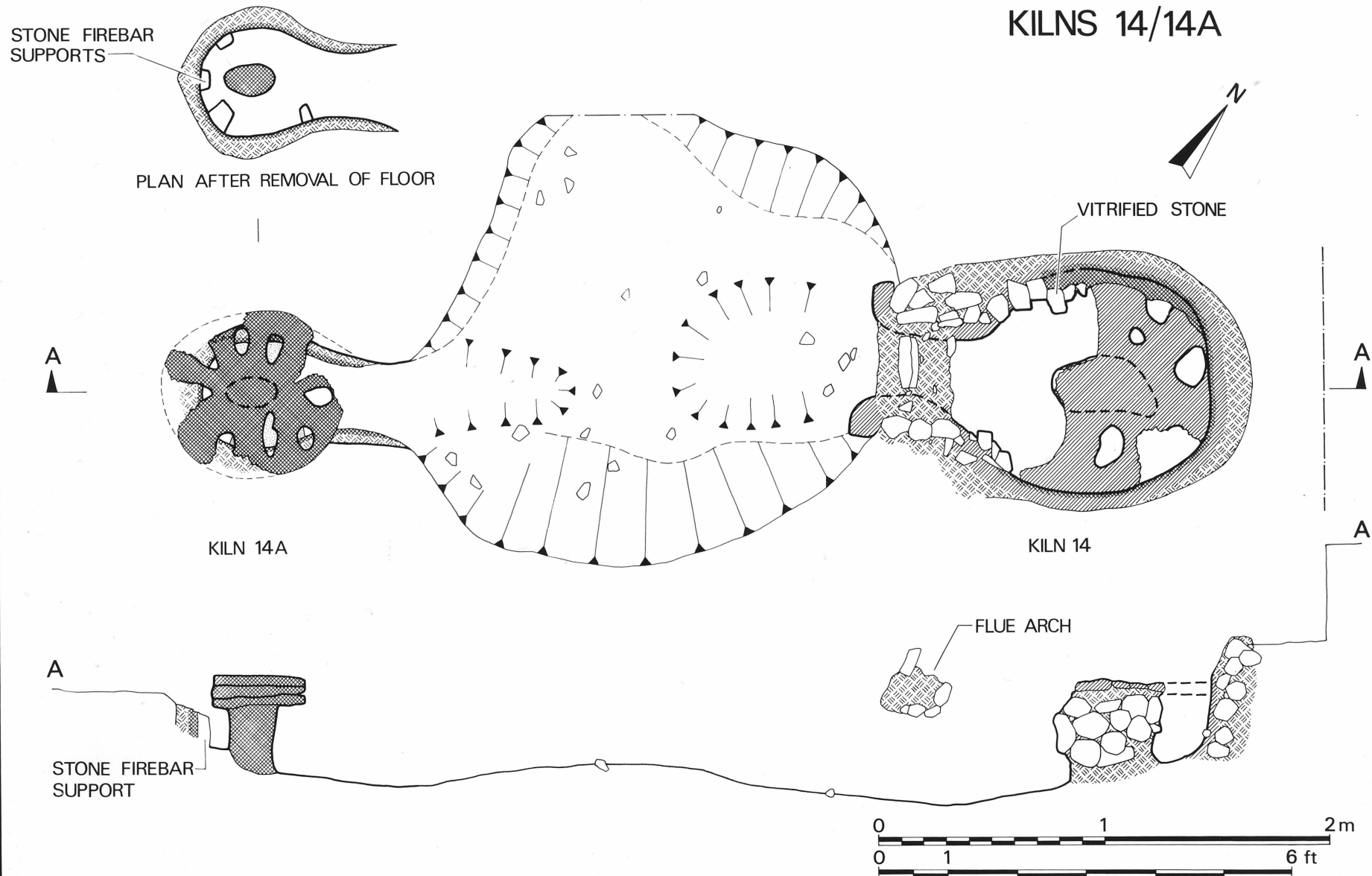

# Hartshill 1960

## KILN 16

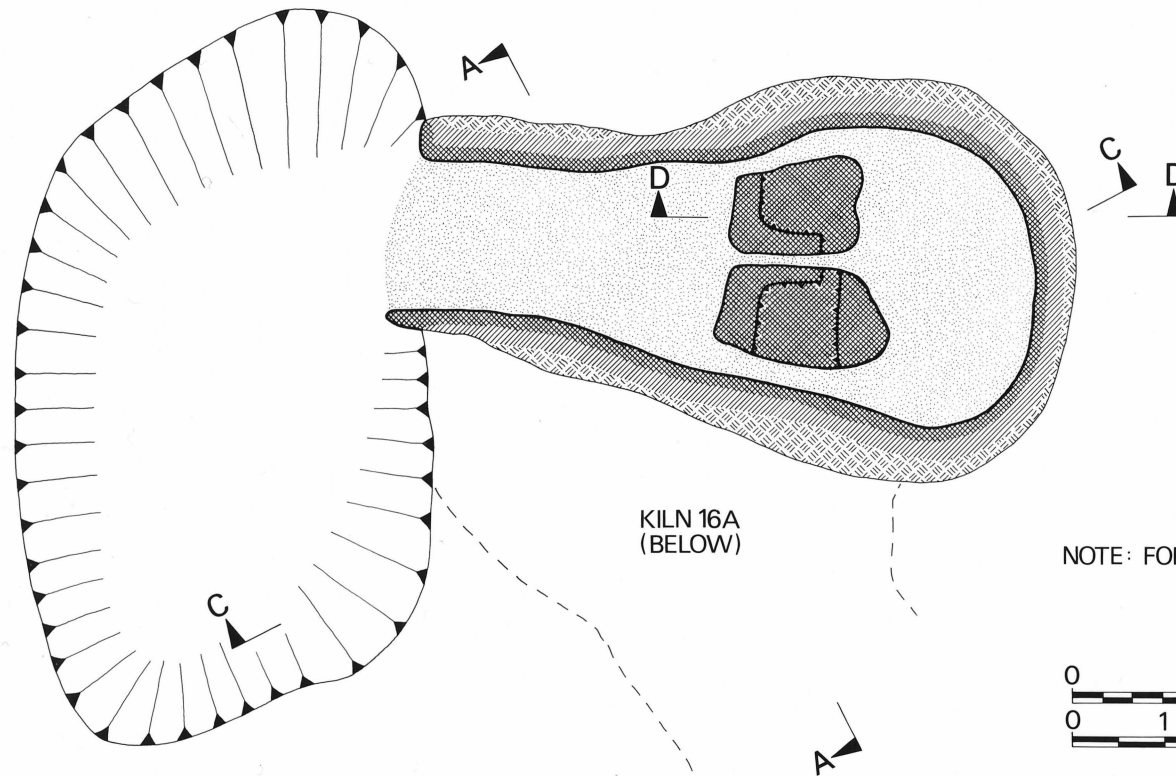

KILN 16A  
(BELOW)

NOTE: FOR SECTION AA SEE KILN 16A

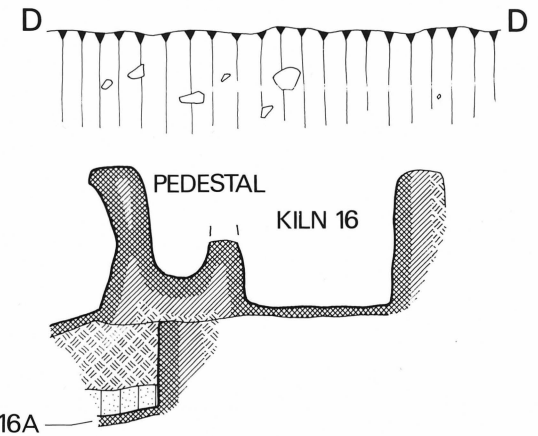
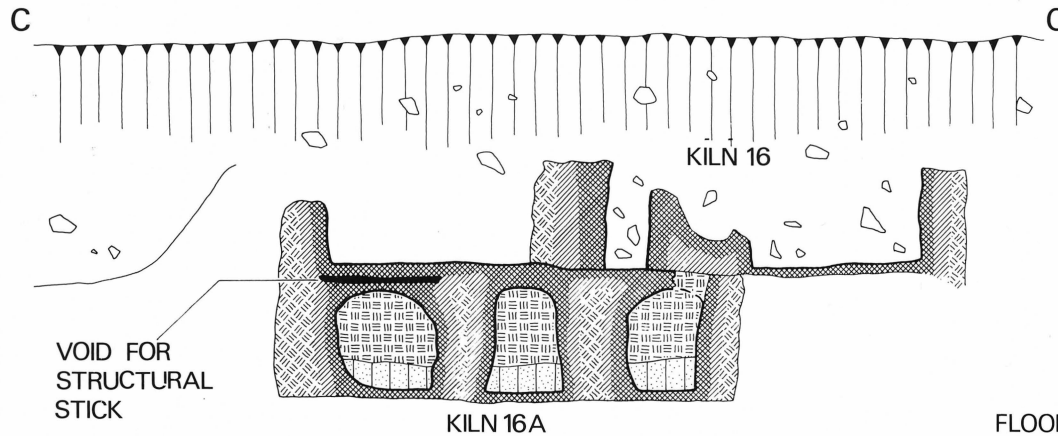
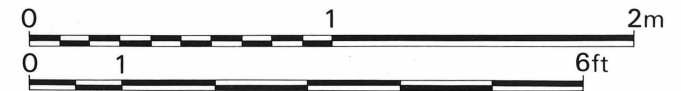

# Hartshill 1960

## KILN 16A

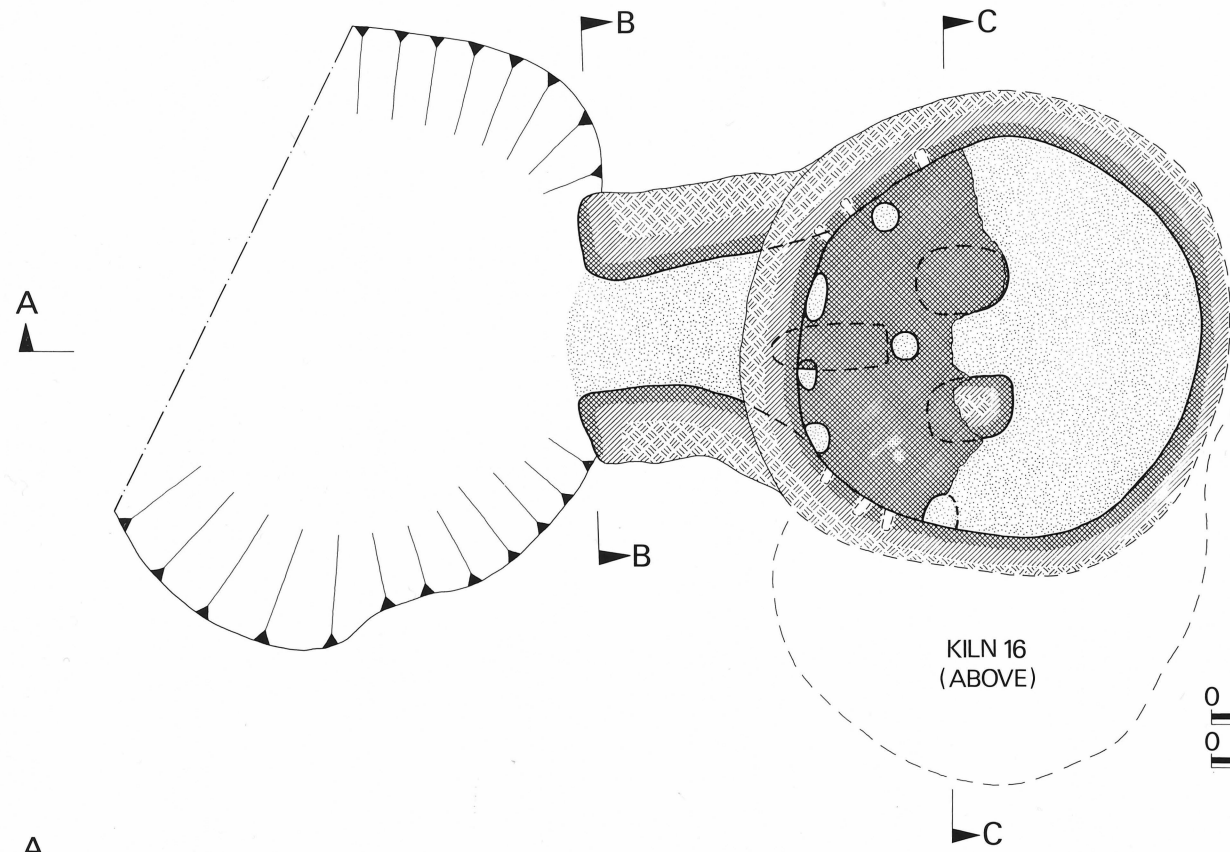

NOTE: FOR SECTION CC SEE KILN 16

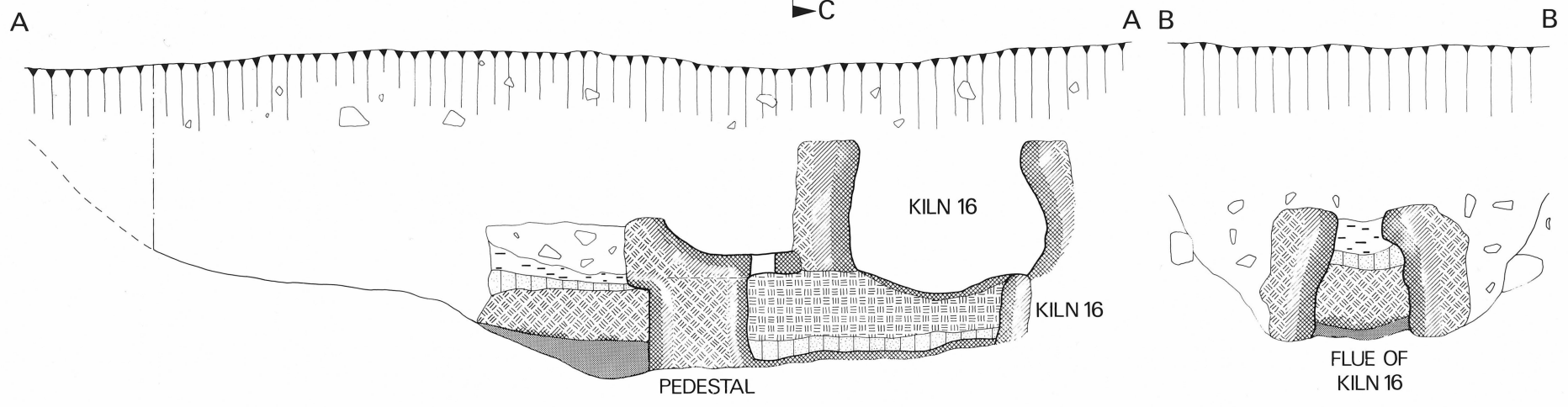

# Hartshill 1960

## KILN 18

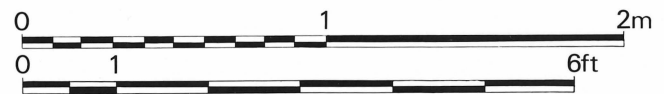
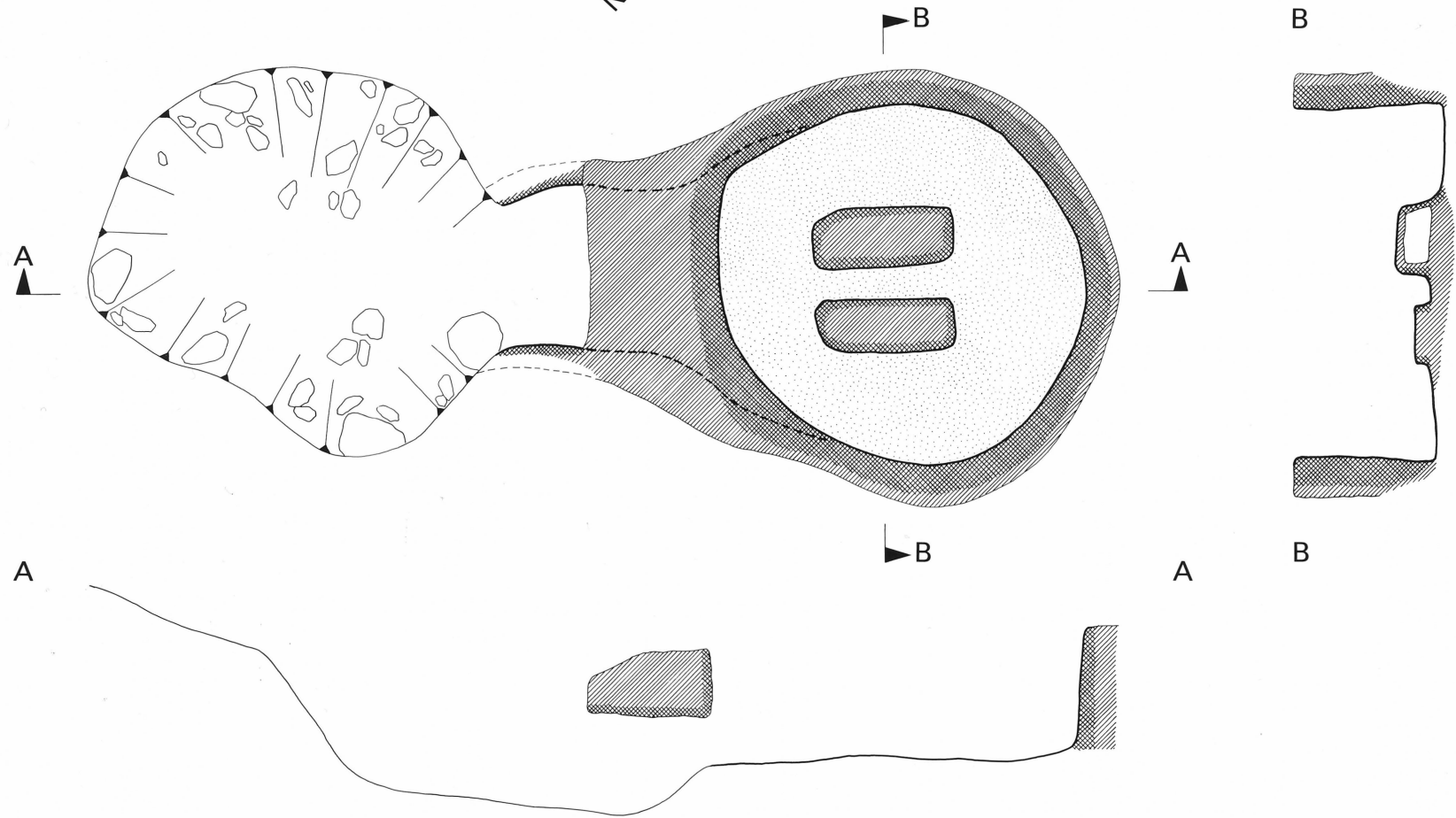

# Hartshill 1961

## KILNS 19/19A

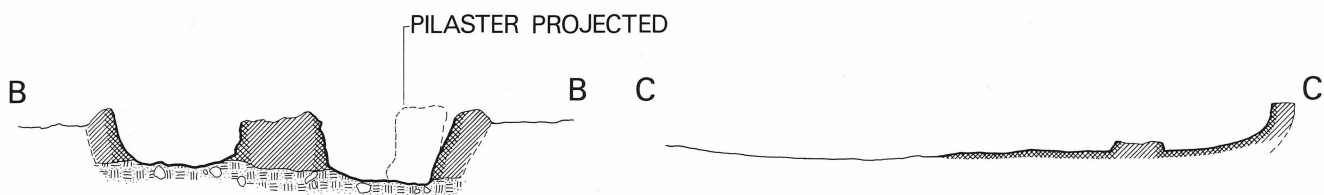
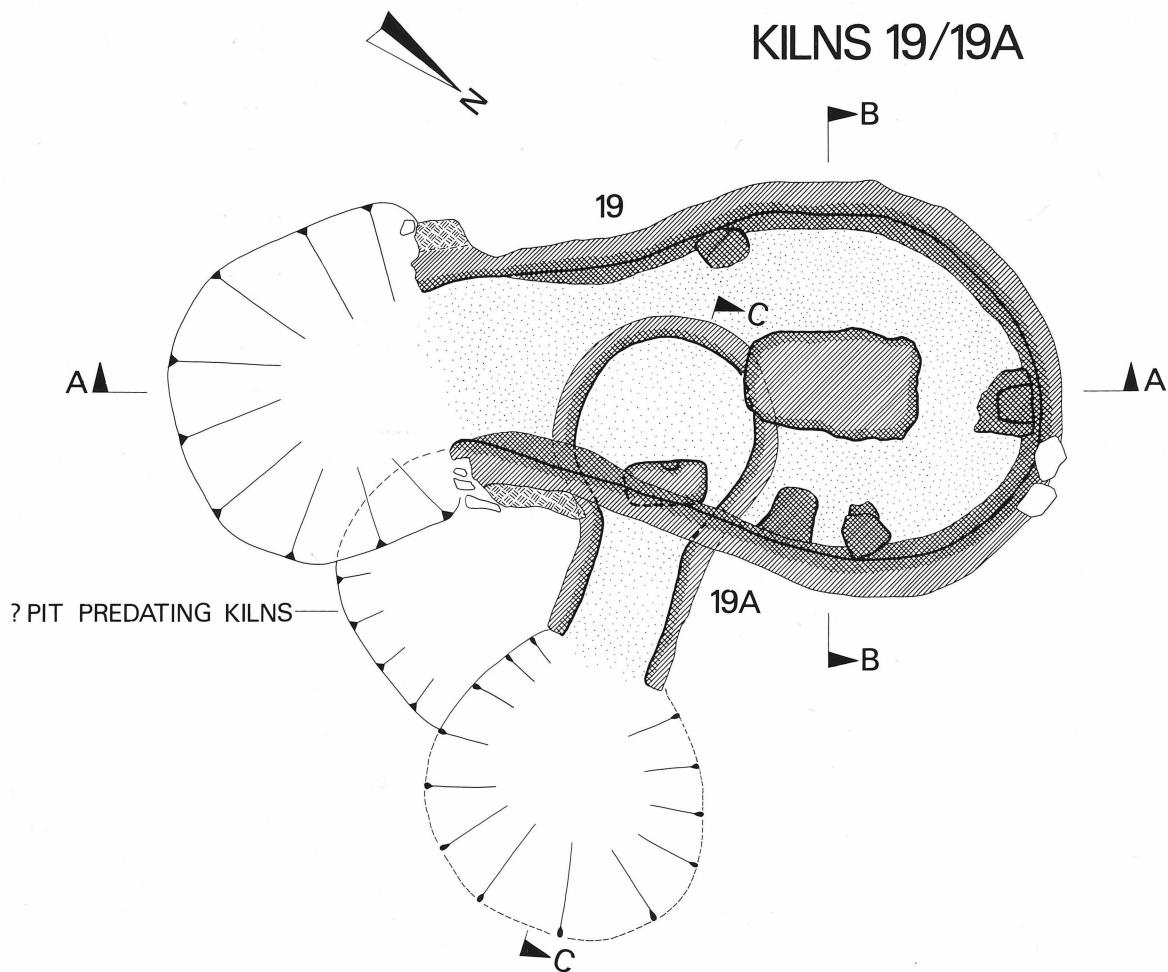

# Hartshill 1961

## KILN 28

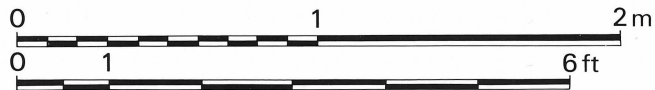
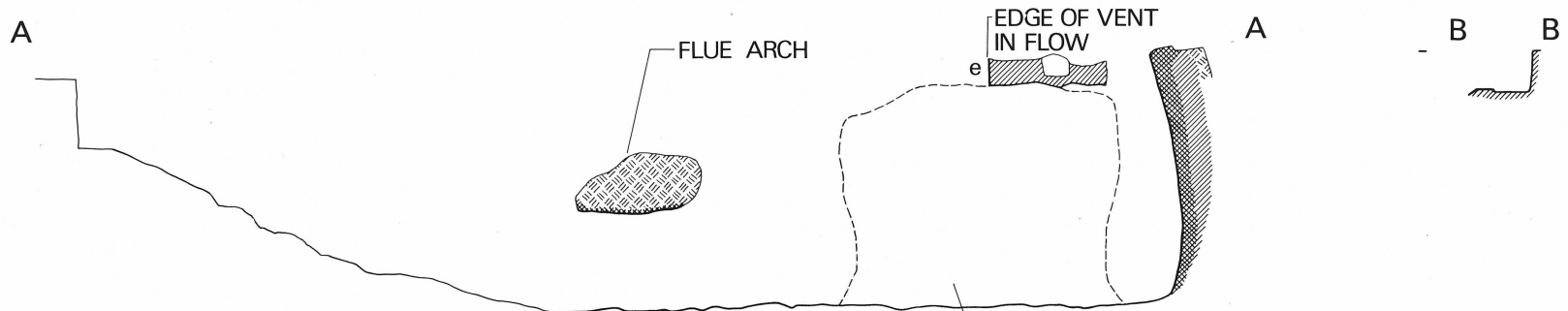
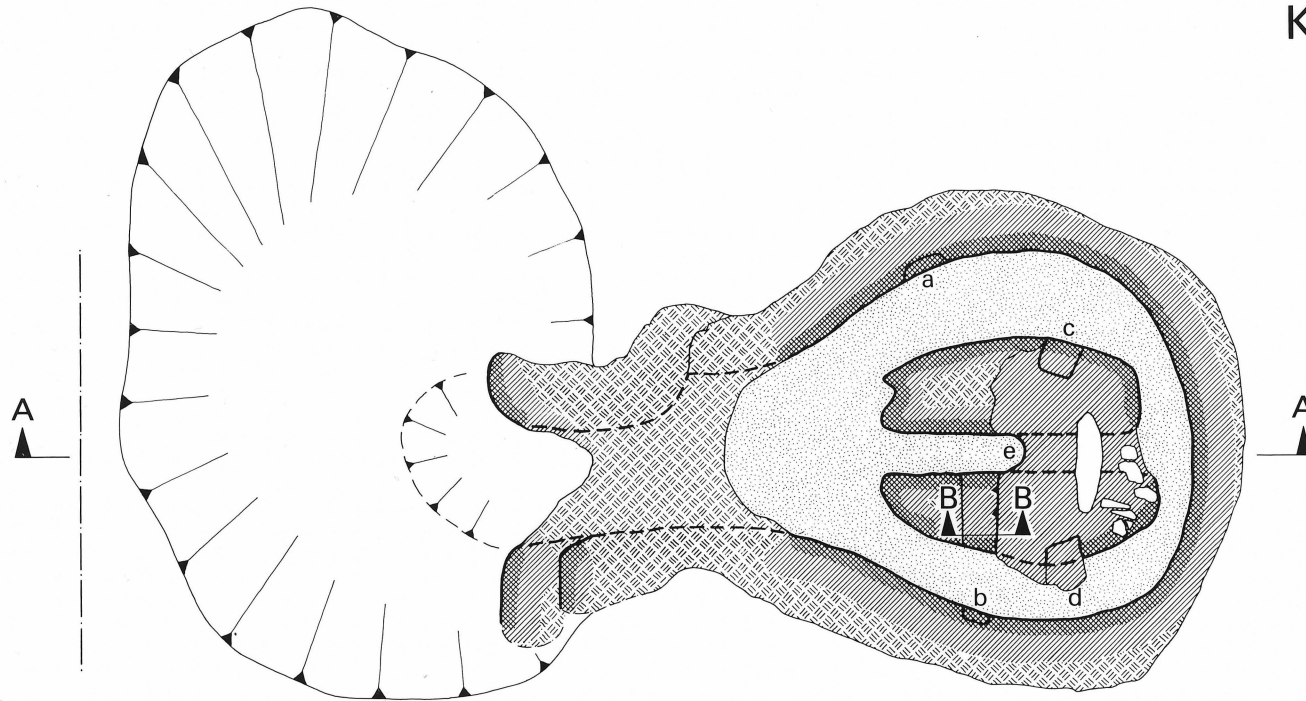

NOTE: PEDESTAL PROJECTED INTO SECTION



Hartshill 1961

KILN 31

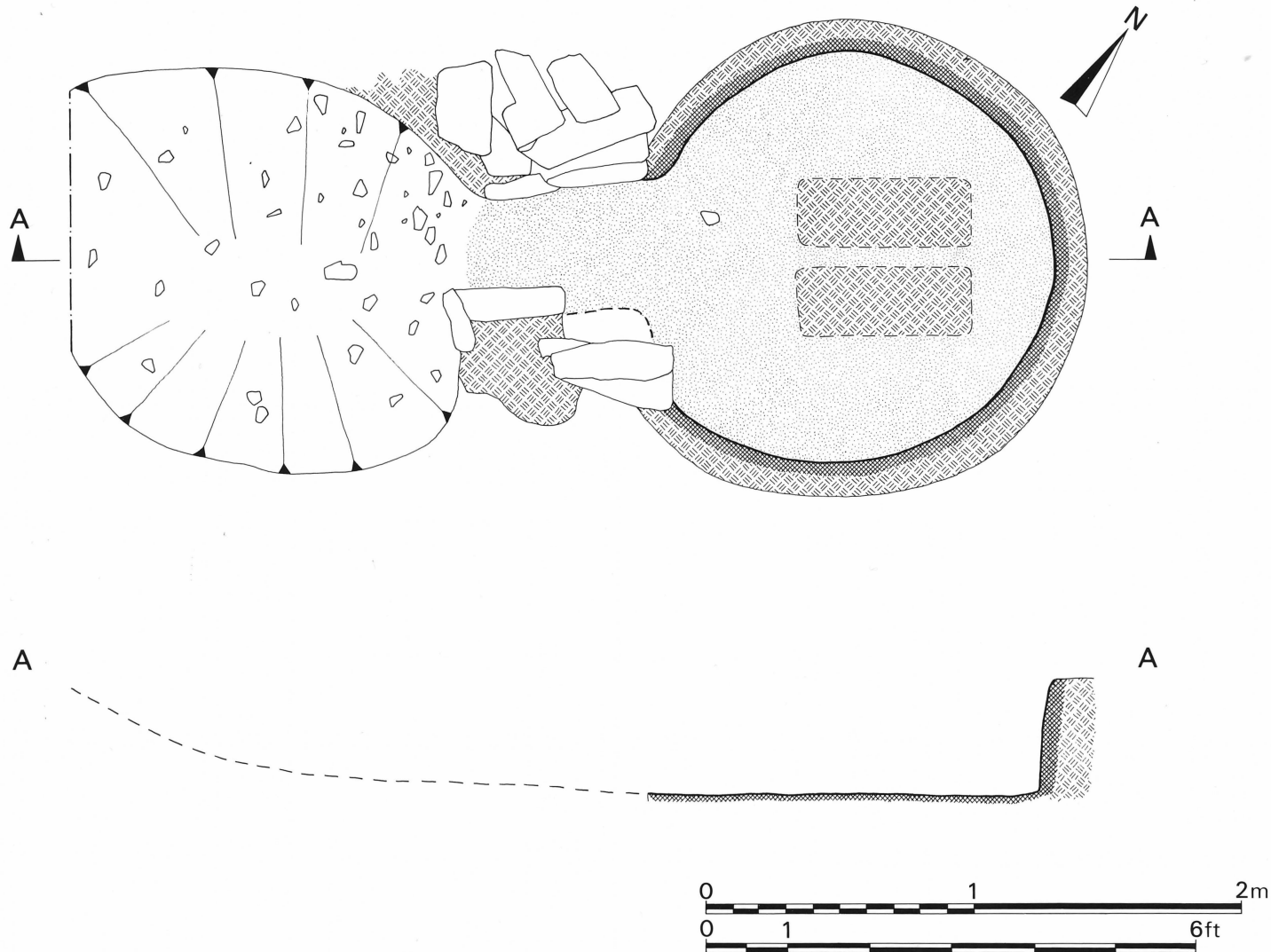

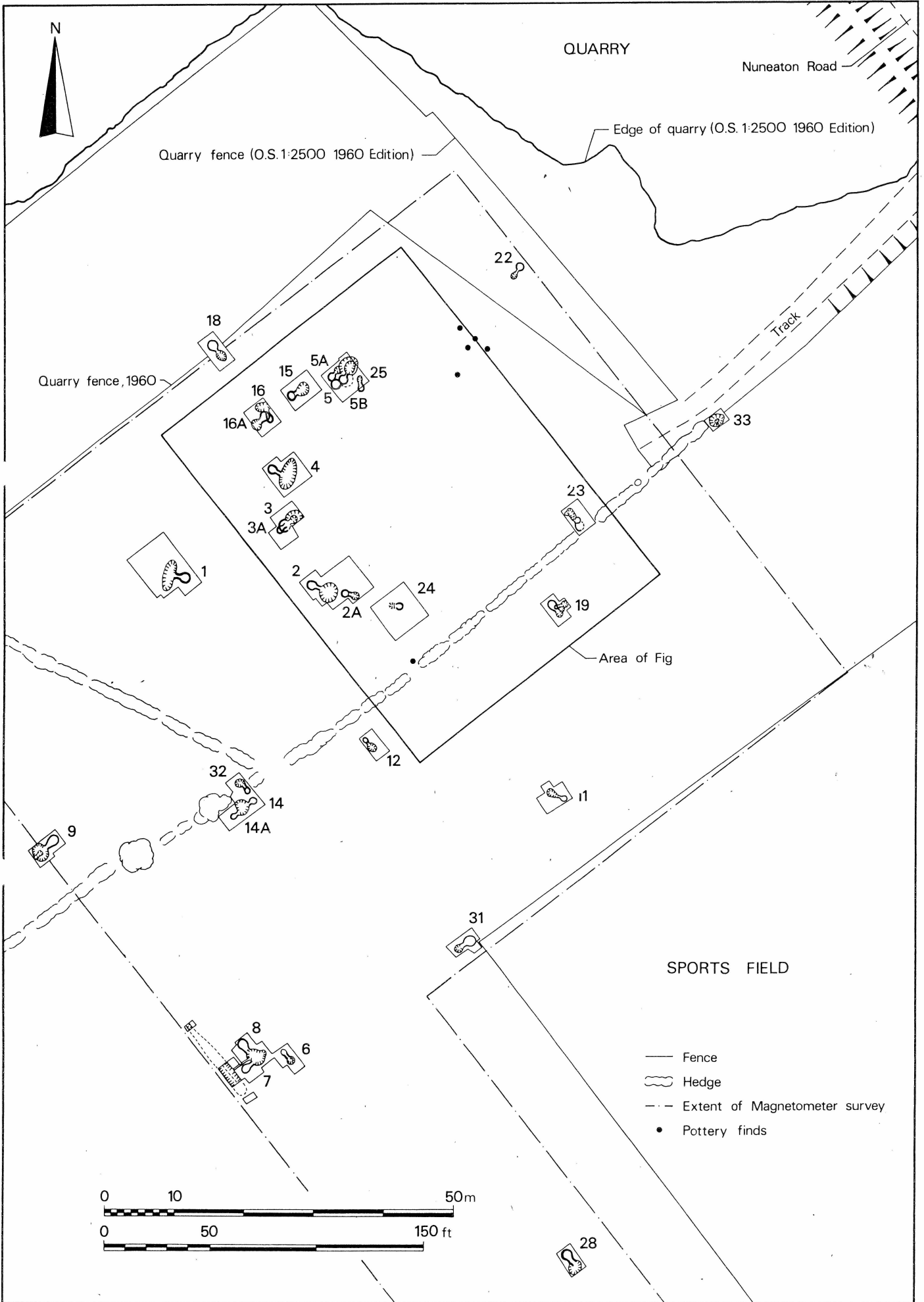

QUARRY

Nuneaton Road

Edge of quarry (O.S. 1:2500 1960 Edition)

Quarry fence (O.S. 1:2500 1960 Edition)

Quarry fence, 1960

Track

Area of Fig

SPORTS FIELD

- Fence
- ~ Hedge
- - - Extent of Magnetometer survey
- Pottery finds

