

MC 83 SF \triangle

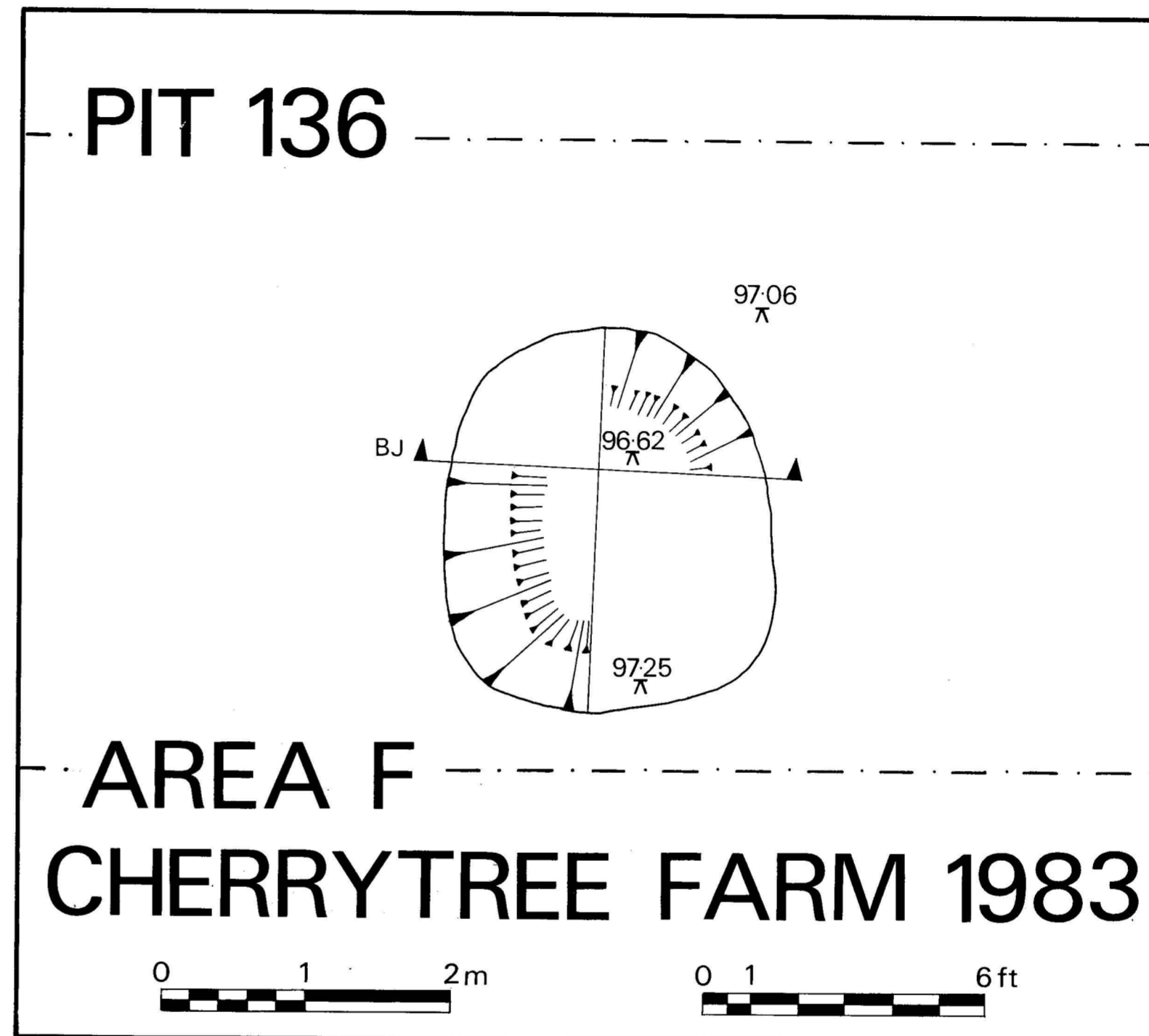

Cherrytree Farm 1983

KILN 1

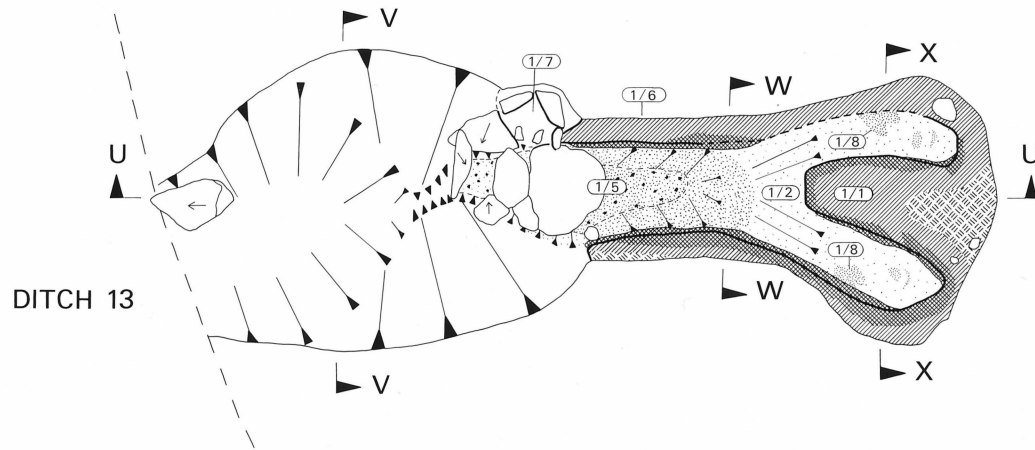

DITCH 13

U T

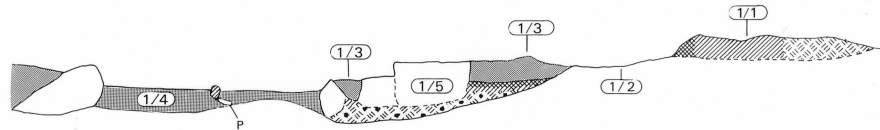

Sections U-X at same datum

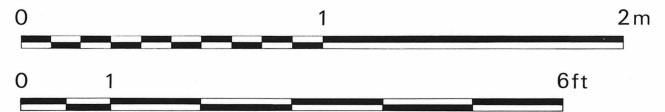
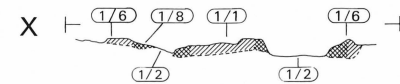
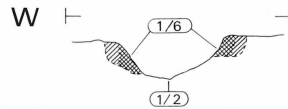
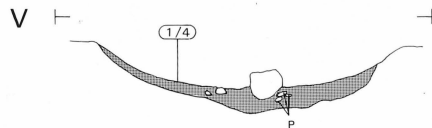

Cherrytree Farm 1983

KILNS 2 & 3

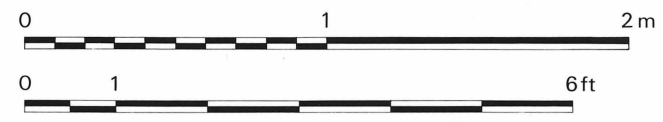
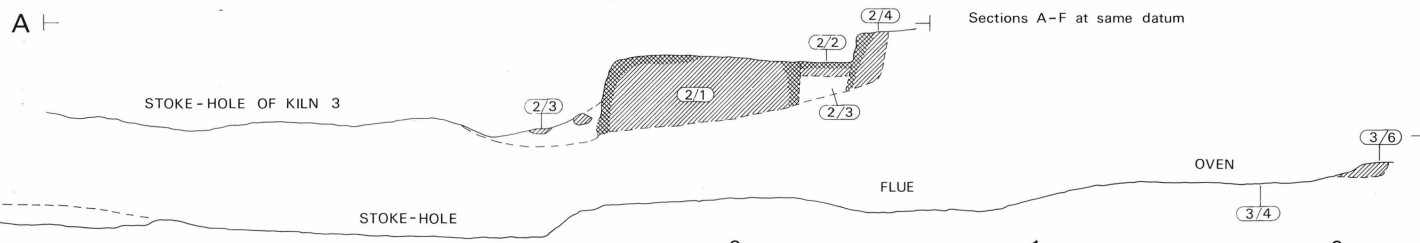
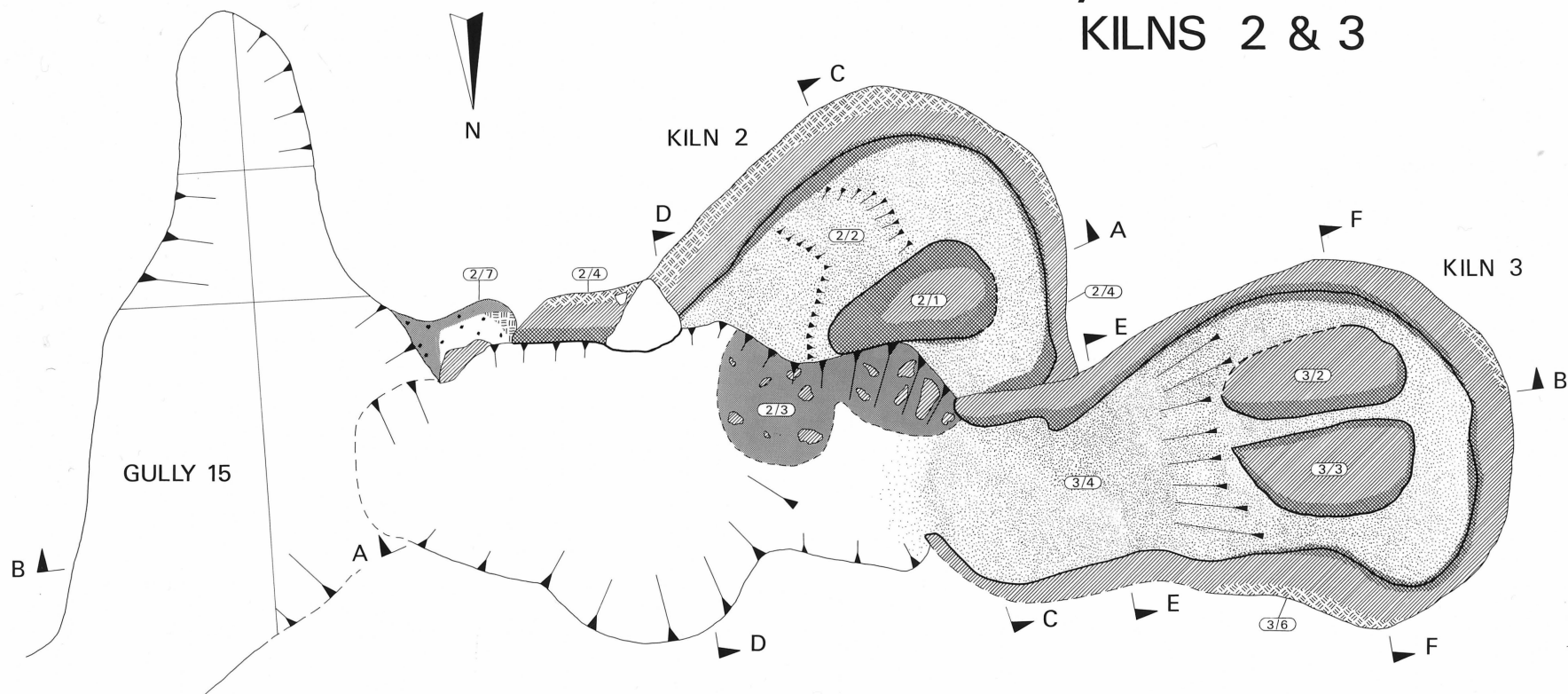

MANCETTER 1983
CHERRY TREE FARM

KILNS 2-4
AFTER EXCAVATION

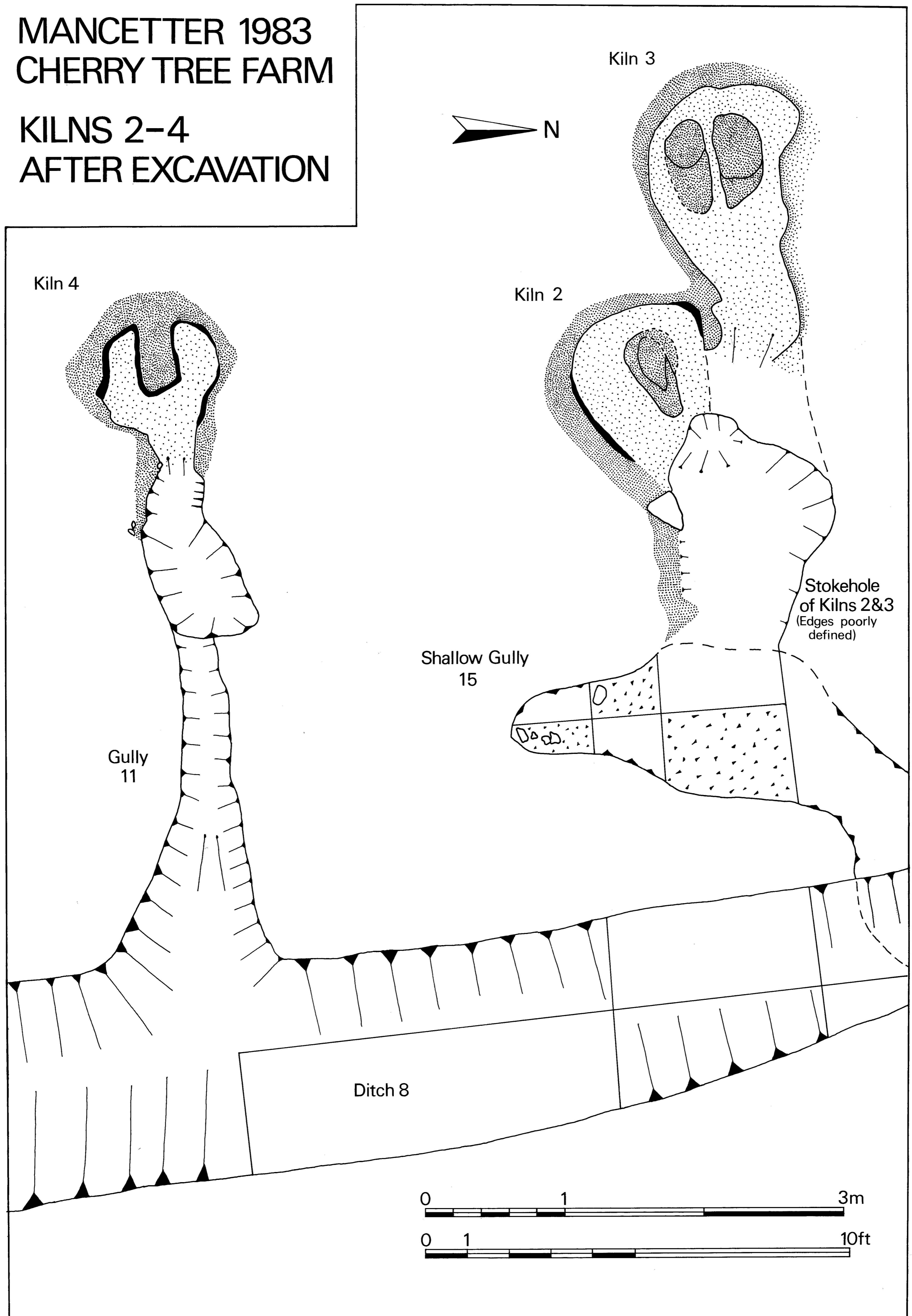

Reduce to 106 mm

Cherrytree Farm 1983

KILN 4

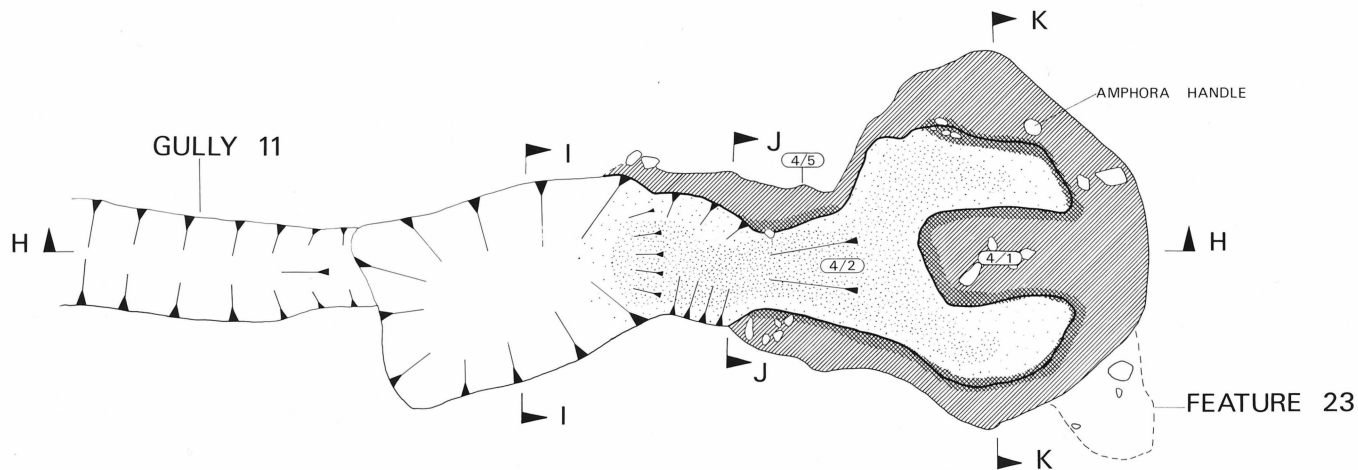

H ————— Sections H-K at same datum

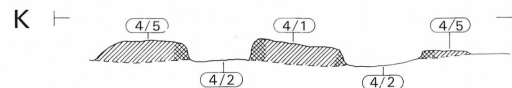
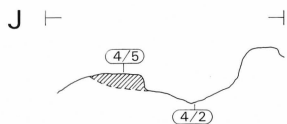
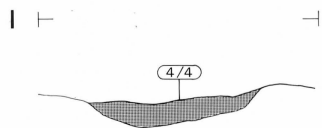
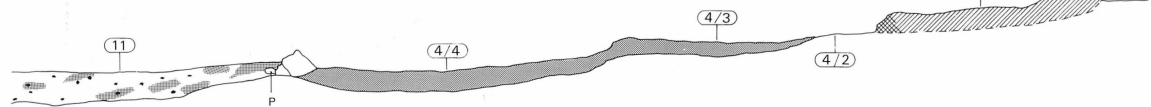

1-10
1-11
1-12
1-13
1-14
1-15
1-16
1-17
1-18
1-19
1-20
1-21
1-22
1-23
1-24
1-25
1-26
1-27
1-28
1-29
1-30
1-31
1-32
1-33
1-34
1-35
1-36
1-37
1-38
1-39
1-40
1-41
1-42
1-43
1-44
1-45
1-46
1-47
1-48
1-49
1-50
1-51
1-52
1-53
1-54
1-55
1-56
1-57
1-58
1-59
1-60
1-61
1-62
1-63
1-64
1-65
1-66
1-67
1-68
1-69
1-70
1-71
1-72
1-73
1-74
1-75
1-76
1-77
1-78
1-79
1-80
1-81
1-82
1-83
1-84
1-85
1-86
1-87
1-88
1-89
1-90
1-91
1-92
1-93
1-94
1-95
1-96
1-97
1-98
1-99
1-100

KEY FOR KILNS 105, 108 & 113

FIRED CLAY		KILN FLOOR (PLAN)	
	White		Red
	Red		Yellowish Red
	Reddish Yellow		Reddish Yellow
	Olive Brown		Olive Brown
	Blue-grey		Blue-grey

Cherrytree Farm 1983

KILN 105

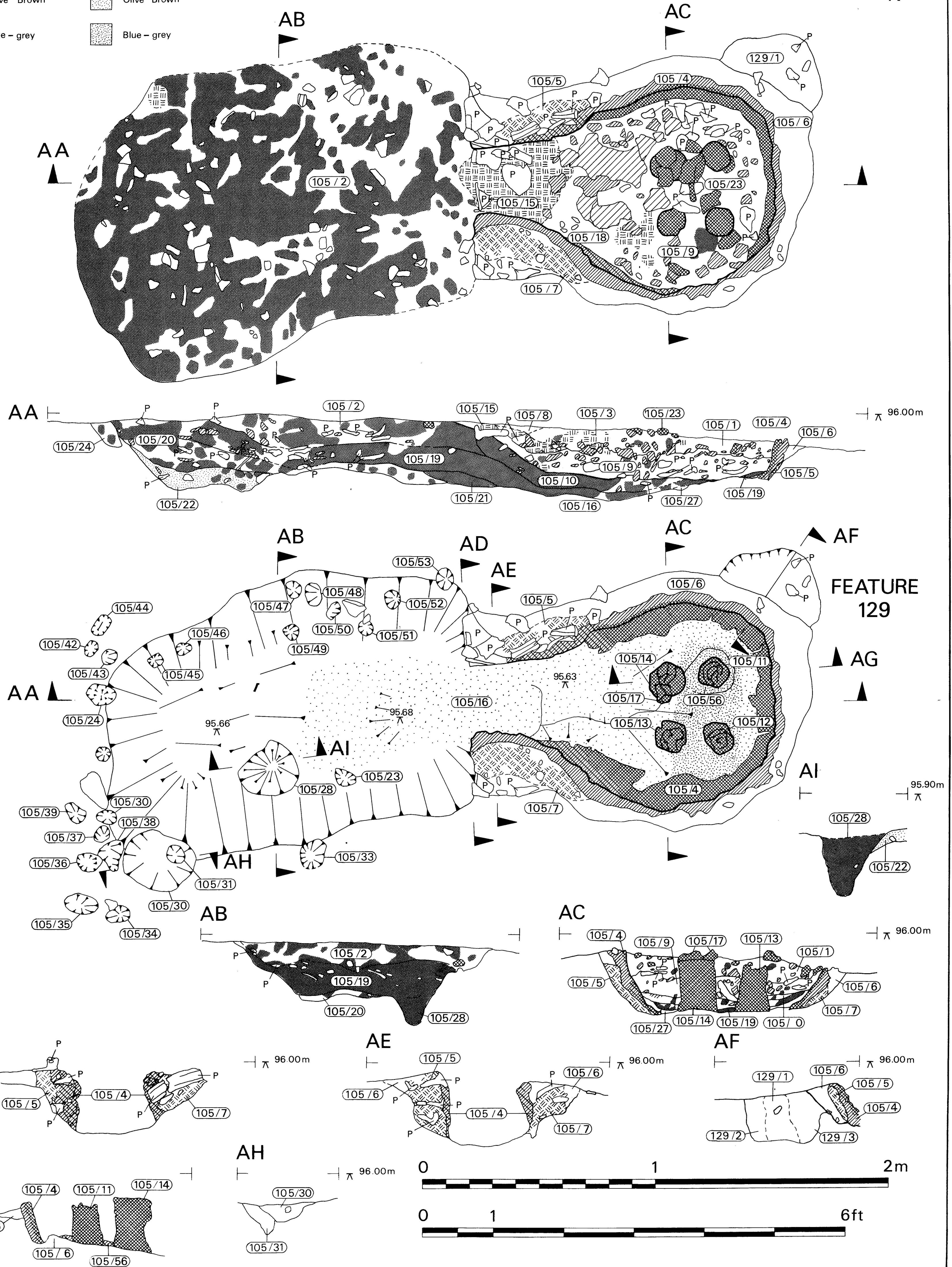
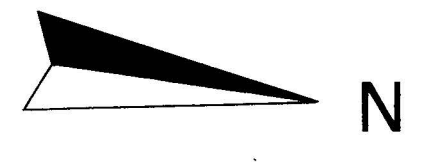

Cherrytree Farm 1983

KILN 108

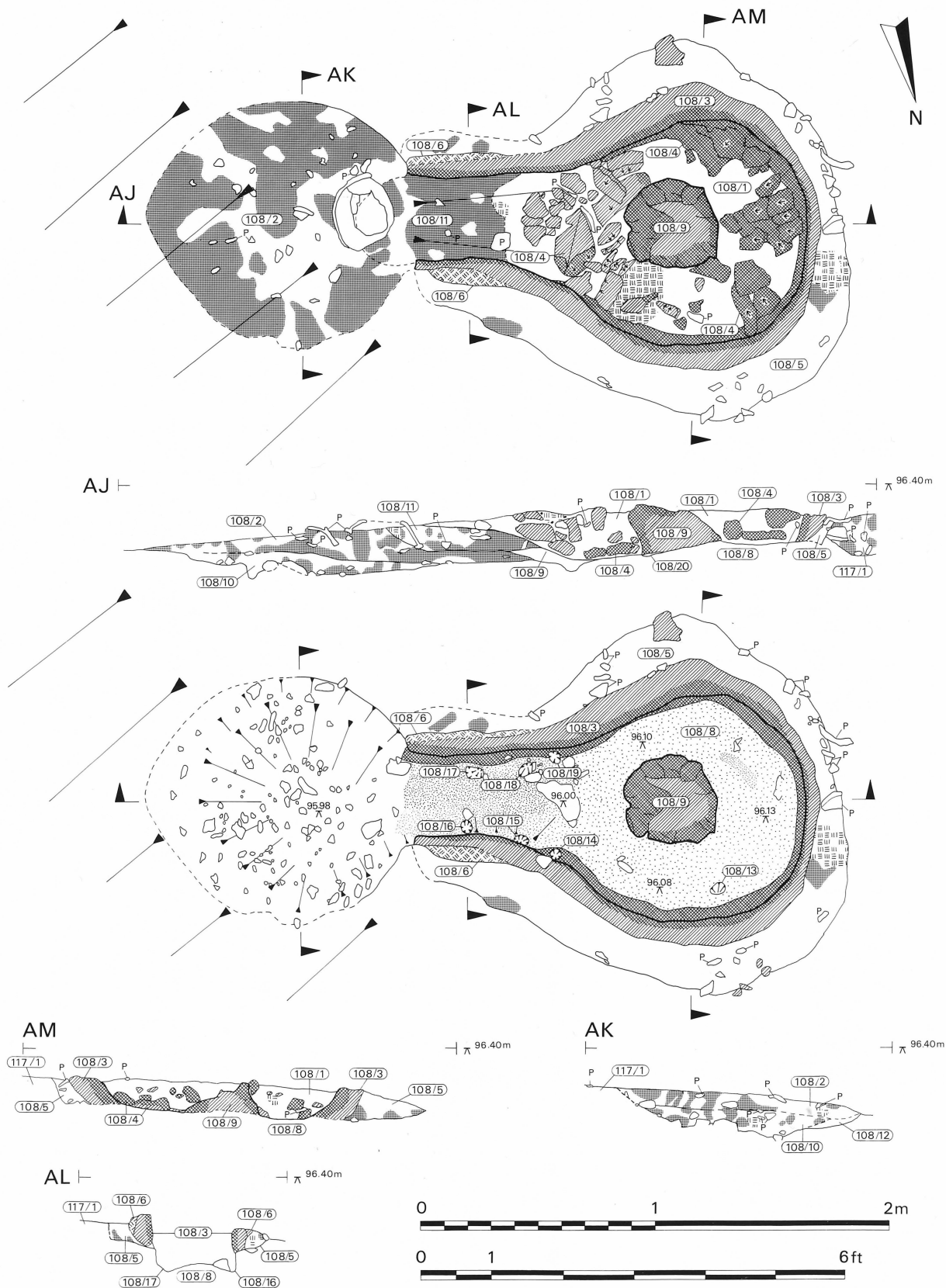

Cherrytree Farm 1983

KILN 113

