

# ‘EVERY MAN TO HIS TRADE’<sup>1</sup>: THE TUDOR BRASS BUCKLES AND OTHER FINDS FROM TRUMP STREET IN THE CITY OF LONDON

Geoff Egan and Bruce Watson

With contributions by Tony Dyson, Nigel Jeffries, Ivor Noël Hume and Harriet White

## SUMMARY

The 1956 investigation of 3–4 Trump Street in the City of London by Ivor Noël Hume revealed amongst other discoveries two medieval wells. One of these wells, which was backfilled during the 17th century, contained a variety of finds including ceramics, iron cramps, fragments of a wooden bucket and glass alembics or retorts. Excavation of the basal portion of the second well revealed a significant 16th-century finds assemblage. The wooden objects recovered included bowls, dishes and plates, two spinning tops, a sandglass endpiece and a fragment of a cask headpiece. Glassware present consisted of drinking vessels and urinals. The metalwork included a pewter spoon, two lead objects and 136 pieces of brass sheeting and wire, which were components for dress accessory buckles with bow shaped frames. These items comprise: 43 relating to buckle frames plus one complete buckle with iron pin; 44 to buckle plates; 23 to strapends (with a further 9 which might have been for either of the latter two categories); 7 decorated shapes of uncertain function and 5 examples of material relating to mounts. The remaining material consists of miscellaneous offcuts, trimmings and waste, plus one fragment of wire. These components were all discarded at various stages of manufacture, which allows the process to be studied and reconstructed. The mass production of cheap sheet metal buckles during the early 16th-century was an important technical development, as these buckles could be manufactured almost anywhere with only a few tools and a supply of sheet metal and wire. Previously

this material has been described as copper alloy, but metallurgical examination has now determined that the major elements present were copper and zinc so the material should be described as brass.

## THE CIRCUMSTANCES OF FIELDWORK IN 1956

Ivor Noël Hume

Rescue archaeology within the square mile of the City had a somewhat chequered history extending back to the mid-19th century. Knowledgeable amateur antiquaries like Charles Roach Smith and John E Price visited building sites and obtained artefacts from the workmen, many of which found their way into the Corporation of London’s Guildhall Museum. However, as Price made clear in his 1873 report on finds from the National Safe Deposit premises, his interest focused almost exclusively on the Roman period (Price 1873). That understandable bias persisted when the late Adrian Oswald joined the Guildhall Museum staff in 1939 and became responsible for archaeological salvage. His boss, museum clerk Quintin Waddington, had previously shouldered that responsibility, touring the building sites with a fish basket on his arm to transport the loot. In the 1920s the recovery of museum quality objects became a contest between the Guildhall Museum and the London

Museum's 'Inspector of Excavations' G F 'Stony Jack' Lawrence who, doubling as a dealer, was able to pay relatively well for whatever was offered to him by the workmen. Waddington, on the other hand, was known to the labourers as 'Old Tup'ny', whose lack of an acquisitions budget usually made him the loser. Interestingly, such purchases were illegal as all antiquities remained the property of the landowners. For obvious reasons, between 1939 and 1946 little or nothing was accomplished. However, when Oswald returned, concern was already being voiced for the future of the City's heritage buried under bomb-created rubble that extended across 50 acres (20.2ha) scattered from Ludgate to the Tower.

In 1946 the Society of Antiquaries of London, having sponsored a short season of trial excavation, took the initiative by establishing the Roman and Mediaeval London Excavation Council (RMLEC) under the leadership of Professor W F Grimes, and in the following year began exploratory excavations that were to continue until 1972 (Shepherd 1998). Those excavations were of the highest professional standard, and several major discoveries resulted, notably the temple of Mithras on Walbrook and the Roman fort at Cripplegate. For the most part, however, the RMLEC trenching was akin to peeping through a letterbox and trying to see the whole house. Chosen locations were dictated in large measure by the availability of already rubble-cleared basements and by the co-operation of the ground landlords.

The unwashed and unstudied artefacts from the Grimes excavations were placed in the care of Adrian Oswald and the Guildhall Museum. Having no one to transport, wash or catalogue the vast quantities of potsherds being unearthed, nor any conservation laboratory wherein to treat metal and organic objects, Oswald recruited a lone volunteer to set up a conservation lab in a Guildhall attic.

The first major post-War building project to require the Guildhall Museum's salvaging attention was not in the City but across the river in Southwark at the site of the new Bankside Power Station (now Tate Modern). That large site's history began in the 15th century but burgeoned in the 17th and 18th centuries when it became home to delftware and stoneware manufacturing as well as glass-

making, all of which Oswald found more interesting than the material labours described as 'more of the old Roman'. I worked beside Oswald on that project without either of us being aware that we were pioneering in the discipline that years later would be defined as post-medieval archaeology – and elsewhere around the world as historical archaeology (Noël Hume 1969a).

In the late autumn of 1949 I evolved from Oswald's unpaid volunteer to pittance-paid assistant. Barely a week later he became ill and left the museum. Thus by default I became the City of London's salvage archaeologist and continued in that role for the next six years. Although I was able to assemble a small, stalwart and dedicated cadre of weekend volunteers, the working week was generally a lone duty performed with few tools and no transportation. Consequently, I elected to focus much of my attention on discrete features whose stratigraphy was intact and relatively easily recorded, *eg* cellars, wells and refuse pits. Their contents provided artefact-rich time capsules able to be quickly excavated by one man amid the chaos of a building site. The Trump Street well (ER No. 319) was one of them.

At a depth of 9ft 2ins (2.78m) below the pre-War basement, the chalk-walled cylinder rested on a roughly shaped oak ring which provided a flat surface on which to seat the first course of blocks. I was to learn that in Virginia (and elsewhere) where shafts were dug through clay the process was reversed. A carefully constructed wooden ring was set in a hole three or four feet deep with the bottom brick courses laid on top of it. The digger working within the circle then undercut and wedged the ring. When further brick courses were added, and the wedges removed, their weight caused the wall to slide down thereby protecting the man working within the shaft. In Virginia such wells could be safely dug to a depth of forty and more feet. From the early 17th through the 18th century, well bricks (known as 'compass' bricks) were tapered to lock in place as the shaft eased down. The Trump Street well, however, being built from the bottom up, required that the chalk blocks be dressed only on their interior face.

By the accident of my career-dictated progress from London to Virginia, the photographed sectional view of the Trump Street

shaft enjoys the questionable distinction of being featured in the introduction to my booklet *The Wells of Williamsburg*, which remains in print nearly 40 years later (Noël Hume 1969b).

## INTRODUCTION

The site of 3–4 Trump Street in the City of London, EC2 (NGR 532461 181233) was investigated in 1955 by the late Professor Grimes as part of his 1946–72 campaign of fieldwork on war damaged sites (Fig 1).<sup>2</sup> He opened up three trenches within the existing basements close to the Lawrence Lane frontage (Grimes 1968, 135–7; Shepherd 1998, 68). The majority of the deposits excavated were of early Roman date and the only post-Roman feature relevant to this article was a chalk-lined medieval cesspit which was partly exposed at the southern end of Trench B along the Lawrence Lane frontage (Fig 2, cesspit 1). All pottery from this feature was residual Roman material (date range AD 140–250).

When the site was redeveloped during 1956

a watching-brief was carried out by Ivor Noël Hume, Guildhall Museum archaeologist.<sup>3</sup> His fieldwork revealed a number of significant discoveries, which were never fully analysed or published. During 2000–1, the site was redeveloped again as part of a larger scheme; this has served as the impetus to publish the earlier fieldwork (Blair & Watson 2005).

Complete lists of the post-Roman pottery codes cited, including details and date ranges, are available from the London Archaeological Archive and Research Centre (LAARC) as part of the research archive and are also posted on: [www.museumoflondon.org.uk/.../post92mol\\_post\\_roman\\_fab\\_form.pdf](http://www.museumoflondon.org.uk/.../post92mol_post_roman_fab_form.pdf) (accessed 2012).

## THE RESULTS OF THE 1956 WATCHING-BRIEF

The 1956 watching-brief within the centre of the site revealed a well preserved, square arrangement of four edge laid, jointed planks, forming one tier of a box frame Roman well. Associated finds consisted of three buff-white ware flagons and other pottery of 2nd-

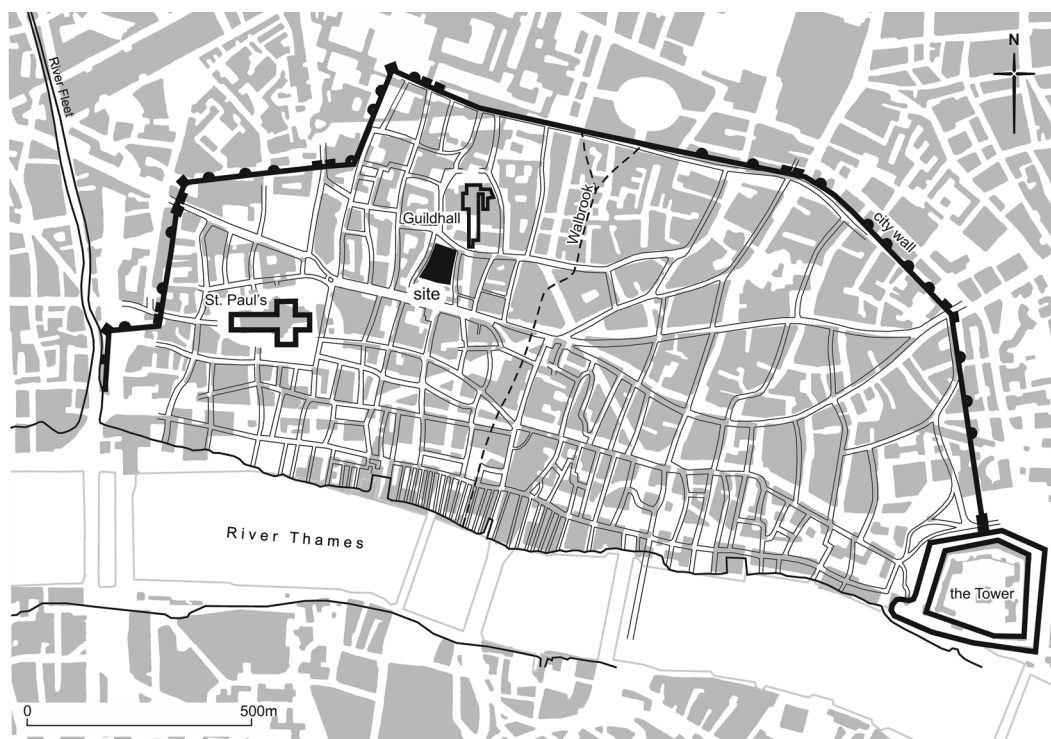
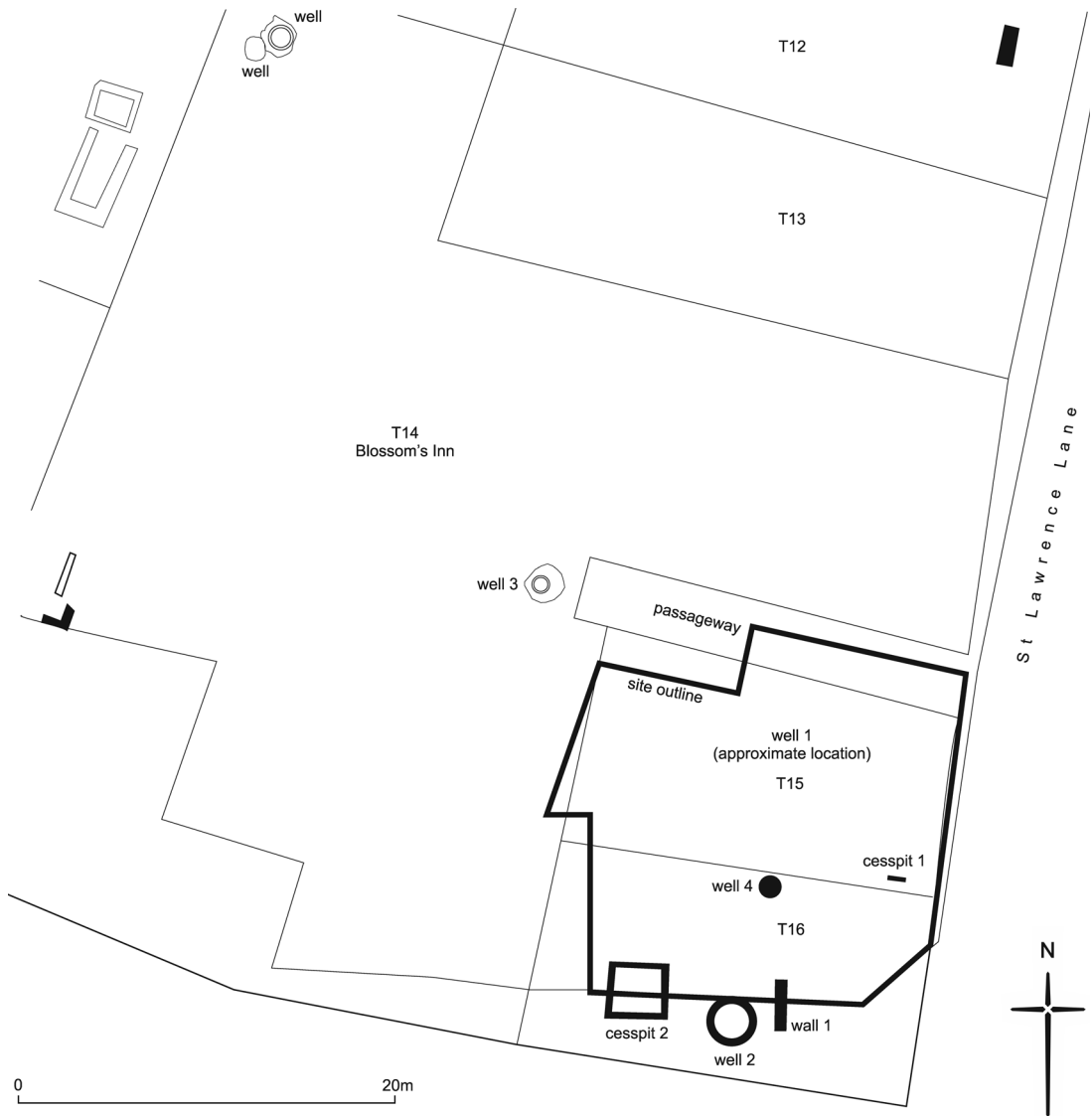

Fig 1. Plan showing the location of the site of Blossom's Inn and 3–4 Trump Street



*Fig 2. The area of Blossom's Inn and 3–4 Trump Street, showing the layout of the medieval tenements, plus the location of various features mentioned in the text: cesspit 1, cesspit 2, wall 1, and wells 1–4*

century date. The Roman deposits recorded during the 1955–56 work will be reappraised as part of the post-excavation of the 2000–1 fieldwork (Watson *et al* in prep).

### Well 1

In the centre of the site (Fig 2, well 1) a medieval, circular, mortared chalk rubble lined well, founded on a circular arrangement of timbers, was uncovered.<sup>4</sup>

### The finds from well 1

*Nigel Jeffries and Bruce Watson*

Excavation of the basal sands and silts inside the well below the water-table revealed a wide variety of materials some of which were undoubtedly lost or discarded while the well was in use, including at the base of the well the remains of a small wooden stave-built bucket, represented by two fragments of its circular base and a number of short staves.

The presence of a loop on one of the staves for attaching a handle suggests that this vessel was actually lost while the well was in use.<sup>5</sup> Two iron hoops found in the well were probably the bindings from this bucket. A similar 17th-century (oak) stave-built bucket or tub (285mm high) with a circular plank base (diameter c.600mm) and traces of willow bindings was recovered from East Gate Tower, Gloucester (Morris 1983, 208).

Discarded between c.1600 and 1700, the eight ceramic vessels found suggest a preference for Essex and Rhenish made drinking and serving vessels. The Rhenish stonewares comprise the lower portion of a Westerwald-type stoneware biconic jug (for close parallels cf Hurst *et al* 1986, fig 107 nos 337–8, 222), and the profile of a Frechen stoneware drinking jug. Completing the ceramic drinking vessels are the largely reconstructable Essex made, fine redware goblet and rounded cup. In addition there are two Surrey-Hampshire border whitewares with yellow-glaze, deep dishes used either in kitchen and dining areas for mixing and preparing foods or placed on the table for serving. The remaining utilitarian ceramics are two Midland purple stoneware butter pots or storage jars for food storage and dairying.<sup>6</sup>

Metal finds included two iron cramps (joiner's dogs); an 18th-century iron key; a bone handled iron knife; three spurs (rowels missing); a rectangular iron bar, possibly part of a handle; and a copper-alloy socket type candlestick. The only surviving wooden object is a half turned block with a central perforation, possibly a reel.<sup>7</sup> Clay tobacco pipes included a bowl heel stamped with a rosette design dating to 1610–40.<sup>8</sup> The finds assemblage confirms that this medieval well served a secondary function as a rubbish pit during the 17th century. The iron key is interpreted as intrusive.

Two long cylindrical glass fragments are interpreted as either alembic or retort spouts, which are probably of 16th- or 17th-century date.<sup>9</sup> An alembic or glass still consisted of an upright glass flask (cucurbit) placed above the heat source, over which a second inverted, convex-dome-shaped vessel (alembic) with a long spout was placed to create an airtight seal. At the end of the spout was placed a glass flask or receiving vessel (Moorhouse 1972, fig 25). A Tudor

retort or distillation flask consisted of a circular glass vessel with a long curved spout into which substances to be distilled were poured. A source of heat was then applied to the base of the vessel causing the contents to vaporise and rise into the spout, which would be connected to a condenser. An example of this type of single still is illustrated in the painting 'Alchemical Laboratory' by the studio of Francesco I de' Medici (1570) (Singer *et al* 1957, pl 28). In 1956 a group of 16th-century ceramic distillation vessels (shallow bowls and bottle shaped vessels) and crucibles was found nearby at 2–12 Gresham Street (Moorhouse 1972, 119, fig 33).<sup>10</sup> Evidence of 15th-century ceramic distillation vessels, including a brazier and cucurbit, was recently found at Baltic House in the City of London. It is thought that the Baltic House vessels were used for the distillation of nitric acid required for the parting and assaying of precious metals (Pearce 2002).

The most likely use for these alembics or retorts was small scale distillation for the production of medicinal herbal remedies and alcoholic liqueurs such as 'spirit of wine' or the distillation of essential oils from flowers and fruit such as rose oil (Tyson 2000, 168–70). This process was probably undertaken by apothecaries, who were then responsible for the manufacture and sale of drugs and medicines in London. Thanks to the labours of botanists and the importation of new drugs the apothecary's trade boomed during the 16th century. However, if Shakespeare and other contemporary writers are to be believed, apothecaries were perceived as quacks selling dubious material (Stow 1971, ii, 329–30).<sup>11</sup> According to John Stow (writing in 1603), Bucklersbury was the centre for apothecary shops in the City of London (Stow 1971, ii, 329–30). The professional status of apothecaries was clearly rising as in 1607 they were recognised as a special body within the Grocer's Company and in 1617 were organised as 'the Master, Wardens, and Society of the Art and Mystery of the Apothecaries of the City of London' (Porter 1997, 194). The evidence of distillation vessels together with the considerable number of urinals suggests that a number of doctors or apothecaries were residing within the locality of Lawrence Lane and Milk Street during the medieval and Tudor periods.

## Well 2 and other discoveries

Along the Trump Street frontage the excavation of a new linear mass foundation trench revealed a complete sequence of Roman deposits, plus three medieval features. First, at the western end of the trench, there was a large rectangular cesspit lined with mortared chalk and ragstone rubble masonry some 0.38m wide; its internal dimensions were 1.75m by 2.05m and it extended 2.0m below the existing basement (Fig 2, cesspit 2). The interior of the pit had apparently been 'cleared out in recent times', but on stylistic grounds its construction is dated to *c.*1200–1600.<sup>12</sup> Several of the nearby medieval stone-lined cesspits at 1–6 Milk Street were still in use during the post-medieval period (Schofield *et al* 1990, 218–19). Secondly, the central portion of the southern edge of the new foundation trench bisected a well (Fig 2, well 2; Fig 3). The circular well was lined with



Fig 3. Photo of well 2 fully excavated down to the wooden ring, the ranging pole has intervals in feet (Source: GM 20 archive Ivor Noël Hume)

coursed mortared chalk rubble masonry, 0.6m thick; it had an internal diameter of 0.86m. Within the lower portions of the well lining were four small holes or recesses arranged in pairs at intervals of about 0.75m, interpreted as 'footholes'.<sup>13</sup> The base of the masonry lining, recorded at a depth of 2.78m below existing basement floor level, was founded on a circular arrangement of timbers (7.5cm thick). The sequence of well construction is described in the section on the circumstances of the fieldwork, above. The lower 0.7m of wet, black organic silts contained a multitude of finds which are described below.<sup>14</sup> The upper portion of the well was infilled with 'loose material', consisting mainly of broken roof tiles, probably demolition material representing systematic infilling; the only recorded find from this deposit was a glass bottle.<sup>15</sup>

To the east of well 2, a 3m length of trench-built mortared chalk rubble cellar wall foundation, 0.66m wide, was found (Fig 2, wall 1). This wall is dated on stylistic grounds to *c.*1200–1600. It may have been part of the rear wall of one of the properties lining the street frontage.

Workmen digging out a new pier base in the north-west corner of the site discovered a concentration of post-medieval finds, implying the existence of one or more (unrecorded) features such as disused wells, infilled cellars or cesspits (finds described below as 'other discoveries'). During the 2000–1 fieldwork no comparable medieval or post-medieval stone- or brick-lined features were found here, but their absence was probably due to the damage caused by the previous development. However, the basal portion of a circular, stone-lined medieval well was found within the Blossom's Inn property further west; it remained in use until the 18th century (Fig 2, well 3).

## Finds from other discoveries

*Nigel Jeffries and Bruce Watson*

The remaining ceramics are variably dated, indicating that this material was derived from different sources. The latest material, consisting of a complete 17th-century Frechen (Bellarmine) stoneware drinking jug and a fragment of blue and white Chinese porcelain, can be considered contemporary.

Earlier or residual finds include a Dutch slip-decorated cauldron, a Siegburg stoneware jug (1300–1500) and sherds of Mill Green ware (1270–1350), all medieval in date. There was also a fragment of a samian bowl (Dr 27). Metalwork included the lower stem and base of a copper-alloy candle holder (incurved type) [21123] (Museum of London accession number); and a trefoil ornamented, copper-alloy, double loop, rectangular belt buckle, complete with pin and attached leather waist belt [21127].<sup>16</sup>

One unusual type of vessel was a 16th-century Dutch, slip-decorated redware, bulbous tripod cauldron, decorated with yellow slip arcs or gadroons.<sup>17</sup> Its shape is considered to be derived from that of contemporary metal vessels.

## THE 2000–1 FIELDWORK AND DOCUMENTARY RESEARCH

*Tony Dyson and Bruce Watson*

Much of the archaeological deposits within the footprint of the 1956 development had been disturbed or truncated, but there were still some areas of good stratigraphic survival. No trace of the two stone-lined wells survived, but part of the northern wall of cesspit 1 and a short northern continuation of wall 1 were located during the 2000–1 fieldwork. Other relevant medieval (1200–1500) discoveries during the recent fieldwork include two tiny fragments of chalk and ragstone cellar wall foundation; three clusters of piles interpreted as foundations for truncated cellar walls; and a barrel lined well, which was infilled with domestic rubbish during 1290–1400. This well was not recorded in 1956 (Fig 2, well 4).<sup>18</sup>

During the medieval period 3–4 Trump Street lay within the parish of St Lawrence Jewry and documentary research has established the pattern of the contemporary tenements. Most of the site was occupied by two tenements which for research purposes are numbered 15 and 16 (Fig 2).<sup>19</sup> These two tenements fronted on to St Lawrence Lane and lay to the south of a passageway or alley (Trump Street was only established after the Great Fire of 1666). In 1336 it is documented that Tenement 15 was occupied by two shops with solars above. While Tenement 16 in 1346 was described as the 'brewhouse tenement'

then occupied by three shops with solars above. The reference to brewing suggests that this tenement possessed a good water supply, hence the existence of two wells (Fig 2, wells 2 and 4). In a deed of 1 March 1401 these two tenements were referred to as the eastern abutment of the garden of Blossom's Inn. This neighbouring property (Tenement 14) was first documented in 1374, and is believed to be named after the family who formerly resided here. By the 15th century this property had become an inn or hostelry, which continued to trade until 1855. The documentary history of Tenement 16 (the southern part of the site) has been researched up to 1451, but there is no available evidence for the period 1451–1668 (Dyson 2001). This absence is probably due to this particular tenement passing through a succession of modest 'private' owners or occupiers, whose records do not survive. John Stow in 1603 described St Lawrence Lane as possessing 'many fayre houses' and 'one large Inn for receipt of traelers, called Blossoms Inne' (Stow 1971, i, 270–1).

## THE FINDS FROM WELL 2

### The context of the finds from well 2

The distribution of excavated medieval wells within this area of the City of London implies that they were shared amenities often situated within backyards or courtyards. Clearly while these wells were in use they were used occasionally for the disposal of a variety of unwanted objects. Hence the wide variety of well-preserved objects recovered from the basal fills of these structures. However, some objects recovered from the basal fills of these wells, such as the possible stave-built bucket from well 1 (see above), probably represent accidental losses during the extraction of water. Disused wells were sometimes used to dispose of cess and domestic rubbish (*eg* well 1 during the 17th century) or were simply infilled on a systemic basis (as apparently happened to well 2). Soon after the Great Fire of 1666 (which destroyed all the buildings on site on either 4 or 5 September), some redundant medieval wells were simply infilled with demolition or destruction debris (Blair & Watson in prep). For instance, one of the medieval wells along the Milk Street frontage (Tenement 5) went

out of use c.1660–80, when it was backfilled with destruction debris from the Great Fire, including door furniture and various domestic items (Watson *et al* in prep).

No pottery or clay tobacco pipes are recorded as being retrieved from this well. For a complete catalogue of this material see Appendix 1.

### The animal bones and bone objects

The surviving animal bones consist of a chicken skull, two fragments of chicken sternum and a rabbit mandible.<sup>20</sup> There was also part of a bone knife handle.

### Jet objects

There is a jet rosary bead; it is slightly oval in shape with a centrally drilled hole. The bead is likely to be of pre-1558 date. An Italian visitor to England in 1500 noted that some women at the daily Mass carried 'long rosaries in their hands' (Brigden 1989, 15). Rosary beads were probably quite common personal possessions in pre-Reformation London, yet relatively few examples are known from archaeological investigations. A number of medieval turned wooden rosary beads are known from Worship Street, London (Foister 2003, 343, fig 222a).<sup>21</sup>

### The wooden objects

A wide variety of wooden objects was recovered, including a thick peg or bung and a peg or stopper. A similar bung was found sealing the neck of a leather costrel or wine bag recovered from the wreck of the Mary Rose (sank 1545) (Wood 2005, 488). Pegs could also have been used to seal the bung hole in casks.

There was also a semi-circular fragment of cask headpiece (Fig 4, 9). Its circumference is bevelled and along its inner edge are two dowel peg holes; the diameter of the head was 292mm. A large number of cask headpieces were recovered from the Mary Rose; one example made from a single plank had a diameter of c.300mm, and its staves were c.500mm long (Rodrigues 2005, fig 10.33). The volume of the Trump Street cask is difficult to estimate in the absence of any associated staves, but comparison with the Mary Rose casks suggests that it was probably

part of a small (holding 16.8–150 litres) or medium sized (151–250 litres) cask. The headpieces of the medium and large sized Mary Rose casks were all of composite construction, containing up to five dowelled planks (Rodrigues 2005, table 10.3, 419). The Trump Street cask probably contained beer or wine, while the Mary Rose examples contained a variety of food stuffs and other commodities (Rodrigues 2005, 416–18).

There were a number of fragments of lathe turned, circular platters (or trenchers), shallow dishes and bowls (Fig 4, 1; 2; 4).<sup>22</sup> These vessels would have been used for the preparation and serving of food. Wooden serving vessels were very common during the medieval period, but they were generally replaced by pewter vessels during the late 16th-century (Wood 2005, 478). A large number of wooden bowls, dishes and platters were recovered from the Mary Rose (Wood 2005, 478–82). The contents of a 13th-century stone-lined cesspit at 1–6 Milk Street included ash, beech and maple bowls, a turned box, a box lid, a wooden counter and a tally stick (Schofield *et al* 1990, 218). The backfills of a 13th-century rubbish pit and a 14th-century well excavated during the 2000–1 fieldwork revealed a number of wooden bowls and other vessels. Eighteen turned medieval wooden bowls and dishes are known from the Priory and Hospital of St Mary Spital, London; eleven of these vessels were made of alder (*Alnus* spp) and five of ash (*Fraxinus* spp) (Egan 1997, 203–4). Excavation of the backfill of the medieval city ditch (1340–1400) at King Edward Buildings revealed 21 turned wood (both ash and alder) vessels, including bowls, dishes and platters (Keily 2007, 88).

There was also part of a two-sided comb with coarse and fine teeth (Fig 4, 8) (the coarse teeth would be used for straightening hair, the fine ones for removing nits); an oval counter/gaming piece or box lid which was probably circular originally (Fig 4, 5); and the handle of an engraving tool (Fig 4, 7). Two lathe turned wooden objects are interpreted as spinning tops; the smaller one is plain (Fig 4, 6), but the larger one has a grooved decorated top and three shallow grooves around its sides (Fig 4, 3). Wooden tops are toys of great antiquity, but are not often found on archaeological sites because



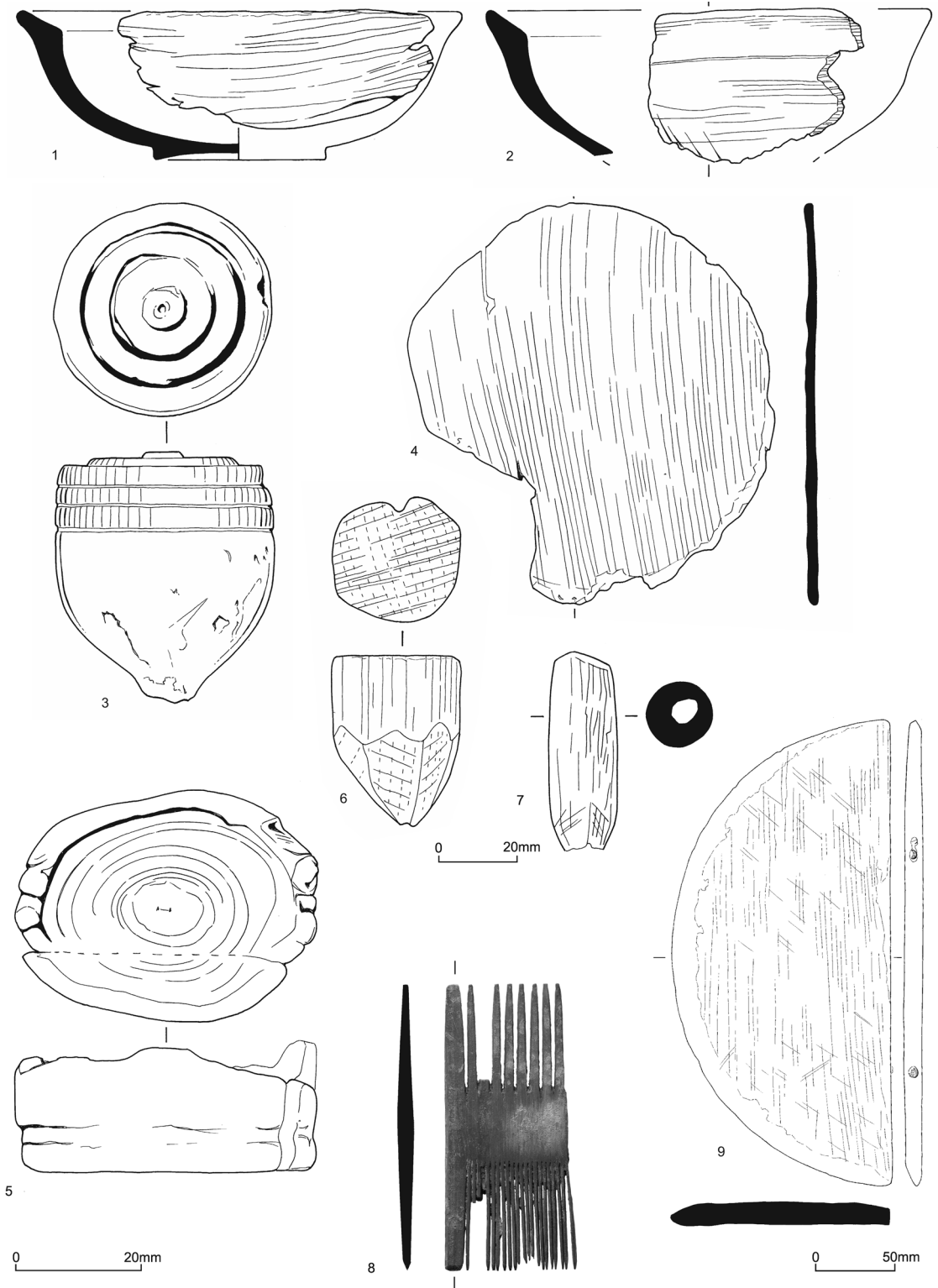

Fig 4. Selected wooden objects from well 2: 1. Bowl [21113]; 2. Bowl [21105]; 3. Decorated spinning top [21109]; 4. Platter or trencher fragment [21113]; 5. Oval box lid or gaming piece [21562]; 6. Plain spinning top [21106]; 7. Engraving tool handle [21559]; 8. Comb [21004]; 9. Cask headpiece [21137]



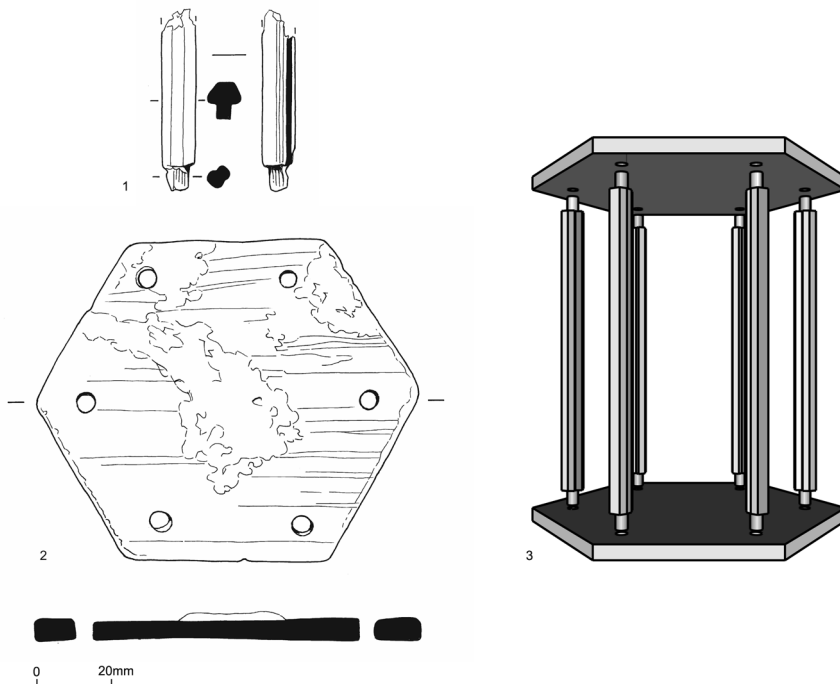

Fig 5. Sandglass fragments from well 2: end piece [2156], stave [2155] and reconstruction

of their organic nature. The excavation of a well at John Custis's House, Williamsburg, Virginia, which was infilled in *c.*1757, revealed four lathe turned wooden tops spun on iron pegs driven in the tapered ends (Noël Hume 1996, 19–31). A split ball or decorative knob might be another children's toy.

The most interesting wooden object is a complete hexagonal disc (dimensions 114 by 96mm) with six small, round perforations. It is interpreted as a sandglass endpiece (see Fig 5, 2). Another fragment is probably part of one of the staves which retained the sandglass within its case (Fig 5, 1). It has a circular dowel at one end (which presumably fitted in the base) and is T-shaped in cross-section. This base is very similar to the hexagonal type of sandglass endpieces (diameter of ends 109–110mm) found in the *Mary Rose* (Richards & Stimson 2005). Using the *Mary Rose* examples it is possible to reconstruct the sandglass frame (Fig 5, 3).

### The leather objects

There are 31 fragments of 15th-century shoes; these consist of 15 fragments of uppers, four

heel rands, four soles, one front clump, one front sole fragment with a very pointed toe, and some offcuts or trimmings.

### The glassware

There is a green glass wine bottle with a 'CM' stamp [21114], of post-1630 date. There were two bottle necks of 18th-century date [21112/22, 21112/9] (Museum of London accession number). These bottles are considered to be intrusive finds and may have been derived from the upper fill of the well.

There were eleven fragments of pale green flasks or urinals with convex bases [21112/1–7, 21] of 15th-century date (Tyson 2000, type F8, g1070–1). According to medieval medical theory, illness was seen as the imbalance of bodily humours, which were reflected in the colour and consistency of urine. So uroscopy was central to medieval diagnosis and a urinal would have been an essential possession for the rich and fashionable (Tyson 2000, 150–1). It is also possible that these flasks could have been used as receiving vessels during the distillation process (discussed earlier). Fourteen other examples of medieval flasks

or urinals have been found during other phases of archaeological fieldwork at Blossom's Inn and 1–10 Milk Street (Tyson 2000, 36–7) (Fig 1).<sup>23</sup> The 1930 fieldwork at Blossom's Inn Yard revealed four adjoining fragments, plus one separate fragment, of a green vessel glass with a crude vertical rim, of 13th- to 14th-century date. Its function is uncertain, but it might have been used for some industrial purpose such as distillation (Tyson 2000, 178, fig 36 g1229).<sup>24</sup>

There were also seven fragments of 16th-century glass drinking vessels [21112/8,10–16], including the complete base (diameter 58mm) of a cylindrical beaker with a solid applied base ring decorated with a rigaree pattern [21112/16], which confirms it is of either 16th- or early 17th-century date (Willmott 2002, 36–7). The presence of sev-

eral fragments of pinched prunts suggests that this vessel might have been a prunted barrel beaker (Willmott 2002, 42–3). The presence of several other elaborate drinking vessels is indicated by a sherd with a pinched trail decoration and a many lobbed prunt [21112/10].

## THE METALWORK

There was a copper-alloy pin, a spherical lead object, possibly a weight, covered with hammer marks on which the brass sheeting may have been rested when being stamped or otherwise manipulated, and an oval lead disc covered with hammer marks (Fig 6, 2). Both these objects may be connected with the manufacture of either sheet brass or copper-alloy objects. The oval disk might

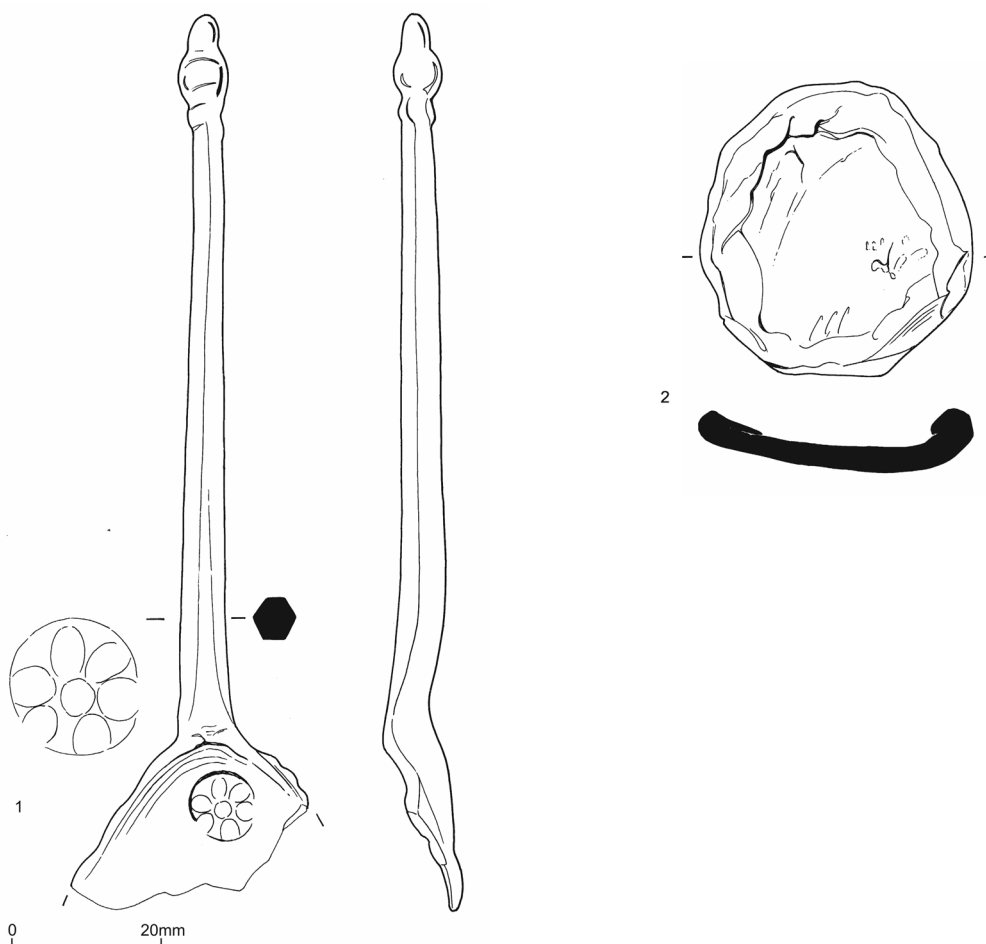

Fig 6. Pewter spoon [21116] and hammered oval lead disc object [21117] from well 2

have served as a stamping cushion and the spherical object might have been used to help flatten or shape sheet metal (discussed later). There was also a 16th-century pewter spoon with part of the bowl missing; it has a hexagonal faceted stem and acorn decorated terminal (Fig 6, 1). In the bowl there is a stamped maker's mark (a six-petalled flower). This spoon is very similar to some of the examples recovered from the Mary Rose (Weinstein 2005, 449).

## THE SHEET BRASS METALWORKING INDUSTRY

### Introduction

By 1500 copper-alloy or brass buckles for use as dress accessories were being ingeniously produced by folding sheet metal. This new technique eliminated the need for mould-making and casting in foundries. Importantly, this change in technology meant that the manufacture of these buckles need not be carried out in a workshop. Instead all that was needed were some formers, hammers, shears, a pair of pliers (for folding metal) and a supply of sheet metal and wire. These buckles and strapends were used for fastening both men's and women's clothes or waist belts (girdles). Buckles of different designs to the Trump Street examples were used in animal harness, armour, spurs and shoes.

The assemblage from well 2 is numerically dominated by its most significant items, the 136 pieces of brass sheeting and wire which were used to manufacture buckles and mounts for girdles at the end of the medieval tradition (see Appendix 1 for details). These items comprise 43 relating to buckle frames, 44 to buckle plates, 23 to strapends (with a further 9 which might have been for either of the latter two categories), 5 relating to mounts, and 12 miscellaneous, *ie* not considered definitively identifiable. What is of particular importance is that the fragments show all the stages of this new manufacturing process, which allows us to reconstruct the process in detail (John Clark pers comm). The assemblage includes waste material and reject artefacts, which were discarded during manufacture. Some aspects of this assemblage have been discussed and illustrated in Egan and Forsyth (1997,

217), Goodall (1981, 67, fig 66), Margeson (1993, 25), and Murdoch (1991, fig 1.6). A selection is on display in the Museum of London Medieval Gallery (26.1) and at the Worshipful Company of Girdlers' Livery Hall (see Appendix 1 for details).

On stylistic grounds this metalwork has been dated to the late 15th or 16th century (Goodall 1981, 67; Margeson 1993, 25). However, the date of the deposition of this assemblage of metalwork cannot be precisely established from the associated finds (discussed earlier). These finds are of broadly 16th-century date, while the spoon indicates that infilling of the well probably took place during the first half of the 16th century (Fig 6, 1).

The only tool recovered is a possible stamping cushion or disc (described earlier) (Fig 6, 2). While the extensive assemblage has shown in detail how some of the folded buckles *etc* were made, finds in London and across England from the consumption end are very few indeed (discussed later), and so currently it seems that the popularity of accessories of this kind may have been limited. Perhaps with this publication more examples will be recognised and a clearer picture of their distribution produced.

The terminology used to describe the buckle components is based on that used in Egan and Pritchard (1991, fig 32, 33). The relevant components consist of the frame or loop, the bar (which attached the frame to the plate), the pin (which fitted around the bar and secured the perforated strap), and the folded plate which secured the buckle and bar to the strapend; the plate would have been secured to the strapend by rivets.

In terms of the decorative motifs referred to in the catalogue, 'beading' is used to describe either an edge or an internal linear decoration consisting of a single line of closely spaced, small, convex dots (produced by repeatedly striking with a punch). The linear rope-like decoration is described as 'cording'. Pieces with a decorative border (without indentations) are described as 'engrailed'. The edges of sheet metal which have been trimmed to make a row of semi-circular indentations are described as 'denticulated'. A variety of flower-like convex decorations are described as 'florets', the number of petals or segments present always being

cited. This term is also used to describe the domed rosette or flower-like motif present on [21111/83] (Fig 13, 2). Punch-struck decorative motifs within roundels that have penetrated through the sheeting are described as 'piercings', and those which have not are described as 'punch-struck'. The range of decorative motifs present is discussed below.

All the sheet brass metalwork from well 2 shares one generic Museum of London accession number [21111], while the individual items are identified by means of a series of numerical suffixes.

Dimensions are represented by the following abbreviations: D= diameter; L = length; W = width. All dimensions cited are in millimetres. The two opposite sides of a folded buckle plate or strapend are referred to as 'buckle side' (front) or 'strap side' (rear).

### The sheeting used

Thickness mainly varies between *c.*0.1 and *c.*0.5mm. Some smooth and even items are very well preserved while others are crumpled, or corroded right through, *eg* [21111/132]; some were holed by the stamping (see [21111/11]). A few have discrete reddish areas of purer copper mixed with the more widespread yellower ('brassy') alloy (*eg* [21111/23], compare with [21111/127]). These 'mixed' items tend to be superficially corroded.

### Simple sheet buckle frame

[21111/79] Thick sheeting; L25 x W19mm. This very simple form consisted of a simple rectangular frame with a central bar. This piece is assumed to be a buckle frame, but as it is the only example present this interpretation cannot be confirmed. Some slight adaptation may have been required before this was ready for use (Fig 7).

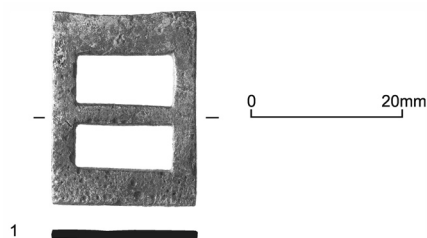

Fig 7. Rectangular sheet buckle frame [21111/79]

### Composite buckle frames

Stages of manufacture:

- 1 Strip cut to shape with shears (Fig 8, 1a).
- 2 Central area of strip folded (in most this remains U- or V-shaped in section, though in finished buckle [21111/19] it is much tighter, where it has been pressed together, presumably hammered). In [21111/55] the middle remains flat (or possibly it was re-shaped in this way), presumably providing for the wider, flat area against which the pin would rest.
- 3 Bent into biconvex shape (no items recovered from this stage, not illus).
- 4 Ends bent over (Fig 8, 4a).
- 5 Bar and pin added (no items recovered from this stage) (Fig 8, 5a).
- 6 Outer edge of frame flattened (no items recovered from this stage) (Fig 8, 6a).
- 7 Pin added.

*Sheet strips, presumably trimmings*

*Material discarded at Stage 1*

[21111/27] Thick sheeting; L61 x W2.5mm; curving strip. Probably part of a strip for frame as for [21111/22].

[21111/29] (Fig 9, 1) Thick sheeting; L97 x W4mm; uneven, tapered.

[21111/33] Thin sheeting; L81 x W2mm; slightly curving as found.

[21111/34] Thin sheeting; L96 x W*c.*1.25mm; uneven.

[21111/90] Thick sheeting; L62 x W4mm.

[21111/91] Thick sheeting; L41 x W4mm.

[21111/92] Thin sheeting; L44 x W up to *c.*3mm; uneven and tapering.

*Discarded at Stage 2*

Strips of sheeting with all but the ends folded down the length (ranging in cross-section from a narrow to a broad U) leaving flattish end tabs (the shorter ones are of relatively thin sheeting, while those 65mm long or more are relatively thick). One piece [21111/55] with its central area not folded does not readily relate to either form of the frames recovered from the assemblage; it may represent a third variety, which was not recovered in a more completed state. The frame of a buckle from elsewhere in London (private collection) looks as if it has been made from a strip in which only one side of the component strip was not folded at the

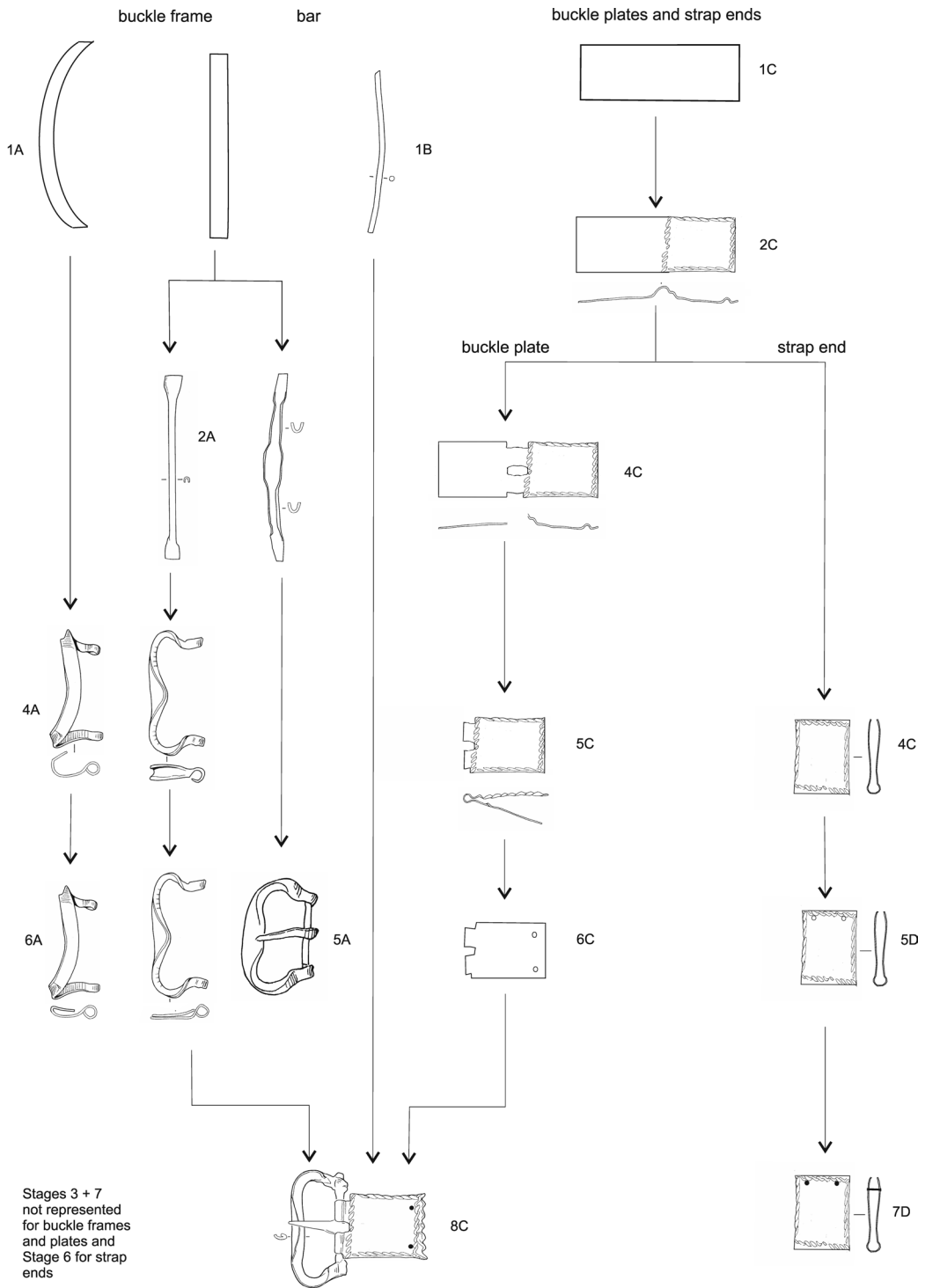

*Fig 8. Suggested sequence of manufacture of sheet buckle frames, buckle plates and strap ends*

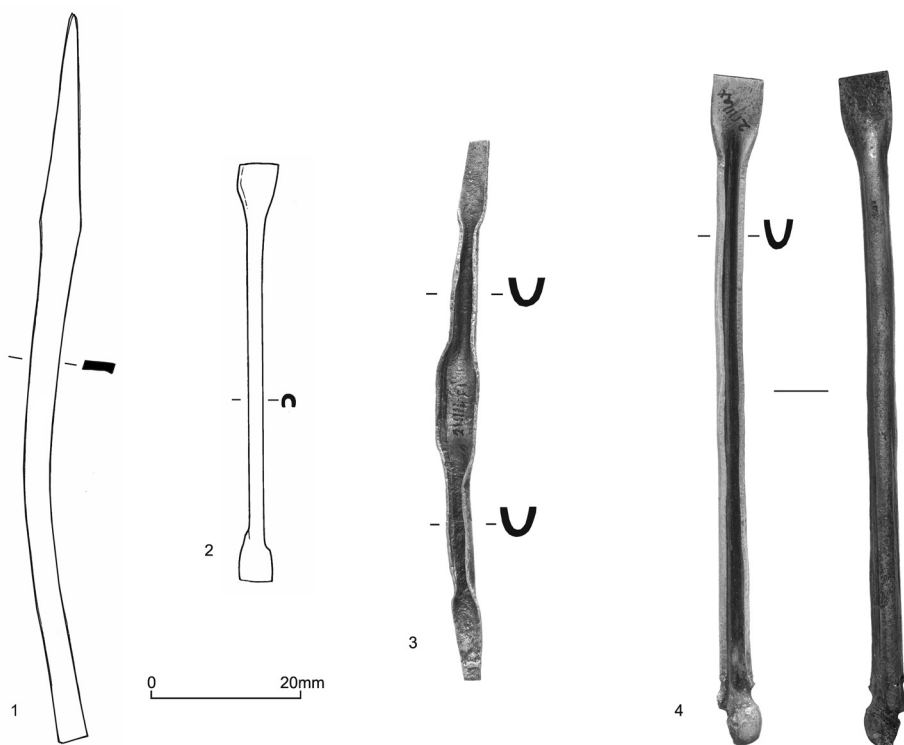

Fig 9. Sheet strips for buckle frames. 1. Cut tapered strip [21111/29]; 2. Folded strip [21111/88]; 3. Folded strip with flattened central section [21111/55]; 4. Folded strip melted at one end [21111/50]

centre (experimentation could perhaps shed further light on this point).

[21111/25] L86 x W6mm.

[21111/30] L65 x W6mm.

[21111/31] L58 x W4.5mm.

[21111/50] (Fig 9, 4) L90 x W6mm; apparently partly melted at one end.

[21111/54] L58mm x W6mm.

[21111/55] (Fig 9, 3) L81 x W4mm; widens at centre.

[21111/68] L56mm.

[21111/85] L54 x W6mm.

[21111/88] (Fig 9, 2) L55 x W4mm.

[21111/93] L68 x W4mm.

[21111/94] L52 x W2mm.

*Presumably incomplete versions of the preceding (each with one end broken off)*

[21111/24] Thick sheeting; surviving L70 x W5mm, possibly damaged.

[21111/32] Thick sheeting; surviving L51 x W6mm.

[21111/56] Thick sheeting; surviving L46 x

W5mm; probably joins [21111/84].

[21111/84] Thick sheeting; surviving L42 x W6mm; probably joins [21111/32].

[21111/95] Surviving L37 x W4mm.

[21111/96] Surviving L35 x W4mm.

[21111/97] Thick sheeting; surviving L49 x W6mm.

#### *Discarded at Stage 4*

There appear to be at least two different forms. The slightly simpler one [21111/22], which was presumably made from a curved strip folded at the ends, like [21111/88]. The other form was presumably made from straight strips folded and then bent, like [21111/57]. None of the following has been finished by being flattened (as [21111/19] has).

[21111/1] (Fig 10, 3) Thick sheeting not flattened; L46 x W18mm.

[21111/20] L54 x W21mm; bi-convex hooked ends.

[21111/21] Thin sheeting; ends distorted/broken off; 30 x 8mm (sides correspond at centre).

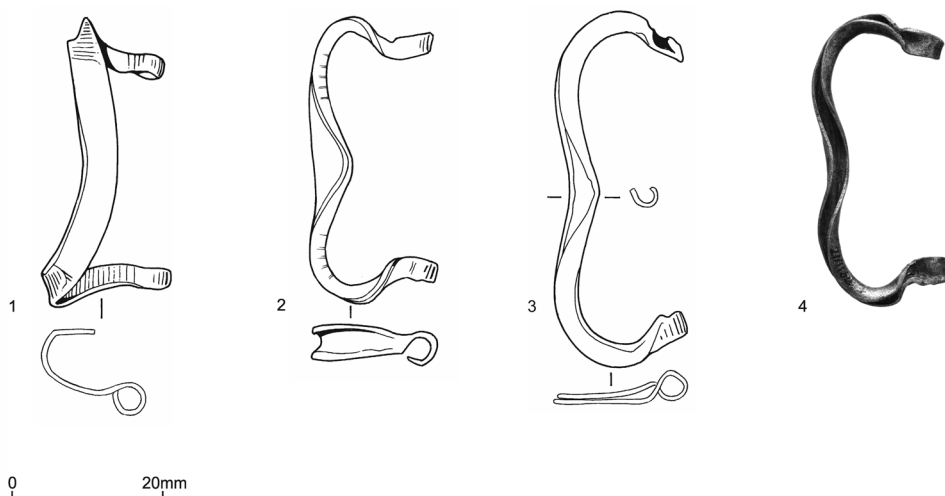

Fig 10. Bent sheet buckle frames. 1. Folded and curved buckle frame [21111/22]; 2. Folded and curved buckle frame [21111/37]; 3. Folded and curved buckle frame [21111/1]; 4. Folded and curved buckle frame [21111/57]

[21111/22] (Fig 10, 1) Thick sheeting; L37 x W17.5mm; made from curved strip with two right-angled bends (not folded lengthways).

[21111/37] (Fig 10, 2) Medium sheeting not flattened; L38 x W16mm; central overlap as in [21111/19].

[21111/46] (Fig 10, 4) Thick sheeting; L47 x W17mm; central part has overlap and is tightly folded; slight damage to outside edge.

[21111/48] L51 x W18mm.

[21111/57] Thick sheeting; L44 x W20mm; central overlap.

[21111/66] L37mm; bi-convex hooked ends.

[2111/67] L29mm; the central portion of this frame is flat; bi-convex hooked ends.

[21111/98] Thin sheeting; L38 x W13mm; (central overlap as in Fig 11, 1).

### Wire, possibly for bar(s) of frame(s)

The only brass wire recovered is the following length (which is associated with the buckles only because it is in the assemblage) (Fig 8, 1b). This could alternatively have been intended for making rivets (either for buckle plates or for strapends). An iron wire (inside edge) is present in the only complete buckle (Fig 11, 1).

[21111/87] (Fig 11, 2) Gauge *c.* 1.5mm; surviving L48mm; apparently broken off at both ends; irregularities suggest some difficulties may have been encountered in the drawing

process: there are two grooves, one slightly meandering, and small areas of probable damage with apparent tearing.

### Buckle pins

The only buckle pin in the assemblage, of iron, is on the finished buckle [21111/19]. A single example of ingeniously folded copper-alloy sheeting is known from the Thames Exchange site.<sup>25</sup>

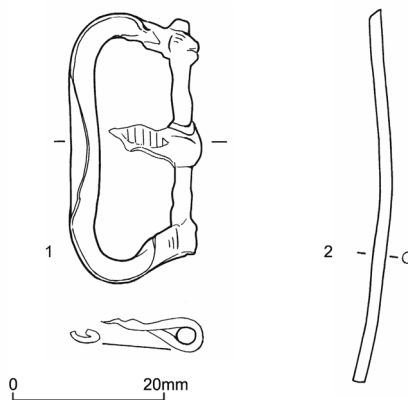

Fig 11. Buckle frame and wire. 1. Complete buckle with iron bar [21111/19]; 2. Wire, perhaps for buckle frame bar or rivets [21111/87]



### Complete composite buckle frame

The following, sole finished (*ie* usable) example from the assemblage includes two components of iron, but is lacking a plate. The absence of these iron components from the rest of the group indicates that this buckle was perhaps not made locally, but possibly served as either a template or a specimen.

[21111/19] (Fig 11, 1) Thin sheeting; L36 x W16mm; tight fold lengthways (presumably hammered); the upper side of the central area is biconvex, though the lower side is of even width throughout (*ie* overall the biconvexity is not as evident as in the other frames recovered); rusted iron bar and incomplete iron pin.

### Stages of manufacture suggested for buckle plates and strapends

#### *Buckle plates*

It is uncertain which of Stages 2 or 3 was carried out first. The first four stages are the same as for strapends (see below):

- 1 Sheet rectangle cut out with shears (Fig 8, 1c).
- 2 Three-dimensional decoration stamped (the relative order in which 2 and 3 took place is uncertain) (Fig 8, 2c).
- 3 Coating added if appropriate (not illus).
- 4 Slot for pin and rebates cut out (Fig 8, 4c).
- 5 Folded in half (Fig 8, 5c).
- 6 Holes for rivets added — no buckle plates recovered in this state (Fig 8, 5c).
- 7 Some are tooled with further decoration (this could have happened at any stage after 2, but the greater investment in more-demanding skill might suggest it would be left until last to avoid discarding a component with labour-intensive engraving because of errors at other stages involving relatively simple work).
- 8 Add completed buckle, then the rivets to attach the plate onto the leather or fabric strap — no finds recovered in this state (Fig 8, 8c).

#### *Strapends*

The first four stages are the same as for buckle plates — lack of a slot for a pin and corner rebates are the most obvious differences in subsequent stages here.

- 1 Sheet rectangle cut to shape with shears (Fig 8, 1c).

- 2 Three-dimensional decoration stamped (the relative order in which 2 and 3 took place is uncertain).
- 3 Coating added if appropriate.
- 4 Outer end folded (Fig 8, 4d).
- 5 Holes for rivets added (Fig 8, 5d).
- 6 Some are tooled with further decoration (this could have happened at any stage after 2, but the greater investment in more-demanding skill might suggest it would be left until last to avoid discarding a component with labour-intensive engraving because of errors at other stages involving relatively simple work).
- 7 Rivets to attach plate onto strap added — no finds recovered in this state (Fig 8, 7d).

### Non-folded sheeting for either buckle plates or strapends

#### *Discarded during or after Stage 2 or 3*

These rectangular sheets had by definition not yet been folded, but [21111/76] has the shaping apparently uncompleted. This may be true of others here but it is clearest in this instance. Some examples had already been decorated with roundels or denticulated edges when they were discarded (Fig 8, 2c).

[21111/7] L53 x W21mm; 'black' coating on front face; cording along outside edge with finer cording on all edges, including engrailed inside edge; central pair of horizontal ridges (these continue part-way along the back).

[21111/11] L39 x W38mm; 'black' coating partially on front and traces on back; cording along intended fold, denticulated edge with adjoining strip of beading; back cut off at angle on one side.

[21111/38] (Fig 12, 2) L72 x W27mm; four roundels each containing a trefoil piercing; one group of piercings is noticeably off centre.

[21111/76] (Fig 12, 3) L38mm; this piece has a slightly tapered profile, one end is 13mm wide, the other is 16mm; cording along central fold and (finer) along inside edge; mark apparently of engraving tool registered along inside edge but has not cut through. It was discarded during Stage 2.

[21111/78] (Fig 12, 4) L38 x W33mm; cording along incipient fold; beading along denticulated edge.

[21111/86] (Fig 12, 1) L50 x W12mm; 'black' coating on both faces; cording along fold and both edges; outer edge nicked with slight denticulations; coating in centre on front has

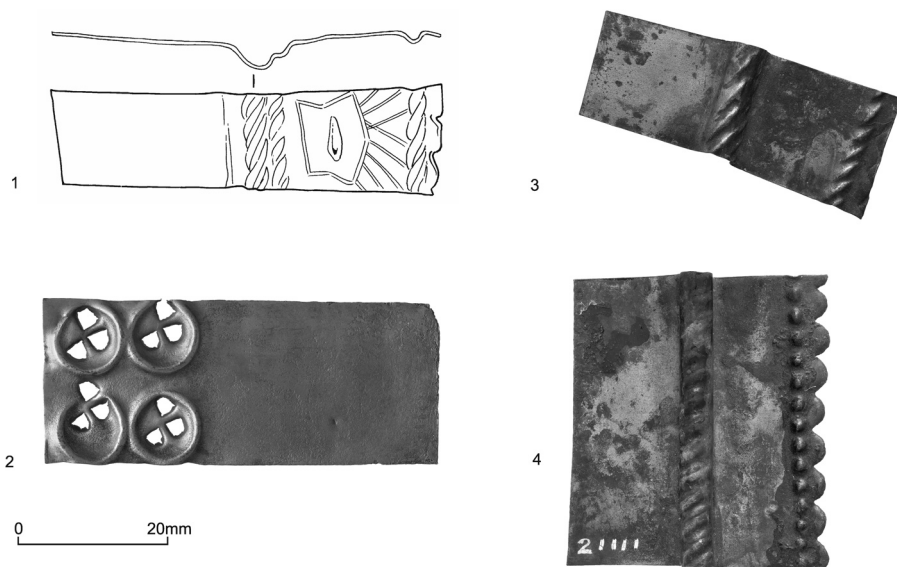

*Fig 12. Decorated sheet plates that have not been folded (either for buckle plates or strapends). 1. Black-coated, decorated with cording and scratched motif [21111/86]; 2. Four roundels each containing a trefoil piercing [21111/38]; 3. Cording along central fold and inside edge [21111/76]; 4. Beading along one denticulated edge, cording along incipient fold [21111/78]*

roughly scratched motif with radiating lines, three spots and an oval. The motif could possibly be seen as a child's rendition of a human face — hair, three eyes and a mouth. Compare with [21111/110] and (?stamped) motifs on buckle plate [21111/76].

[21111/113] L35 x W35mm; complete; 'black' coating mainly on front; cording along ridge marking position of intended fold; one denticulated edge.

[21111/115] L40 x W23mm; possible traces of 'black' coating on front; beading along inside edge.

### **Buckle plates**

All are of thin rectangular sheeting and have a slot for the pin; some examples are already folded (Fig 8, 4c and 5c). Unless indicated otherwise (see [21111/8] and [21111/129]) they have rebates in the corners of the outside edge. Some examples possess decorative motifs such as roundels on their front face or buckle side. The great variety in decoration at the most detailed level is notable. As with combinations of traits among the buckles, there are very few precise repeats. The full, unfolded, lengths are given of those that had

not, at the time of discard, been bent over (indicated as 'not folded' in the listings). A number of these items are decorated with stamped roundels containing either triple or quadruple punch-struck decoration, *eg* [21111/125] (Fig 15, 1) and [21111/51] (Fig 15, 4).

### *Discarded during or after Stage 4*

At this stage the rectangular slot for the buckle pin was cut out of the buckle plate and the two adjoining rebates along the line of the intended fold were also cut out (Fig 8, 4c).

[21111/2] L61 x W29mm; engrafted edges; central pair of horizontal ridges; and both faces black coated.

[21111/6] L61 x W29mm; not folded; 'black' coating on both faces; cording along sides and strap edge denticulated; beading along buckle edge; central pair of horizontal ridges.

[21111/8] L52 x W17mm; not folded (no corner rebates); 'black' coating on both faces; cording along all edges; strap edge denticulated.

[21111/16] (Fig 13, 1) L48 x W34mm; not folded; one edge denticulated (intended strap side) and decorated with row of six domed six-

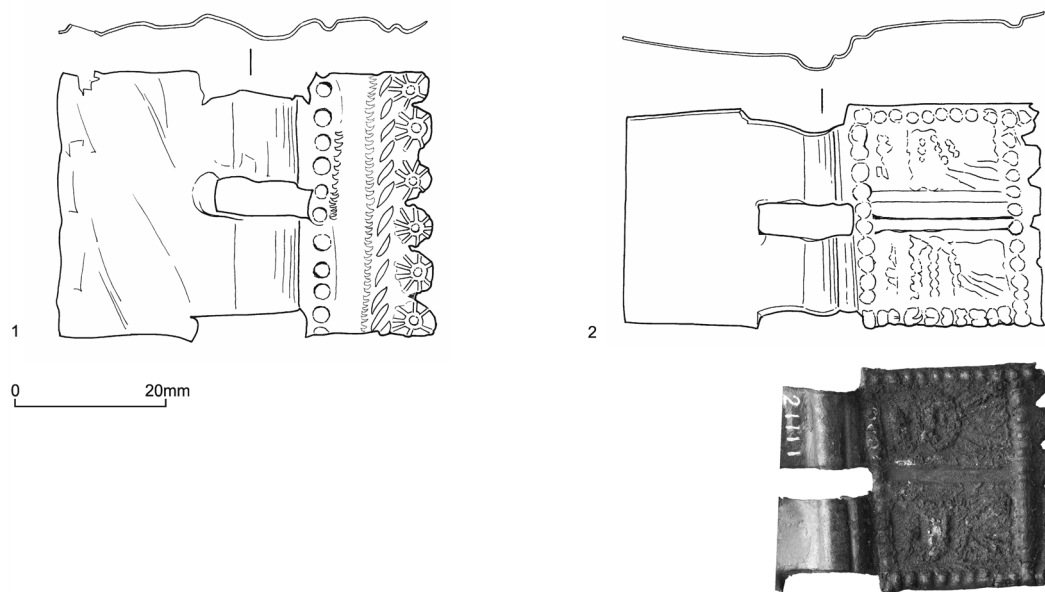

Fig 13. Decorated unfolded buckle plates with pin slots. 1. Denticulated along one edge which is also decorated with six domed six-foiled florets; internally there is beading, engraved zigzag and linear dots [21111/16]; 2. Edges beaded; 'black' coating on front, unfinished denticulation along one edge; the back, is moulded with a radiating pattern [21111/83]

foiled florets; other linear motifs present are cording, beading and zigzags.

[21111/21] L36 x W28mm; all edges engrailed; two roundels each with triple piercings; both faces black coated.

[21111/41] L34 x W22mm; no pin slot; cording along central fold; two vertical ridges and strap edge denticulated.

[21111/53] L48 x W18mm; not folded; rebates and pin slot cut out; pair of vertical ridges.

[21111/83] (Fig 13, 2) L55 x W29mm; not folded; four edges beaded; one with unfinished denticulations; 'black' coating on front; the back is moulded with a radiating pattern repeated in each of two horizontal panels defined by ridges. These curious decorative motifs look almost like two women in long, pleated dresses, with their arms held across their chests (see detail Fig 13, 2), though they would have to have been set sideways according to the centuries-long convention for orientating figurative representations on buckle plates (compare with the tooled motif, clearly abstract, on folded sheets [21111/110] and [21111/86]).

[21111/123] L34 x W29mm; both faces black coated; two roundels with triple piercings.

[21111/122] L44 x W17mm; not folded; cording along both edges; strap side engrailed.

[21111/125] (Fig 15, 1) L32 x W27mm; folded in half; beading along front edges; two overlapping central roundels with triple piercings.

[21111/129] L49 x W18mm; not folded (no rebates); beading along one edge and along centre horizontally; meandering engraved zigzag in upper field is obscured by now-black coating, of which there are traces on both faces.

#### Discarded during or after Stage 5

At this stage the buckle plates were folded in half (Fig 8, 5c). All decorative motifs are on the front face or buckle side.

[21111/1] (Fig 16, 5) L47 x W47mm; all edges beaded; strap side denticulated and also has an inner pair of ridges, this plus a central pair of horizontal ridges making a T-shaped arrangement.

[21111/134] (Fig 16, 1) L32 x W24mm; ridges along all edges, including strap side, on which engrailing has been effected by three half rings which have had their centres cut out to create a pronounced denticulated effect. The engrailing and denticulation on this piece have been effected by different means from that used elsewhere among the assemblage.

[21111/9] L33 x W27mm; cording along both

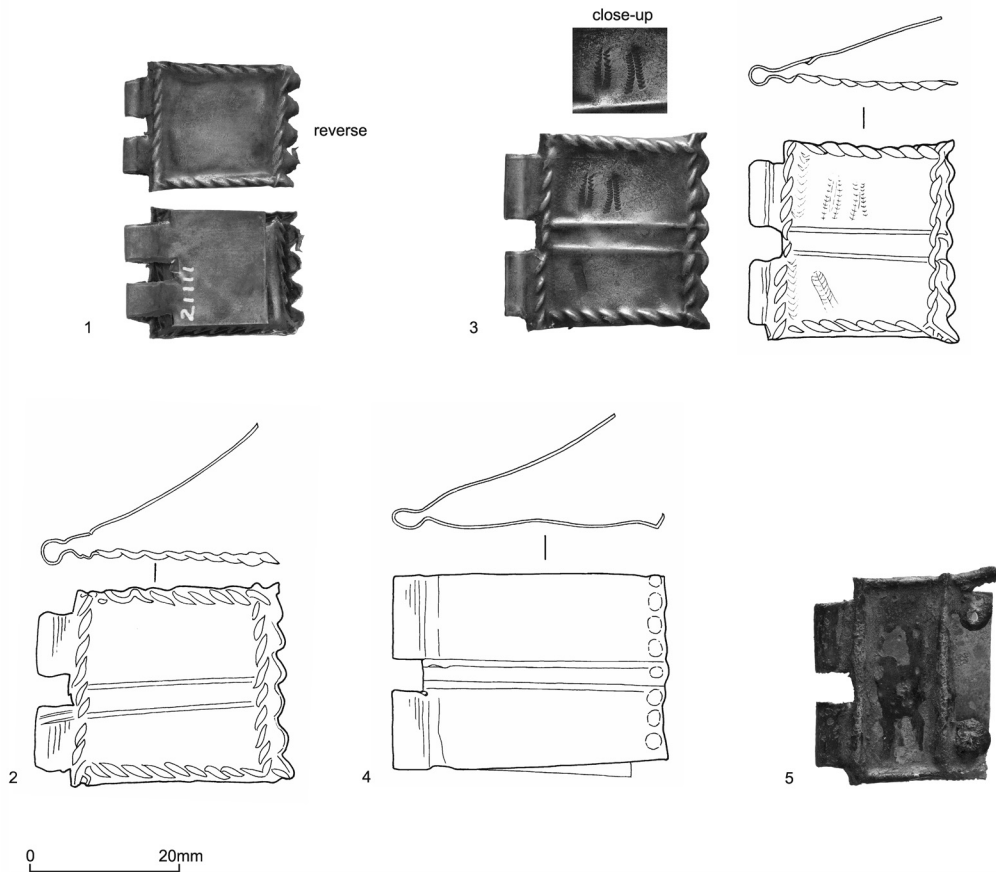

Fig 14. Decorated folded buckle plates with pin slots. 1. Cording along all edges and strap side denticulated (front and reverse views) [21111/80]; 2. Cording along all edges and strap side denticulated; central pair of horizontal ridges [21111/109]; 3. Cording along all edges and strap side denticulated; central pair of horizontal ridges and engraved zigzags [21111/18]; 4. Line along inside edge; beading along strap edge; central pair of horizontal ridges [21111/106]; 5. Traces of black coating on both faces; ridges along all edges; lateral spur and two domed roundels at strap side [21111/82]

sides and inside edge; beading along outside edge; two roundels each with trefoil piercings; the back has a tapered profile.

[21111/12] L35 x W27mm; 'black' coating survives on most of front and part of back; beading along all edges; central pair of horizontal ridges.

[21111/15] (Fig 16, 3) L33 x W10.5mm; beading along both edges, outer also denticulated; the main field has six minims in reserve against vertical lines of rough gouging with engraved horizontal zigzags between; four holes (each disc remains attached at one point) for two rivets (never attached). The minims were presumably intended to look like lettering to the illiterate (compare with [21111/47]).

[21111/14] L33 x W26mm; possible remains

of 'black' coating on both faces; otherwise essentially the same as [21111/9] (inside edges cut at slight angles).

[21111/18] (Fig 14, 3) L27 x W25mm; cording along all edges and strap edge denticulated; central pair of horizontal ridges; engraved zigzags along outside edge and incipient engraved zigzags in both panels (for false lettering compare [21111/47]).

[21111/36] L44 x W21.5mm; strap edge denticulated with additional pair of stamped ridges; stamped squares along all edges; central pair of stamped ridges.

[21111/45] (Fig 16, 4) L44 x W41mm; all edges beaded and strap edge denticulated; central pair of diagonal ridges.

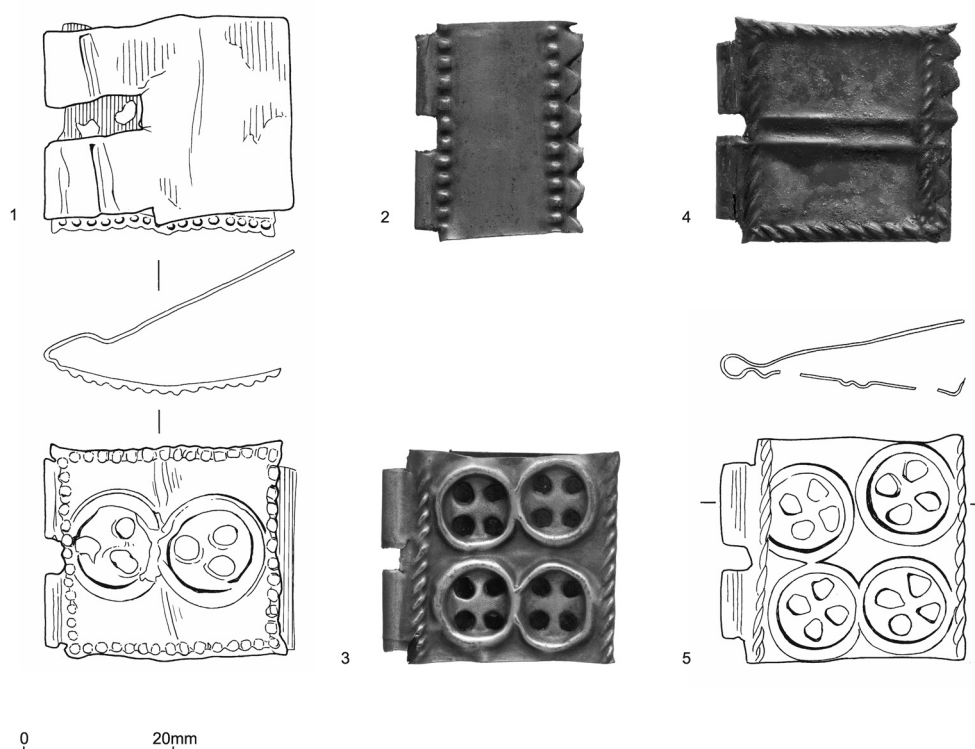

Fig 15. Decorated folded buckle plates with pin slots. 1. Beading along all edges and two roundels each with triple piercing [21111/125]; 2. Two parallel lines of beading, strap edge denticulated [21111/74]; 3. Cording along both buckle and strap sides; four roundels, each with quatrefoil punch-struck decoration [21111/52]; 4. Black-coated; cording along all edges; unfinished denticulations along strap side; central pair of horizontal ridges [21111/51]; 5. Cording along both buckle and strap sides; four roundels each with quadruple punch-struck decoration [21111/107]

[21111/47] (Fig 16, 2) L43 x W40mm; front distorted by folding: cording along all edges; strap edge denticulated; pair of horizontal ridges flanking strap edge and another pair in centre; the two fields thus defined are zigzag-engraved with minims (false lettering) between wavy lines, and rayed, internally stippled arc motifs near the inside edge. Compare with [21111/15] for the false lettering (Fig 16, 3).

[21111/51] (Fig 15, 4) L31 x W28mm; 'black' coating on both faces; cording along all edges; one denticulated edge; central pair of horizontal ridges.

[21111/52] (Fig 15, 3) L31 x W28mm; cording along both buckle and strap edges; four roundels, each with quatrefoil piercing.

[21111/62] L48 x W39mm; cording along all edges; central pair of horizontal ridges; strap edge also denticulated.

[21111/65] L30 x W26mm; cording along both

sides; four roundels arranged in two overlapping pairs; each roundel contains a trefoil piercing.

[21111/74] (Fig 15, 2) L28 x W22mm; two parallel lines of beading; strap edge denticulated.

[21111/80] (Fig 14, 1) L28 x W20mm; cording along all edges and strap edge denticulated. The back in particular indicates that there was some difficulty in cutting out the final, intricate shape of this component, possibly because the shears being used were blunt.

[21111/82] (Fig 14, 5) L24 x W26mm; traces of black coating on both faces; ridges along all edges; lateral spur and two domed roundels on strap side; probably from originally engrailed buckle side.

[21111/106] (Fig. 14, 4) L36 x W25mm; line along inside edge; strap edge beaded; central pair of horizontal ridges. It can be compared with [21111/24].

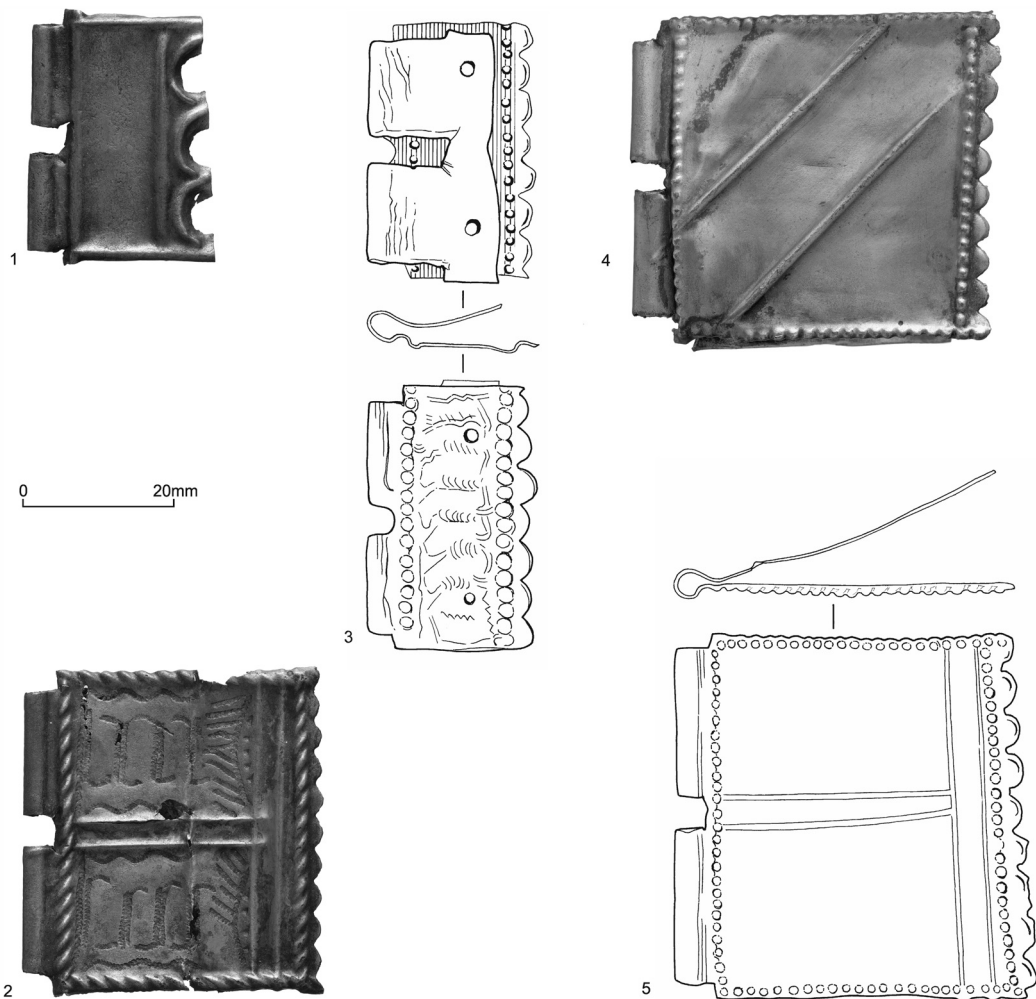

*Fig 16. Decorated folded buckle plates with pin slots. 1. Ridges along all edges, including strap side on which engraving has been effected by three half rings which have had their centres cut out to create a pronounced denticulated effect [21111/134]; 2. Cording along all edges; strap edge denticulated; T-shaped arrangement of two pairs of horizontal ridges; internal decoration minims and stippled rays [21111/47]; 3. Beading along buckle and strap side, latter also denticulated; the main field has six minims in reserve against vertical lines of rough gouging with engraved horizontal zigzags between; four holes (each disc remains attached at one point) for two rivets [21111/15]; 4. All edges beaded; strap side denticulated; central pair of diagonal ridges [21111/45]; 5. All edges beaded, strap side denticulated; central pair of horizontal ridges [21111/45]*

[21111/107] (Fig 15, 5) L31 x W29mm; cording along both edges of buckle side; four roundels each with quadruple piercing.

[21111/108] L64 x W26mm; both faces black coated; central pair of horizontal ridges.

[21111/109] (Fig 14, 2) L33 x W25mm; cording along all edges of buckle side; central pair of ridges at a slight angle to horizontal and strap edge denticulated.

[21111/118] L38 x W38mm; cording along all

edges; strap side denticulated; central pair of horizontal ridges.

[21111/121] L35 x W27mm; 'black' coating on both faces; beading along all edges; two roundels set horizontally, each with trefoil piercing. Compare with [21111/126] and [21111/123].

[21111/123] L34 x W29mm; similar to [21111/121].

[21111/124] L35 x W24mm; beading along

damaged edge; central pair of horizontal ridges. Compare with [21111/106] and [21111/108].

[21111/125] (Fig 15, 1) L32 x W27mm; beading along all edges and two roundels, each with triple piercing; similar to [21111/121]; may originally have had 'black' coating.

[21111/126] L32 x W29mm; similar to [21111/118], but coating absent from back of fold; two roundels each with triple piercing.

[21111/127] L30 x W27mm (incomplete); similar to [21111/109] but the front at least is of a redder alloy than other items here (the back is the usual yellowish colour).

[21111/128] L44 x W33mm; one side is damaged; there is 'black' coating on both faces; coarse beading along all edges, including inside edge (which has corners cut at angles); pair of large pierced holes, each with a perimeter arc of beading; central pair of horizontal ridges. The stamped decoration is paralleled on [21111/101].

[21111/131] L35 x W29mm; beading along all sides; pair of central horizontal ridges.

[21111/132] L>44 x W33mm incomplete and the inside edge is corroded; beading along edges; central pair of horizontal ridges.

### Fragments

The decorated ones are front plates, while the others could be back plates or perhaps front plates awaiting decoration.

[21111/100] Very thin sheeting; L34 x W24mm; possible rebate cut on one side.

[21111/102] L25 x W>23mm; similar to [21111/109].

[21111/130] Surviving L32 x W24mm; hint of rebates; no decoration.

### Strapends

All are of relatively thin or medium thickness sheeting. See [21111/86] (Fig 12, 1) *etc* for non-folded items that may have been intended for buckle plates or strapends. At Stage 4 the decorated strapends were folded (Fig 8, 4c). All decoration is assumed to have been on the front face of the strapend.

### Discarded after Stage 4

[21111/2] (Fig 18, 2) Thin sheeting; L40 x W33mm; beading and cording along fold; engraved row of four eight-foiled rosettes and beading along two other edges.

[21111/3] L29 x W25mm; 'black' coating on both faces; cording along fold, and (finer)

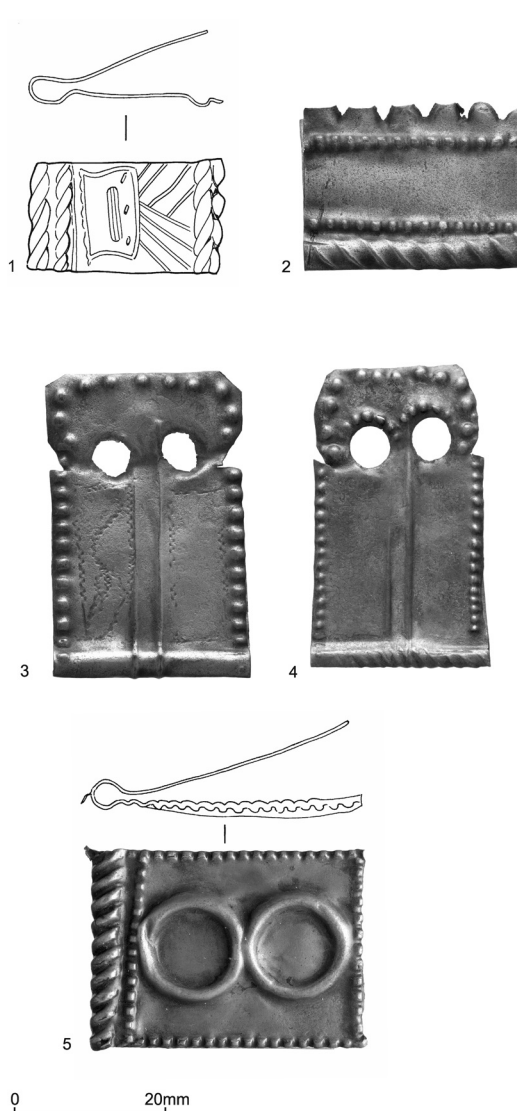

Fig 17. Decorated folded sheet strapends. 1. 'Black-coated' slightly tapered strip with twin banding of cording along both buckle and strap edges, scratched motif on interior [21111/110]; 2. Beading and cording along fold; beading along one other edge; strap edge has engraved row of four rosettes; denticulation [21111/40]; 3. Side nicks below pair of large holes; beading along sides and coarser along inside edge *etc*; central pair of horizontal ridges continuing onto back; the areas thus defined have meandering engraved zigzags [21111/70]; 4. Side nicks below pair of large holes, beading along sides and central pair of vertical ridges [21111/71]; 5. Cording along fold; beading along all edges; two large (plain) roundels [21111/13]

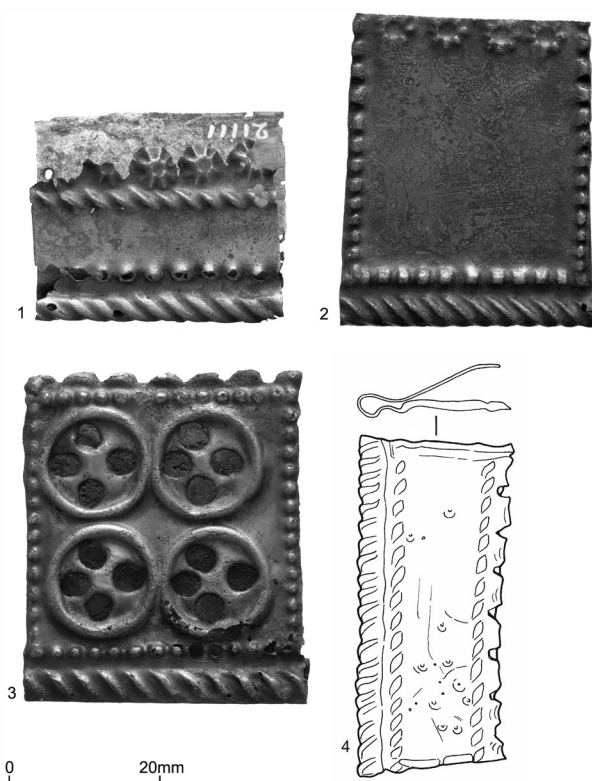

Fig 18. Decorated folded sheet strapends. 1. Strap edge engrailed with row of four domed eight-foiled rosettes, which have been half cut out creating a denticulated edge; beading and cording adjoining fold [21111/72]; 2. Beading and cording along fold, strap side engrailed with row of four eight-foiled florets; beading along two other edges [21111/2]; 3. Cording along fold; strap side denticulated; beading along all edges, four roundels with quadruple punch-struck decoration [21111/42]; 4. Cording along fold and (finer) along edges; strap side is slightly denticulated [21111/17]

along both edges; four roundels, each with triple piercing.

[21111/4] Relatively thick sheeting; 33 x 33mm; 'black' coating on both faces; cording along fold, and (finer) cording along other edges; central pair of vertical ridges.

[21111/13] (Fig 17, 5) L36 x W26mm; rectangular; cording along fold; beading along all edges; two large (plain) roundels.

[21111/15] L33 x W23mm; rectangular fragment.

[21111/16] (Fig 18, 3) L41 x W35mm; folded sheet, cording along fold; beading along all edges; strap edge denticulated; four roundels each with quadruple piercing.

[21111/17] (Fig 18, 4) L43 x W19mm; cording along fold and (finer) along edges; ridges along sides; strap edge marked by a series of small nicks, slight denticulation.

[21111/39] L38 x W16mm; rectangular sheet.

[21111/40] (Fig 17, 2) L28 x W21mm; rectangular; beading and cording along fold; beading along one other edge and unfinished denticulation along strap edge.

[21111/44] L36 x W20mm; folded sheet, one corner corroded; cording along fold; two parallel lines of beading.

[21111/59] L59 x W22 mm; rectangular sheet with one large stamped roundel, diameter 15mm.

[21111/63] L43 x W43mm; cording along fold and (finer) along all edges; pairs of horizontal ridges in centre and also along inside edge, making a T-shaped arrangement. The strap edge is denticulated.

[21111/64] L31 x W23mm; possible coating on inner face; cabling along fold and (finer) along edges; four overlapping roundels each with triple piercing.

[21111/70] (Fig 17, 3) Thin sheeting; L40 x W25mm; the back is markedly shorter than the front; inside edges cut at angles, side nicks below; pair of large holes; beading along sides and coarser along inside edge; central pair of horizontal ridges continuing onto back; the areas thus defined have meandering engraved zigzags.

[21111/71] (Fig 17, 4) L49 x W29mm; inside corners are cut at an angle, with side nicks lower down; cording along fold; pair of large holes, each with poorly aligned arc of coarse beading around part; finer beading along sides, and, larger and poorly aligned, along inside edge; central pair of vertical ridges; back is markedly shorter than front.



[21111/72] (Fig 18, 1) L32mm, the back portion of the folded sheet (29mm) is wider than the front (23mm); cording along fold; one line of beading close to fold and cording close to strap edge, which is decorated by a row of four eight-foiled florets (the fifth is missing due to corrosion), which had been half cut out, creating a denticulated edge. There are four tiny holes in the back, one of which may have been created with a sharp ended punch, but the other three are the result of corrosion. The front beading has also been holed by corrosion.

[21111/104] L46 x W38mm; 'black' coating on both faces; beading along all edges; strap side denticulated; central pair of vertical ridges and another pair flanking buckle side; neatly produced.

[21111/110] (Fig 17, 1) L50 x W14mm; slightly tapered strip of 'black' coating on both faces; twin bands of cording along fold and (finer) bands along strap edge; the inner face bears a similar scratched motif to that on [21111/86] (see there for possible interpretation).

[21111/111] L27 x W15mm; cording along fold; beading along all edges; strap edge denticulated; pair of stamped horizontal ridges in centre; back is crumpled, with a fragment missing.

[21111/112] Relatively thick sheeting; L32 x W26mm; similar decoration to that of [21111/111], except inside edge is plain.

[21111/114] L31 x W20mm; similar decorative scheme to that of [21111/116].

[21111/116] L28 x W20mm; beading along one edge.

[21111/117] L32 x W27mm; 'black' coating on both faces; cording along fold, and (finer) along all edges, including engrailed inside edge; central pair of vertical ridges.

#### Fragment

[21111/133] L>27 x W24mm; incomplete; 'black' coating on both faces; beading along sides; pair of central vertical ridges.

#### Rivet holes pierced

[21111/75] (Fig 19) Medium sheeting; L35 x W23mm; cording along fold; ridges along both sides, strap edge denticulated; there are two tiny punch-struck holes marking the intended position of two rivets (never set in place) near the denticulated edge.

#### Fragment of buckle plate or strapend

[21111/105] Fragmentary front plate only L43 x W>41mm; similar decoration to that on

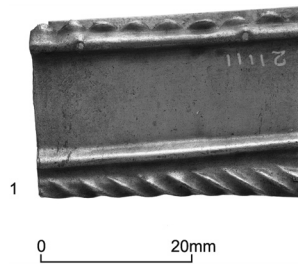

Fig 19. Decorated folded sheet strapend with cording along fold; ridges along both sides; strip edge denticulated and two rivet holes marked [21111/75]

[21111/1], except traces of 'black' coating on both faces, and beading along inside edge is rectangular.

#### Decorated sheet rectangles

The first example is unparalleled, while the other two could have been cut out from sheet plates — the reason for such treatment is unclear. While these objects were derived from either the manufacture of buckle plates or strapends more precise identification is not possible.

[21111/77] (Fig 20, 1) L22 x W19mm; 'black coated' with beaded edges and one roundel containing triple piercing; similar to [21111/119].

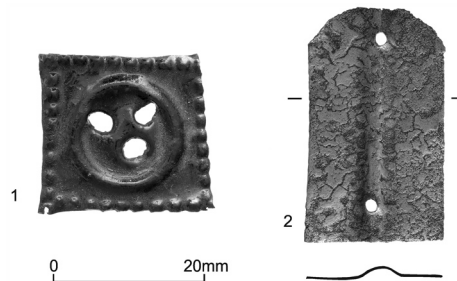

Fig 20. Decorated stamped sheet items. 1. Black-coated rectangle with beaded edges and one roundel containing triple piercing [21111/77]; 2. Shield-shaped item with a longitudinal central ridge with holes for two rivets [21111/35]

[21111/119] L21 x W19mm; 'black' coating on both faces; beading along all edges; roundel with triple piercing.

[21111/120] L32 x W25mm; 'black' coating on both faces; beading along all edges; two round-

els, each with triple piercing decoration; comparable with buckle plates [21111/121] and [21111/125].

#### *Sheet shield-like shapes*

All these pieces are thin sheeting, perhaps they are derived from composite strapends, but as no complete items are known this interpretation cannot be confirmed.

[21111/35] (Fig 20, 2) L30 x W18mm; superficially corroded with a longitudinal central ridge; punch-struck holes for two rivets (never put in place) near ends.

[21111/99] L28 x W20mm; angled corners at one end; central row of beading lengthways with domed eight-foiled florets at each end.

[21111/101] Fragment: surviving L32 x W18mm; angled corners at surviving end; roughly aligned coarse perimeter beading. Its shield-like shape suggests it was intended as a strapend; comparable with buckle plate [21111/128].

[21111/103] L30 x W23mm; angled corners at one end; four roundels, each with triple piercing.

#### **Mounts**

The function of these undecorated pieces is uncertain, it is possible that judging by the spacing of their rivet holes, they were components for a different type of buckle plate. The sequence of manufacture was:

- 1 Cut to shape and given three-dimensional decoration (two stages in one?).
- 2 Holes for rivets pierced.
- 3 Rivets set in place (no item recovered with these).

#### *Circular mounts*

[21111/73] (Fig 21, 1) Thin sheeting; disc, D15mm, with a large central hole (4mm diameter), and three smaller ones for rivets.

[21111/81] (Fig 21, 2) Cut down strip, surviving L19mm, W13mm; for retaining circular mount (D projected as 14mm), with small hole, possibly for rivet.

#### *Waste from cutting out six-foiled floret mounts*

These pieces of waste are all thin sheeting from which six-foiled florets with a diameter of 8mm have been cut. Interestingly [21111/60] is more wasteful in terms of unused metal than the other three examples.

[21111/33] L35 x W35mm; waste from which ten or eleven six-foiled florets have been cut in rows of five, four, three, two and one.

[21111/43] Two fragments of sheet from which six-foiled florets have been cut. Eight florets had been cut from the larger sheet (L27 x W9mm) and four from the smaller sheet (L11 x W6mm).

[21111/60] (Fig 21, 4) L43 x W13mm; rectangular strip from which four six-foiled florets have been cut in single row.

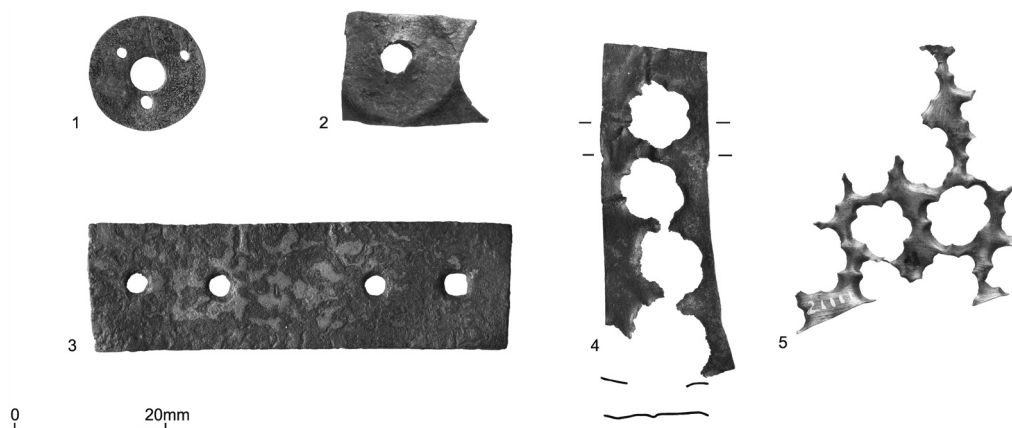

*Fig 21. Mounts and production waste. 1. Circular mount with central hole, and three smaller ones for rivets [21111/73]; 2. Cut down strip with small hole for retaining large circular mount [21111/81]; 3. Offcut strip with two pairs of countersunk holes along centre [21111/23]; 4. Strip from which four six-foiled florets have been cut in single row [21111/60]; 5. Sheet from which 15 six-foiled florets have been cut in rows of five, four, three, two and one [21111/61]*

[21111/61] (Fig 21, 5) L35 x W32mm; sheet from which 15 six-foiled florets have been cut in rows of five, four, three, two and one.

#### *Miscellaneous offcuts*

[21111/135] Two small corroded scraps; the larger one (L17 x W7mm) has a right-angled corner; the smaller one (L10 x W6mm) might be an end cut from a strip intended as a bow frame.

[21111/10] Damaged, thin strip sheet; L62 x W25mm; longest edge has a right-angled corner (surviving length of opposite edge is folded).

[21111/23] (Fig 21, 3) L66 x W20mm, with one end possibly broken off; it is a superficially corroded sheet rectangle of mixed alloy with redder and yellower areas; two pairs of counter-sunk holes (hole centres 12mm apart) along centre. The mixed colouration suggests a poor standard of production by the cementation process.

[21111/26] Thick sheeting; L79 x W6mm; elongated sub-trapezoidal; grooves along bevelled sides in thickest central portion.

[21111/28] Thin sheeting; L71 x W9mm; series of ragged cuts along one long edge; the rest of the perimeter is neatly cut.

[21111/89] Thin sheeting; W varies up to 43mm, surviving L39mm; two near-parallel (slightly divergent) edges.

#### **Discussion of the stamped motifs present in the sheet metalwork assemblage**

The formers used in stamping out the decorative motifs were presumably swages of some kind, probably of iron. Some kind of former may have been used to produce the neat, rounded folds for the outside edges of both buckles and strapends. Incidentally, it is likely that apart from the shears, the formers were the most expensive item of equipment involved in the manufacture of these buckles. The production of some details such as the roundels and their internal decoration would have been produced by a variety of hand-held iron punches.

There is evidence from elsewhere in the City of London for two of the processes used in the manufacture of these items. Excavations at the former City of London Boys' School revealed evidence of Stages 1 and 2 in the manufacture of buckle mounts, with three-dimensional stamping being applied to flat sheeting already cut to the

appropriate outline (Egan 1996a, 89, fig 4A). The Boy's School finds are of a similar date to the Trump Street assemblage.<sup>26</sup> The repertoire of basic shapes, which might be combined or curtailed, appears to be:

#### *Roundels*

These were produced by punching the rear side of the sheet metal with a circular hollow punch; the irregular arrangement of these roundels shows they were struck individually. Most of the roundels appear to have been created by two separate tools, presumably hollow punches, one with an internal diameter of 11–12mm (external diameter 16mm) ([21111/9, /13, /14, /121 and /126]), and the other with an internal diameter of 9mm ([21111/3 and /107]). The sequence of stamping between some pairs of roundels is discernible from overlaps such as Fig 15, 1. The roundels often contained a triple or quadruple arrangement of teardrop or oval shaped punch-struck depressions which had pierced through the sheeting. Some of these roundels such as the pairs on [21111/3] and [21111/107] (Fig 15, 5) have not been centrally placed and have a lopsided appearance. However, the roundels on Fig 15, 3 have been neatly orientated. The close similarity of the arrangement of the various trefoil piercings on Fig 12, 2 implies that each roundel was pierced *en bloc*.

#### *Plain ridges*

Various configurations, set horizontally, vertically or diagonally: framing lines, some paired, perhaps from a double-ridged tool. They occasionally continue on the back of the accessory (*eg* [21111/17]), showing the stamping was effected prior to folding.

#### *Rows of beading and engrailing*

These motifs generally appear in single rows around the margins of the pieces. The smaller beading appears to have been produced by a punch which created a parallel row of raised dots. However, the coarser or larger beads may have been produced singly.

#### *Rows of squares*

The margins of some pieces were decorated by rows of tiny squares, such as [21111/ 36].

*Cording*

There are at least two sizes of cording or cable moulding. The coarser type is often found along the folds of buckle plates or strapends. On one example, [21111/76] (Fig 12, 3), there was coarse cording along the fold and finer cording around the front edges.

*Six-foiled florets – for mounts*

Only offcuts were recovered. It is uncertain whether or not these products were flat or domed.

*Domed eight-foiled floret*

These possess a central pit and radiating lines; they form a decorative element in their own right. There are two different examples of this edge decoration: [21111/72] (Fig 18, 1), where the florets have been half cut out creating a denticulated effect, and the other where a row of florets adorns a straight edge [21111/2] (Fig 18, 2).

*Denticulation*

A number of buckle plates or strapends possessed one denticulated edge where the front of the piece would have originally fitted onto the strap. In one instance this motif was combined with matching engraving [21111/3] (Fig 16, 1).

*Other tooling: zigzag engraving*

This always appears in combination with stamping. On [21111/ 15] and [21111/ 47] (Fig 16, 2) this seems to have been used to suggest lettering.

**The ‘black’ coating on the sheet metal work**

A number pieces of sheet metal possess an even, shiny black (almost enamel-like) surface coating. In some instances this coating is matt and bubbled (perhaps burnt) — occasionally having lifted right off in limited areas (possibly the result of overheating). An experiment carried out by Arthur Trotman (late Conservator at the London Museum) at the request of Brian Spencer (late Director of the same) established that the same visual effect that is apparent on the excavated coated items can be achieved by heating linseed oil applied by a brush. This

is the method described in the 12th-century manual on metalworking and related crafts by Theophilus for applying a coating known during the Norman period as *vernis brun*, which gave a warm, dark brown or reddish colouring to copper alloy (Hawthorne & Smith 1979).<sup>27</sup> The residue on three pieces of metalwork has been studied by means of Infrared spectrometry by Raymond White of the National Gallery, Scientific Department. His study concluded that the coating was ‘probably a drying oil’, possibly linseed.<sup>28</sup> Low quantities of non-drying fats were detected in the samples; possibly this was the result of later contamination. It was concluded that ‘the black coating on the buckles could have been made as described by Theophilus, but there is no positive experimental evidence’ (Keene 1986). It was formerly assumed that a number of pieces of excavated sheet metal were originally coated with drying oil, and that their change in colour is presumably the result of degradation during burial (Arthur Trotman and Brian Spencer, pers comm; see Margeson 1993, 25). However, recent analysis of the black surface layer on object [21111/5] suggests that it is predominantly the result of sulphide corrosion products (see section on Metallurgy).

**Errors in manufacture**

Relatively few definable mistakes have been identified. Brass wire [21111/ 87] (Fig 11, 2) has possible indications of drawing difficulties. One incomplete sheet fragment [21111/100], which may have been intended as a buckle plate, could have been mis-cut, and the fold in [21111/74] (Fig 18, 1) may be slightly misplaced. Overall these are relatively trivial faults (if indeed they were regarded as such at all), most of which a casual customer might have overlooked.

**The metallurgy of the sheet metal work***Harriet White (English Heritage)*

Six samples were provided for examination to determine the type of copper alloy used for the manufacture of the buckles (Table 1). All samples were analysed by energy dispersive X-ray fluorescence (EDXRF) using an EDAX Eagle II machine run at 40kV with a current of 250µA and 100 second live time. Since EDXRF is a surface technique, a small area of

each sample (<2mm<sup>2</sup>) was cleaned to remove corrosion layers so that the core metal only was analysed. In the case of object [21111/5] both the core metal and black surface layer were analysed. Copper alloy classification relied only on the visual assessment of the relative heights of the characteristic peaks, and no attempt was made to quantify the amounts of the elements present in each object. Alloy nomenclature used follows that presented by Bayley (1991, 13–17): hence, brass refers to an alloy of copper and zinc, bronze to one of copper and tin, and gunmetal to copper containing both tin and zinc in significant amounts.

Table 1. Samples provided for analysis

Object	Description
[21111/24]	Unfinished buckle frame
[21111/31]	Unfinished buckle frame
[21111/20]	Finished buckle frame
[21111/36]	Buckle plate
[21111/69]	Buckle plate
[21111/5]	Buckle plate

The results show that in each case the major elements present were copper and zinc, with the addition of minor amounts of lead, while tin was not detected, indicating the buckles were manufactured from brass (Table 2). Previous analyses of late and post-medieval copper-alloy artefacts from London (including dress accessories, thimbles, sheet and wire) have revealed that by the 15th and 16th centuries brass was the most common copper alloy used for the manufacture of small everyday artefacts, with only a small number of objects made of bronze or gunmetal (Heyworth 1991; Blades 1995; Dungworth 2002). Moreover, the brass

artefacts analysed by Dungworth (2002, 8) contained minor amounts of lead (1.0 ± 0.9 wt% Pb). The compositions of the objects from the Trump Street well are therefore consistent with previous analyses of copper alloy compositions of similar metalwork from the same period.

A number of sheets of metal are described as having a 'black' coating. These pieces are assumed to have originally been covered with an organic substance to change the colour of the alloy, which has degraded to the black colour during burial (see above). Analysis of the black surface layer on object [21111/5] shows the presence of sulphur and iron in addition to the copper, zinc and minor amounts of lead noted in the metal core. This composition is suggestive that, in this case, the black layer is mainly sulphide corrosion products. This same phenomenon has been noted previously on copper-alloy artefacts recovered from London waterfront sites. In addition to copper- and lead-alloy objects covered with a dull gold coloured corrosion layer, copper-alloy artefacts were also recovered which are described as ranging in colour from brown-black to blue-black to black, and which have a varied texture, from soft or brittle layers which may be 'crusty', to a tenacious shiny black (Duncan & Ganiaris 1987, 110). Analysis of the surface layer of these objects by XRF and X-ray diffraction (XRD) showed them to be copper or copper/iron sulphides, and their formation is attributed to the presence of sulphate-reducing bacteria present in the anaerobic waterlogged soils of the waterfront sites.

### General discussion of the sheet metal-work industry

This manufacturing assemblage seems to be

Table 2. Results of the XRF analysis showing major and minor elements present

Object	Major elements	Minor elements
[21111/24]	Cu, Zn	Pb
[21111/31]	Cu, Zn	Pb
[21111/20]	Cu, Zn	Pb
[21111/36]	Cu, Zn	Pb
[21111/69]	Cu, Zn	Pb
[21111/5]	Core metal	Cu, Zn
	Black surface	Cu, S, Zn
		Pb
		Fe, Pb

the only substantial evidence for the production of a kind of buckle that was in its day innovative in conception, in that it was made largely by folding and cutting sheet metal and wire. The production of satisfactory frames and pins by this hand-craft method was no mean achievement (Fig 8). Perhaps more significantly, the obviation of the need for fixed plant — the furnace with its moulds and crucibles (not to mention large amounts of expensive fuel) — makes this innovative branch of the age-old dress-accessories industry stand out as perhaps the single most significant technological development (albeit arguably regressing to a 'lower' technical level) in its field during the medieval period, when new developments had largely been in terms of fashion alone. This new method of production was far cheaper than traditional casting, and it could be carried out virtually anywhere. All that was needed were the raw materials — sheeting and wire — and some formers, stamps, punches, and hammers, plus suitable pairs of pliers and shears, as well as a modicum of manual skill (Egan & Forsyth 1997, 217).

The most remarkable thing about this assemblage, despite the restricted number of categories of objects, is the extensive variety of trait differences. There are surprisingly few precise parallels within the material recovered ([21111/113], [21111/ 123] and [21111/ 126] are the most extensive series). Instead, different combinations of different traits within buckle plates and strapends particularly have been taken almost to an extreme. The usual pattern among sizeable manufacturing assemblages of overall repeated similarities in tiny details of craft production developed through 'habit of hand' by individual workers, is so understated here as arguably to be absent. The implications are uncertain — did the workers not last long at their tasks, or were so many individuals involved in the part of this industry that has been recovered that there are too many patterns to comprehend readily, or was it perhaps largely a child workforce that did not have the imperatives that adults habitually bring to bear on work.

The finds reflect the repertoire (though they probably do not define its entirety) and the level of skill of the unidentified workforce they represent. The diversity of practice at a

detailed level is surprising. There are very few completely identical items, and even looking at specific single traits for repeated patterns these are difficult to pin down. To put it another way, any habit-of-hand of individuals is less in evidence than widespread divergence. For instance, the 76 buckle plates and strapends comprise 44 different types (*ie* a gauge/coefficient of <2). This extreme might suggest a transient workforce of inexperienced individuals who had little time in practice to acquire appropriate manual skill, or workers too young to assimilate the complexities of their tasks by developing repeated actions, or there could be another explanation. The indication may be to some extent supported by the relatively high level of (non-disastrous) errors and slips evident throughout the group — bearing in mind that sub-standard items will inevitably have formed a large proportion of an assemblage of workshop discards.

A transient or inexperienced workforce might have been the result of either low pay or 'sweated labour'. The abuse of unorganised labour (that is to say people working outside the control of craft guilds and livery companies) was popularly known as the 'sweating system' and it was one of the causes of the London riots of 'Evil May Day' in 1517, along with the resentment of foreign craftsmen, and the import of cheap goods (Unwin 1963, 246–8). One contemporary pamphleteer observed that 30 years earlier 'poor handicraft people' had successfully manufactured and sold items such as 'pins, points, girdles, [and] gloves'. However, it was claimed that now the Haberdashers had monopolised the retailing of these items, they were able to buy them very cheaply from people working in 'alleys' or 'sitting in a poor chamber ...' (Unwin 1963, 249). The reason cited why these commodity prices were now so low was that the Haberdasher's shops 'lay stored full of [wares from] beyond sea' (Unwin 1963, 249). Curiously, the Trump Street buckle components were recovered *en masse* from the basal silts of a well so their disposal here seems very unlikely to have been accidental. Also the recovery of these items from the well would have been impossible. So it is tempting to interpret the deliberate disposal of these items as the result of an impetuous decision by one or more disgruntled persons working locally to

cease buckle manufacture. It is quite possible that this manufacturing process was being carried out at home (likely to have been an upstairs room) for a pittance. As these discarded components only contained a tiny amount of sheet metal they would have had possessed no scrap value.

The Trump Street sheet metalwork is not the only evidence of Tudor metalworking discovered within the locality. Evidence of non-ferrous 16th-century metalworking was discovered in the neighbouring tenement of Blossom's Inn (Fig 2), where the backfill of a barrel-lined soakaway contained crucible fragments and a number of ceramic mould fragments used for making copper-alloy knife handles.

The early 16th century was the period when London was developing an important role as an innovator, manufacturer and disseminator of goods. The distribution of comparable items is wide within England — almost as wide as it could be, but so far there are no finds of similar buckles on

the Continent. Buckle plates which seem to be identical (though this needs rigorous testing to see if it really does mean the same tools and templates were used) have been found in Norwich (Margeson 1993, 24–5, pls 8–9), Northampton (Oakley 1979, 251, 253, fig 108 no. 34, 257–8, fig 111 no. 88), Salisbury (Goodall forthcoming), and the Isle of Man (Egan 1996b, 30–1, fig 15 no. 2 – a buckle plate), with very similar items in Coventry (Egan 2005, 348–9, fig 163 nos 91–7, fig 164 nos 110–13). Another similar piece of sheeting has recently been reported from Beeleigh Abbey, Essex (Maldon Archaeological and Historical Group 2006, 9, fig 3). One of the Norwich finds introduces a complexity otherwise unattested, in that a sheet plate of the series holds a cast buckle frame (Margeson 1993, 27, fig 14 no. 147, with thick sheet pin) — this item could perhaps represent re-use of the plate. As noted above, a sole example of a sheet buckle pin using a slightly different method of folding is known from the Thames Exchange site.<sup>29</sup>

## APPENDIX: CATALOGUE OF GM 20, ER319 FINDS WITH THEIR MUSEUM OF LONDON ACCESSION NUMBERS CROSS-REFERENCED TO ILLUSTRATIONS AND TABLE 1

The animal bone is catalogued under ER319 bulk finds.

### *Bone and jet objects (not illus)*

[21553] bone knife handle  
[NN23865] jet rosary bead

### *Glassware (not illus)*

[21112/1]–[21112/5] bases of flasks or urinals  
[21112/6] flask or urinal rim fragment  
[21112/7] 3 flask or urinal rim fragments  
[21112/8] drinking glass fragment  
[21112/9] 18th-century wine bottle neck  
[21112/10] lobbed prunt from drinking glass  
[21112/11]–[21112/14] plain beaker fragments  
[21112/15] decorated (pinched trails) drinking glass fragment  
[21112/16] cylindrical beaker with decorated base  
[21112/21] urinal base  
[21112/22] 18th-century wine bottle neck  
[21114] green wine bottle with CM stamp

### *Leather (not illus)*

[21119] shoe fragments

### *Wooden objects*

Illustrated

Fig 4, 1 [21113] bowl fragments  
Fig 4, 2 [21105] bowl fragments  
Fig 4, 3 [21109] decorated spinning top  
Fig 4, 4 [21113] platter or trencher fragment (same Acc. as Fig 4, 1)

Fig 4, 5 [21562] oval box lid or gaming piece

Fig 4, 6 [21106] plain spinning top

Fig 4, 7 [21559] engraving tool handle

Fig 4, 8 [21104] comb

Fig 4, 9 [21137] cask headpiece

Fig 5, 1 [21555] sandglass stave fragment

Fig 5, 2 [21556] sandglass base

Not illustrated

[21107] platter fragment

[21108] cask headpiece

[21554] peg or stopper

[21557] block

[21558] bung or thick peg

[21560] split ball or knob

[21561] oval disc

### *Sheet brass metalwork*

[21111] is the generic Museum of London accession number for the sheet brass metalwork, individual objects are identified within this group by numerical suffixes. For details of metallurgical analysis see Table 1. Material currently on display in the Museum of London Medieval Gallery is denoted by \*.

Illustrated

Fig 7 [21111/79] sheet buckle frame

Fig 9, 1 [21111/29] sheet strip for buckle frame

Fig 9, 2 [21111/88] folded strip for buckle frame\*

- Fig 9, 3 [21111/55] folded strip for buckle frame  
 Fig 9, 4 [21111/50] folded strip for buckle frame (front and reverse views)\*  
 Fig 10, 1 [21111/22] folded/curved buckle frame  
 Fig 10, 2 [21111/37] folded/curved buckle frame  
 Fig 10, 3 [21111/1] folded/curved buckle frame  
 Fig 10, 4 [21111/57] folded/curved buckle frame  
 Fig 11, 1 [21111/19] complete buckle with iron bar  
 Fig 11, 2 [21111/87] wire perhaps for buckle frame bar or rivets  
 Fig 12, 1 [21111/86] 'black coated' unfolded sheet plate  
 Fig 12, 2 [21111/38] unfolded sheet plate\*  
 Fig 12, 3 [21111/76] unfolded sheet plate  
 Fig 12, 4 [21111/78] unfolded sheet plate  
 Fig 13, 1 [21111/16] unfolded slotted buckle plate  
 Fig 13, 2 [21111/83] unfolded slotted buckle plate and close-up photo  
 Fig 14, 1 [21111/80] folded buckle plate (front and reverse views)  
 Fig 14, 2 [21111/109] folded buckle plate  
 Fig 14, 3 [21111/18] folded buckle plate, drawing and photo plus close-up of decoration  
 Fig 14, 4 [21111/106] folded buckle plate  
 Fig 14, 5 [21111/82] 'black coated' folded buckle plate  
 Fig 15, 1 [21111/125] folded buckle plate (front and reverse views)  
 Fig 15, 2 [21111/74] folded buckle plate  
 Fig 15, 3 [21111/52] folded buckle plate\*  
 Fig 15, 4 [21111/51] 'black coated' folded buckle plate\*  
 Fig 15, 5 [21111/107] folded buckle plate  
 Fig 16, 1 [21111/134] folded buckle plate  
 Fig 16, 2 [21111/47] folded buckle plate\*  
 Fig 16, 3 [21111/15] folded buckle plate (front and reverse views)  
 Fig 16, 4 [21111/45] folded buckle plate\*  
 Fig 16, 5 [21111/1] folded buckle plate\*  
 Fig 17, 1 [21111/110] 'black coated' folded sheet strap end  
 Fig 17, 2 [21111/40] folded sheet strapend\*  
 Fig 17, 3 [21111/70] folded sheet strapend  
 Fig 17, 4 [21111/71] folded sheet strapend  
 Fig 17, 5 [21111/13] folded sheet strapend  
 Fig 18, 1 [21111/72] folded sheet strapend with eight-foiled floret denticulated edge decoration  
 Fig 18, 2 [21111/2] folded sheet strapend with floret edge decoration  
 Fig 18, 3 [21111/42] folded sheet strapend with roundel and piercing decoration\*  
 Fig 18, 4 [21111/17] folded sheet strapend  
 Fig 19 [21111/75] folded sheet strapend with rivet holes pierced  
 Fig 20, 1 [21111/77] 'black coated' rectangle with one roundel containing a triple piercing  
 Fig 20, 2 [21111/35] shield-shaped sheet  
 Fig 21, 1 [21111/73] circular mount  
 Fig 21, 2 [21111/81] strip retaining circular mount  
 Fig 21, 3 [21111/23] strip with counter sunk holes  
 Fig 21, 4 [21111/60] strip from which six-foiled floret mounts have been cut\*  
 Fig 21, 5 [21111/61] waste from cutting out six-foiled floret mounts\*  
 Not illustrated  
 [21111/3] 'black coated' folded strapend  
 [21111/4] folded strapend  
 [21111/5] 'black coated' buckle plate (Table 1)  
 [21111/6] 'black coated' buckle plate  
 [21111/7] unfolded sheet for either buckle plate or strapend  
 [21111/8] 'black coated' unfolded buckle plate  
 [21111/9] folded buckle plate  
 [21111/10] sheet waste  
 [21111/11] 'black coated' unfolded buckle plate or strapend  
 [21111/12] folded buckle plate  
 [21111/14] folded buckle plate  
 [21111/20] bent buckle frame (Table 1)  
 [21111/21] folded/curved buckle frame  
 [21111/24] folded strip (Table 1)  
 [21111/25] folded strip  
 [21111/26] sheet waste  
 [21111/27] sheet strip  
 [21111/28] sheet waste material  
 [21111/30] folded strip  
 [21111/31] folded strip (Table 1)  
 [21111/32] folded strip  
 [21111/33] sheet waste  
 [21111/34] sheet strip  
 [21111/35] buckle plate  
 [21111/36] folded buckle plate (Table 1)  
 [21111/39] folded sheet strip\*  
 [21111/41] folded buckle plate\*  
 [21111/43] two fragments of sheet waste  
 [21111/44] folded strapend\*  
 [21111/46] folded frame  
 [21111/48] bent frame with one broken end\*  
 [21111/49] sheet strip  
 [21111/53] unfolded buckle plate\*  
 [21111/54] sheet strip for frame, with flat ends folded in centre\*  
 [21111/55] sheet strip for frame\*  
 [21111/56] folded strip for frame  
 [21111/57] folded strip for frame  
 [21111/58] sheet strip bent frame, with flat ends folded in centre  
 [21111/59] stamped strap end  
 [21111/60] perforated waste  
 [21111/61] perforated waste  
 [21111/84] folded strip  
 [21111/85] sheet strip  
 [21111/89] sheet strip  
 [21111/90] sheet strip  
 [21111/91] sheet strip  
 [21111/92] sheet strip  
 [21111/93] folded strip  
 [21111/94] folded strip  
 [21111/95] folded strip  
 [21111/96] folded strip  
 [21111/97] folded strip  
 [21111/98] folded/curved buckle frame  
 [21111/99] shield-like sheet  
 [21111/100] decorated plate fragment



[2111/101] sheet shield-like shape, perhaps a strapend  
[2111/102] decorated plate fragment  
[2111/103] sheet shield-like shape  
[2111/104] 'black coated' folded strapend or buckle plate fragment  
[2111/105] fragment of buckle plate or strapend  
[2111/108] folded strip  
[2111/111] folded sheet strapend  
[2111/112] folded sheet strapend  
[2111/113] 'black coated' unfolded sheet  
[2111/114] folded sheet strapend  
[2111/115] unfolded sheet  
[2111/116] folded sheet strapend  
[2111/117] 'black coated' folded sheet strapend  
[2111/118] folded buckle plate  
[2111/119] 'black coated' decorated strip fragment  
[2111/120] 'black coated' decorated strip fragment  
[2111/121] 'black coated' folded buckle plate  
[2111/122] unfolded slotted buckle plate  
[2111/123] folded buckle plate  
[2111/124] folded buckle plate  
[2111/126] 'black coated' folded buckle plate  
[2111/127] buckle plate  
[2111/128] 'black coated' folded buckle plate  
[2111/129] 'black coated' unfolded slotted buckle plate

[2111/130] decorated plate fragment  
[2111/131] folded buckle plate  
[2111/132] folded buckle plate  
[2111/133] 'black coated' fragment of folded buckle plate  
[2111/135] sheet waste (2 fragments)  
Material on display at the Worshipful Company of Girdlers' Hall, EC2V  
Livery Hall, Basinghall Avenue, London EC2 (MOL loan ref 979)  
[2111/62] folded buckle plate  
[2111/63] folded sheet strapend  
[2111/64] folded sheet strapend  
[2111/65] folded buckle plate  
[2111/66] folded/curved buckle frame  
[2111/67] folded/curved buckle frame  
[2111/68] sheet strip  
[2111/69] folded buckle plate (Table 1)  
*Other metalwork*  
Illustrated  
Fig 6, 1 [21116] pewter spoon  
Fig 6, 2 [21117] hammered spherical lead object  
Not illustrated  
[21115] hammered oval lead disc  
[21118] copper-alloy pin

## ACKNOWLEDGEMENTS

The authors wish to thank the LAMAS Research Fund for sponsoring the research and production of this article. We also wish to thank: John Clark formerly of the Museum of London Early Department for sharing his research on the sheet metalwork with us; Jackie Keily of the Museum of London Early Department for her assistance during our research; Harriet White of English Heritage for her contribution on metallurgy; Ivor Noël Hume for his description of the circumstances of the 1956 fieldwork and also for providing a copy of Fig 3; David Bowsher (2008–12) and Peter Rowsome (2005–7) of MOLA for project management. The artefact photography was by Andy Chopping of MOLA; the finds drawings were produced by Sandra Rowntree of MOLA, Carlos Lemos of MOLA produced Fig 8; the site plans were produced by Mark Burch of MOLA.

While this article was in production Dr Geoffrey Egan, FSA passed away during December 2010. Geoff had an encyclopaedic knowledge of Tudor metalwork and dress accessories and it was his expertise which made the analysis and publication of the Trump Street metalwork possible.

brucenibwat@virginmedia.com

## NOTES

- <sup>1</sup> The quote is a late 16th-century English proverb.
- <sup>2</sup> The research archive for Blossom's Inn, Cheapside is held by the Museum of London Archaeological Archive and Research Centre (LAARC) WFG41.
- <sup>3</sup> The site archive for the 1956 fieldwork is held by LAARC, Guildhall Museum (GM) site 20, all contexts are recorded as Excavation Register entries, ER numbers. The finds from the Roman well are Excavation Register (ER) 359. The location of the well is given as the centre of the site.
- <sup>4</sup> The position of this well has been estimated from the site notes GM20 ER 361 page 23.
- <sup>5</sup> GM 20 ER 361 ID number [21137].
- <sup>6</sup> MoL Accession [21128–35]. The small selection of broken ceramics found in this well are now curated in the MoL's ceramic and glass store, images of which are available on the Museum's website by searching under their individual accession numbers.
- <sup>7</sup> GM 20 ER 361 MoL ID [21138].
- <sup>8</sup> GM 20 ER 361 ID [2114a–d]. The clay pipes have been identified in accordance with Atkinson & Oswald's 1969 classification and include Type 2 (1580–1610), Type 5 stamped bowl heel (1610–40) and Type 6 (1610–40).

<sup>9</sup> GM 20 ER 361 ID [21139, 21140].

<sup>10</sup> Site of Waxchandler's Hall (1956–7) GM75 ER360. The context of this material is uncertain; it was found in the south-west corner of the site by workmen.

<sup>11</sup> *Romeo and Juliet* (written 1595–6) Act V, scene 1. 'I do remember an apothecary, — and hereabouts he dwells, — which late I noted, In tatter'd weeds, with overwhelming brows, Culling of simples; meagre were his looks, Sharp misery had worn him to the bones; And in his needy shop a tortoise hung ... and about his shelves, A beggarly account of empty boxes' (Shakespeare 1947, 274).

<sup>12</sup> GM 20 ER 319 notes page 77.

<sup>13</sup> See sketch cross-section and plan in site notes GM 20 page 76.

<sup>14</sup> GM 20 ER 319.

<sup>15</sup> The upper fill was catalogued as part of GM 20 ER 319, the two 18th-century bottles may have been derived from this deposit. In the site notes (GM20 pages 75–6) it is suggested that the tiles were probably of 16th-century date and it is stated that a 17th-century bottle was found in the upper fill.

<sup>16</sup> Photographed by Noël Hume in 1956.

<sup>17</sup> MoL Accession number [21124].

<sup>18</sup> GHT00 (medieval land use) Buildings 74 and 75.

<sup>19</sup> The documentary survey of the Blossom's Inn properties by Tony Dyson (2001) forms part of the GHT00 site archive; aspects of this data will be included in the monograph publication (Watson *et al* in prep). The number sequence used continues the scheme adopted by Colin Taylor for 1–10 Milk Street properties (Schofield *et al* 1990 131–48).

<sup>20</sup> The animal bones were identified by Barbara West in 1979 see GM 20 ER 319 site records.

<sup>21</sup> The context of these beads is not known, but their state of preservation suggests that they were recovered from the waterlogged fills of either a cesspit or a well, Museum of London accession number 5079.

<sup>22</sup> No species identification available.

<sup>23</sup> Finds from (MIL72) 76–10 Milk Street; (MLK76) 1–6 Milk Street and Blossom's Inn 1930 GM 254 ID 1269. The MLK 76 glassware consisted of a 13th-century urinal from cesspit 116 and late 16th-century finds from cesspit 120, consisting of 2 flasks, a urinal, a phial and a beaker (Schofield *et al* 1990, 218–19).

<sup>24</sup> GM254 ID 12690A.

<sup>25</sup> Thames Exchange, Upper Thames Street,

City of London (unanalysed and unpublished fieldwork 1988–89), site code TEX88, Museum of London Acc. No. 4274.

<sup>26</sup> Former City of London Boys' School, Victoria Embankment, City of London (unpublished fieldwork 1986–87), site code BOY86, Museum of London Acc. Nos 187 and 188.

<sup>27</sup> Theophilus (ch 71) *How to put a black coating on copper*. Linseed oil was brushed onto a piece of sheet metal and then the metal heated over a flame. A shiny black coating, adhering well to the metal, resulted. Repeated applications resulted in a darker finish. Highlights could be produced by selectively scraping the metalwork.

<sup>28</sup> This 1986 study was apparently a private piece of work, which was never the subject of a National Gallery Scientific Department report.

<sup>29</sup> See note 25.

## BIBLIOGRAPHY

- ATKINSON & OSWALD (1969), D Atkinson & A Oswald 'London clay tobacco types' *Journ Brit Archaeol Assoc* 3rd series, 32, 171–227
- BAYLEY (1991), J Bayley 'Alloy nomenclature' in Egan & Pritchard (1991), 13–17
- BLADES (1995), N Blades *Copper Alloys from English Archaeological Sites 400–1600 AD: An Analytical Study Using ICP-AES* unpub PhD Thesis, University of London
- BLAIR & WATSON (2005), I Blair & B Watson *Blossom's Inn, 30 Gresham Street, EC2, City of London: a Post-excavation Assessment and Updated Project Design* unpub MoLAS report (GHT00)
- BLAIR & WATSON (in prep), I Blair & B Watson with J Pearce 'The Great Fire of London: Ivor Noël Hume's investigation of the 17th-century material culture of the metropolis' in E Klingelhofer (ed) *English Material Culture in the Early Atlantic World: Essays in Honour of Ivor Noël Hume*
- BRIDGEN (1989), S Bridgen *London and the Ref-ormation*
- DUNCAN & GANIARIS (1987), S Duncan & H Ganiaris 'Some sulphide corrosion products on copper alloys and lead alloys from London waterfront sites' in J Black (ed) *Recent Advances in the Conservation and Analysis of Artefacts, Jubilee Conservation Conference Papers*, 109–18
- DUNGWORTH (2002), D Dungworth *Analysis of Post-medieval Lead, Tin, Copper Alloy and Glass Artefacts from Southwark* Centre for Archaeology Report 64/2002
- DYSON (2001), T Dyson *Blossom's Inn, 20–30 Gresham Street, 20–23 Lawrence Lane, 3–6 Trump Street, 1–10 Milk Street & Mumford Court, London EC1: Documentary Survey*, part of GHT00 site archive

- EGAN (1996a), G Egan 'Some archaeological evidence for metalworking in London c.1050 AD–c.1700 AD' *Historical Metallurgy* 30.2, 83–93
- EGAN (1996b), G Egan 'Non-ferrous metal' in P Davey, D J Freke & D A Higgins (eds) *Excavations at Castletown Isle of Man 1989–1992*, 29–35
- EGAN (1997), G Egan 'Non-ceramic finds' in C Thomas, B Sloane & C Phillpotts *Excavations at the Priory and Hospital of St Mary Spital, London* MoLAS Monograph 1, 201–15
- EGAN (2005), G Egan, 'Observations on some of the small finds: section 5 black-coated sheet copper alloy finds' in P Woodfield *The Church of Our Lady of Mount Carmel and Some Conventual Buildings at the Whitefriars, Coventry* British Archaeol Report 389, 348–9
- EGAN & FORSYTH (1997), G Egan & H Forsyth 'Wound wire and sliver gilt; changing fashions in dress accessories c.1400–c.1600' in D Gaimster & P Stamper (eds) *The Age of Transition: the Archaeology of English Culture 1400–1600* Soc Medieval Archaeol Monograph 15 and Oxbow Monograph 98, 215–38
- EGAN & PRITCHARD (1991), G Egan & F Pritchard *Dress Accessories: Medieval Finds from Excavations in London Vol 3*
- FOISTER (2003), S Foister 'Private devotion' in R Marks & P Williamson (eds) *Gothic: Art for England 1400–1547*, 334–47
- GARDINER (2005), J Gardiner with M J Allen (eds) *Before the Mast: Life and Death Aboard the Mary Rose* Archaeology of the Mary Rose vol 4
- GOODALL (1981), A R Goodall 'The medieval bronzesmith and his products' in D W Crossley (ed) *Medieval Industry* CBA Res Rep 44, 63–71
- GOODALL (forthcoming), A R Goodall 'Copper alloy dress accessories' in *Salisbury and South Wiltshire Museum Medieval Catalogue 4*
- GRIMES (1968), W F Grimes *The Excavation of Roman and Mediaeval London*
- HAWTHORNE & SMITH (1979), J G Hawthorne & C S Smith (ed & trans) *On Divers Arts: The Treatise of Theophilus*
- HEYWORTH (1991), M Heyworth 'Metallurgical analysis of the dress accessories' in Egan & Pritchard (1991), 387–95
- HURST *et al* (1968), J D Hurst, D S Neal & H J E van Beuningen *Pottery Produced and Traded in North-West Europe 1350–1650* Rotterdam Paper 6
- KEENE (1986), S Keene *MoL Conservation Department Technical Report on Study of the Black Coating on Late Medieval Copper Alloy Buckles (Acc No 21111)*, Copy in LAARC (part of GM20 archive)
- KEILY (2007), J Keily 'Wooden objects from phase 2 backfilling of the city ditch (OA 17) and the revetment (S6) within the city ditch' in J Lyon *Within These Walls: Roman and Medieval Defences North of Newgate at the Merrill Lynch Financial Centre, City of London* MoLAS Monograph 33, 88–90
- MALDON ARCHAEOLOGICAL & HIST GROUP (2006), Maldon Archaeological and Historical Group 'Excavations at Beeleigh Abbey: 2001–2005' *CBA Mid Anglia Newsletter* Autumn 2006, 8–10
- MARGESON (1993), S Margeson (ed) *Norwich Households: the Medieval and Post-medieval Finds from Norwich Survey Excavations 1971–8* East Anglian Archaeol Report 58
- MOORHOUSE (1972), S Moorhouse 'Medieval distilling-apparatus of glass and pottery' *Medieval Archaeology* 16, 79–121
- MORRIS (1983), C Morris 'Wooden objects' in C Heighway *The East and North Gates of Gloucester* Western Archaeol Trust Monograph 4, 206–10
- MURDOCH (1991), T Murdoch (compiler) *Treasure and Trinkets: Jewellery in London from Pre-Roman Times to the 1930s*
- NOËL HUME (1969a), I Noël Hume *Historical Archaeology*
- NOËL HUME (1969b), I Noël Hume *The Wells of Williamsburg: Colonial Time Capsules* (1st edn)
- NOËL HUME (1996), I Noël Hume *In Search of This and That*
- OAKLEY (1979), G E Oakley 'The copper alloy objects and the lead alloy objects' in J H Williams *St Peter's Street, Northampton, Excavations 1973–1976* Northampton Development Corporation Monograph 2, 248–67
- PEARCE (2002), J Pearce 'The industrial ceramics' in E Howe *Roman Defences and Medieval Industry: Excavations at Baltic House, City of London* MoLAS Monograph 7, 61–5
- PORTER (1997), R Porter *The Greatest Benefit to Mankind: A Medieval History of Humanity from Antiquity to the Present*
- PRICE (1873), J E Price *Roman Antiquities Recently Discovered on the Site of the National Safe Deposit Co's Premises*
- RICHARDS & STIMSON (2005), M Richards & A Stimson 'Sandglasses' in Gardiner (2005), 281–4
- RODRIGUES (2005), J Rodrigues 'Staved containers (casks)' in Gardiner (2005), 409–21
- SCHOFIELD *et al* (1990), J Schofield, P Allen & C Taylor 'Medieval buildings and property development in the Cheapside' *Trans London Middlesex Archaeol Soc* 41, 39–237
- SHAKESPEARE (1947), W Shakespeare *The Works of William Shakespeare: gathered into one volume*
- SHEPHERD (1998), J Shepherd (ed) *Post-War Archaeology in the City of London 1946–72: A Guide to the Records of Excavations by Professor W F Grimes held by the Museum of London* Archaeology Gazetteer Series Vol 3

- SINGER *et al* (1957), C Singer, E J Holmyard, A R Hall & T I Williams (eds) *A History of Technology, vol 3: from the Renaissance to the Industrial Revolution c 1500–1750*
- STOW (1971), *A Survey of London (1603)* ed C L Kingsford (2 vols)
- TYSON (2000), R Tyson *Medieval Glass Vessels Found in England cAD 1200–1500* CBA Research Report 121
- UNWIN (1963), G Unwin *The Guilds and Companies of London* (4th edn)
- WATSON *et al* (in prep), B Watson *et al* *Wells and Water: Roman and Later Excavations at 20–30 Gresham Street and Blossom’s Inn, City of London EC2* MoLA monograph
- WEINSTEIN (2005), R Weinstein ‘Eating and drinking vessels and utensils’ in Gardiner (2005), 448–58
- WILLMOTT (2002), H Willmott *Early Post-medieval Vessel Glass in England c1500–1670* CBA Research Report 132
- WOOD (2005), R Wood with J Hather ‘The turned woodware from the *Mary Rose*’ in Gardiner (2005), 478–89