



**An Archaeological Evaluation at
Broadnook Garden Suburb, North of
Birstall**

**Wanlip, Rothley, Thurcaston and
Cropston Parishes**

**Leicestershire
NGR: SK 582 113**

Adam Clapton



ULAS Report No 2017-192

© ULAS 2017

**An Archaeological Evaluation at Broadnook Garden Suburb, North of Birstall
Wanlip, Rothley, Thurcaston and Cropston Parishes**

Leicestershire

NGR: SK 582 113

Adam Clapton

For: Palmer-Tomkinson Trust and Cooper Family

Filename/Version	Checked by	Date
2017-192 draft	Vicki Score 	6/12/2017
2017-192	Vicki Score	29/05/2018

University of Leicester, Archaeological Services, University Rd., Leicester, LE1 7RH

Tel: (0116) 2522848

www.le.ac.uk/ulas

ULAS Report Number 2017-192

© ULAS 2017

Contents

Summary	1
Introduction	1
Site Description, Topography and Geology	2
Archaeological and Historical background	4
Archaeological Aims and Objectives	5
Methodology.....	6
Results.....	8
Trench 3	14
Trench 4	16
Trench 8	19
Trench 9	21
Trench 10	25
Trench 41	28
Trench 44	30
Middle-Late Iron Age Pottery	32
Animal Bone.....	34
The Charred Plant Remains.....	38
Discussion and Conclusions	39
Recommendations and further work.....	41
Archive	44
Publication	44
Bibliography	45
Acknowledgments.....	46
Oasis Data	46

Table of Figures

Figure 1: Site Location.....	3
Figure 2: Location of site showing overall planning application boundary (red) and area subject to detailed proposals (blue).....	3
Figure 3: Previous archaeological work in the area.....	4
Figure 4: Plan of study area subject to geophysical survey with anomalies identified (red). Taken from Phase Site Investigations, 2013.....	5
Figure 5: Trench locations	7
Figure 6: Trenches 1, 2,5,6,7,11,12,13 and 14.....	10
Figure 7: Trenches 15-23	10

Figure 8: Trenches 24-32	11
Figure 9: Trenches 33-40 and 42	11
Figure 10: Trench 43.....	12
Figure 11: Trenches 45-48.....	12
Figure 12: Plan of trenches. Blank trenches are shown in black and trenches containing archaeology are shown in blue	13
Figure 13: Trench 3 looking north.....	14
Figure 14: Posthole [19] looking east (0.5m scale)	14
Figure 15: Trench 3 plans and sections.....	15
Figure 16: Trench 4 looking north east (1m scale).....	16
Figure 17: Gully [1] and linear [6] looking north (0.5m and 1m scales).....	16
Figure 18: Pit/linear [15] with fire cracked stones (top) and with fire cracked stones removed (bottom) looking south (1m scale).....	17
Figure 19: Trench 4 plans and sections.....	18
Figure 20: Trench 8 looking south west (1m scale).....	19
Figure 21: Posthole [16] looking south east (0.30m scale).....	19
Figure 22: Trench 8 plans and sections.....	20
Figure 23: Location of trench 9 on geophysical survey data of area.	21
Figure 24: Trench 9 looking north-west (1m scale).....	21
Figure 25: Gully [21] looking north-west (1m and 0.5m scale) and linear [24] looking north-east (1m and 0.5m scale)	22
Figure 26: Ditch [31] looking north-west (1m and 0.5m scale).....	23
Figure 27: Trench 9 plans and sections.....	24
Figure 28: Location of trench 10 (left) and geophysical survey data of area (right)	25
Figure 29: Trench 10 looking north-west (1m scale).....	25
Figure 30: Ditch [25] looking north (2m scale) and gully [33] looking north-east (1m scale).....	26
Figure 31: Trench 10 plans and sections.....	27
Figure 32: Trench 41 looking north-east (1m scale).....	28
Figure 33: [8] looking south (1m scale).....	28
Figure 34: Trench 41 plans and sections.....	29
Figure 35: Trench 44 looking north-east (1m scale).....	30
Figure 36: Posthole [11] looking south-west and posthole [13] looking south (0.3m scale).....	30
Figure 37: Trench 44 plans and sections.....	31
Figure 38: <i>Typology of vessel forms from Grove Farm, Enderby (Elsdon 1992b, illus 24)</i>	33
Figure 39: Barbed and tanged arrowhead (0.10m scale).....	37
Figure 40: Ad hoc axe (0.15m scale)	37
Figure 41: Trenches with undated archaeology in blue, Iron Age archaeology in orange and blank trenches in black	40
Figure 42: Areas of Archaeological potential.	42
Figure 43: Areas of Archaeological potential overlain on illustrative masterplan.	42
Figure 44: Details of Iron Age enclosure around Trenches 8-10.....	43

An Archaeological Evaluation at Broadnook Garden Suburb, North of Birstall Wanlip, Rothley, Thurcaston and Cropston Parishes

Summary

An archaeological field evaluation was carried out by University of Leicester Archaeological Services (ULAS) on land to the north of Birstall in the parishes of Wanlip, Thurcaston, Rothley and Cropston (in the Borough of Charnwood) Leicestershire.

The work was commissioned in advance of a Sustainable Urban Extension (SUE) ('Broadnook') of up to 1650 dwellings, up to 15ha of employment land, local centre, community resource centre, reserved land for travelling show people sites, primary school, allotments, open space and associated works. Full permission is being sought as part of the hybrid application for road infrastructure, 193 dwellings, a country park, open space and landscaping.

A heritage assessment and geophysical survey have previously been undertaken which identified archaeological potential and located anomalies, some of possible archaeological origin.

The site consists of several fields to the north of Birstall. Forty-eight trenches were excavated across the area of proposed development with archaeological features in 7 of the 48 trenches. This includes an area containing a probable Iron Age enclosure with features suggesting settlement. Features included gullies, ditches and postholes with diagnostic sherds of pottery indicating a Middle-Late Iron Age date. A second area to the south-west containing undated features may be an earlier phase of activity. Three other trenches contained isolated features in the western part of the site.

The archive for this site will be deposited with Leicestershire County Museums with accession number X.A113.2017.

Introduction

A hybrid planning application has been submitted to Charnwood Borough Council which proposes a Sustainable Urban Extension (SUE) (the 'Broadnook Garden Suburbs') of up to 1650 dwellings, up to 15ha of employment land, local centre, community resource centre, reserved land for travelling show people sites, primary school, allotments, open space and associated works. The proposal is identified as a strategic priority in the Charnwood Local Plan Core Strategy 2011 to 2028. Full permission is sought as part of the hybrid application for road infrastructure, 193 dwellings, a country park, open space and landscaping (Planning Ref: P/16/1660/2). As part of the pre-determination evaluation a programme of archaeological work comprising trial trenching has been carried out to determine the impact of the proposed scheme on any buried archaeology and produce a mitigation strategy for the site.

This report represents the programme of archaeological trial trenching that was undertaken in October 2017. It follows an archaeological heritage assessment (Prospect Archaeology WDA01/LPA-29), geophysical survey (Phase Site Investigations ref ARC_1010_405) and a strategy of work set out in the Written Scheme of Investigation for Evaluation (WSI, Hunt 2017).

The work involved the machine excavation of 48, 30m long trial trenches located where constraints allowed throughout the development. Trenches were focused on the proposed access roads into the site, the areas of known archaeological activity and areas containing anomalies possibly associated with archaeological remains identified during the geophysical survey.

The archaeological evaluation was undertaken in accordance with National Planning Policy Framework Section 12: Conserving and Enhancing the Historic Environment (DCLG March 2012). All archaeological work was in accordance with the Chartered Institute for Archaeologists (CIfA) Code of Conduct (2014) and adhered to their *Standard and Guidance for Archaeological Field Evaluation* (2014).

Site Description, Topography and Geology

The site is located to the north of Birstall close to the junction of the A46 Western Bypass and the A6, and lies within the parishes of Rothley (to the north), Wanlip (to the east) and Thurcaston and Cropston (to the west) (Fig. 1). The land is currently mostly arable land, with some areas of woodland and pasture and comprises several enclosed fields covering around 204ha (Fig. 2). The land broadly rises from approximately 60m aOD, from north-east to the centre of the site, then falls to the south-west to around 70m aOD, with the centre of the site reaching around 90m aOD.

The British geological Survey website indicates that the underlying geology is likely to be Edwalton Member mudstone overlain by Oadby Member Diamicton with some patches of Colluvium.

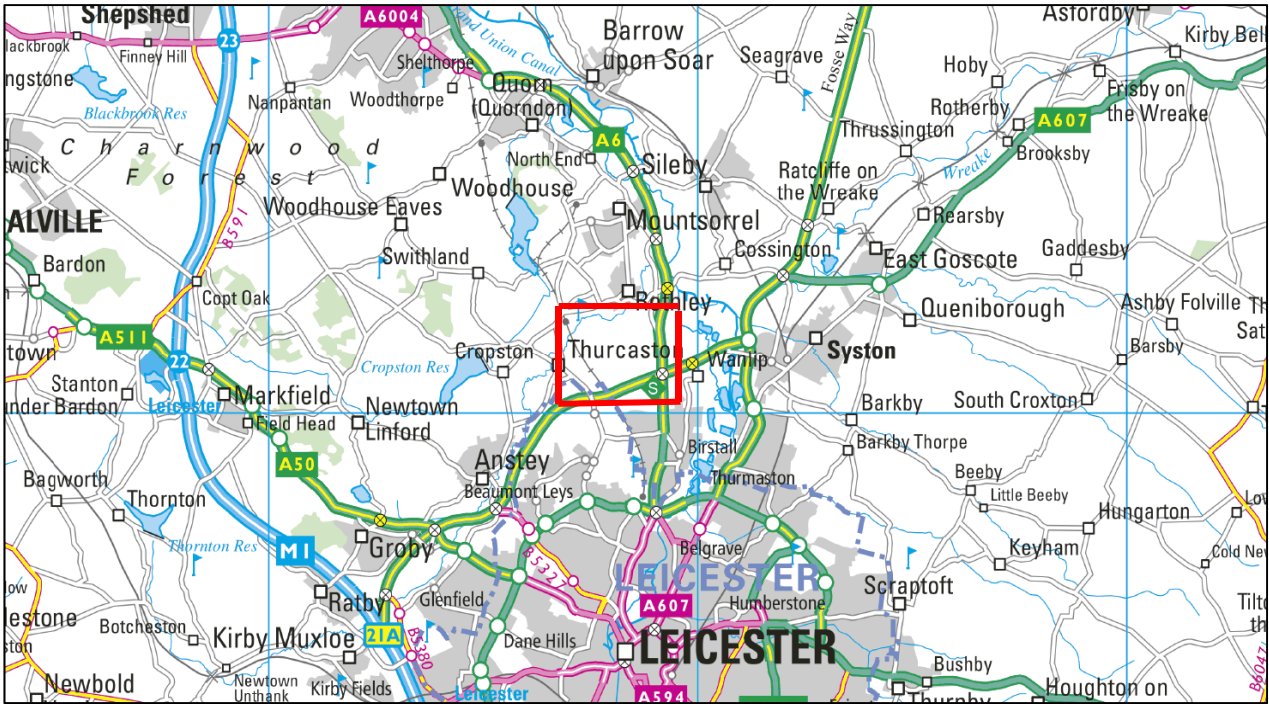

Figure 1: Site Location

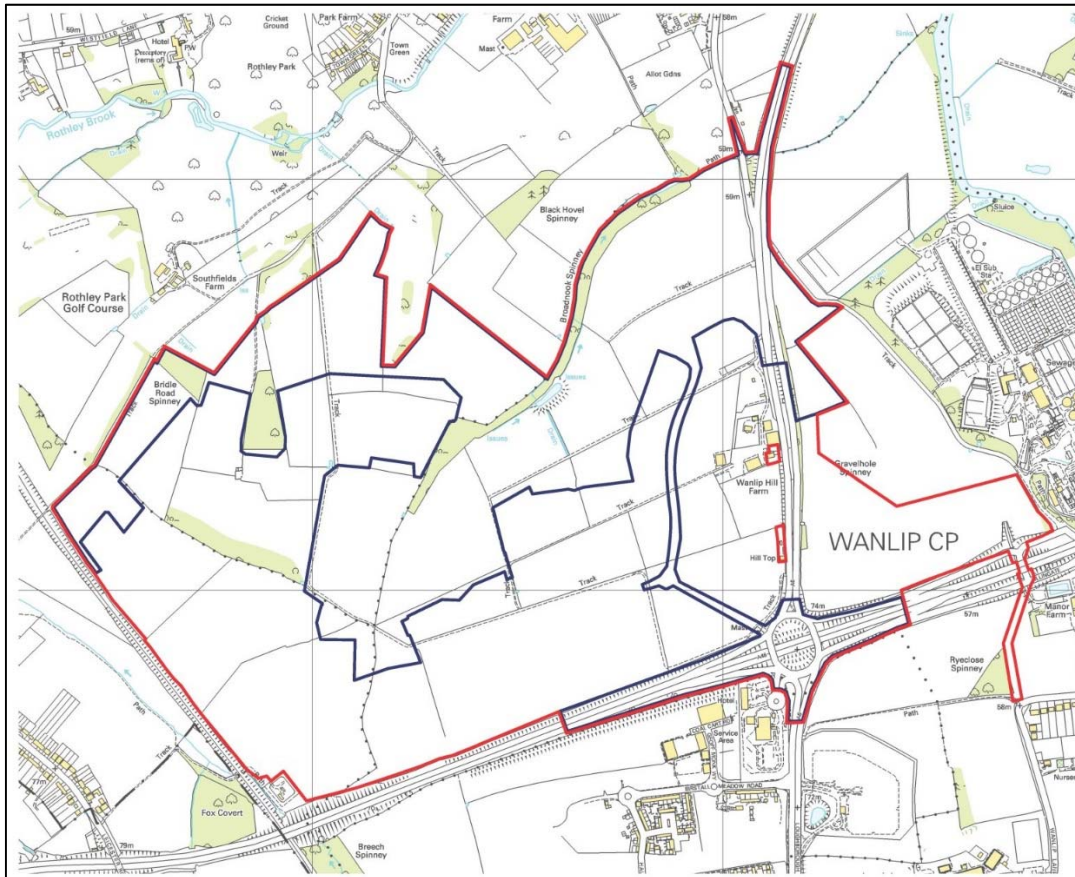

Figure 2: Location of site showing overall planning application boundary (red) and area subject to detailed proposals (blue)

Archaeological and Historical background

Previous work includes a heritage assessment, fieldwalking and geophysical survey. The assessment identified several known archaeological sites in the wider area dating from the Mesolithic period through to the Anglo-Saxon period and beyond. These include prehistoric flint scatters, Neolithic/ Bronze Age enclosures, Iron Age and Roman features suggesting settlement activity. Anglo-Saxon sunken buildings and an Anglo Saxon cemetery lie close to the edge of the study area and medieval earthworks are also identified nearby (Prospect Archaeology 2014).

Within the study area itself three main foci of archaeological activity have been previously identified (Fig. 3). These comprise a surface scatter of lithic material to the west, geophysical anomalies suggesting an enclosure associated settlement, likely to be of later prehistoric or Roman periods to the north and an Iron Age settlement to the east excavated in advance of the A46 Leicester western bypass (Beamish 1998).

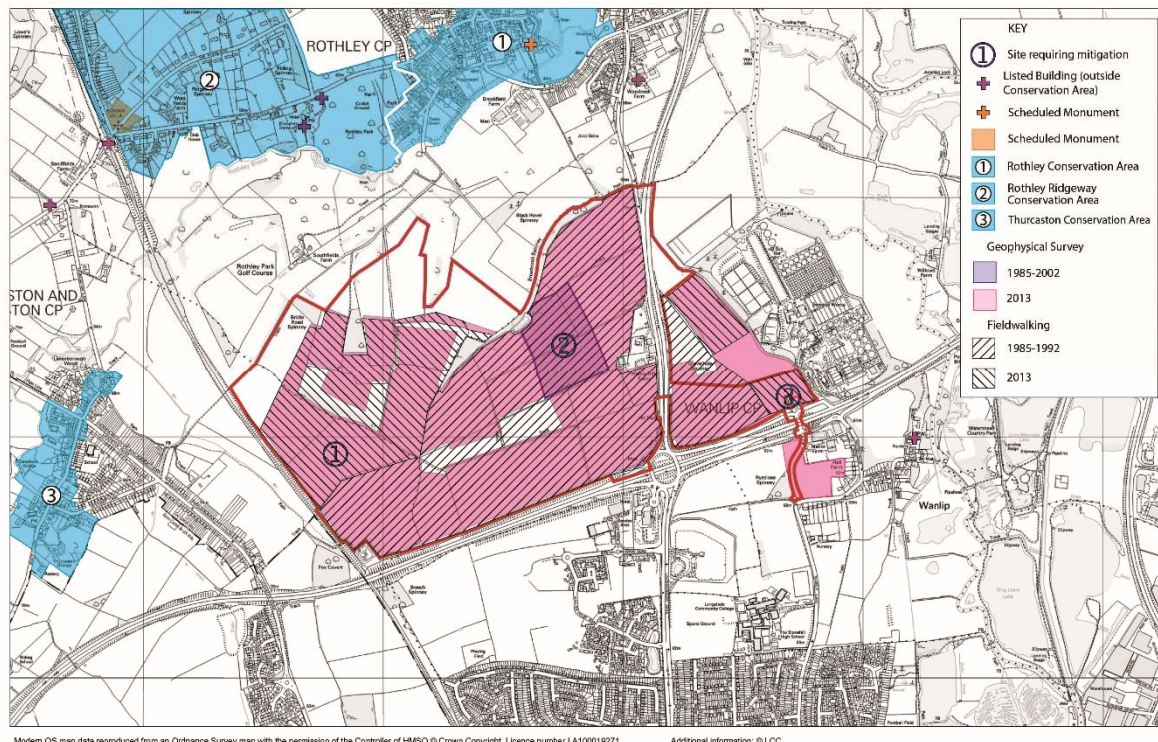

Figure 3: Previous archaeological work in the area.

In addition to known areas of interest a geophysical survey carried out across the site in 2013 identified a number of linear features possibly of archaeological origin in the study area (Phase Site Investigations, 2013, Fig. 4).

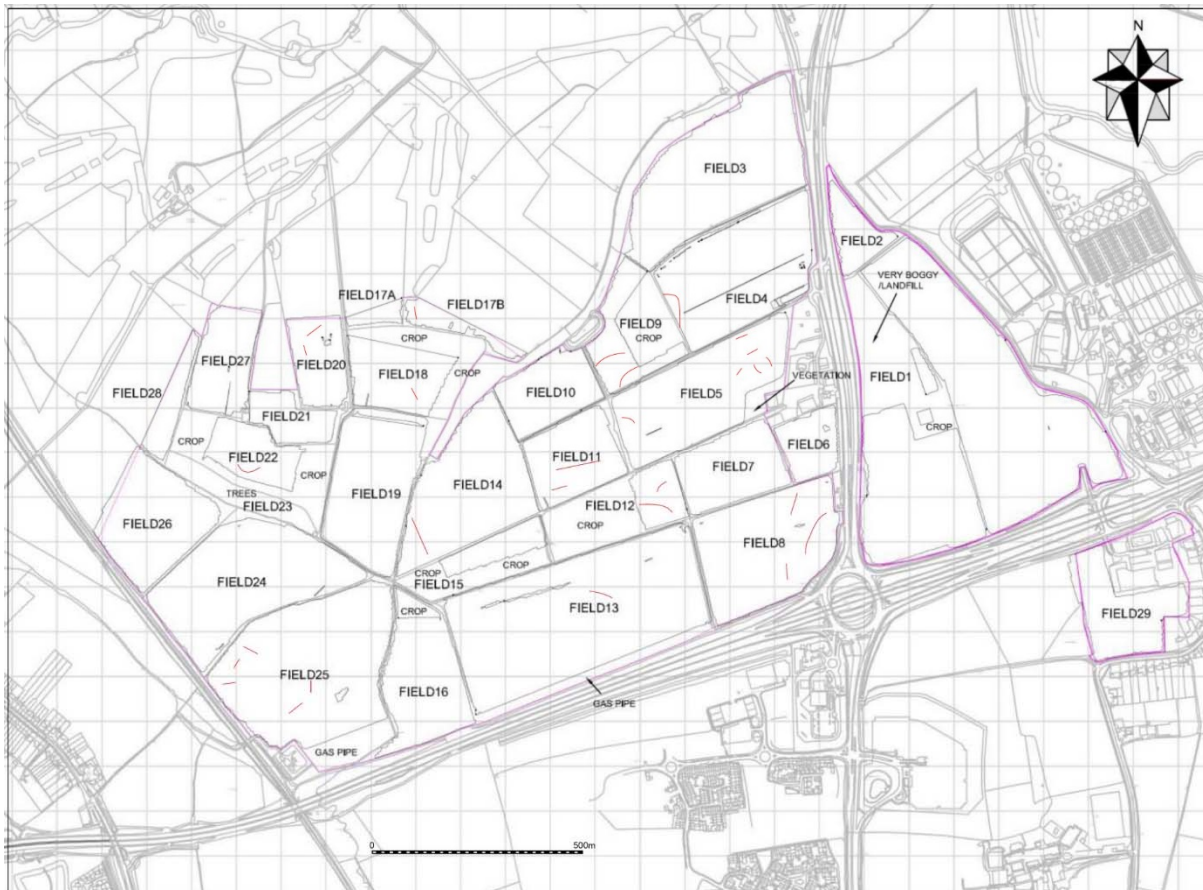

Figure 4: Plan of study area subject to geophysical survey with anomalies identified (red).
Taken from Phase Site Investigations, 2013

Archaeological Aims and Objectives

The main objectives of the archaeological work were as follows:

- To identify the presence/absence of any archaeological deposits.
- To establish the character, extent and date range for any archaeological deposits to be affected by the proposed ground works.
- To record any archaeological deposits to be affected by the ground works.
- To establish the relationship of any remains found to the surrounding contemporary landscape.
- To recover artefacts and ecofacts to compare with other assemblages and results
- To produce an archive and report of any results.

Within the stated project aims, the principal objective of the recording is to establish the nature, extent, date, depth, and significance of the heritage assets within their local and regional context in order to formulate a mitigation strategy to address the impacts of the proposed development on cultural heritage.

All work conforms to the requirements of the National Planning Policy Framework (2012). It has been designed in accordance with current best archaeological practice and the appropriate national standards and guidelines including:

- *Management of Archaeological Projects* (English Heritage, 1991);
- *Model Briefs and Specifications for Archaeological Assessments and Field Evaluations* (Association of County Archaeological Officers, 1994);
- *Code of Conduct* (Chartered Institute for Archaeologists, 2014);
- *Standard and Guidance for Archaeological Field Evaluations* (Chartered Institute for Archaeologists, 2014);
- *Standards for Field Archaeology in the East of England* (Association of Local Government Officers, 2003);

Methodology

A total of 48, 30m long and 2m wide trenches were excavated across the development area. The trenches focused on the proposed access roads into the site (initial groundworks), the areas of known archaeological activity (flint scatter and enclosures) and areas containing anomalies possibly associated with archaeological remains identified on the geophysical survey. Trench locations are shown on Fig. 5.

A 13 ton 360 mechanical excavator was used to excavate the trenches using a 2m wide toothless ditching bucket. Topsoil and subsoil was stored separately and excavation ceased at undisturbed natural deposits.

The trenches were recorded at an appropriate scale by measured drawing and photography and were GPS-located to Ordnance Survey National Grid.

A photographic record, utilising high resolution digital data capture, was maintained during the course of the fieldwork and included:

- the site prior to commencement of fieldwork;
- the site during work, showing specific stages of fieldwork;
-

Upon completion of the evaluation trenching, the excavated trenches were backfilled and well compacted.

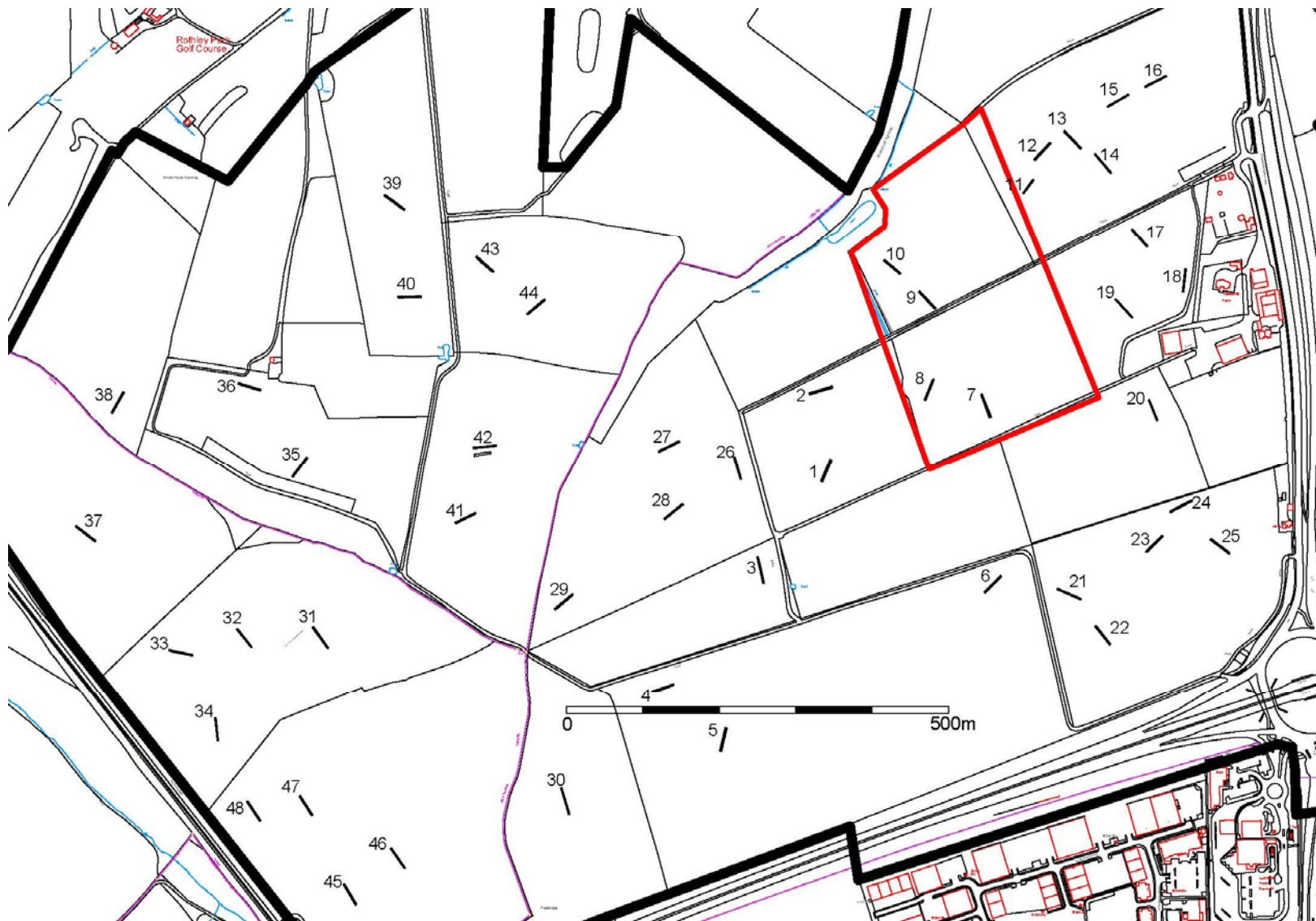

Figure 5: Trench locations

Results

The 48 trenches were excavated across the area of proposed development consecutively (Figs 6-11). The topsoil, subsoil and natural substrata varied across site. Archaeological features were encountered in 7 of the 48 trenches (Fig. 12). These were trenches 3, 4, 8, 9, 10, 41, and 44.

All trenches measured 2m in width and 30m in length and all measurements were taken from the top of the trench. The following table lists all the trenches.

Table 1: Trench Descriptions

Trench No.	Orientation	Min. Depth	Max. Depth	Description
1	NE-SW	0.36m	0.50m	Negative trench, evidence of furrows
2	E-W	0.44m	0.60m	Negative trench
3	N-S	0.25m	0.48m	Undated posthole [19], evidence of furrows
4	E-W	0.43m	0.66m	2 undated linear features excavated [1] [6] and pit containing burnt stone excavated [15]
5	N-S	0.39m	0.54m	Negative trench, evidence slate field drain
6	NE-SW	0.23m	0.63m	Negative trench, evidence of furrow
7	SE-NW	0.33m	0.46m	Negative trench, evidence of slate field drains
8	NE-SW	0.43m	0.65m	Posthole containing pottery [16] and evidence of furrows
9	SE-NW	0.30m	0.42m	3 linear features with pottery excavated [21] [24] [31], evidence of furrows
10	SE-NW	0.16m	0.38m	2 linear features excavated [25] [33], evidence of furrows
11	NE-SW	0.38m	0.65m	Negative trench, evidence of slate field drain
12	NE-SW	0.31m	0.58m	Negative trench, evidence of field drain
13	NW-SE	0.23m	0.42m	Negative trench
14	NW-SE	0.30m	0.43m	Negative trench, evidence of field drain
15	SW-NE	0.26m	0.42m	Negative trench
16	SW-NE	0.25m	0.38m	Negative trench, evidence of furrow
17	NW-SE	0.23m	0.33m	Negative trench
18	N-S	0.25m	0.45m	Negative trench, evidence of furrows and field drains
19	NW-SE	0.23m	0.30m	Negative trench, evidence of field drains
20	N-S	0.25m	0.34m	Negative trench, evidence of furrow and field drain
21	NW-SE	0.36m	0.48m	Negative trench, evidence of furrows
22	NW-SE	0.35m	0.41m	Negative trench, evidence of furrows
23	SW-NE	0.25m	0.43m	Negative trench, evidence of furrows
24	SW-NE	0.29m	0.40m	Negative trench

25	NW-SE	0.50m	0.88m	Negative trench, some evidence of colluvium deposits
26	N-S	0.24m	0.36m	Negative trench, evidence of furrows
27	NE-SW	0.23m	0.42m	Negative trench, evidence of gravel field drains
28	SW-NE	0.17m	0.46m	Negative trench
29	SW-NE	0.26m	0.40m	Negative trench
30	NW-SE	0.32m	0.44m	Negative trench, evidence of furrows
31	SE-NW	0.30m	0.40m	Negative trench, evidence of furrows
32	NW-SE	0.38m	0.55m	Negative trench, evidence of furrow and field drain
33	E-W	0.36m	0.60m	Negative trench, evidence of field drains
34	N-S	0.50m	1.26m	Negative trench, evidence of land drain and colluvium deposits
35	SW-NE	0.28m	0.38m	Negative trench
36	E-W	0.56m	0.85m	Negative trench, evidence of furrows and field drains
37	NW-SE	0.42m	0.54m	Negative trench, evidence of field drain
38	NE-SW	0.31m	0.42m	Negative trench, evidence of field drain
39	SE-NW	0.63m	1.15m	Negative trench, evidence of colluvium
40	E-W	0.38m	0.53m	Negative trench
41	SW-NE	0.30m	0.48m	1 linear feature excavated [8], evidence of furrows and field drains
42	E-W	0.29m	0.50m	Negative trench, evidence of slate field drain
43	NW-SE	0.28m	0.38m	Negative trench
44	SW-NE	0.27m	0.40m	2 undated postholes [11] [13]
45	NW-SE	0.28m	0.70m	Negative trench, evidence of field drain
46	NW-SE	0.33m	0.49m	Negative trench
47	NW-SE	0.23m	0.37m	Negative trench
48	NW-SE	0.22m	0.38m	Negative trench



Figure 6: Trenches 1, 2,5,6,7,11,12,13 and 14



Figure 7: Trenches 15-23



Figure 8: Trenches 24-32



Figure 9: Trenches 33-40 and 42



Figure 10: Trench 43



Figure 11: Trenches 45-48

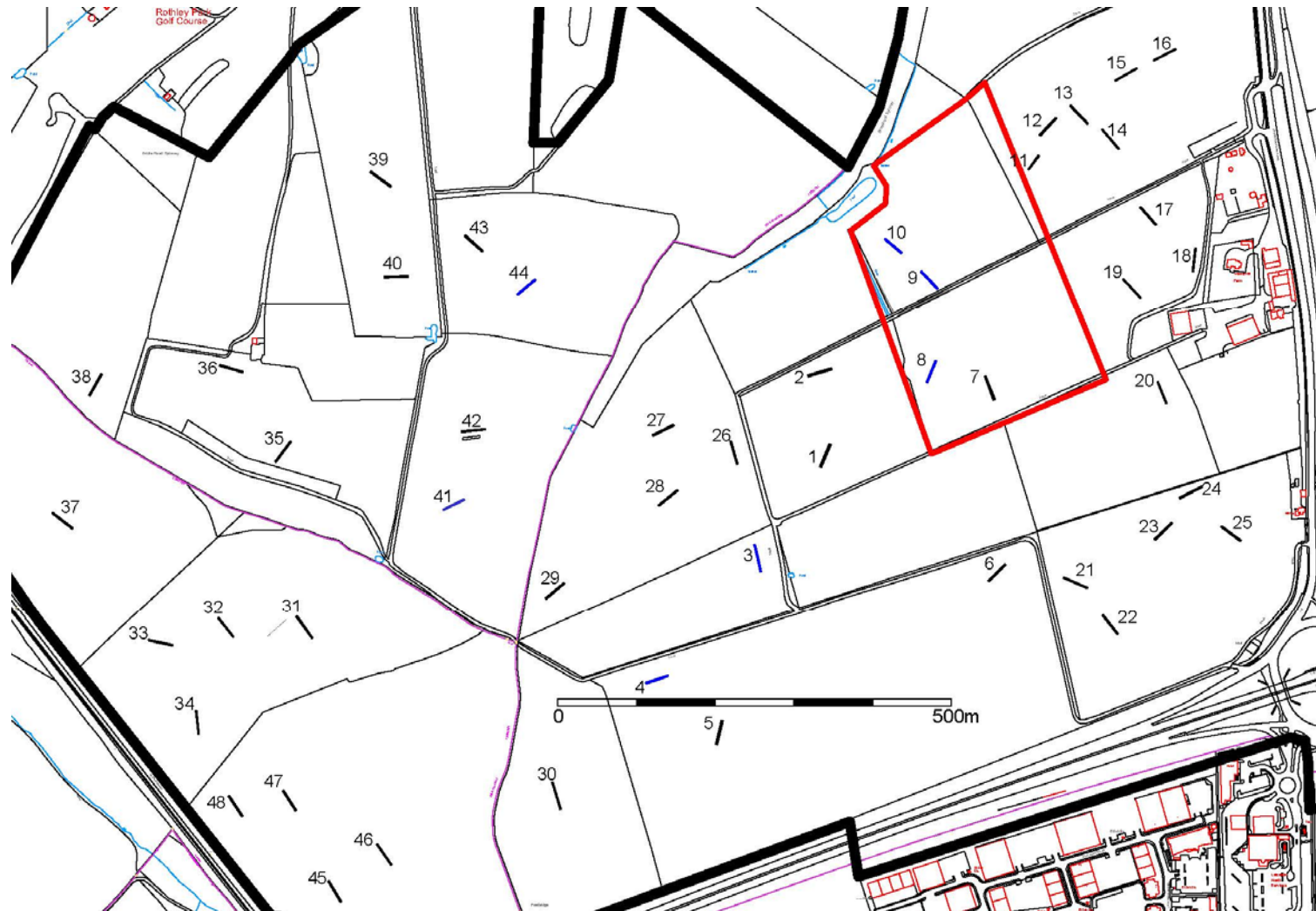

Figure 12: Plan of trenches. Blank trenches are shown in black and trenches containing archaeology are shown in blue

Trench 3

This trench contained a single posthole feature [19], not recorded by the geophysical survey. The cut was sub-oval in plan and measured 0.46m in width and 0.58m in length at a depth of 0.16m (Figs 13 and 14). The sides were moderately sloping to a concave smooth base. It contained a single fill (20) consisting of a mid-brown sandy-clay soil with occasional chalk and grit inclusions. Some fist sized packing stones were also recorded. No finds were recovered from this feature, although an Early Bronze Age barbed and tanged arrowhead was recovered from the topsoil, during machining.



Figure 13: Trench 3 looking north



Figure 14: Posthole [19] looking east (0.5m scale)

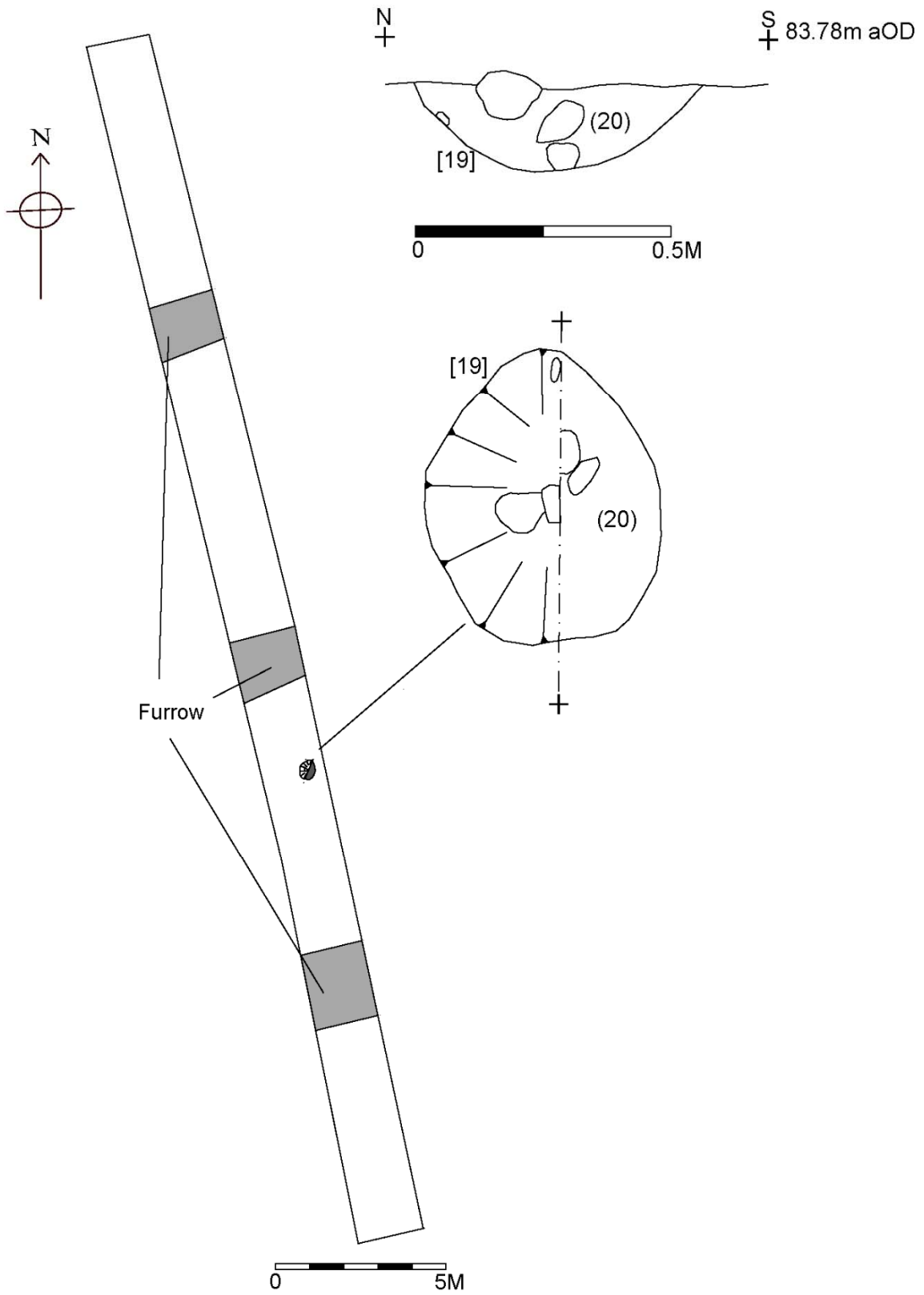

Figure 15: Trench 3 plans and sections

Trench 4

Three archaeological features were recorded in this trench (Figs 16 and 19). At 10m from the west end of the trench a small gully was observed [1] running north-south, consisting of steep cut measuring 0.43m in width and 0.30m in depth (Figs 17 and 19). The feature appeared to terminate within the trench, heading out of the trench to the north. Its lower fill (2) consisted of a mid-dark orange-brown silty clay of soft compaction containing occasional charcoal flecks. Overlaying this was a dark blackish-grey silty clay (3) of friable compaction containing common charcoal flecks and rare small pebble inclusions. No finds were recovered from (2) or (3).



Figure 16: Trench 4 looking north east (1m scale)

At approximately 6m from the west end of the trench a further linear was recorded running north-south (Fig. 17). It consisted of a 'V' shaped cut [6] measuring 0.80m in width and 0.45m in depth. It contained a single fill (7) consisting of a mid-brownish grey silty-clay with occasional charcoal flecks and small angular-rounded pebble inclusions. Two flint flakes were recovered and environmental samples show the presence of cereal grain, wheat glume bases and 3 large grass seeds.

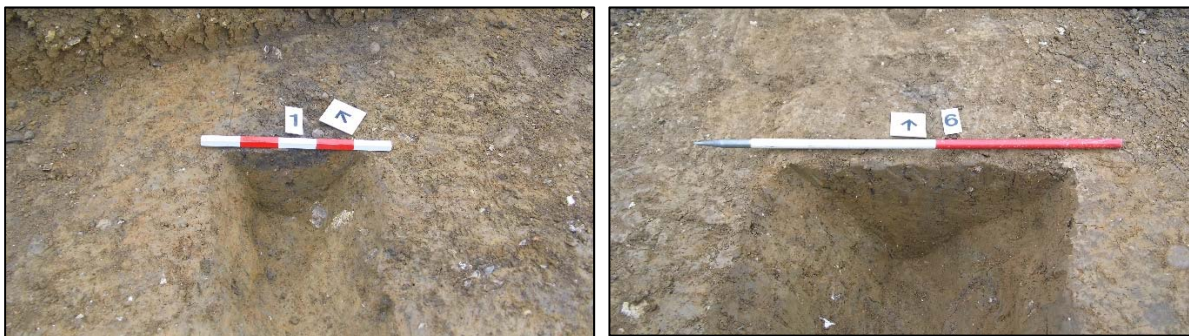

Figure 17: Gully [1] and linear [6] looking north (0.5m and 1m scales)

At approximately 15m from the west end of the trench a possible pit/linear was recorded [15]. It measured 2.2m in width and up to 0.2m in depth (Fig. 18). It appeared to be a shallow cut with shallow sloping sides and irregular base. The fill (18) consisted of predominantly heat cracked stone cobbles of varying size, with a greyish-orange clay matrix and common charcoal fleck inclusions. All cobbles within the pit showed signs of burning with some heavily degraded due to probable repeated heating. The surrounding substrata showed no signs of scorching suggesting the cobbles were heated elsewhere then deposited in this shallow pit after use. No finds were recovered from this feature.



Figure 18: Pit/linear [15] with fire cracked stones (top) and with fire cracked stones removed (bottom) looking south (1m scale)

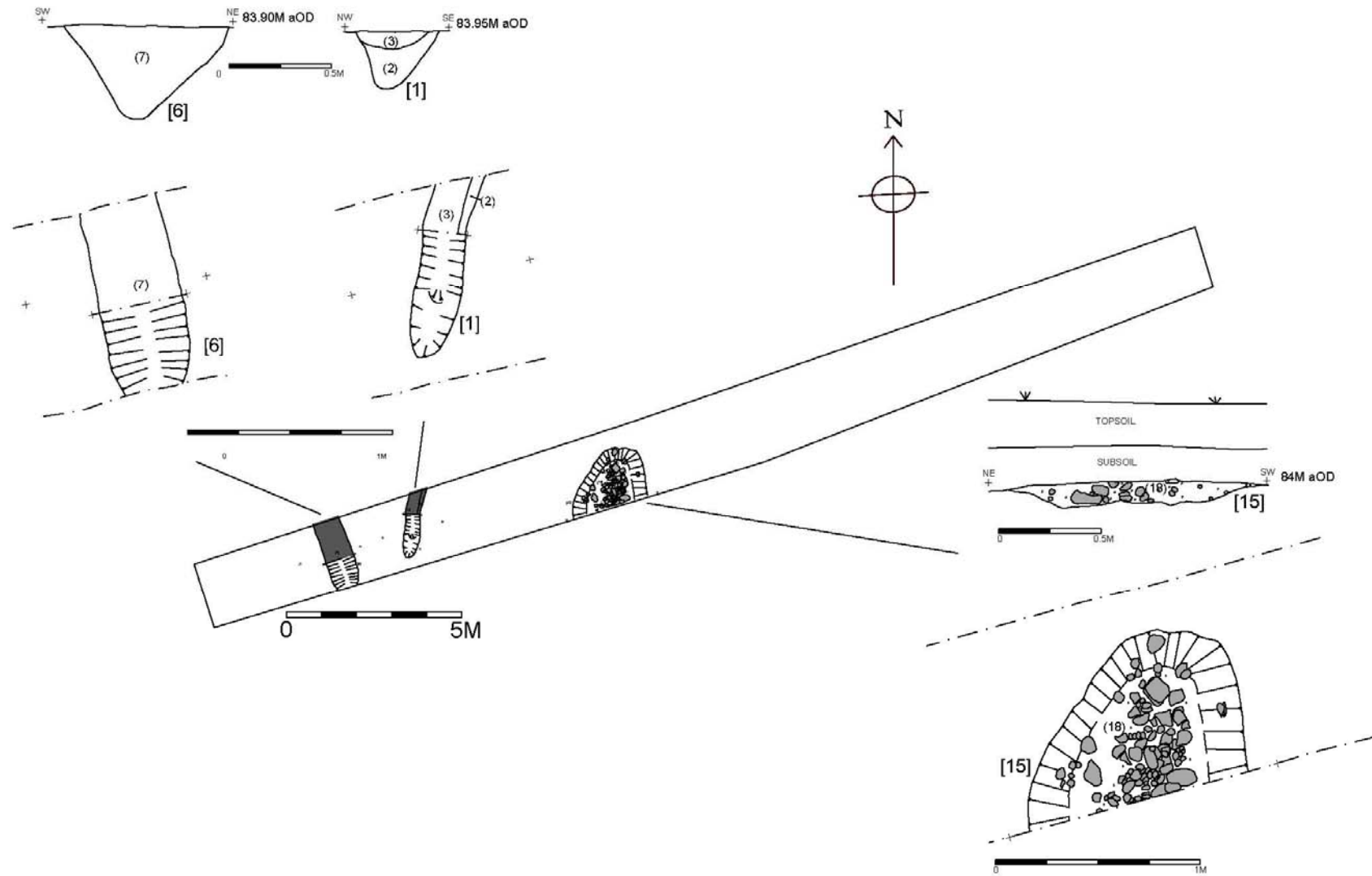

Figure 19: Trench 4 plans and sections

Trench 8

A single posthole [16] was recorded in this trench (Fig. 20). It measured 0.42m in length, 0.34m in width and was 0.65m in depth. It consisted of steep concave sides with a smooth concave base and contained a single fill (17) comprising a friable dark brown-grey silty clay with occasional charcoal flecks and small pebble inclusions (Figs 21 and 22). Seven sherds of pottery were recovered from this feature dating to the Middle-Late Iron Age.



Figure 20: Trench 8 looking south west (1m scale)



Figure 21: Posthole [16] looking south east (0.30m scale)

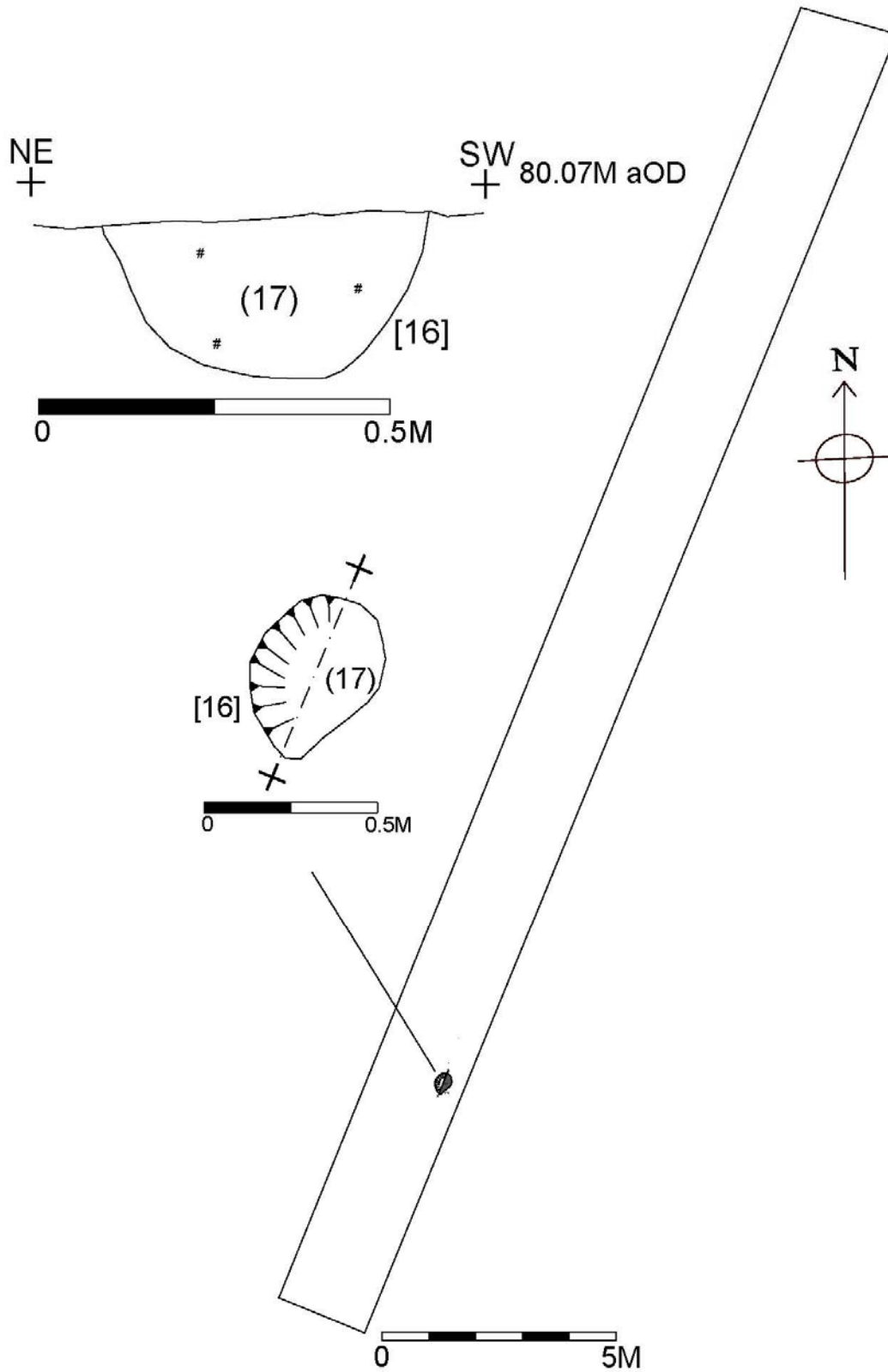

Figure 22: Trench 8 plans and sections

Trench 9

Several trenches were located to test the geophysical anomalies. These appeared to show linear features suggesting probable evidence for settlement within the north-east of the development area thought to be an Iron Age enclosure.

Trench 9 was located over probable archaeological deposits as highlighted on the geophysical survey (Figs 23 and 24).

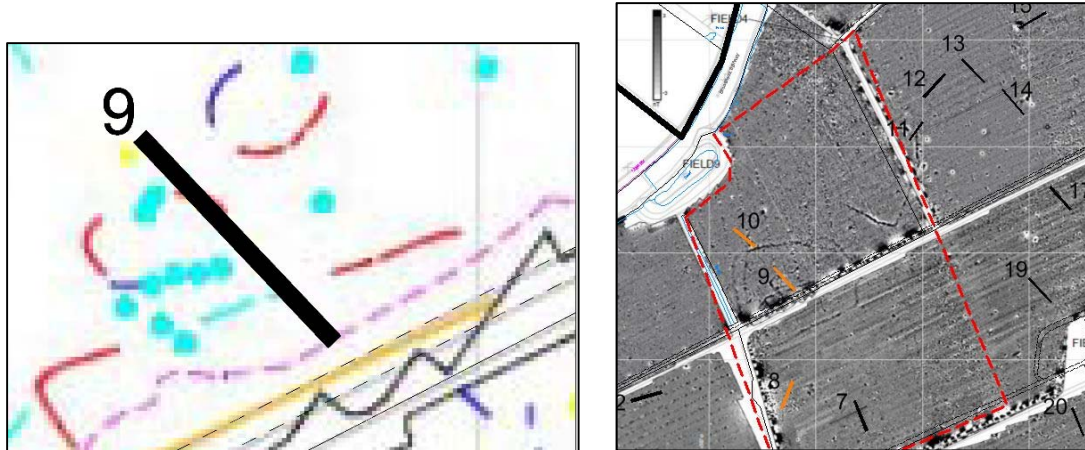

Figure 23: Location of trench 9 on geophysical survey data of area.



Figure 24: Trench 9 looking north-west (1m scale)

At the south-east end of the trench a slightly curving gully [21] was observed running south-east to north-west across the trench (Fig. 25 and 27). It consisted of a steep concave cut with concave smooth base and measured 0.6m in width and 0.31m in depth. Its primary fill (23) consisted of a plastic light brown-orange coarse sandy-clay with frequent stone and pebble inclusions. No finds were recovered from this fill. Overlaying this was a friable dark orangey-

brown sandy clay with occasional rounded pebbles and cobbles ((22) = (26)). Eighteen sherds of pot were recovered from this fill dating to the Middle-Late Iron Age and seven fragments of animal bone were also recovered. Flint debitage and heat cracked stone was also present in the fill. This feature appeared to confirm a linear anomaly seen on the geophysical survey.

Immediately to the north west of [21] a second linear [24] was observed running north-east to south-west across the trench (Fig. 24). It consisted of a steep concave cut with a flat base measuring 0.9m in width and 0.36m in depth. It contained a single fill (4) consisting of a dark orangey-brown sandy clay with a moderate amount of pebbles and larger angular stone inclusions. Five sherds of pottery were recovered dating from the Middle-Late Iron Age along with 10 fragments of animal bone. Flint debitage and heat cracked stone was also present.

No relationship could be seen between gully [21] and linear [24].



Figure 25: Gully [21] looking north-west (1m and 0.5m scale) and linear [24] looking north-east (1m and 0.5m scale)

A third ditch was observed at the north-west end of the trench curving from the south-east to north-west [31] (Fig. 26). It consisted of a convex steep cut with a smooth base measuring 1m in width and 0.6m in depth. Its lower fill (32) consisted of friable a mid-orange-brown sandy

clay with frequent natural stone fragments. A single sheep/goat metatarsal was recovered from the fill along with a flint scraper fragment and frequent heat cracked stones were also present. Overlaying this a friable dark orangey brown sandy-clay fill was present (5) containing frequent natural stone inclusions. Fourteen sherds of Middle-Late Iron Age pottery were recovered from the fill along with 17 fragments of animal bone. Heat cracked stones were recorded.



Figure 26: Ditch [31] looking north-west (1m and 0.5m scale)

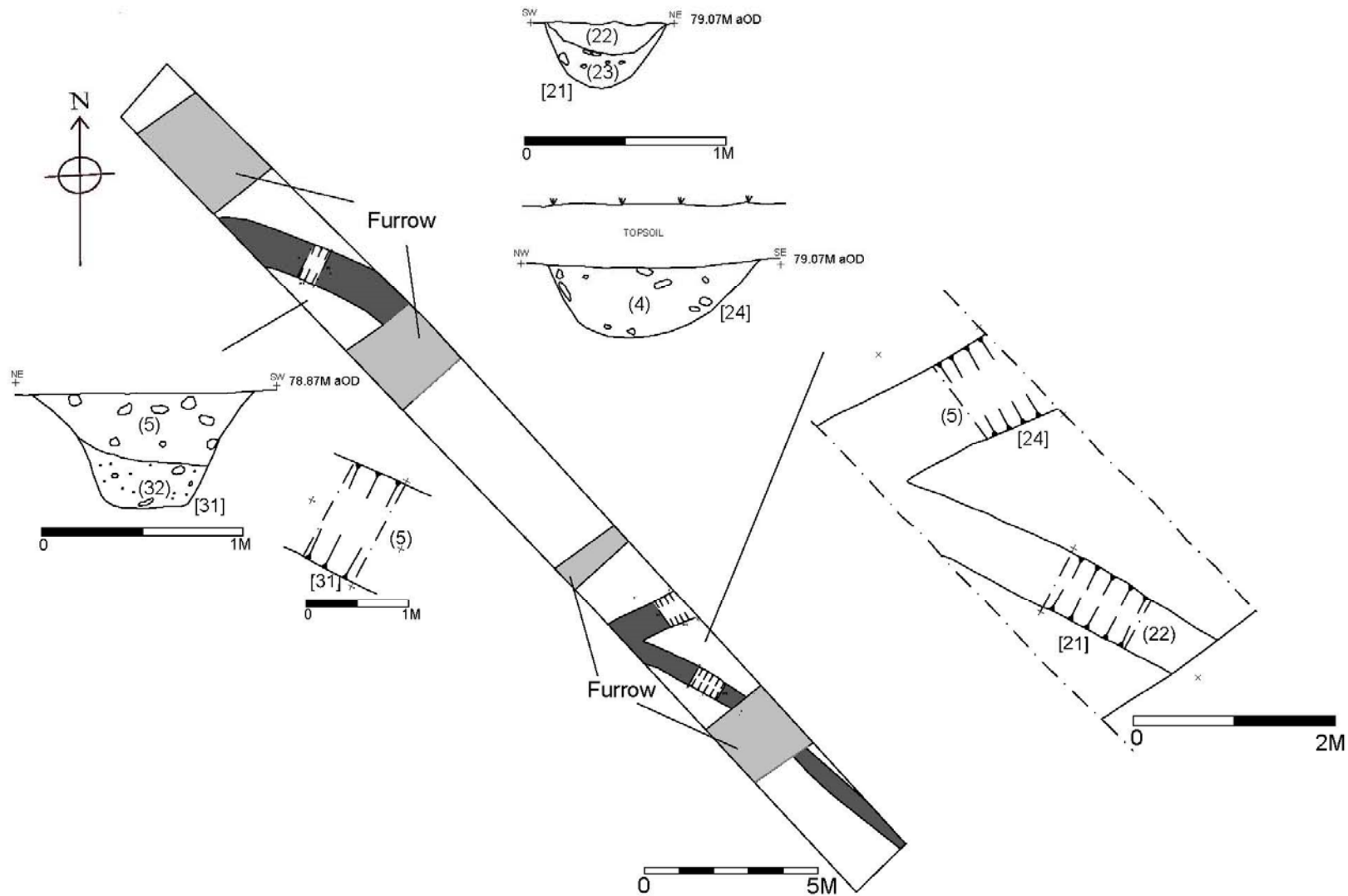

Figure 27: Trench 9 plans and sections

Trench 10

Trench 10 was located over probable archaeological features identified on the geophysical survey (Figs 28 and 29) to the north-west of trench 9 in the north-east of the development area.

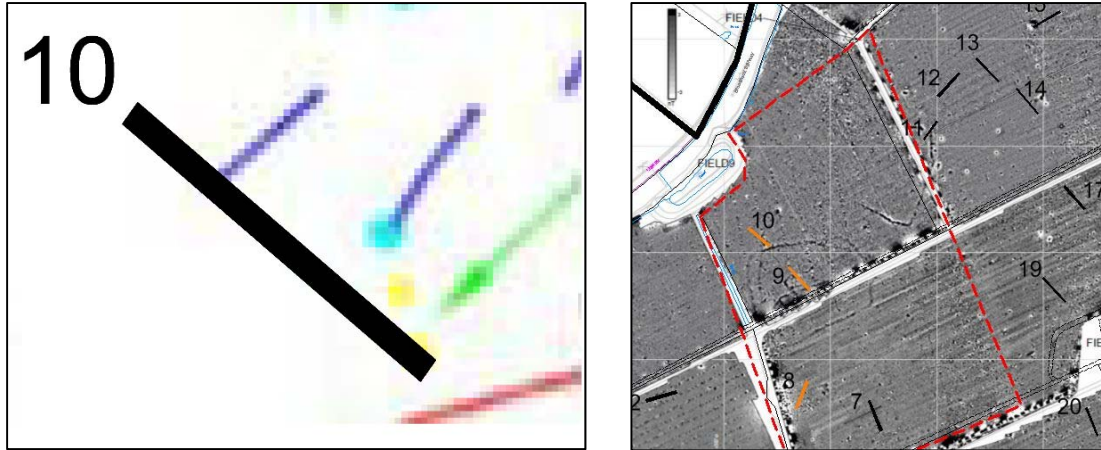

Figure 28: Location of trench 10 (left) and geophysical survey data of area (right)



Figure 29: Trench 10 looking north-west (1m scale)

A large ditch was observed towards the south-east of the trench running north-south across the trench (Figs 29 and 30). The ditch consisted of a predominantly concave shaped moderately sloping cut with a smooth flat base, measuring 2.3m in width and 0.74m in depth [25]. Its eastern edge appeared truncated by a modern gravel field drain. The primary fill (27) consisted of a firm mid-yellowish brown silty clay with abundant natural flint, pebbles and chalk fleck inclusions representing silting at the base of the ditch cut. No finds were recovered from this fill.

Overlaying this was a mid-dark greyish brown silty clay with occasional small pebbles and some charcoal inclusions (28). Six fragments of animal bone and a flint core were recovered from this fill. Overlaying this a mid-brownish grey silty clay was observed (29) containing small angular-rounded pebbles and natural flints with occasional charcoal inclusions. This fill appeared sterile with no finds recovered. The uppermost fill recorded (30) consisted of a firm mid-dark brownish grey silty clay with common small angular-rounded pebbles and natural flints. Occasional charcoal fleck inclusions were also observed. Five fragments of animal bone, a flint core and flint debitage were recovered from this fill.

At the north-west end of the trench a gully was observed running north-east to south-west across the trench [33] (Figs 30 and 31). It consisted of a moderately sloping concave cut with a smooth base measuring 0.70 in width and 0.30m in depth. It contained a single fill (34) consisting of a mid-dark greyish brown silty clay with common rounded cobbles and rare charcoal inclusions. No finds were recovered from this fill.



Figure 30: Ditch [25] looking north (2m scale) and gully [33] looking north-east (1m scale)

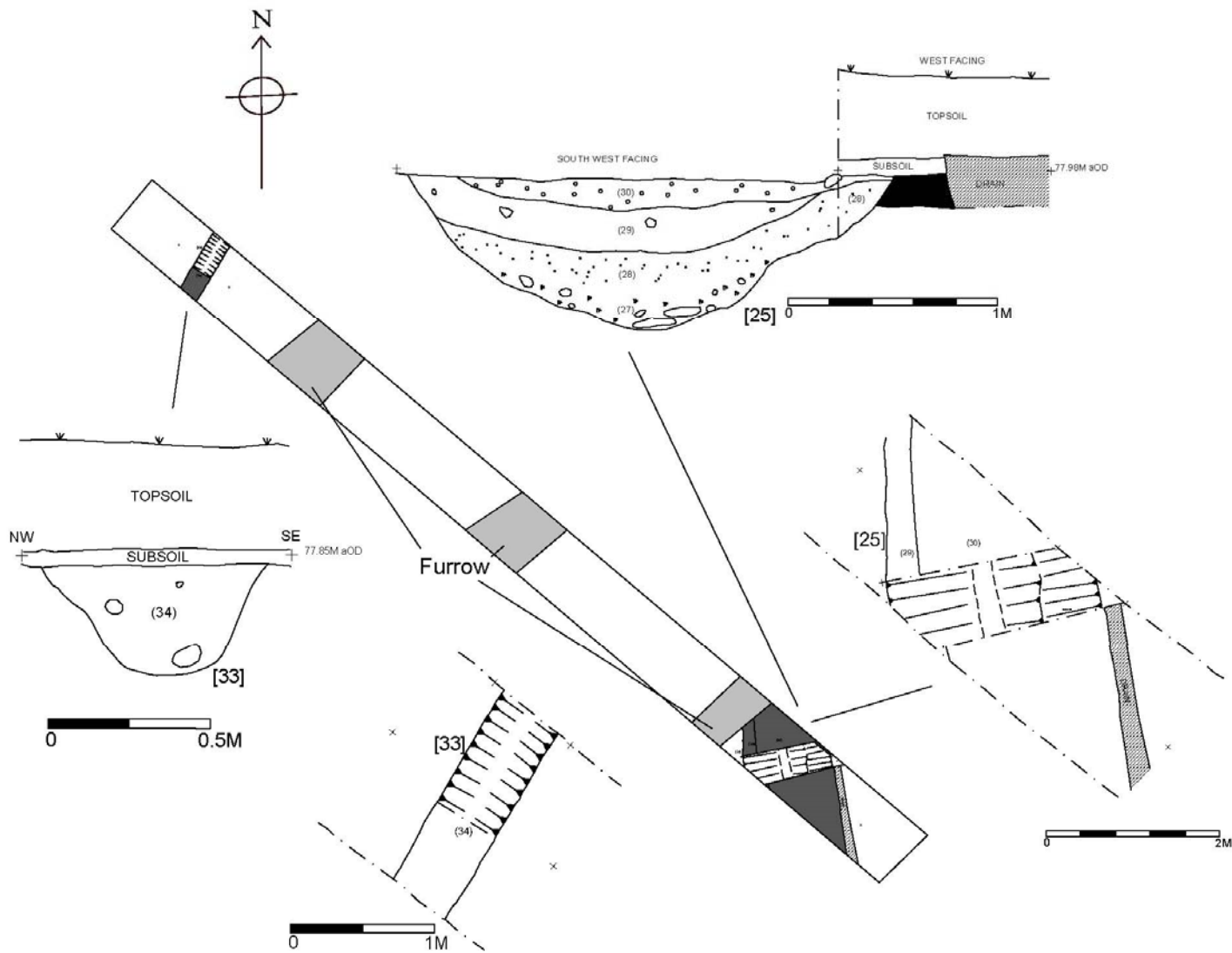

Figure 31: Trench 10 plans and sections

Trench 41

A single feature was identified at the south-west end of trench 41, perhaps representing the terminus of a ditch or part of a large pit (Fig. 32). It consisted of a straight sided moderately steep cut [8] with a smooth concave base measuring 1.43m in width and 0.52m in depth (Figs 33 and 34). Its primary fill (9) consisted of a plastic mid greyish brown silty clay with rare charcoal inclusions, representing initial silting of the feature. No finds were recovered from this fill. Overlain this was a mid-dark brownish grey silty clay containing occasional charcoal flecks and occasional small-medium sized sub angular pebble inclusions (10). No finds were recovered from this fill.



Figure 32: Trench 41 looking north-east (1m scale)



Figure 33: [8] looking south (1m scale)

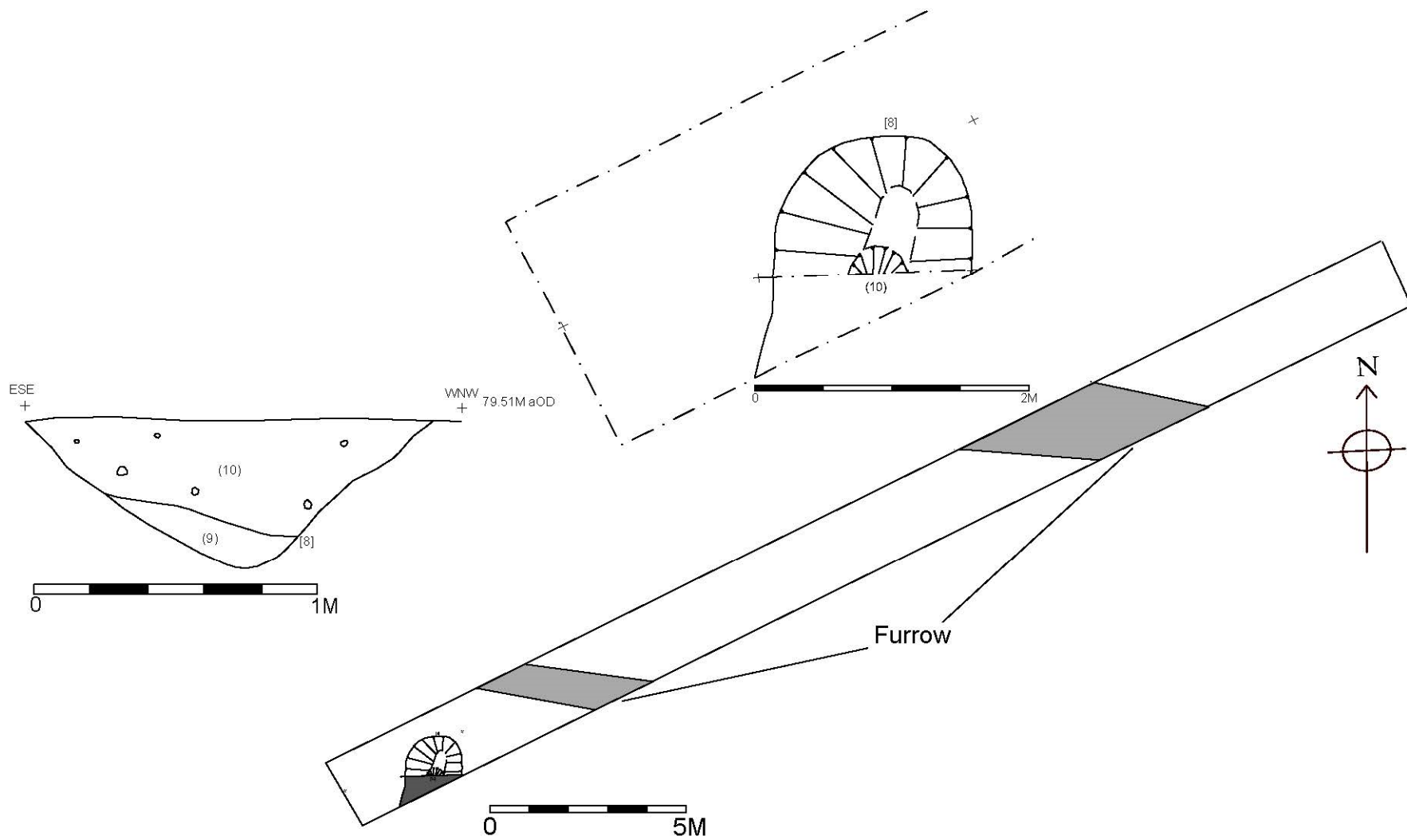

Figure 34: Trench 41 plans and sections

Trench 44

Two features were observed in trench 44 (Fig. 35). The first was a posthole of circular shape, measuring 0.32m in diameter and 0.13m in depth consisting of a shallow concave cut with a smooth concave base [11]. It contained a single fill (12) consisting of a friable mid brownish grey silty clay with occasional charcoal fleck inclusions (Figs 36 and 37). No finds were recovered.



Figure 35: Trench 44 looking north-east (1m scale)

A further posthole was observed at the south-west end of the trench [13]. It measured 0.58m in width and 0.23m in depth, consisting of a moderately sloping concave cut with a smooth concave base. It contained a single fill (14) of abundant burnt and degraded stone pebbles, with a dark greyish brown silty clay matrix. Common charcoal flecks were also recorded (Figure 35 and 36). No finds were recovered.



Figure 36: Posthole [11] looking south-west and posthole [13] looking south (0.3m scale)

Middle-Late Iron Age Pottery

Nicholas J. Cooper

Introduction

A total of 44 sherds of Middle-Late Iron Age and pottery weighing 257g, and with an average sherd weight of 6g, were recovered from five stratified contexts (4), (5), (17), (22) and (26). The pottery is generally in good condition, with some sherds abraded, and derives from the fills of ditches [24] and [31], gully [22] and posthole [16] in Trenches 8 and 9.

Methodology

The Iron Age pottery was classified using the Leicestershire Prehistoric pottery form and fabric series using low power microscopy (Marsden 2011, 61) and quantified by sherd count, weight (g) and EVEs (although no measurable rims were recovered). The assemblage has been analysed in accordance with *The Standard for Pottery Studies in Archaeology* (Barclay *et al.* 2016).

Results

The full quantified record of the pottery is presented in Table 2. The assemblage belongs to the East Midlands scored ware tradition of the Middle to Late Iron Age spanning the 3rd century BC to the mid-1st century AD (Elsdon 1992a) and comprises body sherds and a single rim fragment from jars of various sizes, a proportion of which bear the distinctive scored decoration (Figure 37).

Table 2: M-L Iron Age pottery

Trench	Cont	Cut	Fabric	Form	Part	Decor	Sherds	Wght
9	4	24	R1	Elsdon 2-4	body	scored x 1	4	55
9	4	24	R1 fine	Elsdon 6	body	smoothed	1	2
9	5	31	R1	Elsdon 2-4	body	scored x 2	14	105
8	17	16	R1	Elsdon 2-4	body	undec	7	25
9	22	21	R1	Elsdon 2	rim x1	fingertip	5	25
9	22	21	Q1	misc	body	undec	11	15
?	26	?	R1	Elsdon 2-4	body	scored x 1	2	30
Total							44	257

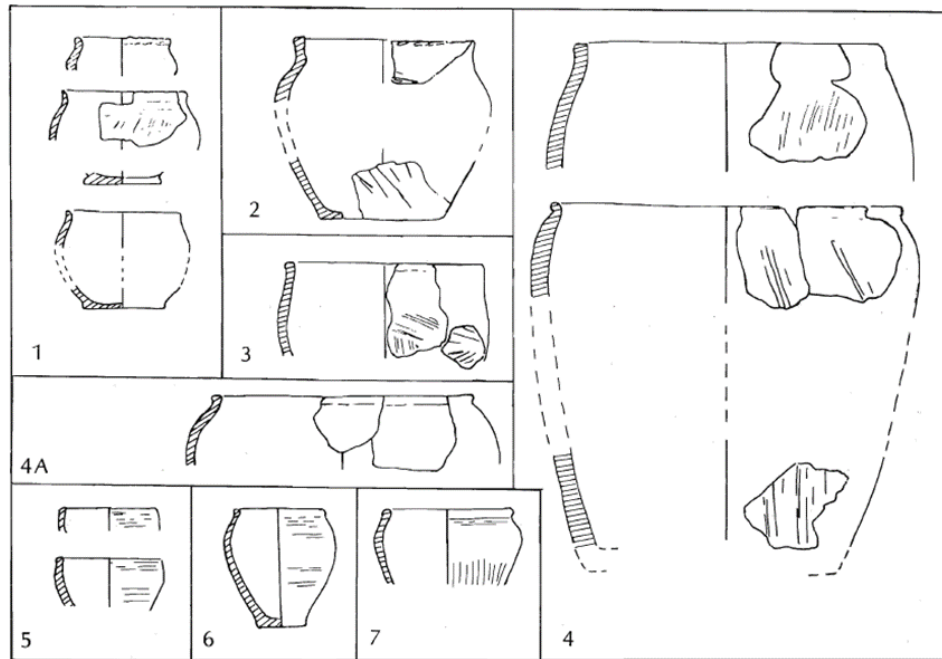

Figure 38: Typology of vessel forms from Grove Farm, Enderby (Elsdon 1992b, illus 24)

Discussion and potential

The sherds belong mainly to jars of medium to large size (Elsdon 1992b Types 2-4) with one rim with fingertip decoration belonging to Type 2 medium jar. One sherd in a finer fabric with a smooth reduced black surface may belong to a jar of Type 6. The vessels are predominantly manufactured with opening materials of local igneous origin (with or without additional sand content in the clay). The majority is tempered with granodiorite from Mountsorrel in the Charnwood district of north-west Leicestershire (Fabrics R1 and R2) (recognised chiefly by the occurrence of large plates of biotite mica) (Knight *et al.* 2003).

One third of the assemblage is tempered with quartz sand (Fabric Q1), which again is typical for sites in the area.

Though small, the present assemblage also demonstrates the survival of well-stratified and dateable ceramics across the site that will inform the chronological, economic and social understanding of the Iron Age occupation when further work is undertaken.

Animal Bone

William Johnson

Introduction

A small animal bone assemblage (47 fragments) was collected by hand during an evaluative excavation at the site. Animal bones were recovered from seven contexts, six of which were ditch fills and one was a gully fill. All of the contexts were dated to the Middle to Late Iron Age.

Method

The bones were identified by comparison to reference material held at the University of Leicester and recorded in a catalogue (Table 3). Condition was scored using Harland et al.'s (2003) scale.

Results

The condition of the bones was described as 'good' across the majority of contexts with only the bones from context 22 described as 'fair'. No apparent signs of weathering, root etching or gnawing were noted on any of the bones. Fragmentation level was fairly high although it was possible to reassemble many fragments from (5), (22) and (30). Most of the fragmentation was identified as modern damage.

Many of the bones could be identified to species. The majority of the identifiable bones belonged to cattle. Cattle bones were represented in all contexts except (32) covering a range of elements (see table). Other species represented included sheep/goat from (22), (28) and (32) all of which were long bones and a fragment of pig maxilla was recovered from (22).

Butchery was only noted on the cattle axis from (5) comprising 5 parallel cut marks on the lateral side of the vertebra body. No pathologies were identified on the bones.

Discussion

The bones are most likely the result of food waste including cattle, sheep/goat and pig. This conclusion is supported by the presence of butchery marks. A wide range of elements are present potentially representing the processing of complete animals on site.

Statement of Potential

No further work is required on the assemblage under study. Should further excavation work be carried out at the site analysis of the bone is recommended as the bone is well preserved with complete elements being present and fragmentation levels are not high in comparison to other Iron Age assemblages with much of the damage the result of modern breakages. It should be possible to reveal animal husbandry strategies and diet in greater detail should a larger assemblage from the site be available for study in the future. In addition sampling would allow for the recovery of smaller fauna allowing a more detailed investigation of the nature of animal exploitation at the site.

Table 3: Catalogue of hand collected animal bone presented by specimen

Context	Cut	Feature	Date	Element	Taxon	Fragments	Comment
4	24	Ditch fill	M-LIA	Scapula	Large mammal	3	Fragment of blade
4	24	Ditch fill	M-LIA	Femur	Cattle	1	Shaft fragment
4	24	Ditch fill	M-LIA	Tibia	Medium mammal	1	Shaft fragment
4	24	Ditch fill	M-LIA	Long bone	Medium mammal	4	Shaft fragments
4	24	Ditch fill	M-LIA	Indet.	Medium mammal	1	Fragment
5	31	Ditch fill	M-LIA	Axis	Cattle	4	Body, centrum plate fused, cut marks
5	31	Ditch fill	M-LIA	Vertebra	Large mammal	1	Fragment
5	31	Ditch fill	M-LIA	Tibia	Cattle	7	Fused, both ends present, modern breakages
5	31	Ditch fill	M-LIA	Skull	Large mammal	1	Fragment
5	31	Ditch fill	M-LIA	Indet.	Large mammal	3	Fragments
5	31	Ditch fill	M-LIA	Scapula	Large mammal	1	Fragment
22	21	Gully fill	M-LIA	Metacarpal	Cattle	1	Complete, fused
22	21	Gully fill	M-LIA	Rib	Large mammal	2	Fragment
22	21	Gully fill	M-LIA	Radius	Sheep/goat	1	Shaft fragment
22	21	Gully fill	M-LIA	Long bone	Medium mammal	2	Fragments
22	21	Gully fill	M-LIA	Maxilla	Pig	1	P4 and M1 present
26		Ditch fill	M-LIA	Long bone	Medium mammal	1	Shaft fragment
28	25	Ditch fill	M-LIA	Medial phalanx	Cattle	1	Complete
28	25	Ditch fill	M-LIA	Molar	Cattle	2	Complete
28	25	Ditch fill	M-LIA	Femur	Sheep/goat	3	Shaft fragments
30	25	Ditch fill	M-LIA	Radius	Cattle	5	Proximal end, fused
32	31	Ditch fill	M-LIA	Metatarsal	Sheep/goat	1	Distal shaft, unfused
Total						47	

The Lithics

Lynden Cooper

A small group of lithics (t=17) were recovered: the majority, if not all, on local till-derived flint. Noteworthy was a small barbed and tanged arrowhead of Early Bronze date (Fig. 39). Other tools include a combination tool (concave scraper/piercer), a scraper fragment, a scraper on a natural pot-lid and an *ad hoc* axe. The latter was a naturally wasted cobble that had one sharpened end with additional retouch to aid balanced hafting (Fig. 40). The remaining pieces were debitage of later prehistoric date.

Table 4: Catalogue of lithics

Context	Feature	Date	Comment
SF1	Topsoil Trench 3	E BA	B and t arrowhead
u/s	Topsoil	L PH	Axe <i>ad hoc</i>
u/s	Topsoil	L PH	Scraper on natural frag
u/s	Topsoil	L PH	Concave scraper/piercer
4	Ditch fill	L PH	2ry flake
4	Ditch fill	L PH	3ry flake
7	Ditch fill	L PH	2ry flake
7	Ditch fill	L PH	2ry flake
22	Gully fill	L PH	3ry flake
22	Gully fill	L PH	Core on flake
30	Ditch fill	L PH	Core
30	Ditch fill	L PH	Core on flake
30	Ditch fill	L PH	2ry flake
30	Ditch fill	L PH	2ry flake
30	Ditch fill	L PH	2ry flake
32	Ditch fill	L PH	Scraper frag
28	Ditch fill	L PH	core

17



Figure 39: Barbed and tanged arrowhead (0.10m scale)



Figure 40: *Ad hoc* axe (0.15m scale)

The Charred Plant Remains

Rachel Small

Introduction

During an archaeological evaluation at this site three samples were taken for the analysis of charred plant remains. Sample 1 was from the fill (7) of a linear [6] prehistoric feature; sample 2 was from the fill (14) of an undated post-hole [13]; and, sample 3 was from the fill (18) of an undated pit/linear feature [15]. The analysis of the charred plant remains recovered from these samples is presented, together with a discussion of what this can potentially tell us about the diet, crop husbandry strategies and environment at the site through-out time.

Methodology

The samples were a mid-grey brown clay and were processed in a York tank using a 0.5mm mesh with flotation into a 0.3mm mesh sieve. The flotation fractions (flots) were transferred into plastic boxes and left to air dry, then sorted in their entirety for plant remains and other artefacts under a x10-40 stereo microscope. The residues were also air dried and the fractions over 4mm sorted in their entirety, whilst the residues under 4mm were scanned for remains. Plant remains were identified by comparison to modern reference material available at ULAS and names follow Stace (1991).

Results

Samples 2 and 3 did not contain any charred plant remains. Sample 1 however, contained one indeterminate cereal grain, two wheat (*Triticum* spp.) glume bases, and three large grass (Poaceae) seeds in 12 litres of soil which equates to 0.5 items per litre. The specimens were very fragmentary and this hindered identification to species. Charcoal fragments were present in all three samples, but those measuring over 2mm in length (and therefore suitable for radio-carbon analysis) were rare (less than ten items present per sample). Modern rootlets were present in the samples but only in small quantities suggesting disturbance to the contexts was minimal.

Discussion

The specimens present in sample 1 likely represent residue from processing wheat grains for consumption and food spillage that was burnt on a hearth. The former may have been added to the fire acting as good tinder. The ash would have formed a general spread across the site collecting in open features such as this linear feature.

Statement of potential

Due to the small sample size and fragmentary nature of the specimens that were present, little information was gained as to diet, crop husbandry strategies and environment at the site. This indicates limited potential for future work.

Discussion and Conclusions

University of Leicester Archaeological Services carried out an archaeological evaluation on land north of Birstall in the parishes of Wanlip, Thurcaston, Rothley and Cropston ahead of a planned Sustainable Urban Extension (SUE). The work involved the machine excavation of 48, 30m long trial trenches located where constraints allow throughout the development. Trenches were focused on the proposed access roads into the site, the areas of known archaeological activity and areas containing anomalies possibly associated with archaeological remains identified during the geophysical survey.

Due to the large area evaluated (19 fields) the topsoil and subsoil where present was varied, although all fields represented agricultural land, with the majority under arable crop. Where trenches were situated at the foot of slopes colluvium deposits were recorded under the subsoil. The natural substratum showed slight variation across the development area, predominantly consisting of orange/yellow clays with gravel-stone and natural flint inclusions.

Ridge and furrow was recorded across the majority of the development area representing agricultural farming and ploughing from the medieval period through to the present day. In trenches 9 and 10 this could be seen truncating archaeological deposits. A network of field drains was also present across site similarly truncating some archaeological deposits. The presence of ridge and furrow and field drains can be seen on the geophysical survey as well as in the excavated trenches.

Archaeological deposits were encountered in 7 of the 48 trenches. These were trenches 3, 4, 8, 9, 10, 41 and 44 (Fig. 41). The features appeared to represent postholes, pits, gullies and ditches.

Isolated postholes [11] [13] and [19] identified in trenches 3 and 44 where not visible on the geophysical survey. This is likely to be due to their small size and ephemeral nature, and could indicate the presence of further archaeological deposits in the immediate area not picked up by the geophysical survey, perhaps masked by strong ridge and furrow anomalies or because these deposits give off little magnetic response.

Similarly features [1], [16] and [15] observed in trench 4 towards the south-west boundary of the development were not seen on the geophysical survey although the ditches perhaps would be expected to show. No dating evidence was recovered from these features although environmental samples from (7) in [6] do indicated the presence of cereals, wheat and grass seed. The very nature of the features in comparison to those seen in trenches 8, 9 and 10 perhaps suggests a differing date, maybe earlier than Middle-Late Iron Age suggesting multi period activity across the site. The presence of a large amount of burnt and degraded stone in pit [15] hints towards occupational debris in the immediate vicinity and further archaeological deposits would be expected if further work was to be conducted around trench 4. Furthermore, the presence of feature [8] in trench 41 to the north-west of trench 4, again suggests further archaeological deposits would be expected in this area, even though features were not picked up on the geophysical survey.

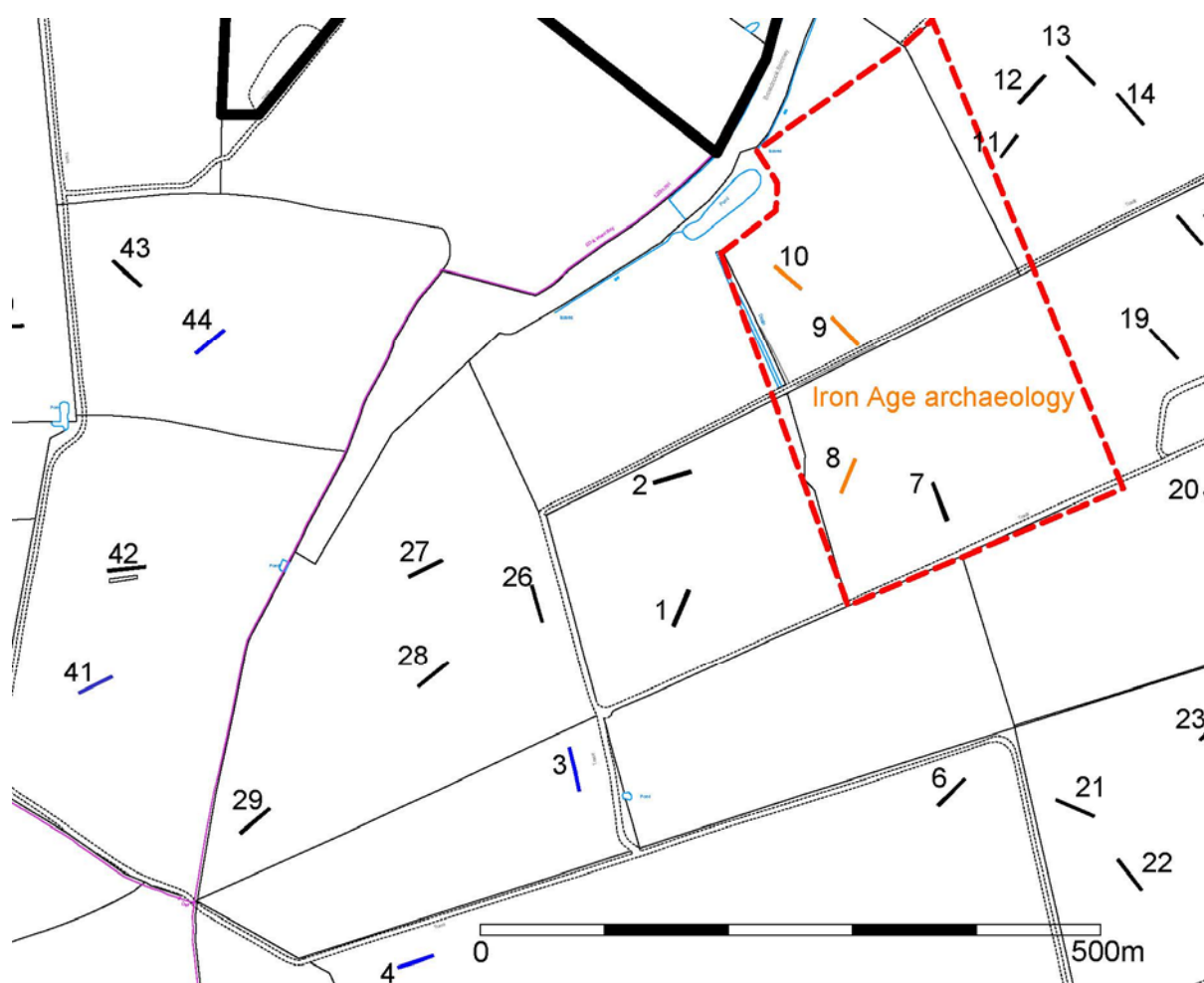

Figure 41: Trenches with undated archaeology in blue, Iron Age archaeology in orange and blank trenches in black

Ditches and gullies identified in trenches 9 and 10 appear to confirm the presence of archaeological deposits as indicated on the geophysical survey. The nature of these features combined with the recovery of Iron Age pottery in [21], [24] and [31] suggests the presence of a Middle-Late Iron Age Settlement. The amount of pottery in combination with animal bone in the features in trench 9 suggest enclosure ditches and gullies associated with buildings (roundhouses), living and domestic livestock management in the Iron Age. Ditches [25] and [33] in trench 10 to the north contained fewer finds and perhaps represent boundary demarcation of this associated settlement. Posthole [16] in trench 8 to the south of trench 9 contained further Iron Age pottery, suggesting the settlement although not as clear on the geophysical survey in this area continues at least 115m to the south of trench 9. The lack of features in Trench 11 may suggest that this trench, which was moved to avoid an area of maize, missed the geophysical anomaly. However, the absence of archaeology in trenches 12-14 to the east of the apparent settlement area (as shown on the geophysical survey) does seem to indicate archaeological deposits do not continue downslope this way.

Similar Iron Age settlement sites are present in the immediate wider landscape. To the south of the development at Hallam Farm Fields, a Middle Iron Age settlement was recorded, showing evidence of roundhouses and associated enclosure ditches (Speed 2009). To the east of the development area at Wanlip, a late Bronze Age-Middle Iron Age settlement site was recorded,

again showing evidence of a roundhouse and associated enclosures and pit activity (Beamish 1998). The archaeological deposits present in the development area could further add to the information on the Iron Age period in this prehistoric landscape.

It appears archaeological features are present across the development area, with a focus of Iron Age activity in the central – northern area and scatters of archaeology features and potential elsewhere. Trenches situated in fields on the eastern and western boundaries appear clear of archaeological deposits at this stage. A single field on the western boundary of the development (trenches 31-34) did not contain any archaeological deposits despite the presence of a lithic scatter as previously identified. It is noted that the archaeology appears to relate to higher, flatter topography within the development area, with sloping and lower lying fields being void of archaeology.

Recommendations and further work

The trial trench excavations found archaeological deposits within several areas of the site (Fig. 42). These five areas can be summarised as follows:

Trench 3: Single Post-hole [19]. Not on geophysical survey. Undated. Low potential.

Trench 4: Features [1], [16] and [15], suggesting potential structural features/occupation. Not on geophysical survey. Undated although has environmental potential. Probably Iron Age in date. High potential.

Trenches 8, 9, 10: Features identified on geophysical survey. Middle-Late Iron Age enclosure. Trenching suggests more features than seen on geophysical survey. High potential.

Trench 41: Ditch [8]. Not on geophysical survey. Undated. Moderate potential.

Trench 44: Post-holes [11], [13] [19]. Not on geophysical survey. Undated. Moderate potential.

All of these areas will be impacted by the current design and will need an archaeological mitigation strategy (Fig. 47). The majority of these areas could be mitigated by an archaeological strip around the areas of archaeological interest followed by a programme of excavation and preservation by record. A possible methodology for these area might be to strip an agreed small square around the trench and then continue to strip outwards until a suitable buffer zone clear of archaeology is reached.

The area around Trenches 8,9,10 will require a larger excavation. The excavations confirmed the results of the geophysical survey and also identified features not seen on the geophysical survey. The mitigation strategy for this area will need to include the excavation of the enclosure as shown on the survey where it will be impacted by the development. Although Trench 8 only recorded a single feature, there was a large amount of Iron Age pottery in the area suggesting that there may be a continuation of activity outside the enclosure to the south. Stripping an area around this trench would provide clarification of the extent of the features (Fig. 44).

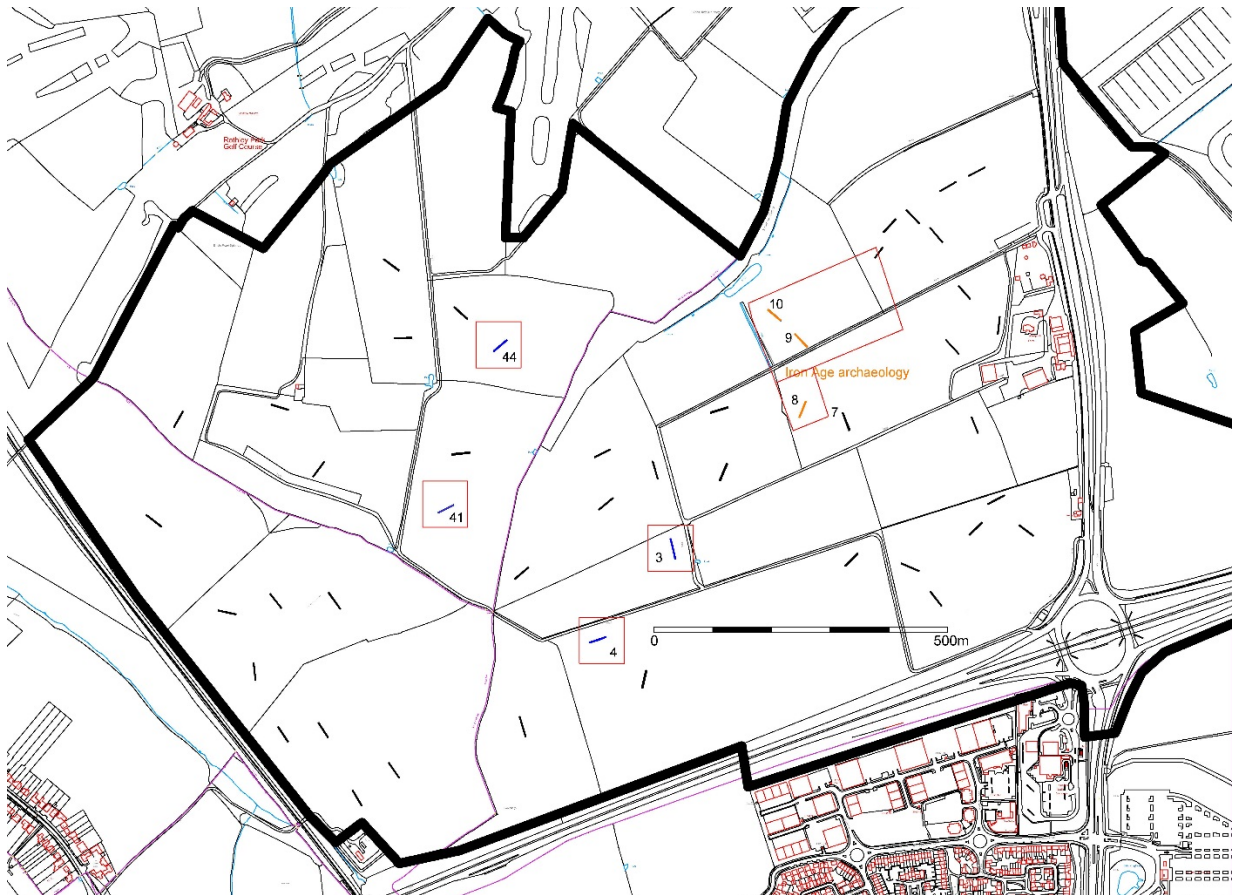

Figure 42: Areas of Archaeological potential.

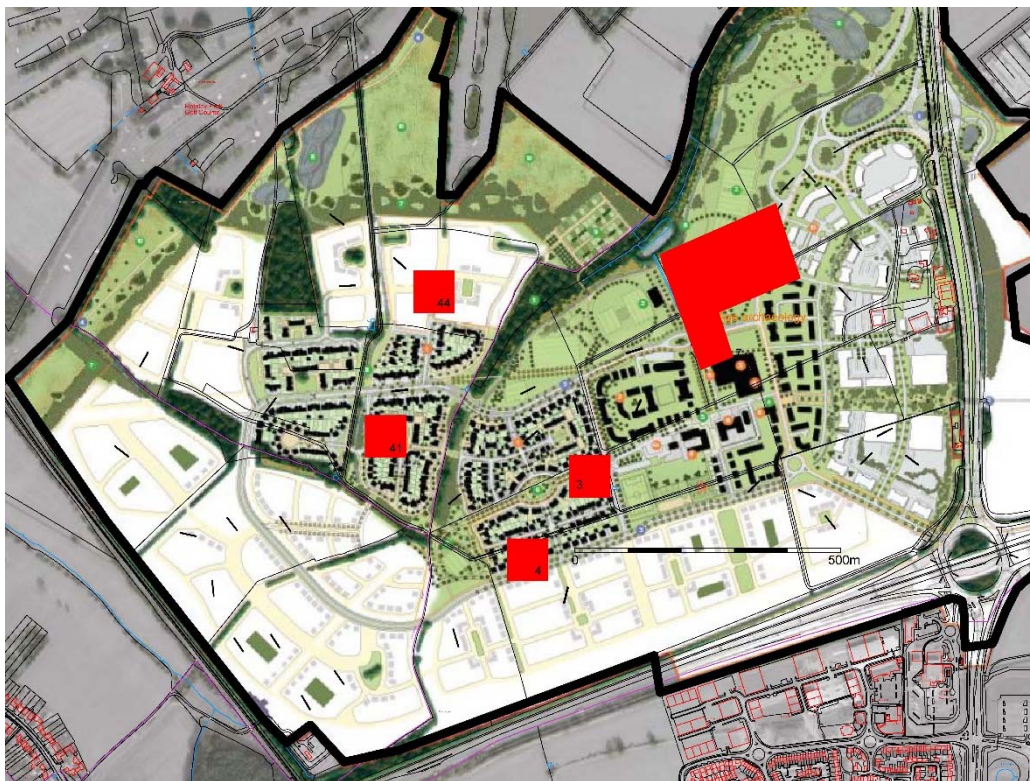

Figure 43: Areas of Archaeological potential overlain on illustrative masterplan.

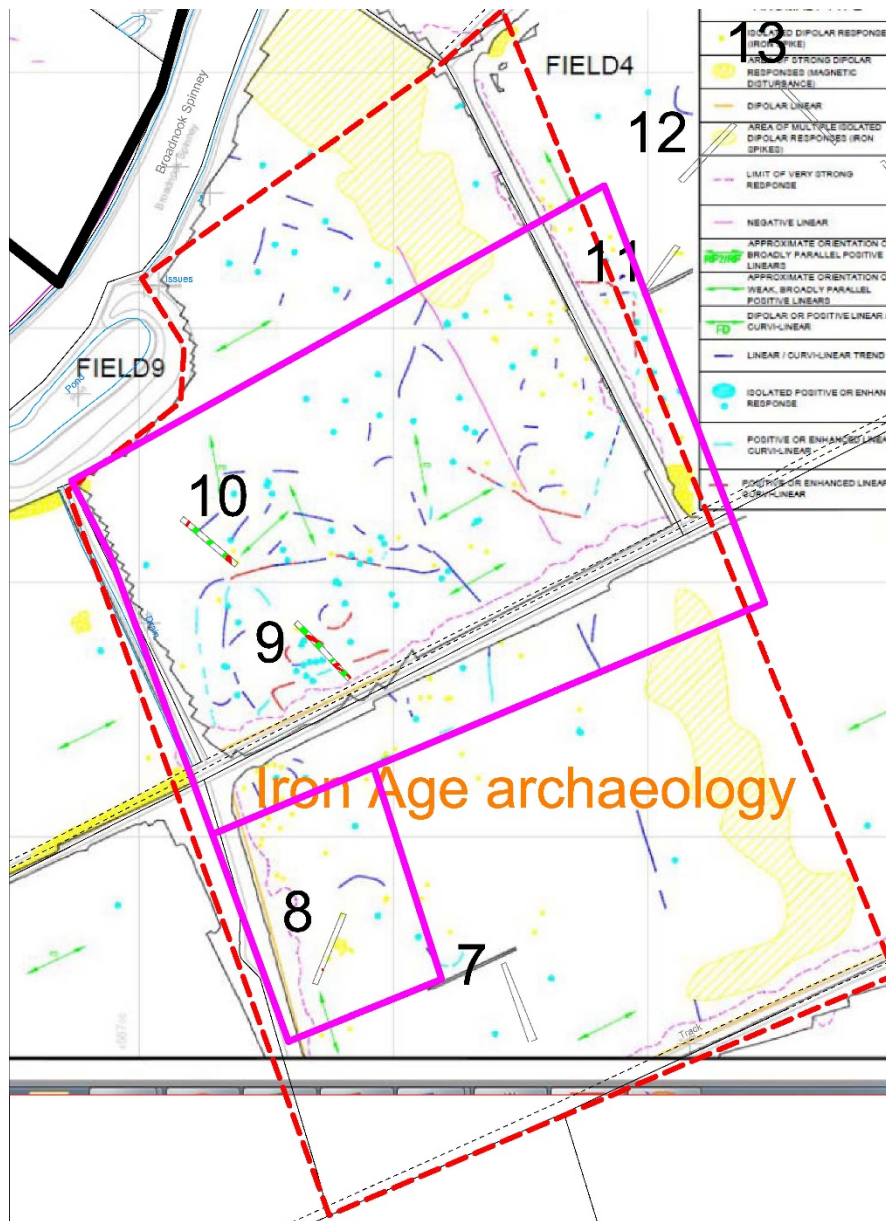

Figure 44: Details of Iron Age enclosure around Trenches 8-10.

Archive

The site archive will be held by *Leicestershire Museums Service, under accession no. X.A113.2017.*

The site archive consists of:

1 Unbound A4 copy of this report

48 A4 Trench recording sheets

6 A4 Photo record sheets

A4 Colour digital contact print 1 CD of digital photos

Drawing Sheets and Indices

Context Sheets and Indices

Publication

Since 2004 ULAS has reported the results of all archaeological work through the *Online Access to the Index of Archaeological Investigations* (OASIS) database held by the Archaeological Data Service at the University of York. A summary of the work will also be submitted for publication in a suitable regional archaeological journal in due course.

Bibliography

- Barclay A., Booth, P., Brown, D.H., Evans, J., Knight, D. and Wood, I. 2016 *A Standard for Pottery Studies in Archaeology*. PCRG, SGRP and MPRG.
- Beamish M., 1998 A Middle Iron Age Site at Wanlip, Leicestershire, *Transactions of the Leicestershire Archaeological and Historical Society* 72, 1– 91.
- Brown, D. 2008. *Standard and guidance for the preparation of Archaeological Archives* (Institute for Archaeologists)
- Chartered Institute for Archaeologists 2014. *Codes of Conduct*
- Chartered Institute for Archaeologists 2014. *Standards and Guidance for Archaeological Field Evaluation*.
- Elsdon, S. M., 1992a 'East Midlands Scored Ware' *Transactions of the Leicestershire Archaeological and Historical Society* 66: 83-91.
- Elsdon, S. M., 1992b 'The Iron Age pottery', 38-52 in P. Clay, An Iron Age Farmstead at Grove Farm, Enderby, Leicestershire. *Transactions of the Leicestershire Archaeological and Historical Society* 66, 1-82.
- Harland, J. F., Barrett, J. H., Carrott, J., Dodney, K. and Jaques, D., 2003 *The York System an Integrated Zooarchaeological Database for Research and Teaching*. http://intarch.ac.uk/journal/issue13/harland_index.html (15 November 2017).
- Hunt, L, 2017, *Written Scheme of Investigation for Archaeological Evaluation at Broadnook Garden Suburb, North of Birstall,, Leicestershire* ULAS WSI ref. **17-571**
- Marsden, P., 2011 'The Prehistoric pottery and briquetage' in J. Thomas, *Two Iron Age Aggregated Settlements in the Environs of Leicester: Excavations at Beaumont Leys and Humberstone*, Leicester Archaeology Monograph 19, 61-80. Leicester: University of Leicester, School of Archaeology and Ancient History.
- Phase Site Investigations, 2013, *Broadnook Garden Suburb, North of Birstall, Leicestershire. Archaeological geophysical survey*. Phase Site Investigations Ltd. Project No. ARC/1010/405.
- Prospect Archaeology 2014, *Broadnook Garden Suburb, North of Birstall, Leics, Heritage Desk-based assessment*.
- Speed, G., 2009 *An Excavation of an Iron Age Settlement at Hallam Fields, Birstall, Leicestershire*. ULAS Report Number 2009-080 (unpublished).
- Stace, C. 1991. *New Flora of the British Isles*. Cambridge: Cambridge University Press.

Acknowledgments

The fieldwork was carried out by Adam Clapton, Claire LaCombe, Wayne Jarvis and James Harvey of ULAS. Vicki Score managed the project. We would like to thank Anthony Cooper and his team for their assistance during the project and Mickey Hall of Planters for his work on the project.

Oasis Data

PROJECT DETAILS	Oasis No	universi1-302909		
	Project Name	An Archaeological Evaluation at Broadnook Garden Suburb, North of Birstall		
	Start/end dates of field work	02-10-17 – 20-10-17		
	Previous/Future Work	unknown		
	Project Type	Evaluation		
	Site Status	None		
	Current Land Use	Pasture		
	Monument Type/Period	Prehistoric		
	Significant Finds/Period	Prehistoric		
	Development Type	Residential		
	Reason for Investigation	NPPF		
	Position in the Planning Process	Planning condition		
	Planning Ref.	P/16/1660/2		
PROJECT LOCATION	Site Address/Postcode	Broadnook Garden Suburb, North of Birstall		
	Study Area	204 ha		
	Site Coordinates	SK 582 113		
	Height OD	60aOD-90aOD		
PROJECT CREATORS	Organisation	ULAS		
	Project Originator Brief	Local Planning Authority (CDC)		
	Project Originator Design	ULAS		
	Project Manager	Vicki Score		
	Project Director/Supervisor	Adam Clapton		
	Sponsor/Funding Body	Developer – Palmer-Tomkinson Trust and Cooper Family		
PROJECT ARCHIVE		Physical	Digital	Paper
	Recipient	Leics	Leics MusService	Leics

		MusService		MusService
	ID (Acc. No.)	X.A140.2017	X.A140.2017	X.A140.2017
	Contents	Pottery, Bone, Flint	Photos	Trench sheets, photo records, site indices, context sheets
PROJECT BIBLIOGRAPHY	Type	Grey Literature (unpublished)		
	Title	An Archaeological Evaluation at Broadnook Garden Suburb, North of Birstall		
	Author	Clapton, A		
	Other bibliographic details	ULAS Report No 2017-187		
	Date	2017		
	Publisher/Place	University of Leicester Archaeological Services / University of Leicester		

Adam Clapton

University of Leicester Archaeological Services
 University of Leicester
 University Road
 Leicester LE1 7RH

Tel: 0116 252 2848
 Fax: 0116 252 2614
 Email: ac562@le.ac.uk



UNIVERSITY OF
LEICESTER

Archaeological Services

ULAS Contact Details

Richard Buckley or Vicki Score

University of Leicester Archaeological
Services (ULAS)

University of Leicester,

University Road, Leicester LE1 7RH

T: +44 (0)116 252 2848



INVESTOR IN PEOPLE



THE QUEEN'S
ANNIVERSARY PRIZES
FOR HIGHER AND FURTHER EDUCATION
2013

