

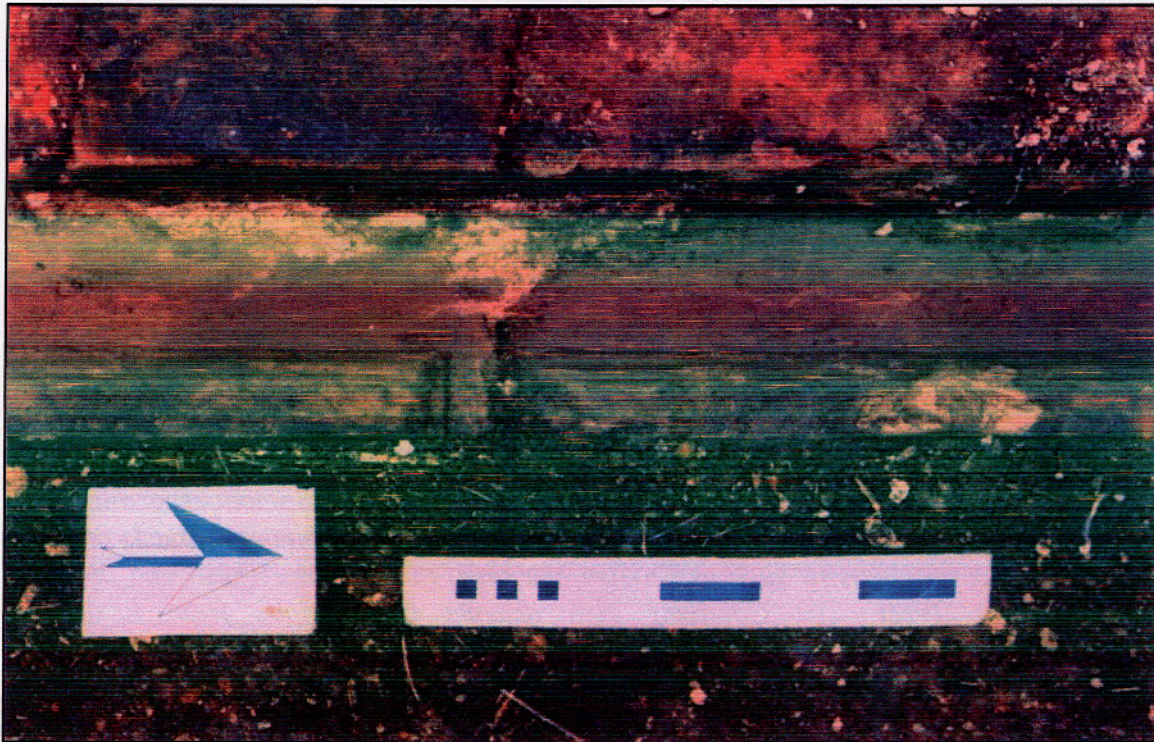

# Rooms 1-4 of the West Wing Witley Court Worcester

(NGR SO 775 658)

*Archaeological monitoring of excavations and building recording.*



**September 2007**

Hereford Archaeology Series 745

EXCAVATION • RESEARCH • GEOPHYSICS • ARCHITECTURAL SURVEY

**Rooms 1-4 of the West Wing  
Witley Court  
Worcester  
(NGR SO 775 658)**

*Archaeological monitoring of excavations and building recording.*

---

**Text**

D. Rouse

**Illustration**

D. Rouse, S. Mayes

**Fieldwork**

D. Rouse

---

**Contents**

1. Summary
  2. Introduction
  3. Historical Background
  4. Aims and Objectives
  5. Method
  6. Results
  7. Discussion
  8. Conclusion
  9. Acknowledgements
  10. Table of Small Finds
  11. Bibliography
- Appendix 1. Site archive  
Figures and Plates
- 

**September 2007**

©Archaeological Investigations Ltd

# Rooms 1-4 of the West Wing Witley Court Worcester (NGR SO 775 658)

*Archaeological monitoring of excavations and building recording.*

---

---

## **1. Summary.**

---

*The project was undertaken in response to the ongoing restoration program at Witley Court, in this case in the west wing.*

*Archaeological Investigations Ltd was commissioned by English Heritage to undertake the monitoring of excavations within this part of the building.*

*The aims of the project were to enable archaeological features to be identified or protected in the areas affected by the proposal.*

*The rooms were numbered 1-4 from south to north along the west wing. Loose pieces of moulded masonry were found in three of the four rooms where excavations were undertaken. A large amount of masonry found in rooms 1 and 4 was identified as dating to the later 17<sup>th</sup> century. Some stone from room 1 remains unidentified while pieces of Bath stone from rooms 3 and 4 dated to the late 18<sup>th</sup> or 19<sup>th</sup> centuries.*

*A moulded timber lintel from the doorway of rooms 1 and 2 was recorded by scale drawing as were the jambs of the doorway between room 1 and the stair tower.*

*Raised brick and stone ledges located along the west and east walls of room 4 incorporated pieces of 17<sup>th</sup> century masonry. Brick and stone pads were located in rooms 2 and 4, which may have been part of the support for timber floors of the 19<sup>th</sup> century phases of the building. Pottery, glass and other finds from the excavations all dated to the 19<sup>th</sup> century and later.*

---

---

## 2. Introduction.

---

The project arose in response to the ongoing restoration programme of Witley Court (WCMW 306) in this case the west wing (Fig 1). Archaeological Investigations Ltd was commissioned by English Heritage to undertake monitoring of excavations during the reduction of ground levels within the west wing.

The fieldwork was carried out between 11<sup>th</sup> December 2006 and 22<sup>nd</sup> January 2007.

The underlying solid geology consists of ancient pre-Cambrian metamorphic rocks below Devonian and Downtonian Palaeozoic Lower Old Red sandstone.

Currently the site comprises the ruins and grounds of a former stately home in the care of English Heritage.

The topography comprises landscaped park and gardens bisected by a stream valley dammed to make ponds.

The site lies at NGR SO 775 658 at a height of around 88m O.D.

---

---

## 3. Historical Background. (*After R.K.Morriss*)

---

Witley Court is a ruined multi-period mansion with elements dating back to the 13<sup>th</sup> century, once one of the largest private houses in the country and fitting its description as '*a palace, regal in size and grandeur...a supremely splendid shell*' (Pevsner, 1968, 171; 173). Its immediate pre-fire appearance owed much to a radical refacing and extension in the 1850's but the building has a very long history.

There is a reference to *Witlege* in the Domesday Survey of 1086, and by the 13th century the manor appears to have been in the hands of the Cooksey family (Walker, 1990, 7). There was a medieval manor house, on the site in the late-13th or early-14th century, as was recently confirmed by the survey and re-assessment of part of the extensive cellars. A substantially intact stone-built two-bay section under the central part of the house, formerly vaulted, was tentatively identified as the undercroft of a long-demolished solar block presumably once attached to a medieval great hall (Morriss, 1990).

In 1498, Robert Russell of Strensham, a member of one of the county's most important families, came into the Cooksey estates (Walker, 1990, 7). Although there is a reference to Great Witley Park in the late-16th century, the first reference to the Court does not occur until the first half of the 17th century when it was the home of Sir William Russell. High Sheriff and Governor of Worcester, he spent much of his wealth in support of the Crown (Gibbons, 1990, 15). Sir William gave his son, Thomas, Witley Court in 1654 but in the following year Thomas sold the 'imposing residence' to Thomas Foley, the iron master, then High Sheriff of the county (*ibid.*).

According to one authority, Thomas Harral in his book *Picturesque Views of the Severn* (1824), Foley, despite his wealth, was content 'with the situation of the old house, repaired it, and made many additions' (*ibid.*). Thomas Foley bought several other large estates in the region before he died in 1677. He was succeeded in turn by his son, Thomas, who died in 1701 and is credited with the building of 'the fair new-built house' mentioned in Camden's *Britannia* of 1695 (Gibbs & Doubleday, 1926, V, 535; Gibbons, 1990, 15). His son, another Thomas, was one of the infamous Tory peers created by Queen Anne to retain that party's majority in the Lords after the turbulent sitting of 1711/12 (Gibbs & Doubleday, 1926, 535). The new Baron Foley of Kidderminster died in 1733.

Although the Baron had, as part of major improvements to the house and its environs, planned to replace the old medieval parish church that stood a little to the north-west, this had not been carried out at the time of his death. It was his widow, Elizabeth, who obtained permission to demolish the old church that, according to the petition, was 'by reason of its antiquity ruinous and much decayed'. The new church was built closer to the house, just a short distance from its west wing. It was finished in 1735, and in December of that year, Elizabeth died (Gibbs & Doubleday, 1926, 535).

Its design has been attributed to James Gibb, and the similarity in its dimensions to the private chapel designed by him in 1719 for Canons, Middlesex, appears to have been deliberate. "Canons", the country retreat in Edgware of James Brydges, the first Lord Chandos, was the subject of much interest in the 1730's. Lord Chandos had lost most of his ill-gotten gains in the South Sea Bubble fiasco of 1720 and the house was about to be sold to pay off his debts.

Chandos and its chapel were finally pulled down in 1747 and the second Baron Foley, yet another Thomas, acquired its fine painted windows, ceilings and other fittings, including the organ case. The hitherto plain interior of the new Witley church was thus transformed into one of the finest Baroque spaces in England. The second-hand pieces did not fit exactly, but the Chandos fittings were, on the whole, easily incorporated into the church.

The second Baron died unmarried and the title became extinct. He was succeeded by yet another Thomas Foley. He was the great great grandson of the first Thomas Foley through his son, Paul, who had been given the manor of Stoke Edith, Herefordshire. This Thomas was also an MP and in 1776, the year before he died, was the second Foley to be elevated to the peerage - again as Baron Foley of Kidderminster (Gibbs & Doubleday, 1926, 535).

Towards the end of his life, he began to suffer financial problems, mainly because of the activities of his two eldest sons. It was said that '*His children, by a system of extravagance wherein no one good was done, no one worthy act performed, no one good consequence derived, tore a noble fortune to pieces*' (Royal Register Vol.iv, quoted in Gibbs & Doubleday, 1926, 536).

His eldest son and heir, Thomas Foley, was a Privy Councillor, Joint Post-Master General - and a notorious gambler; it was he that started the families' gradual decline (Walker, 1990, 10). He died in 1793 and his son, another Thomas, in 1833 (Gibbs & Doubleday, 1926, 536). Shortly after inheriting the title and lands, the next Baron - another Thomas of course - saddled with the debts of his grandfather and a huge house, sold the Witley estates in 1837 for £890,000 (Walker, 1990, 10). He died, in Paris, in 1869 (Gibbs & Doubleday, 1926, 536).

The new owners of Witley were the trustees of William Ward, a minor, who became the first Earl of Dudley in 1860. Until he came of age in 1846 the house was let; between 1843-46 the tenant was Queen Adelaide, widow of William IV (*ibid.*).

When Lord Dudley took possession of the estate he began an ambitious programme of works on both house and gardens and entertained on a lavish scale. His son, another William, inherited in 1885 and for the rest of the century and into the Edwardian era Witley Court was one of the most fashionable private houses in the country, patronised by the rich and the royal. After the tragic death of Lady Ward in 1920 and the general downturn in the post-war economy, the family decided to sell Witley. It was bought by Sir Herbert Smith - but was damaged by fire in 1937. The damage was by no means terminal, and the west wing, chapel, and link block escaped completely. However, the house was allowed to deteriorate due to the activities of vandals and demolition contractors.

A Building Preservation Order was made in 1964 and in 1972, with no obvious improvements in view, the Department of the Environment took the unusual step of taking the ruins into compulsory guardianship. Since 1984 it has been in the care of the Historic Buildings & Monuments Commission - English Heritage.

The City of Hereford Archaeological Unit/Archaeological Investigations Ltd has been involved in recording of the ongoing English Heritage repair work at Witley Court since 1990 and has produced numerous reports on the structural development of the Building and its landscape. The following reports have been produced in the Hereford Archaeology Series:

<b>The medieval undercroft:</b>	HAS 87 :	Oct 1990
<b>Assessment:</b>	HAS 92 :	Nov 1990
<b>The west wing:</b>	HAS 172:	April 1993
<b>The south west wing:</b>	HAS 214:	Sept 1994
<b>Landscape survey:</b>	HAS 215:	July 1994
<b>The link block:</b>	HAS 232:	Jan 1995
<b>Assessment of the architectural stone:</b>	HAS 235:	Jan 1995
<b>Recording the loose architectural stone:</b>	HAS 255:	Sept 1995
<b>The stables and western guesthouse:</b>	HAS 269:	Jan 1996
<b>The proposed roofs of 1837:</b>	HAS 271:	Feb 1996
<b>Landscape survey :</b>	HAS 275:	Feb 1996
<b>The boathouse:</b>	HAS 316:	May 1997
<b>The east wing bathroom:</b>	HAS 350:	Feb 1998
<b>The vets room:</b>	HAS 354:	March 1998
<b>The boathouse update:</b>	HAS 413:	May 1999
<b>The Coach Houses building survey :</b>	HAS 496:	April 2001
<b>East basements building survey:</b>	HAS 506:	Nov 2001
<b>The stair tower building survey:</b>	HAS 507:	Nov 2001
<b>Stair tower and south-west wing, archival report:</b>	HAS 605:	Oct 2003
<b>Radar Survey and Trial Pits, evaluation:</b>	HAS 702:	Feb 2006

---

---

#### **4. Aims and Objectives.**

---

The project was considered likely to produce results that would be of national archaeological importance.

The main aim of this phase of work was to enable archaeological features to be identified or protected in the areas affected by the proposal.

The objectives of the work were to:

- a) Identify the date and nature of features being investigated.
- b) Assess survival, quality, condition and relative significance of any archaeological features, deposits and structures within the study area.
- c) Produce a record of the features or ensure they are preserved.

---

---

#### **5. Method.**

---

All archaeological features were recorded in plan at a scale of 1:20, and photographed using 35mm black and white negative and colour film. Section drawings were also made at 1:20 scale. Notes and sketches were made in a site notebook during the excavation carried out on site.

The stratigraphic sequence was ascertained by examining the sections exposed and by comparing these with the recent excavation records (Daffren and Boucher, 2006). No excavation was carried out beyond the specified works.

The context records from the previous excavation (HAS 702) were used to save repetition of recording. Context sheets were used to record small finds (in this case moulded masonry and plaster), which were also photographed with scales. As there were several small find pieces with identical mouldings and details, the best preserved pieces were drawn at 1:2 scale, smaller pieces of stone/plaster and moulding profiles were made at 1:1 scale.

Recording was in accordance with Archaeological Investigations Ltd's site manual. Registers were kept for context records, photographs, drawings and small finds on site.

Biological Samples were not collected or retained as no archaeological deposits were encountered that warranted sampling.

Pottery, tile, bone and glass from stratified contexts were retained for further analysis and dating.

### 5.1 *Variations to original method.*

Further to the works agreed in the project proposal, it was requested that detailed photography with scales, and scale drawings of the jamb elevations of the newly re-opened doorway between Room 1 and the stair tower were made for completeness of the building record.

It was also requested that an oak, moulded timber which had been removed from above the doorway in Room 2 (connecting to Room 1) was recorded by drawing at 1:10 scale and profiled at 1:1 scale.

---

---

## 6. Results

---

A plan of the West Wing is included (at 1:100 scale) locating rooms 1-4 and the features mentioned in the results section (Fig 2).

---

### 6.1 Excavation of a spoil heap in Room 2

---

A rectangular stone and brick "chamber" located near to the west wall in Room 2 of the West Wing was inadvertently emptied by workmen (due to a misunderstanding). The "chamber" is thought to possibly belong to a medieval phase of the building and therefore the contents of the primary fill of this structure were thought to be of potential archaeological interest. As a result it was considered worthwhile to carefully excavate the spoil heap left after the excavation to see if the primary fill could be identified and if any dateable evidence was forthcoming.

#### 6.1.1 Excavation of the spoil.

The spoil heap was divided into quarters then two opposing quarters (SE and NW) were excavated (Plate 1). The excavation revealed that three layers relating to distinct fills could be identified. The uppermost layer on the spoil heap, which had presumably been the primary layer (102) was a red-brown mixed deposit consisting of sand, mortar and silt. Brick, mortar fragments and stone were included in the fill as well as a plastic soft drink bottle and an aluminium lager can.

The deposit lay over a broken baluster and a small pocket of mixed soil that appeared to be a mixture of 102/101. The baluster (pers com anonymous Bowden Ward employee) came from within the east wall of the West Wing when the previous phase of repair and rebuilding work was carried out, and had been dumped into this convenient hole.

The next deposit (presumably the secondary fill of the "chamber", 101) consisted of reddish-brown gritty sand that included fragments of mortar, sand brick and stone rubble. Finds from the deposit included a plastic document wallet, paper, wood and other very modern items such as insulating foam.

Layer 100, which must have been the upper-most, recent deposit consisted of a greenish brown mixed deposit of clay and silt containing small pieces of sandstone rubble, mortar, and sand. Finds within the deposit included string, fresh wood and a confectionary wrapper. Two sections of the spoil heap were drawn at 1:10 scale, and photographs were taken with scales.



---

## 6.2 Excavation of floor levels in Rooms 1-4

---

Excavation by hand digging was required to reduce the floor levels in rooms 1-4 by around 0.15m which, due to the buildings' status required archaeological monitoring and recording. Rooms 1-5 of the West Wing had recently been the subject of an archaeological evaluation (Daffren and Boucher, 2006), in the interests of continuity, the same context numbers and soil descriptions used for the evaluation were used for this stage of the works.

### *6.2.1 Room 1.*

Excavation commenced in Room 1, the upper soil horizon (1001) consisted of moderately compacted dark reddish-brown sandy silt averaging around 0.05m deep. Finds were mostly quite modern (brick, tile, lead off cuts, string, plastic, foam insulation) and related to recent repair work carried out in the West Wing.

The lower horizon (1002) consisted of a very similar soil but less dark in colour than 1001. Modern finds were still fairly common near the top of the deposit, but also included were fragments of 19<sup>th</sup> century pottery, clay pipe stems, rusted iron nails and plaster/mortar fragments. The excavation of this deposit did not exceed 0.10m deep. The soil that was excavated from the floors of rooms 1-4 was virtually the same unless otherwise stated.

In the north-west corner of Room 1, within 1002 and forming a rough triangle, was a selection of dumped dressed masonry, stone rubble and brick (Plate 2). The area occupied by the stone and brick measured 1.5m along the west wall by nearly 2m on the north wall by 2.10m across the angle. Four pieces of stone had to be removed because they were above the required finished level, but most of the remaining stone and brick was left in situ. The location of the stone group was sketched onto a plan at 1:100 scale.

The excavated stones were examined. The two largest pieces (SF 1 and SF 2, Fig 3) were moulded red sandstone, and appeared to be broken window sills or more likely, lintels (Plates 3 and 4). The mouldings were identical on both pieces. The stones measured 0.28m wide by 0.20m high. One was 0.285m long to its broken end, the other was 0.40m long. The top face of the stones measured 0.12m wide with chamfered edges to angled stops. On the top face was a central glazing slot and a 1" (2.5cm) V shaped socket, for either a glazing rod or a bar.

One face was flat and vertical, while the other face had an angled fillet forming a step or sill. The end, bottom and one side face were all heavily tooled, probably to aid mortar keying.

The other two stones (SF 8 and 9) removed from 1002 were also red sandstone (see Plate 4). Neither were dressed or obviously tool marked, both were very worn and had no diagnostic features.

The excavated lintels appeared to match those of a surviving 17<sup>th</sup> century ground floor window located in the entrance hall (Plate 5).

All the stone and other small finds recovered during the excavation of rooms 1-4 have been put away in safe storage in one of the stable yard lock-ups on site at Witley Court.

Below is a table briefly describing the contexts encountered in Room 1.

Conte	Type	Description
1001	Deposit	Dark reddish brown, Sandy Silt.
1002	Deposit	Mid reddish brown, Sandy Silt with fragments of building material i.e. plaster, mortar and stone, (Small finds 1, 2, 8 and 9)

### 6.2.2 Room 2.

The deposits in Room 2 were much the same as those described in Room 1. Finds from the two layers encountered in Room 2 (2001 and 2002, see table below for soil description) were all from the 19<sup>th</sup> century and included glass, nails and pottery, or were modern and like those encountered in Room 1.

The underlying sandstone bedrock was especially close to the surface over the western half of Room 2. When the ground level was reduced, bedrock was exposed directly under the west half of the north wall. The bedrock sloped downwards towards the southern half of the room.

A small brick base was exposed adjacent to the ridge in the bedrock against the north wall, with a corresponding base of the same size (0.25m x 0.20m) in the same position against the south wall. Another, slightly larger base was present adjacent to the doorway between rooms 2 and 3 measuring 0.28m x 0.45m. The exposed features were photographed and drawn at 1:100 scale. The position of the stone/brick chamber was also located on plan at 1:100 scale.

Below is a table briefly describing the contexts encountered in room 2.

Conte	Type	Description
2001	Deposit	Dark reddish brown, Sandy Silt.
2002	Deposit	Mid Reddish Brown, Sandy Silt with fragments of building material i.e. plaster, mortar and stone.

### 6.2.3 Room 3.

The soil make up in Room 3 varied from that described for rooms 1 and 2. The topsoil (3000) was the same but disturbed and underlying it was a patchy spread of plaster/mortar debris (3004). The mortar spread overlay 3001, which was the equivalent of 1002/2002, but with a higher concentration of charcoal and regular small fragments of Oolitic limestone (Bath stone) inclusions.

The natural sandstone bedrock was exposed by excavation, lying immediately below the middle of the south wall of Room 3 and forming a central square block measuring 0.60m x 0.75m.

Finds from the layers mostly dated to the 19<sup>th</sup> century, or were modern (as in rooms 1 and 2). A piece of moulded stone baluster (SF 7), probably dating from the late 18<sup>th</sup> century or early 19<sup>th</sup> century was found within layer 3001 (Plate 6). The stone was creamy coloured Oolitic limestone (Bath stone) with mouldings consisting of a 3.25cm deep, square shaped base with a collared roll on top. The details above the collar were lost as the stone was broken off at an angle at this point. Under the square base was a roughly cut, rounded plug, the face of which was 2.5cm deep and appeared to have been roughly cut back to a curve. On the underside and central to the base was a recessed lozenge, about 7cm long x 3mm deep (Plate7).

Below is a table briefly describing the contexts encountered in room 3.

Contex	Type	Description
3000	Deposit	Dark reddish brown, Sandy Silt containing modern intrusions such as scaffolding clamps and planks. (Cleaning Layer)
3001	Deposit	Mid reddish-brown, medium-coarse sandy loam. Frequent plaster and mortar inclusions (<10-90cm) and occasional charcoal inclusions (10-
3004	Deposit	Light greyish brown medium coarse sand. Frequent reddish-orange brick and tile (<12 x 6 cm) and frequent white mortar and plaster fragments.

#### 6.2.4 Room 4.

The soils encountered in room 4 varied only slightly from rooms 1 and 2 and were quite similar to Room 3. The topsoil (4000) was the same but disturbed and in places mixed with material from the layer below, probably by an apparently unrecorded excavation in the middle of the room. Underlying 4000 was 4001, a layer equivalent to 1002/2002/3001. Below that and only partly disturbed by the excavation was 4007, a layer containing sand, mortar and plaster that was similar to 3004.

Two pieces of moulded stone (SF 3 and SF 4) were excavated from layer 4001, both were red sandstone measuring 17.5cm wide across the face by 15.25cm deep, the lengths varied (28cm and 36cm long) as both stones were broken. The rectangular stones were transoms or mullions with centrally located glazing slots cut into the side faces of both stones.

Mouldings ran down the edges of the front and back faces of the stones, some of which were broken. The mouldings took the form of a flat band 1¼" (almost 3cm) wide to the outside edges, with a cyma reversa moulding to the inner face, the whole of the moulding being 2" wide (just over 5cm) by ¾" (2cm) deep (Plates 8 and 9). Traces of grayish green paint were present on several faces of the stones.

The moulded stones matched the transoms and mullions from the 17<sup>th</sup> century window located in the entrance hall (mentioned in Room 1 [Plate 5]) which probably dates to the 1670s, figure 3 shows details of the window.

#### Other finds from context 4001.

A fragment of battered moulded Bath stone (SF 5) which probably dated to the later 18<sup>th</sup> or 19<sup>th</sup> centuries was also found in layer 4001. The moulding appears to include a roll to a fillet with the start of possibly another roll (Plate 10).

Also coming from 4001 was a broken piece of red-brown ceramic brick/tile (SF 6) measuring 15cm long by 10 cm wide by 5cm deep with 2 raised rounded bars, both 1cm wide by 1cm high (see Plate 10). The piece had an angled corner with two faces sloping at approximately 45°. The piece appears to be a fragment from a fireplace.

Further to the above, a piece of plaster moulding (SF 11) was also excavated from 4001. The plaster is broken but the surviving piece of moulding curves to a fillet then rolls to a further curve. The piece measures 4.5 cm wide by 7.5cm high by 12.5cm long.

As the excavation of Room 4 progressed, rows of bricks butting the east and west walls were left proud exposing an underlying line of cut and dressed stones. On closer inspection the stones were identified as being more of the same red sandstone mullions and transoms already excavated from within the room (see small finds 3 and 4) and dating to the 17<sup>th</sup> century. At least twelve pieces had been re-set and re-used along the walls to level the brickwork that was used to carry the timber floor in Room 4. Many of the pieces appeared to be complete, if a little damaged in some cases with spalled mouldings (Plates 11, 12).

Against the south wall was what appeared to be a pad, or support consisting of four, slim sandstone blocks with mortar adhering to the upper surface, possibly where additional stones or bricks were previously set. The structure measured 0.36m x 0.30m and is likely to have been part of the floor support.

A single piece of sandstone measuring 0.30m x 0.26m lay adjacent to the north side of the hearth of the fireplace in Room 4. This stone was probably part of the supporting structure for the floor too. All the stones including those lining the west and east walls appeared to lie at approximately the same level. The features were all left in situ, photographed with scales and drawn at 1:20 scale (Fig 4).

Below is a table of the contexts encountered during the excavation of room 4.

Context	Type	Description
4000	Deposit	Dark reddish brown, Sandy Silt containing modern intrusions. (Cleaning Layer)
4001	Deposit	Mid reddish brown, medium sandy loam. Frequent broken tile and brick (2-12 cm), frequent plaster and mortar (>1 - 7 cm) and occasional charcoal lumps (1-3 cm). Very disturbed by bioturbation and modern activity.
4007	Deposit	Light pinkish white, coarse sandy mortar and plaster. Frequent brick and tile (3-12cm). Mild bioturbation and cut at western end by 4002.

### 6.3 Oak timber re-used as a lintel, (Room 2)

During the consolidation works carried out in Room 2, a timber lintel was removed from above the doorway between rooms 1 and 2. On removal it was discovered that the oak timber which had 7 mortice holes along the only previously visible face, also had a moulded face on the opposite side that had until now been hidden inside the wall. The dimensions of the (quite rotten) timber were 12.25cm wide by 19cm deep by 1.56m long (Plates 13 and 14).

The mouldings on this previously hidden face consisted of a Torus (or bull nose) central to the face with fillets and flanking hollow chamfered edges.

On closer inspection of the opposite face (the face with the mortices), it was observed that the outer edges were also filleted. On one side the fillet met a flat face, on the other side there was a roll to a flat face. The mortices each measured 8-9cm deep by 4cm wide and 11cm long.

Six peg holes, each measuring 1" (2.5cm) in diameter pierced the "sides" of the timber. All but two cut completely through the timber while the others, which were offset to each other but cutting into the same mortice (from opposing sides), only cut to the mortice. One of the holes still had a broken peg and one had been partly filled with white mortar or plaster. On one side there was a large knot towards the end of the timber, both ends appeared to have been cut at a slight angle.

Also along the "sides" of the timber were traces of what appeared to be long, 1" wide grooves (approximately 1cm deep). The grooves appeared to have run centrally along the length of the timber faces at a slight angle to each face (Fig 5).

---

#### **6.4 The doorway between the Stair Tower and Room 1 (Fig 6)**

---

The concrete blocking was removed from a former doorway (inserted as part of phase 2, early 18<sup>th</sup> century [Plate 15]) between the west stair tower and Room 1 of the West Wing. The unblocking of the door did not require archaeological supervision, but the revealed door jambs required archaeological recording to complete the records of this part of the building. The recording took the form of scaled photography as well as drawing of three elevations at 1:20 scale.

The drawn elevations included the east and west jambs as well as part of the north wall face immediately adjacent to the west jamb. This part of the north face was recorded as there was a recess in the doorway that was not visible when previous recording was carried out in room 1. Both the west and east jamb faces were quite roughly finished, with lots of visibly cut back brickwork. Voids, stepped brickwork and previously repaired areas were observed on both of these faces.

Soft, white plaster characteristic of the 19<sup>th</sup> century building internal finish partially coated both jambs, it had not survived very well for the most part, and only the bonding coats (first and some of the second layer of plaster) survived at all.

##### 6.4.1 West jamb.

The plaster survived best on the west jamb where the cross hatch pattern for keying the next coat was still visible in the top half of the elevation. Towards the angle (9cm from the corner) with the north face, there was irregular 6-12cm stepping back in the face.

On the south angle of the west jamb, from 0.44m (6 brick courses) above the present concrete floor level in the stair tower, the brickwork had been cut back, 2cm deep by 8cm along the south face. (This detail has been drawn as part of the stair tower record and is not reproduced here as a figure).

##### 6.4.2 East jamb.

Overlying the traces of white plaster on the east jamb was a patchy coating of more modern pinkish plaster. The finish of this plaster suggested that something like plastic sheeting (traces of which were sealed into some of the surrounding brickwork) had been applied to the surface while it was still wet, leaving a smooth impression pressed into the surface.

---

---

## 7. Discussion

---

### *The spoil from the stone "chamber" in Room 2.*

The excavation of the spoil heap, after its removal from the stone chamber in room 2 produced no evidence for a medieval date. In fact it would appear from the evidence that the chamber fills contained only modern finds, suggesting that it was probably cleaned out in modern times.

### *The moulded sandstone from rooms 1 and 4.*

The excavation to reduce the floor levels in the West Wing produced a significant amount of 17<sup>th</sup> century moulded sandstone masonry, all from rooms 1 and 4 and all appearing to be parts of windows. All these pieces were parts of either transoms, mullions, sills or lintels. A single comparable 17<sup>th</sup> century "cross-mullioned" window is visible at ground floor level in the main entrance hall. The stones from below the floors in rooms 1 and 4 were deposited as a result of alterations carried out during the radical changes of the 1850s.

### *Other stone finds from rooms 1 to 4.*

Two other sandstone pieces recovered from Room 1 were not moulded, were very worn and largely un-diagnostic, these stones could possibly have come from a medieval building phase, but could also be later.

The broken baluster base from Room 3, and the broken moulding from Room 4 are both cut from Bath stone (Oolitic limestone). As there is no evidence of this type of stone being used at Witley Court prior to the mid 18<sup>th</sup> century it seems most likely that these stones relate to the work carried out by John Nash in the later 1700s, also deposited as a result of the 1850s alterations.

### *The timber.*

The re-used moulded timber is intriguing, it does not appear to be obviously part of a building. The mortice holes and mouldings suggest that it could have been part of some kind of furnishing, possibly the top of something like a screen or a pew/bench or even possibly (but less likely) a banister rail from a landing stage. The timber may have come from the 17<sup>th</sup> century house, presently it remains unidentified.

---

---

## 8. Conclusion

---

A large selection of fairly significant 17<sup>th</sup> century stonework was uncovered through the excavation, and the location of similarly important stone is now known. Of the stone that was left in situ in room 1 there were at least another two pieces of quite substantial dressed and/or moulded stone with diagnostic features which may well be worth further investigation.

In conclusion the aims of the project were satisfied and the methods used were appropriate in this case. Archaeological features were identified, recorded and protected in the areas affected by the proposals.

The excavated stone has been placed in safe storage, the exposed brick and stone pads, and the stones still in situ in rooms 1 and 4 were protected with a terram membrane before being covered with stone and gravel

---

## 9. Acknowledgements.

---

Thanks to Brian Bowden and the crew from Bowden and Ward for their friendly, helpful attitude and assistance, especially in moving heavy stones to storage, and the use of their site cabin which was much appreciated during the cold and windy weather.

---

## 10. Table of Small finds.

---

S.F	Context	Type	Drawn	Description
1	1002	Masonry	1:1/1:2	Moulded red sandstone lintel, large broken piece (17 <sup>th</sup> C ?).
2	1002	Masonry	No	Moulded red sandstone lintel, large broken piece (17 <sup>th</sup> C ?).
3	4001	Masonry	1:1/1:2	Moulded red sandstone transom or mullion, broken piece (17 <sup>th</sup> C ?).
4	4001	Masonry	No	Moulded red sandstone transom or mullion, broken piece (17 <sup>th</sup> C ?).
5	4001	Masonry	1:1	Moulded Bath stone, broken fragment, unidentified (18 <sup>th</sup> -19 <sup>th</sup> C).
6	4001	Ceramic	No	Red-brown, fireclay, probably a piece from a fire surround (date ?).
7	3001	Masonry	1:1	Moulded Bath stone baluster, broken piece (18 <sup>th</sup> -19 <sup>th</sup> C).
8	1002	Masonry	No	Red sandstone, un-diagnostic, worn block, uncertain date.
9	1002	Masonry	No	Red sandstone, un-diagnostic, worn block, uncertain date.
10	4001	Plaster	1:1	Small piece of unidentified moulded plaster, probably 19 <sup>th</sup> century.
11	4001	Plaster	1:1	Small piece of moulded plaster cornice (?), probably 19 <sup>th</sup> century.

---

---

## 10. Bibliography.

---

- Morriss, R, K, 1990. "Witley Court, An Assessment of Research, Survey and Analysis Work to Date and Suggestions for Further Work to be Done". *Hereford Archaeology Series 92*.
- Morriss, R, K, 1993. "Witley Court, An Interim report on the West Wing". *Hereford Archaeology Series 172*.
- Stone, R, 1995. "Witley Court, Assessment of the Loose Architectural Stone". *Hereford Archaeology Series 235*.
- Stone, R, 1995. "Witley Court, Recording of the Loose Architectural Stone". *Hereford Archaeology Series 255*.
- Rouse, D, and Morriss, R, K, 2001. "Witley Court, the Main Stair Tower, building recording." *Hereford Archaeology Series 507*.
- Daffren, N, and Boucher, A, 2006. "Work on the West Wing, Witley Court, Archaeological Evaluation and Radar Survey". *Hereford Archaeology Series 702*.
- Pardoe, B, 1986. "Witley Court and Church, Life and Luxury in a Great Country House". *Peter Huxtable Designs Ltd*.
- Brown, M, and Stansfield, G, 1992. "The Fountains Of Witley Court". *Village/Peter Huxtable Designs Publication*.



---

---

**Appendix 1. Site archive.**

---

1. 28 site drawings on 5 sheets of perma trace
2. 1 Drawing register
3. 3 Colour, 36 exp, 35mm film (negatives and photo's)
4. 2 Black and white, 36exp, 35mm film (negatives and photo's)
5. 5 Photographic registers
6. 32 Context record sheets (28 recording small finds)
7. 1 Context register
8. 1 Small finds register
9. A copy of this report
10. Finds/small finds from the excavation



Reproduced from the Ordnance Survey mapping, by permission of the Controller of Her Majesty's Stationery Office - Crown Copyright. Archaeological Investigations Ltd Unit 1 Premier Business Park, Faraday Road, Hereford HR4 9NZ License No. AL100015338

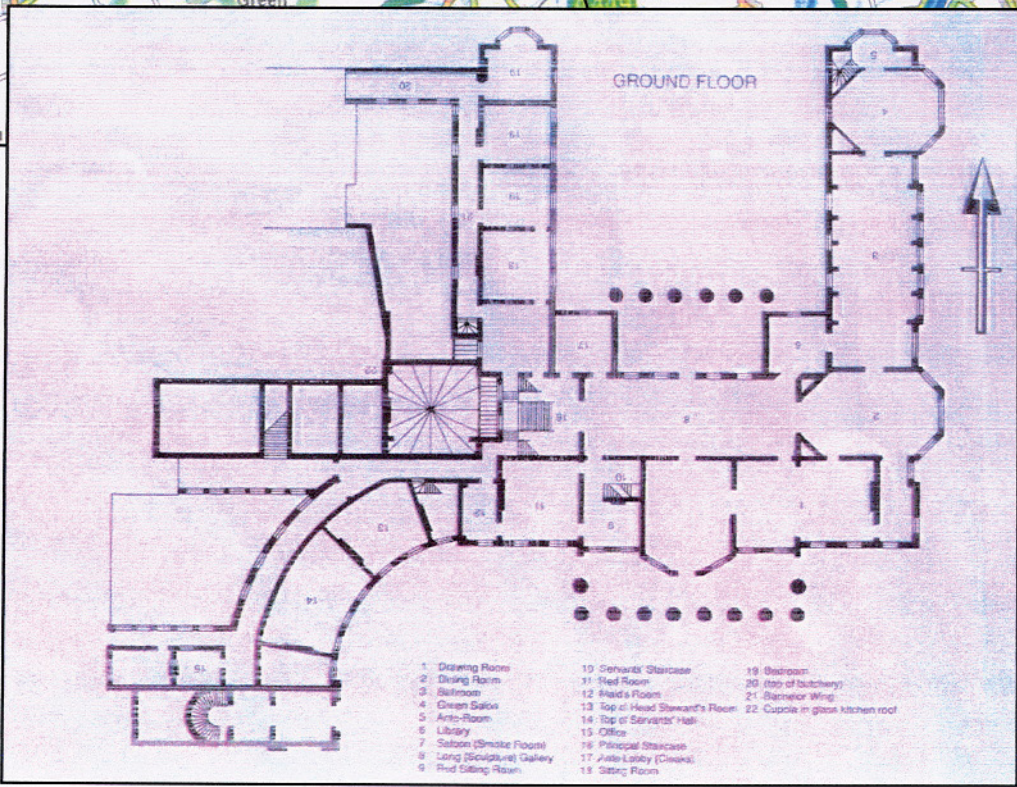

Witley Court location, Fig 1.

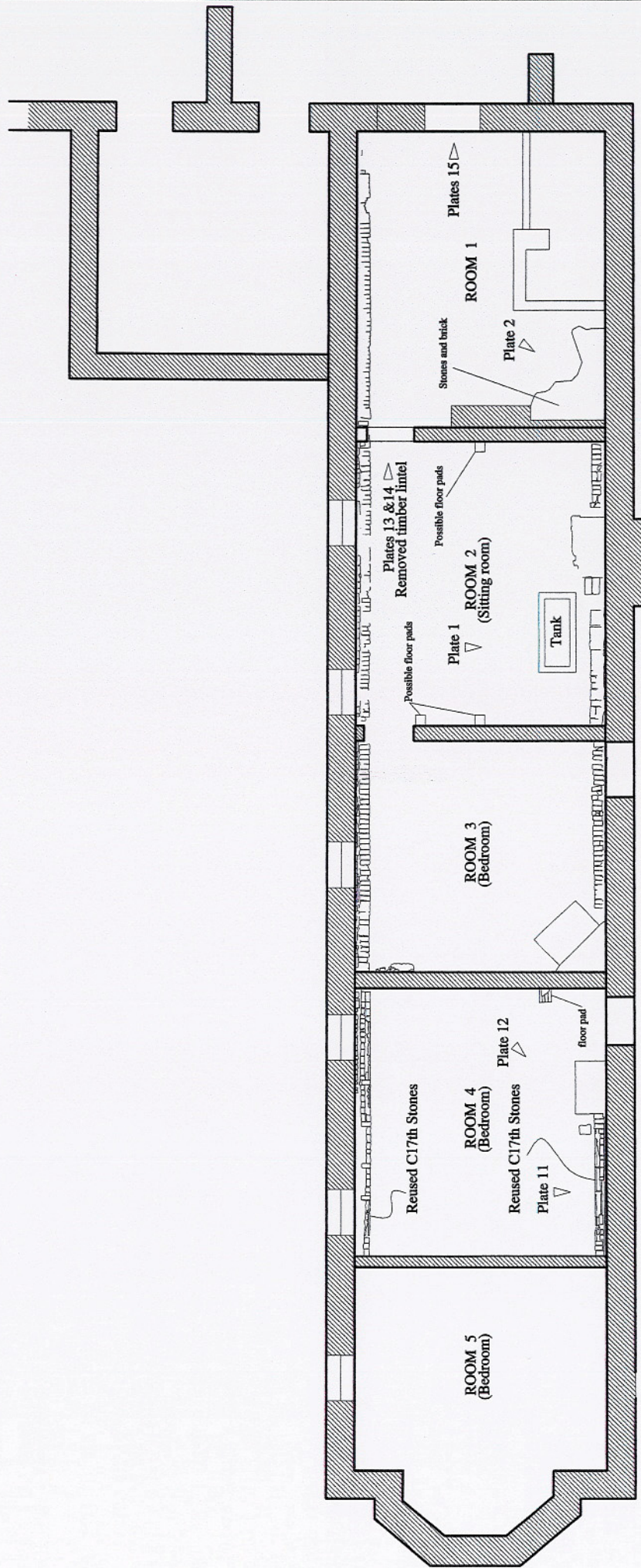

WITLEY COURT WEST WING  
 GREAT WITLEY  
 WORCESTERSHIRE

WEST WING, GROUND FLOOR PLAN



Room 1 - 4, locations of features observed during the excavation.

Fig 2.

Front view  
(SF 3)

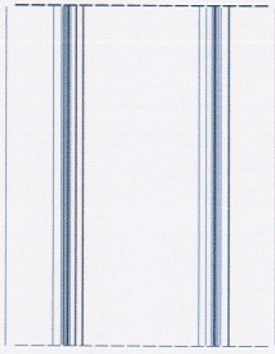

Moulding recovered from excavation (SF 1).



Glazing slot

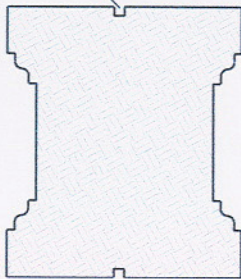

Profile  
(SF 3)

Moulding recovered from excavation (SF 3).



Front elevation.

Moulding recovered from excavation (SF 1).

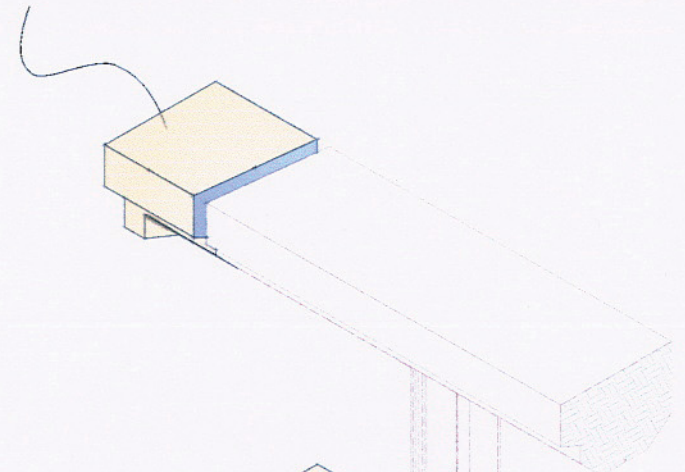

0 10 cm

V shaped socket.

Top down

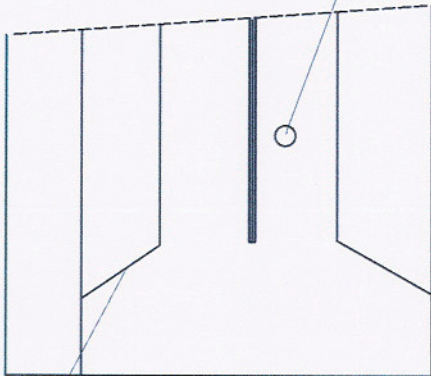

Chamfer

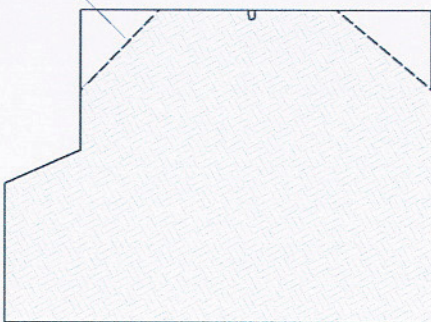

Profile of lintel  
(SF 1)

0 10 cm

Moulding recovered from excavation (SF 3).

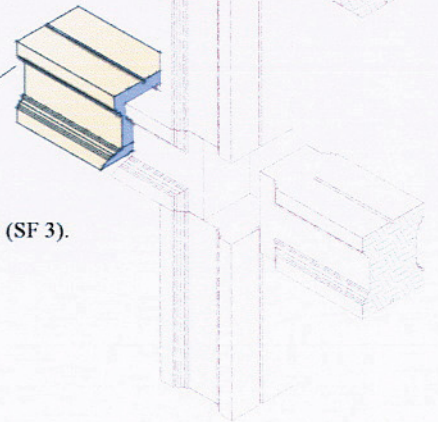

Isometric elevation.

Profiles and reconstruction drawings.

Fig 3.

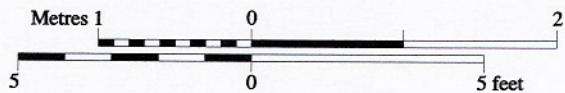
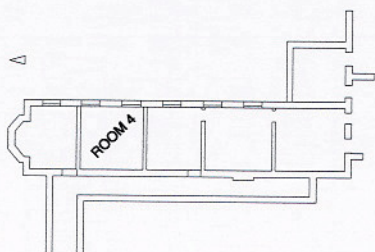
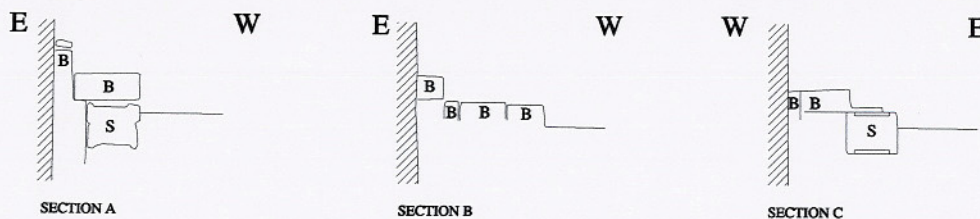
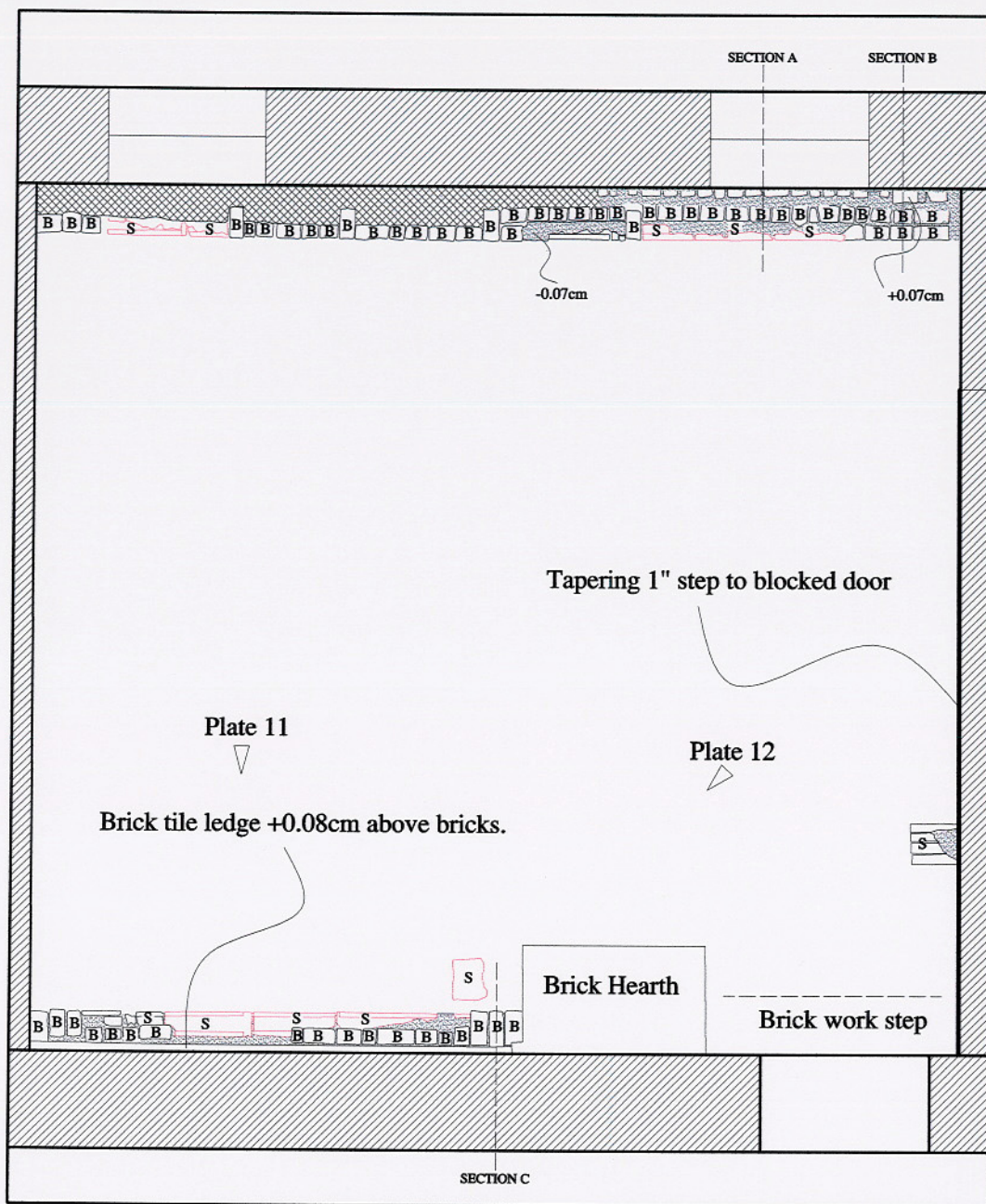

- B Brick
- S Stone
- Details obscured
- Mortar

Locations of C17th stones, reused as part of the C19th floor supports.

Fig 4.

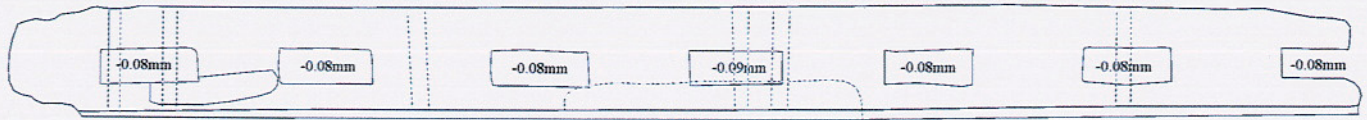

Bottom view

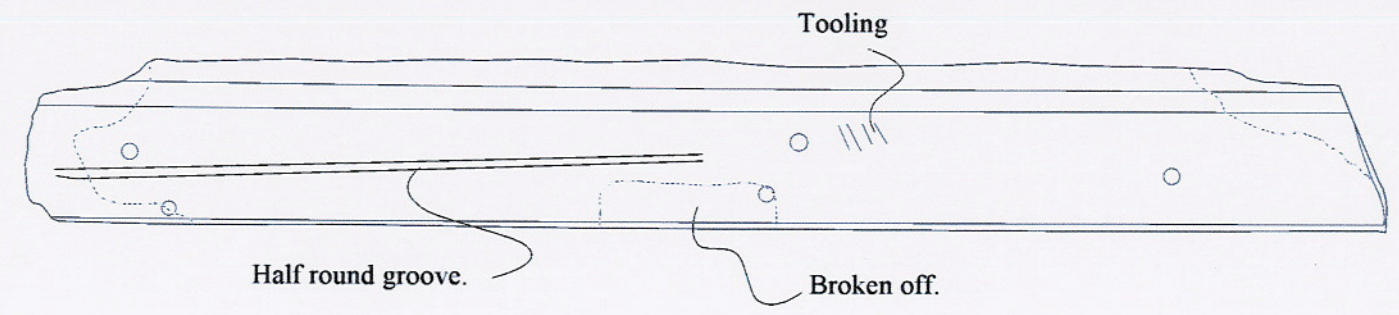
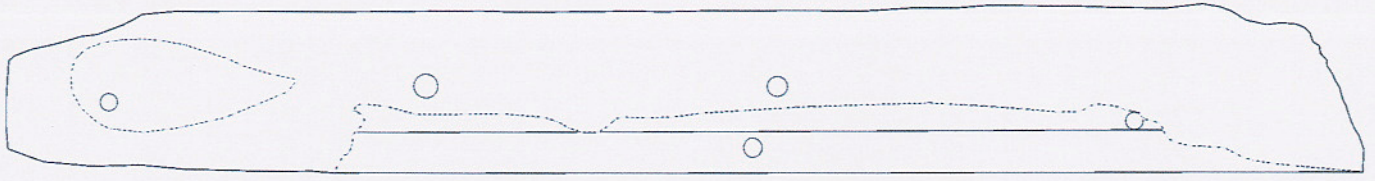

Top down



Profile.

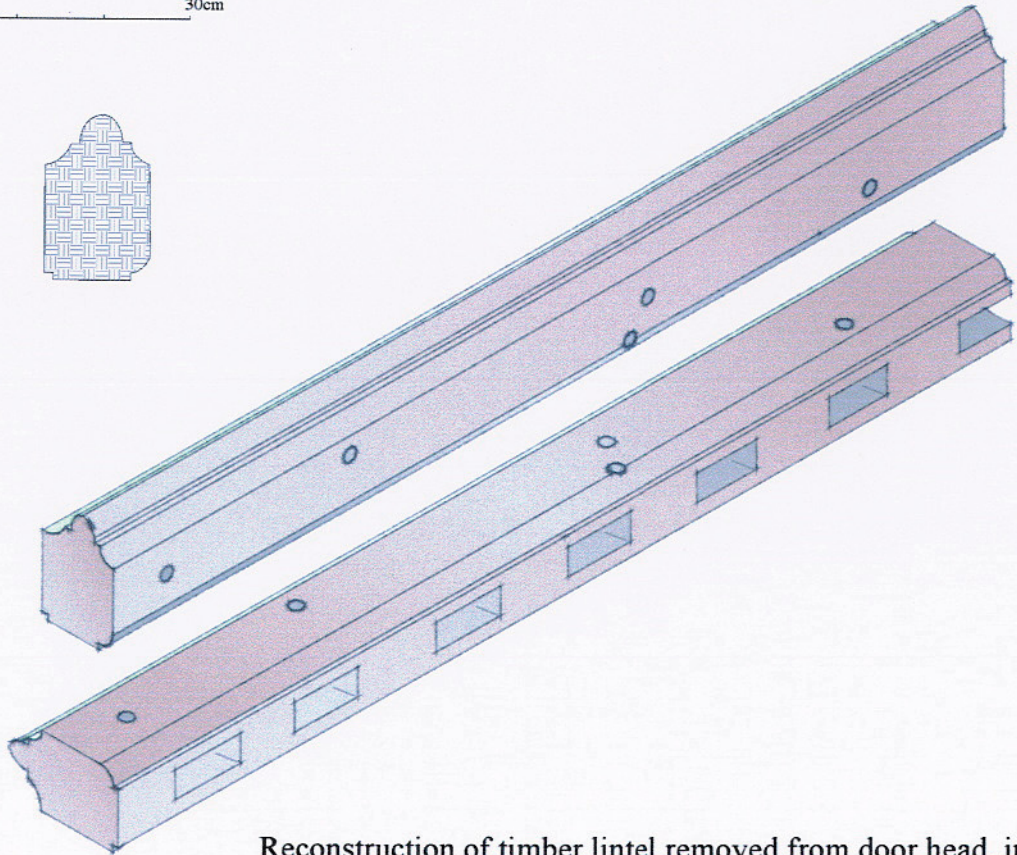
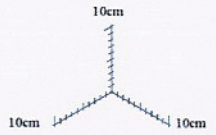

Reconstruction of timber lintel removed from door head, in room 1-2

EAST JAMB, DOOR FROM STAIR TOWER TO ROOM 1

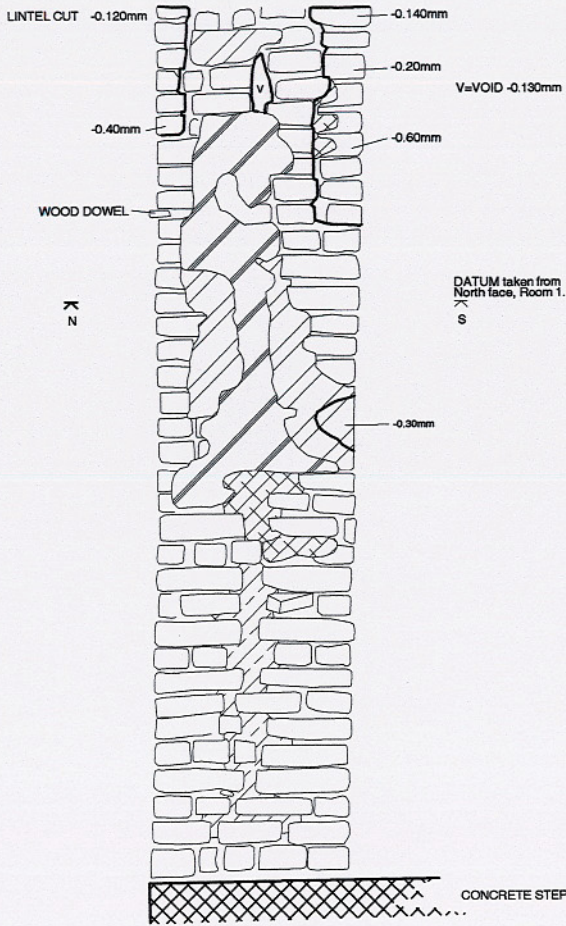

WEST JAMB, DOOR FROM STAIR TOWER TO ROOM 1

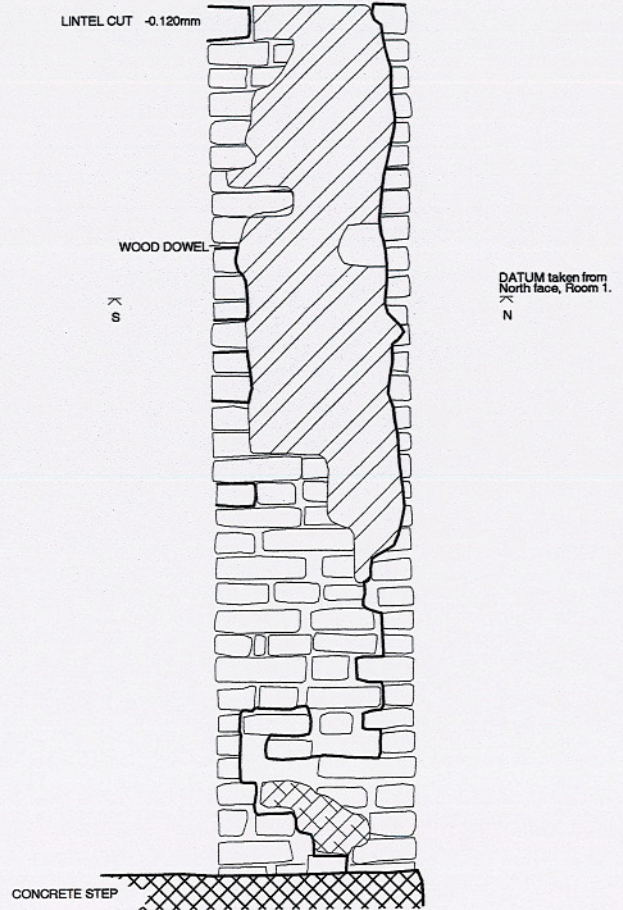

EAST JAMB, DOOR FROM STAIR TOWER TO ROOM 1

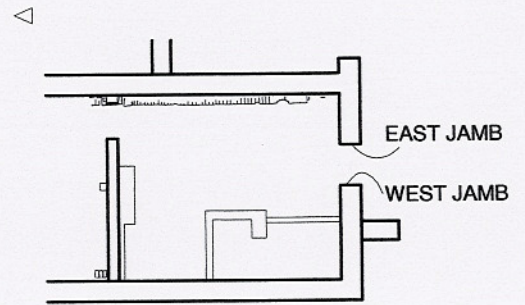
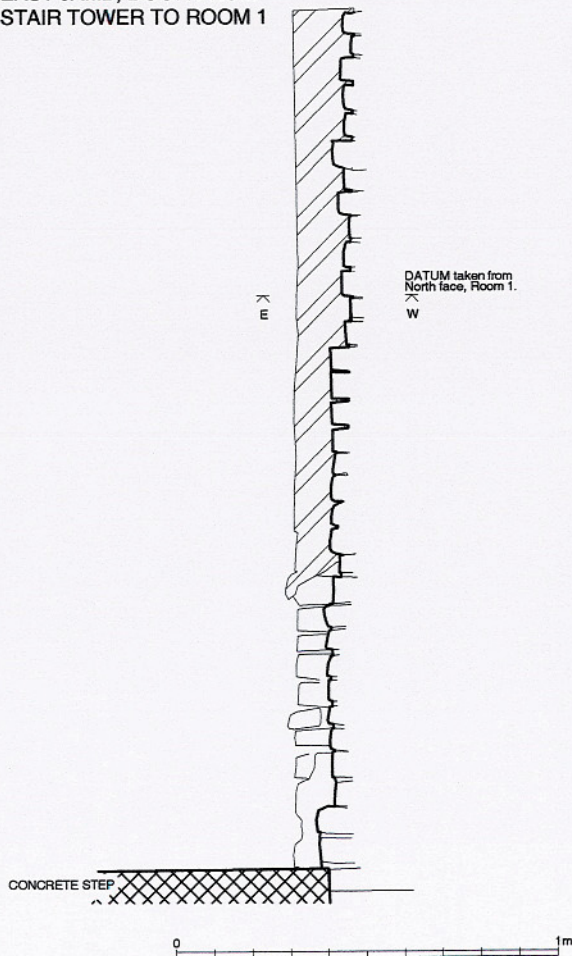





-  MODERN HARD PLASTER.
-  OLD WHITE CRUMBLY PLASTER.
-  MODERN CEMENT.
-  BROWN MORTAR.

Fig 6.



Plate 1, Spoil heap from the stone chamber in Room 2 during excavation.

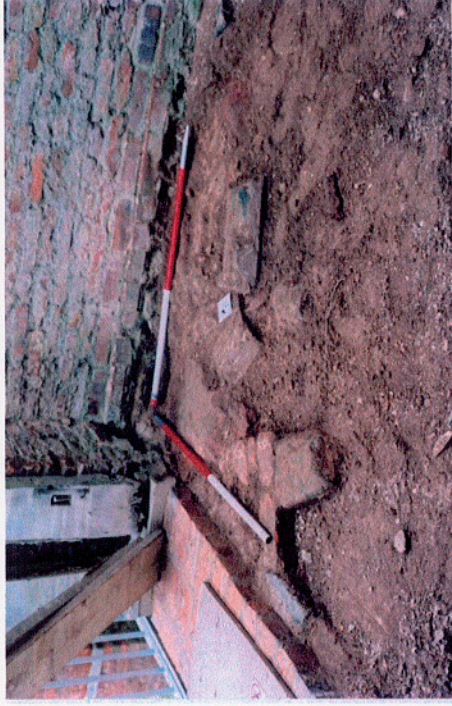

Plate 2, Stones below the earth floor in the N-W corner of Room 1.



Plate 3, Broken 17th c. lintel from below the earth floor in Room 1 (Small Find 1).



Plate 4, Broken 17th c. lintel and two other stones from below the earth floor in Room 1 (Small Finds 2, 8 and 9).

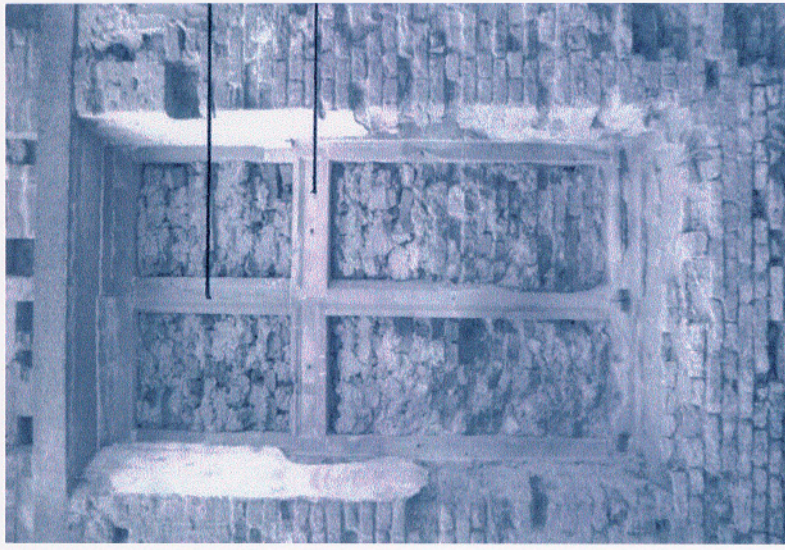

Plate 5, Blocked 17th century window in the main entrance hall.



Plate 6, Broken 18th/19th c. baluster base from the floor of Room 3 (Small Find 7).



Plate 7, Broken baluster base (Small Find 7) viewed from below, shows lozenge cut into the base and cut back edge.

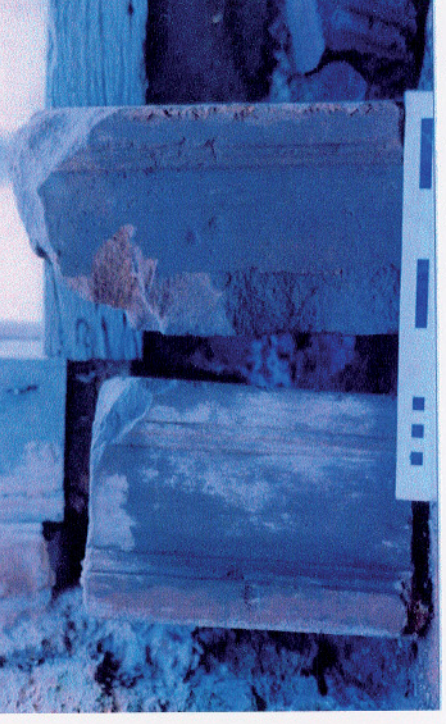

Plate 8, Broken 17th c. transom/mullion pieces from below the floor in Room 4 (Small Finds 3 and 4).



Plate 10, Broken 18th or 19th c. Bath stone moulding, and 19th c. broken fire brick (Small Finds 5 and 6) from Room 4.



Plate 12, Room 4, ledge along the west wall re-using 17th c. transom/mullions.



Plate 13, Moulded timber re-used as a lintel from the doorway between Rooms 1 and 2 (showing the good side).

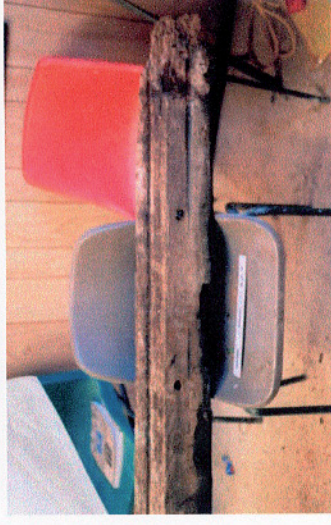

Plate 14, Moulded timber re-used as a lintel from the doorway between Rooms 1 and 2 (showing the good side).

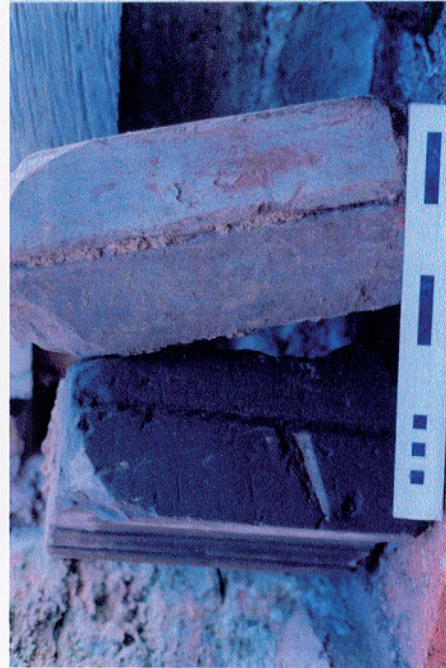

Plate 9, 17th c. Transom/mullion pieces from Room 4, Small Finds 3 and 4, showing glazing slots and paint.



Plate 15, Doorway between Room 1 and the stair tower, unblocked.