



FRICKLEY COLLIERY, AIR RAID SHELTER

South Elmsall,
West Yorkshire

Archaeological Fabric Survey



Oxford Archaeology North

July 2004

**The Environment
Partnership and English
Partnerships**

Issue No: 2004-05/277
OA North Job No: L9337
NGR: SE 4657 0994

Document Title: FRICKLEY COLLIERY AIR RAID SHELTER,
SOUTH ELMSALL, WEST YORKSHIRE

Document Type: Archaeological Fabric Survey

Client Name: The Environment Partnership and English Partnerships

Issue Number: 2004-5/277

OA Job Number: L9337

National Grid Reference: SE 4657 0994

Prepared by: Chris Wild Andy Bates
Position: Project Officer Supervisor
Date: July 2004

Checked by: Jamie Quartermaine Signed.....
Position: Project Manager
Date: July 2004

Approved by: Alan Lupton Signed.....
Position: Operations Manager
Date: July 2004

Document File Location X:\Jamie\PROJECTS\L9337frick2\report

Oxford Archaeology North

Storey Institute
Meeting House Lane
Lancaster
LA1 1TF
t: (0044) 01524 848666
f: (0044) 01524 848606

w: www.oxfordarch.co.uk
e: info@oxfordarch.co.uk

© Oxford Archaeological Unit Ltd 2004

Janus House
Osney Mead
Oxford
OX2 0EA
t: (0044) 01865 263800
f: (0044) 01865 793496

Oxford Archaeological Unit Limited is a Registered Charity No: 285627

Disclaimer:

This document has been prepared for the titled project or named part thereof and should not be relied upon or used for any other project without an independent check being carried out as to its suitability and prior written authority of Oxford Archaeology being obtained. Oxford Archaeology accepts no responsibility or liability for the consequences of this document being used for a purpose other than the purposes for which it was commissioned. Any person/party using or relying on the document for such other purposes agrees, and will by such use or reliance be taken to confirm their agreement to indemnify Oxford Archaeology for all loss or damage resulting therefrom. Oxford Archaeology accepts no responsibility or liability for this document to any party other than the person/party by whom it was commissioned.

CONTENTS

SUMMARY	2
ACKNOWLEDGEMENTS.....	3
1. INTRODUCTION	4
1.1 Circumstances of the Project	4
1.2 Site Location and Topography.....	4
1.3 Historical Background	5
1.4 Previous Work Undertaken at the Site.....	7
2. METHODOLOGY.....	8
2.1 Documentary Search.....	8
2.2 Oral Survey	8
2.3 Fabric Survey	8
2.4 Photographic Survey.....	10
2.5 Archive.....	9
3. RESULTS.....	11
3.1 Documentary Search.....	11
3.2 Oral Survey Results	11
3.3 General Description	11
3.4 Detailed Description	13
4. CONCLUSION.....	14
4.1 Discussion.....	15
4.2 Conclusion	166
4.3 Recommendations.....	16
5. BIBLIOGRAPHY	18
5.1 Published Cartographic Sources	18
5.2 Primary Sources.....	18
5.3 Secondary Sources.....	18
APPENDIX 1:	20
Project Brief	
APPENDIX 2:	200
Tunnel Descriptions	
ILLUSTRATIONS	26
List of Figures	
List of Plates	

SUMMARY

A fabric survey was undertaken in April and June 2004 of a Second World War air raid shelter at Frickley Colliery, South Elmsall, West Yorkshire (NGR SE 4657 0994), by Oxford Archaeology North (OA North). This was undertaken following, and was informed by, a desk-based assessment of the colliery site (OA North 2003) and its associated air raid shelter, in response to a planning proposal by The Environment Practice (TEP) for the landscaping and enhancement of the derelict industrial site.

The desk-based assessment was completed by OA North in July 2003, revealing that Frickley Colliery was established by the Carlton Main Colliery Company in March 1903, and that by 1908, a total of 1133 men were employed at Frickley Colliery, of which 899 toiled below ground and 234 worked on the surface. By 1918, these figures had increased to 1523 men below ground and 431 on the surface. The output of the colliery increased, and by 1945, covering the period when the air raid shelter was operational, 2232 men were employed below ground and 540 on the surface.

In 1954, Frickley Colliery produced over one million tons of coal, retaining its status as one of the largest producers in Yorkshire. Production eventually ceased on 26th November 1993, and the colliery closed. No mention of the air raid shelter was found within the archives.

The air raid shelter comprised a series of connected tunnels, extending across an area measuring 77m by 44m, and was oriented approximately north-west/south-east. It has three main parallel tunnels, with shorter connecting tunnels, originally probably in excess of 310m in extent. Approximately 300m of tunnel survive intact, with damage at its greatest in the south-east corner. The structure is of an arched-type concrete construction, formed around a timber frame within a slit trench.

The presence of pairs of doors within the entrances into the tunnels, appear to be associated with an air-lock procedure, to stop gas from the surface entering the shelter complex. The discovery of an *in-situ* ladder in an alcove within the tunnels suggests that several of the alcoves may have served as further emergency exits. A toilet seat observed within another of the alcoves suggests that some housed chemical toilets.

The Frickley Colliery air raid shelter is of both local and regional importance, and apart from the damage sustained during the present programme of development on this site, and the loss of the south-eastern section, it is in relatively good condition. However, given the rapid manner of its construction and the fact that it has been part flooded for extended periods in the past, it is recognised that some sections of tunnel have the potential for collapse; for this reason there are concerns about the safety of the complex. It has therefore been agreed that part of the complex will be demolished to allow for the residential development, and that the south-eastern section will be retained, subject to sufficient engineering works to make the tunnels safe. It is recommended that an archaeological watching brief be undertaken during any demolition, which would also allow for the mapping of the ends of the tunnels in the north-western part of the complex should any remains survive at tunnel base level.

ACKNOWLEDGEMENTS

Oxford Archaeology North would like to thank The Environment Practice (TEP) and English Partnerships for commissioning the work. Oxford archaeology North would also like to thank the staff of Carl Bro, in particular Mike Philips, Ritchie Aitchison and Tim Morley, for their support, for the provision of the project infrastructure and for help with the health and safety aspects of the project. Thanks are due to David Clarke at the Coal Authority Mining Records Office for assistance with the documentary search. We would also thank the staff of Ian Farmers, who provided all the plant machinery.

The initial survey was undertaken by Andy Bates and Christina Robinson, and the following fabric survey by Chris Wild and Andrew Lane. The report was compiled by Andy Bates and Chris Wild, with the CAD drawings produced by Chris Wild and Emma Carter. Jamie Quartermaine and Alan Lupton edited the report and the project was managed by Jamie Quartermaine.

1. INTRODUCTION

1.1 CIRCUMSTANCES OF THE PROJECT

- 1.1.1 In response to a proposal for the landscaping and enhancement of the derelict industrial site of Frickley Colliery, South Elmsall, West Yorkshire (Fig 1), the Environment Partnership, on behalf of English Partnerships, commissioned Oxford Archaeology North (OA North) to undertake an archaeological assessment of the site (OA North 2003). This assessment identified a Second World War air raid shelter (SE 4657 0994) in the north-western part of the site, which was within an area that was proposed to be developed as residential housing. In response to concerns expressed by members of the local community about the preservation of this shelter, English Partnerships and Wakefield Municipal District Council (MDC) undertook to investigate the structure further and to provide a mitigative record of the shelter should all or part of the structure be demolished.
- 1.1.2 A specification was prepared by West Yorkshire Archaeology Service Advisory Service and this was adapted by OA North to fit the specific needs of the recording programme (*Appendix 1*). Once this was approved OA North was commissioned to undertake the work. The recording work entailed the provision of additional documentary work to establish the history of the air raid shelter. An oral survey to establish information pertaining to the establishment of the shelter, a fabric survey to provide a metric record of the air raid shelter and finally a photographic record of the shelters. This report sets out the results of the various surveys, conducted between April and June of 2004.

1.2 SITE LOCATION AND TOPOGRAPHY

- 1.2.1 Frickley Colliery (NGR SE 464 097) lies in the southern part of South Elmsall township, and is situated some 15km east of Barnsley and 15km north-west of Doncaster, within the modern county of West Yorkshire (Fig 1). The settlements of South Elmsall and South Kirkby are situated to the north and north-west respectively, whilst Frickley lies to the south.
- 1.2.2 The solid geology to the east of the site is Southern Magnesian Limestone overlain by thin glacial drift, with Coal Measures in the west (Countryside Commission 1998, 64-5). The Coal Measures are made up of mudstone with beds of sandstone and many seams of coal. The limestone deposits of the area have been exploited as a building material for many centuries, with a resulting large number of small quarries occurring throughout the region.
- 1.2.3 The landscape of the region is dominated by two escarpments, which stretch from Bedale in North Yorkshire down to Nottingham. These escarpments form a quite narrow ridge and, in combination with well-drained soils and low altitude, have created a landscape of rolling landform and fertile farmland (*op cit*). This is contrasted sharply with the industrial settlements that have evolved around the numerous collieries in the area.

1.3 HISTORICAL BACKGROUND

- 1.3.1 A detailed historical account of the area is presented in the desk-based assessment of the site (OA North 2003) and it is not intended to replicate this. Below, however, is presented a brief history of the colliery, within which the Air raid shelter was constructed.
- 1.3.2 Frickley Colliery was established by the Carlton Main Colliery Company in March 1903, when two 23ft diameter, brick-lined shafts were sunk with the intention of exploiting the rich deposits of coal within the Barnsley Seam (Hill 2001, 198), which was already being mined at South Kirkby. The 9ft 6in thick Barnsley Seam was reached at a depth of 668 yards in May 1905, and the first coal gained from the colliery was dispatched by rail to Grimsby during September 1905.
- 1.3.3 The Ordnance Survey map of 1907 (surveyed in 1904) shows a large reservoir to have been constructed immediately to the north of the colliery, and approximately ten buildings to have been erected around the heapstead area (ie around the mouth of the winding shaft). These buildings included a wagon shop, blacksmiths and fitting shops, and a powerhouse. The blacksmiths shop was a common feature of collieries, and played a vital role in their running. It was responsible for general smithy work, including tasks involving forging and heat treatment processes, together with the capping and recapping of ropes. The powerhouse was also an important building, and provided an electric supply to the colliery from 1906 onwards, and soon supplied other collieries in the area with power, including Grimethorpe, Brierley, Ferrymoor and South Elmsall (*ibid*). A network of railway lines, extending eastwards from the colliery, also appear on the 1907 edition map, representing the initial part of the Frickley Branch line.
- 1.3.4 In 1911, the Warde Adlam Hospital was opened, having been built next to the colliery due to the great distance of the nearest hospital from the site (*ibid*). In 1918 a brick-making plant was also under construction at the colliery, although its precise location is not clear.
- 1.3.5 During the initial years of operation, the No 1 shaft operated as the downcast and coal winding shaft, whilst No 2 shaft was used principally for winding men, materials, and spoil (*ibid*). However, as the output increased, both shafts were employed to raise coal. The expansion of output was linked to an expansion of the workforce; in 1908, a total of 1133 men were employed at Frickley Colliery, of which 899 toiled below ground, and 234 worked on the surface. By 1918, these figures increased to 1523 men below ground and 431 on the surface.
- 1.3.6 The Ordnance Survey 25” to 1 mile map of 1918 (surveyed in 1914) provides a detailed plan of the colliery, and demonstrates the expansion of the site since the previous edition Ordnance Survey map of 1907 (surveyed in 1904). Whilst there appears to have been some additions to the buildings within the heapstead area by 1914, the most striking expansion was in terms of the number of railway sidings, and the completion of the Frickley Branch Line railway to the main Hull and Barnsley Railway line. Located to the north of the colliery, a short row of buildings also appear, which are likely to be miner’s cottages.
- 1.3.7 The Ordnance Survey map of 1932, surveyed in 1929/30, shows the colliery infrastructure to have remained largely similar to the layout depicted on the 1918 edition, although there were some notable additions. In particular, the appearance of a huge spoil heap to the east of the heapstead, which was served by an aerial

ropeway, illustrates a high level of productivity. Small additions to the complex of railway sidings appear to have been made, whilst to the south of the sidings, a number of new sludge beds are shown. These will have received the water that had been used to wash the coal. In general terms, a requirement to wash the coal coincided with the working of dirty or inferior coal seams (Wilson nd).

- 1.3.8 An annual report for the year ending in March 1930, produced by the Carlton Main Colliery Company (DDWN/A10/60), states that some 18 million tons of coal had been extracted from Frickley Colliery since its commencement, and average daily output was then 5,700 tons. This had been extracted entirely from the Barnsley Seam. The document also implies, however, that the colliery was not working at full production, due to the depressed condition of the coal trade.
- 1.3.9 Coal was mined entirely by hand at Frickley until 1934, when mechanical conveyors were introduced. These were evidently a successful innovation, as face-conveyors were installed throughout the mine by 1937 (Hill 2001). In 1942, the Dunsil Seam, located at a depth of 680 yards, was opened via drifts from the Barnsley Seam. The output of the colliery increased accordingly, and by 1945, 2232 men were employed below ground and 540 on the surface.
- 1.3.10 ***Air Raid Shelter:*** only a limited amount of documentary information was available for the Second World War (1939-1945) air-raid shelter, reflecting that typically these monuments were constructed in a period when productivity and economy of production were of the essence and documentation was a lesser priority. A rapid examination of the site conducted as part of the desk-based assessment (OA North 2003) revealed it to comprise a series of inter-linking tunnels, buried to a depth a little over 1m below the modern ground surface (Fig 2). It was constructed of wire-reinforced concrete, mixed with brick aggregate (Carl Bro 2003). The shelter acted as a blast-proof shelter for colliery employees and the local residents of South Elmsall.
- 1.3.11 ***Later History of the Colliery:*** the ownership of the colliery was transferred from the Carlton Main Colliery Company to the Government during the nationalisation of the industry in 1947 (Goodchild 2000, 10). At this time, Frickley had the largest output of the collieries in the region, raising 4000–5000 tons per day (Hill 2001, 198). It is thus unsurprising that significant advances in mechanisation were implemented at Frickley Colliery. A significant innovation was the introduction of mechanised extraction in the Dunsil Seam during 1951. The 200 yard-long coal face was equipped with German-type friction props, an armoured conveyor with a double-jib coal cutting machine followed by a fender plough, known as the ‘Currie plough’, named after its inventor who was a foreman fitter at the colliery (*op cit*, 199).
- 1.3.12 In 1954, Frickley Colliery produced over one million tons of coal from the Barnsley and Dunsil Seams, retaining its status as one of the largest producers in Yorkshire. In order to keep pace with increased extraction, skip-winding was introduced into the No 1 shaft in 1964 (Hill 2001). The skips were upgraded to 10 tons capacity in 1965, and to 12 tons capacity subsequently. However, extraction from the Barnsley Seam ceased in 1966 following a major fire caused by spontaneous combustion (*op cit*).
- 1.3.13 In 1968, Frickley and South Elmsall Collieries were combined into a single unit under the control of a General Manager (*op cit*). During the same year, a rapid-

loading, 'merry-go-round' rail system was commissioned, which was one of the first in the country. The bulk of the output at this time, which averaged 30,000 tons of coal per week, was sent to the coal-fired power stations at Ferrybridge and Thorpe Marsh (Hill 2001). In order to ensure that this supply did not suffer through lack of reserves, a pair of drifts were cut to the Cudworth Seam, at a depth of 309 yards; this seam was put into production in 1970.

- 1.3.14 ***Frickley Colliery in Decline:*** by 1984, the mineral railway network had changed and had been considerably reduced. Both the Hull and Barnsley Railway and the Frickley Branch Line had been dismantled, but the mineral railway was still connected to the main railway system via the former Swinton and Knottingly Railway (*ibid*). The aerial ropeway also appears to have been dismantled.
- 1.3.15 On 13th November 1993, the Daily Telegraph reported that '*British Coal yesterday signalled the expected closure of South Yorkshire's previously reprieved Frickley Colliery near Pontefract with the loss of 740 jobs*'. Production ceased on 26th November 1993, and the colliery closed.
- 1.3.16 Following the closure, British Coal dismantled all above ground structures across the site. This was followed by an extensive programme of surface working by Wakefield MDC to win any recyclable or commercially extractable material on the site. The effect was to leave an extensive area of waste ground that was largely devoid of extant surface archaeological remains.

1.4 PREVIOUS WORK UNDERTAKEN AT THE SITE

- 1.4.1 Prior to any work taking place at the site, Wakefield MDC had already removed 1.0m of overburden from the site to expose the extent of the tunnels. Although no archaeological contractors have undertaken work at the site, Carl Bro did complete an investigation into the condition of the air raid shelter (Carl Bro 2003). The methodology for this worked involved limited excavation of areas around the perimeter of the tunnels, and the cutting of eight small inspection or trial holes, approximately 0.20m by 0.20m square, through the roof of the tunnels.
- 1.4.2 A brief description of the shelter from this report describes the tunnels having a slab floor with concrete walls and arched roof. The height to the crown of the arch in 1.9m, with the tunnels measuring 1.01m wide, although subsequent investigation by OA North showed that the tunnels varied from 1.4m to 1.6m wide as measured from their external faces. The roof is described as varying in thickness from 75mm to 125mm. The concrete which forms the walls and roof is of variable quality, but mainly poor, with large sections of tunnel constructed from crushed brick aggregate. The concrete was reinforced with a wire mesh 6mm in diameter, although no reinforcing mesh, was located in any of the eight trial holes.
- 1.4.3 The report concluded that there was a significant risk of collapse of the tunnels, a supposition reinforced by the fact that parts of the structure have already fallen in; however, some of these areas may have collapsed when the tops were cleared using heavy machinery by Wakefield MDC.

2. METHODOLOGY

2.1 DOCUMENTARY SEARCH

2.1.1 **Coal Authority Mining Records Office:** the Coal Authority Mining Records Office was consulted for plans relating to Frickley Colliery. Specifically, plans were sought for the below ground air raid shelter which formed part of the colliery complex. The Mining Records Office holds all known below ground plans for the colliery, as well as abandonment plans giving details of buildings on the surface.

2.2 ORAL SURVEY

2.2.1 An oral survey was undertaken, initially contacting a co-ordinator from Groundwork Wakefield (Chris Dickinson) who provided details of individuals who may be able to contribute to the survey. The head of the Frickley Colliery Development Group (Barry Wilshaw) was contacted and also a former employee of the colliery (Terry Wilshaw), who as an inspector had the responsibility for checking the safety of the air raid shelter. While he only had knowledge of the air raid shelter in the 1970s and 1980s he kindly offered to make contact with members of the local community who may have further information about the shelter, particularly pertaining to its Second World War construction and use. This process will, however, take some weeks and therefore the survey has yet to be completed.

2.3 FABRIC SURVEY

2.3.1 The work was carried out in two phases, an initial survey of the outline of the tunnels, to produce an accurate plan of their shape and location, followed by a fabric survey of the shelter. The top of the shelter had already been exposed by Wakefield District Council prior to the commencement of work at site.

2.3.2 **Initial Survey:** an initial survey was undertaken with a Zeiss Elta 3 total station, using a pen computer to capture the data within AutoCad R14, which recorded those parts of the tunnels that were exposed on the surface. Prior to the survey the crowns of the tunnels on the surface were evident but, for the most part, the tunnel edges were not. It was, therefore, necessary to clean back and expose those edges of the tunnels on the outside of the complex using a JCB mechanical excavator. Because of concerns about the condition of the tunnels, it was not possible for the same machine to drive over the tunnels, and it could not, therefore, be used to expose the tunnel edges on the inside of the complex. In the event a smaller two ton 360° tracked mechanical excavator was used, which was able to cross the tunnels using a temporary bridge. This was created using spoil built up on either side of the tunnel and a steel plate between the mounds, consequently no pressure was placed on the tunnels which may have resulted in the weakening of their structural integrity or possible collapse. The results of this survey was a plan showing the external layout of the tunnels superimposed upon a base topographic survey of the area provided by Carl Bro.

- 2.3.3 **Internal Survey:** the survey of the interior of the tunnels was severely complicated by health and safety constraints. As it was unsafe to enter the tunnels, a specialised survey methodology had to be employed. Ten, approximately 5m length, sections of the tunnel roof were removed at key locations, under archaeological supervision. Two further apertures were opened at the brick-blocked entrance and at the collapsed end of the tunnel spur to the south (Fig 2).
- 2.3.4 Following appropriate gas monitoring and other safety procedures, a survey of the interior was undertaken from these positions, using a reflectorless total station, to produce an accurate internal plan, without the need of entry into the tunnels. The internal base plan was superimposed onto the external plan to provide a comprehensive record of the structure. There were localised areas where it was not possible to survey the internal wall faces from the limited number of survey stations, in these areas, the internal face was extrapolated from the external faces of the tunnel. In addition to the ground plans, several cross sections were surveyed using the reflectorless instrument, and these are presented as Fig 4. A series of elevations was also surveyed along three faces of the tunnels (Fig 5).
- 2.3.5 **Analysis:** a general descriptive record was also undertaken of the tunnels, corresponding to the Royal Commission on Historic Buildings in England (RCHM(E)) Level II-type survey. This level of recording is descriptive and produced an analysis of the development and use of the building.

2.4 PHOTOGRAPHIC SURVEY

- 2.4.1 A detailed photographic record was undertaken of the tunnels using medium format black and white prints, 35mm colour slide and black and white and in a digital format. The black and white photography was taken using a silver-based film (FP4). General external images of the tunnels were taken in all formats showing the tunnel tops and the wider context of the air raid shelter.
- 2.4.2 A photographic record of the tunnel interiors was also undertaken using a medium format camera to produce black and white prints, accompanied by digital colour photography. Thirty five millimetre black and white and selected colour slide photographs were also taken.
- 2.4.3 Where possible the photographs were taken perpendicular to the line of the tunnels. Given the difficulties of taking photographs within a dark tunnel a combination of techniques were used in order to record the tunnel interiors. The most successful technique was to combine the use of displaced flash gun behind the camera looking towards an opening with natural illumination. In the event it was found that there was sufficient background light to enable the alignment of the camera, and it proved possible to take photographs correctly aligned down the tunnels; it was not therefore necessary to use Archis software to correct the alignment of the images. Selective internal photographs were taken of significant detail showing the method of construction, together with general shots of areas of space as well as detailed shots of surviving original internal fixtures, including light fittings and toilet areas.
- 2.4.4 Ranging rods were set parallel to the line of the tunnels as far as was possible. They were thrown down the tunnels and retrieved using an attached piece of string, and in some cases this did provide for some deviation away from a parallel alignment.

2.4.6 Prints were produced at 5" x 7" and 10"x 8" sizes and a photographic register detailed the location and direction of shot. The position and direction of the photographs is depicted on the ground plans.

2.5 ARCHIVE

2.5.1 A full archive of the fabric survey has been produced to a professional standard in accordance with current English Heritage guidelines (English Heritage 1991). The project archive was compiled in accordance with United Kingdom Institute for Conservation guidelines (UKIC 1990). The paper and digital archive will be deposited in the West Yorkshire Archives in Wakefield on completion of the project. A copy of the report will be deposited with the West Yorkshire Archives SMR in Wakefield.

3. SURVEY RESULTS

3.1 DOCUMENTARY SEARCH

- 3.1.1 ***Coal Authority Mining Records Office:*** a search of the below ground plans and the surface abandonment plans for Frickley Colliery revealed no trace of the air raid shelter. It is likely that the shelter did not appear on the surface plans since it was below ground. Similarly, it is probable that the shelter did not appear on the plans of the workings because it was at no great depth, and did not directly relate to the coal being mined. Staff at OA North were advised by the Coal Authority that they were not aware of any possible repositories for records from Frickley Colliery other than the Coal Authority Mining Records Office.

3.2 ORAL SURVEY RESULTS

- 3.2.1 The oral survey is still in progress, as contact with individuals who remember the Second World War period of use of the air raid shelter is being attempted; at present, however, little information is available for this period. The lack of information about the Second World War period is a reflection of the fact that many of those who would have had knowledge about the site then are now deceased, or are no longer available. The shelter was regularly inspected by Terry Wilshaw, Inspector for Frickley Colliery (pers comm), before being sealed in 1986. He reports that the tunnels formerly continued some distance to the east of the present observed limits, and that there was a similar air raid shelter at South Kirkby, about two miles to the west, which was believed to have been built in 1937. There was relatively little bombing in the Frickley area during the War and the nearest site to have received a direct hit was Upton, which is two miles from the Frickley Colliery site; it is thus possible that there was little need for the site to be used as an air raid shelter during the War.

3.3 GENERAL DESCRIPTION

- 3.3.1 ***Introduction:*** described below is the general form and construction of the tunnels, a more detailed description of the more significant features is presented in *Section 3.3*. The tunnels are numbered with respect to a series of primary east/west tunnels (Tunnels A, B and C) and their corresponding off shoots and are labelled on Figure 3. Descriptions of these individual tunnels are presented in *Appendix 2*.
- 3.3.2 ***The form of the Air Raid Shelter:*** the shelter comprised a series of connected tunnels, measuring 77m by 44m within an area of *c* 1400m² (Fig 2; Plate 1). It was oriented approximately north-west/south-east, and had three main tunnels on this alignment, with shorter connecting tunnels and a rectilinear area of tunnels to the south-east. A length of 300m of tunnel survive intact, with the original extent in excess of 310m. The complex sloped to the south-east corner, where damage was at its greatest, probably as a result of severe flooding that had been observed in this section.

- 3.3.3 The air raid shelter complex is of arched gallery design, constructed within slit trenches. Upon excavation of the trenches, timber formwork was erected, and concrete was poured to form the walls and arched roof (Figs 4 and 5). The excavated earth was then used as a covering for the shelter, to provide additional protection and camouflage. The initial inspection and outline survey of the site revealed that the concrete structure had previously been buried beneath *c* 1m of earth (Carl Bro 2003, 1). This was a fairly standard design for air raid shelters of the period (Johnson 2004), which typically had a series of narrow tunnels, rather than larger chambers, because of the greater strength of the slit trench tunnel and because they were quicker and cheaper to construct. The emphasis of the design was clearly its functionality and security rather than comfort for the occupants.
- 3.3.4 The complex appears to have had only one entrance, located in the north-west corner (Plate 2), and a single escape tower, which was subsequently concrete capped (Plate 3), located towards the south-eastern end (Fig 3). The tunnels vary in size, from 0.96m wide, to 1.03m wide, and 1.75m to 2.02m in height. The thickness of concrete used was also variable (Carl Bro 2003, 3), as was the shape of the top of the arches (Fig 3), which appear to have been only roughly finished. Within each tunnel were several alcoves, typically 1.02m wide and 1.20m deep. In total 36 such features were located (with at least one further destroyed in the damaged section), and there appears to be no pattern in their distribution, either in terms of their spacing, or on which side of the tunnel they were located (Fig 3).
- 3.3.5 **Plan Layout:** the surviving remains of the air raid shelter reveals a series of parallel tunnels (Tunnels A, B and C), of which two (Tunnels A and B) converge on the main entrance at the west end of the complex. In between these are a series of interconnecting tunnels (Tunnels A1, A2, B1, B2, B3 and B4. Extending to the south of Tunnel C was a series of three rectangular tunnel outlines (Tunnels D, D1, D2, E1, E2, E3 and F1) which were evidently a central part of the original design as the connecting tunnels from Tunnel B, were obliquely connected to this core of three outlined rectangles. The air raid shelter clearly only part survives as there are fractured ends to Tunnels B, B3, D2 and F1, that indicate that it formerly extended to the south-east.
- 3.3.6 The concrete used to build the shelter was of poor quality, with high percentages (*c*20%) of brick and rubble aggregates, and varying degrees of steel re-inforcement bars. A detailed description of the concrete fabric was previously undertaken by Carl Bro (*op cit*, 5) which revealed that the concrete was of variable consistency and quality. In those areas where a 20mm stone aggregate was used, the strength was comparable to modern standards of concrete. A Schmidt Hammer strength test was applied to the concrete and gave readings of 30N/mm² as compared to strengths of 35N/mm² which is typical for modern concrete. However, where brick aggregate has been used the strength of the concrete drops to 17.5N/mm² which is considerably below modern day standards (*ibid*). There were variable amounts of steel reinforcement which used 6mm bars at 150mm centres, and was of either mild or high yield steel (*ibid*). Evidence of the construction technique was observed throughout the tunnels in the form of striations in the concrete walls and arched roof (Plate 4), which represent the positions of the individual timber boards forming the frame into which the concrete was poured. These appear to have been generally 0.28m wide.

3.4 DETAILED DESCRIPTION

- 3.4.1 Whilst the majority of the tunnels appeared empty, or backfilled with rubble, several features were observed.
- 3.4.2 **Entrance:** concrete steps to the west of the shelter lead down to entrance to the tunnel complex (Tunnel A) (Fig 3). Removal of a single-skin brick stopping revealed an entrance lobby approximately 2.2m². There was no evidence for an external door to this lobby, but typically these air raid shelters would have been fitted with an iron blast proof door (Johnson 2004), and it is to be presumed that this was removed for scrap when the air raid shelter became redundant and the surround was lost, possibly at the same time, when the brick blocking was constructed. From the lobby, tunnels lead to the east and south-east. Each tunnel had a doorway at the entrance (Fig 4; Plates 5 and 6), and a further doorway 2.75m into the tunnel (no safe access was possible to locate the inner doorway of the south-eastern tunnel). These areas, in between the two pairs of internal doors, would have served as airlocks in the event of a possible gas attack (*ibid*). Elements of all the door frames survived, demonstrating that these were wooden doors, with timber shuttering to the arch crowns above. Unfortunately no evidence of signage survived within the lobby.
- 3.4.3 **Escape Hatches:** the location of the inspection holes (Fig 3) did not allow for the recording of the escape tower (off Tunnel E3), recorded by the previous survey (Carl bro 2003, 2), which suggested that nothing remained within the tower prior to it being concrete capped. However, excavation of Inspection Hole **10** in Tunnel C (Fig 2), revealed an *in-situ* metal ladder within an alcove (Figs 3 and 5; Plate 7). The base of the ladder, which was badly damaged (Plate 8), was attached to the concrete floor, demonstrating that the ladder had been fixed in this position, rather than being deposited during backfilling. The discovery of this feature suggests that more of the alcoves may have functioned as escape hatches. Escape hatches were a standard feature of these air raid shelters, which commonly had only a single entrance and, therefore, provided for an alternative exit in the event of the entrance being blocked by rubble (Johnson 2004). These were typically located at some distance from the entrance in the hope that any collapse affecting the entrance did not also block the escape hatch.
- 3.4.4 **Alcoves:** extending out from the walls of the tunnel were at least 36 alcoves, internally 0.8m x 0.95m in size, which extended up to the roof of the tunnel. Undoubtedly, some of these were for toilet cubicles, typically with chemical bucket toilets with wooden seats (Johnson 2004), and several wooden toilet seats were observed within areas of backfill/collapse. Whilst these may have been deposited from demolished surface structures during backfilling, the presence of a similar seat on the floor of an alcove on the west side of Tunnel D2 (Fig 3; Plate 12), suggests they may all relate to the shelter. Toilet seats of what appears to be an identical style, were observed in a large air raid shelter in Plymouth, forming part of Elsan chemical toilets (Johnson nd). There are, however, more alcoves than would have been required to provide toilet facilities, and one at least was intended to allow for emergency access as evidenced by the fixed ladder in an alcove to the north of Tunnel C.
- 3.4.5 **Fittings:** throughout the tunnels, hooks for carrying festoon lighting were observed near the tops of the tunnel walls. It appears that each tunnel had a row of electric

lights down one side, supported on metal hooks, hammered into wooden dowels, which were inserted into holes drilled into the concrete walls (Plate 9).

- 3.4.6 To the west of Inspection Hole 6 (Tunnel B) (Fig 3), three round metal bars were observed, set into the walls across the tunnel, just below wall-head height. They were unevenly spaced and were not level across the tunnel (Plate 10), making their function unclear. The floor below was heavily silted, but had a fabric/rubber matting cover, below which was further structural metal-work (Plate 11). This comprised two 5' (1.52m) long rails, each having an open cylindrical section, with a rounded hook-rail on the outer side. The rails appear to be joined by two or three cross-braces. Further c50mm diameter rails, observed in the silt on the tunnel floor, appear to have originally fitted inside the larger rails. The purpose of the structure is unclear.

4. CONCLUSION

4.1 DISCUSSION

- 4.1.1 The survey has revealed the well-preserved remains of the Frickley Colliery air raid shelter. Approximately 300m of tunnels survive, with the only serious damage in the south-eastern and south-western corners. While both the physical and the oral evidence confirm that the shelter formerly extended to the south-east of the present limits, it is unclear how far it extended.
- 4.1.2 The structure is of arched-type concrete construction, formed around a timber frame within a slit trench. This appears to be one of the two standard methods of construction, the other, square design, comprising pre-fabricated concrete panels with a flat roof, as observed at MOD West Freugh, Stranraer (OA North 2004). The layout of the tunnels into ‘galleries’ was common, as it reduced the damage from a direct hit (Johnson, nd), but the reason for the peculiar tunnel arrangement at Frickley remains unclear. In particular, it is unclear why the southern section of the complex is rectilinear, whilst the northern part has a herring-bone layout.
- 4.1.3 The initial inspection of the air raid complex (Carl Bro 2003), revealed a single entrance and emergency exit into the tunnel complex. This would appear to be inadequate for a complex comprising in excess of 300m of tunnels; however, is not unusual (Johnson 2004). Individual elements of the shelter would be unlikely to withstand a direct hit, collapsing and blocking parts of the tunnel. However, the galleried layout of the tunnels meant that the only parts of the complex that could not be bypassed was the spur to the south of Inspection Hole 12 (Tunnel B4); this would therefore allow sufficient access to exit around a blockage. The air raid shelter was in any case deliberately sited away from standing buildings, so that in the event of an air raid the collapse of an adjacent building would not also collapse the shelter or block the entrances. The discovery of an *in-situ* ladder in an alcove within Inspection Hole 10, suggests that several of the alcoves may have served as further emergency exits, particularly in the isolated spurs. The bent remains of the ladder are longer than the tunnel height, strongly suggesting that it reached surface level. It remains unclear whether the alcove originally had a concrete shaft to the surface, as does the surviving example, or whether it had more temporary metal sheet or timber sides above the tunnel to the surface.
- 4.1.4 There was an expectancy of gas-shell attack and reducing the numbers of entrances would have reduced the opportunity for gas to penetrate the shelter. The presence of pairs of doors within the entrances into the tunnels from the main lobby in the north-west corner, appear to be associated with an air-lock procedure, to stop gas from the surface entering the shelter complex. The toilet seat observed within another of the alcoves suggests that some of the other alcoves housed chemical toilets. Local knowledge had previously suggested that the toilets only comprised basic fire buckets.
- 4.1.5 The nature of the concrete and construction method are both crude; the concrete contains large quantities of brick and pebble aggregates, making it weak in places, whilst the internal surfaces of the tunnels are uneven, showing that the shuttering boards were not always aligned properly during construction. Both are relatively important features, reflecting the economic and political climate at the time of

construction, most probably in the first years of WWII (1939 or 1940). Raw materials were highly valuable at this time, and appear to have been diluted to the minimum acceptable standard with aggregate in order to extend their coverage. The simple design and entirely functional construction of the tunnels most probably reflects the speed at which it was built, using the minimum manpower, and may also reflect a shortage of skilled labour, brought about by the war.

- 4.1.6 **Construction Date:** the precise construction date of the air raid shelter is unknown. Air raid shelters started to be constructed some years before the war, following the passing of the Air Raid Precautions Act in 1937. Thereafter, air raid shelter construction was concentrated in areas of greatest population density and to serve vital command units and personnel, such as the Cabinet War Rooms in Whitehall (Lowry 2004, 36). The main period of air raid construction was in 1939 and 1940 in response to the start of German air raids and the anticipated invasion of Britain. The constructional form of the Frickley air raid shelter reveals that it was poorly finished and had concrete in places comprising brick aggregate which had a corresponding affect upon the strength of the shelter. This reflects that the shelter was of rushed construction and probably put up during a period of considerable pressure; as such this may suggest that it was built in the period 1939-1940 when there was an immense impetus to rapidly construct civil defences.

4.2 CONCLUSION

- 4.2.1 The air raid shelter is an extensive feature and is one of the few surviving elements of one of the most productive collieries in Yorkshire in the mid twentieth century. Little documentary information is available on air raid shelters of this complexity, reflecting that they were built at a time when the priority was construction rather than documentation. Many large shelters were publicly constructed but these were targeted either to schools or residential areas. At the same time larger companies were constructing shelters for their workforce, and the Frickley shelter would clearly fall within this category. There is, however, very little information readily available regarding the provision for air raid shelters at collieries, which were a vital part of the war-time economy, and provided the main source of power for industry. It is also unclear how many industrial shelters, like the one at Frickley, are now preserved. It is noteworthy that no war-related features are included in the Monuments Protection Programme for the Coal Industry (Goulde and Cranstone 1992).
- 4.2.2 The large size of the shelter would easily accommodate the c500 surface workers of the colliery (although only for short periods, as no bunk provisions were incorporated). However, it is not clear whether it was also intended to accommodate the below ground colliery workers. While any below ground workers would be safe from bombing down the mines, they would have been trapped if the head gear was destroyed and there is a possibility that they were also intended to be accommodated within the shelter.
- 4.2.3 A well-documented public shelter in Plymouth had better amenities, such as benches and separate sex toilet areas (Johnson nd). The lack of benches within the shelter may relate its the industrial nature, although it is equally possible that un-fixed benches were used, that were later removed after the war.
- 4.2.4 The Plymouth shelters also contained large quantities of graffiti (Johnson nd), both by adults and children, whilst none was observed during the inspection of the

tunnels at Frickley. This absence of graffiti suggests a lack of use of the shelter, and no records of bombing of the colliery were found in the earlier desk-based assessment (OA North 2003). It is possible that the shelter was never used.

4.3 RECOMMENDATIONS

- 4.3.1 The Frickley Colliery air raid shelter is of local significance, both as a monument to Second World War and as one of the few surviving features relating to the main economic activity for the Frickley community for most of the twentieth century. It is also potentially of some national significance, as an example of a large industrial air raid shelter.
- 4.3.2 The initial inspection of the site (Carl Bro 2003), in conjunction with discussions with members of the local community and West Yorkshire Archaeology Service, recommended that part of the complex be preserved (*op cit*, 6). The results of this investigation support this recommendation. Any proposed *in-situ* preservation should take into account the different tunnel layouts within the complex (rectilinear and herring-bone), and should therefore preferably incorporate parts of both, and ideally include some of the *in-situ* features. Subject to discussions with Carl Bro and English Partnerships it has been agreed that the south-eastern section of the complex should be preserved as this will enable the construction of the residential development to the north-west of the air raid shelter.
- 4.3.3 Due to the unsafe nature of the tunnels, both this survey, and the previous inspection (Carl Bro 2003), have only afforded a partial visual inspection of the air raid shelter complex. It is, therefore, quite possible that important features, for example, graffiti and toilets, remain unrecorded within the complex. The large quantities of silt, particularly towards the eastern end of the complex, may also contain significant finds from the construction or use of the shelter. The attachment footings of further escape ladders, if not the ladders themselves, may also remain *in-situ*, beneath the silt.
- 4.3.4 It is therefore recommended that an archaeological watching brief be undertaken during any demolition, which would also allow for the mapping of the ends of the tunnels in the north-western part of the complex should any remains survive at tunnel base level.

5. BIBLIOGRAPHY

5.1 PUBLISHED CARTOGRAPHIC SOURCES

Ordnance Survey, 1907 (a) *Yorkshire (West Riding) Sheet 263 SE, Second Edition 1907*, surveyed 1849-50, 6": 1 Mile

Ordnance Survey, 1907 (b) *Yorkshire (West Riding) Sheet 264 SW, Second Edition 1907*, surveyed 1849-50, 6": 1 Mile

Ordnance Survey, 1907 (c) *Yorkshire (West Riding) Sheet 275 NE, Second Edition 1907*, surveyed 1849-50, 6": 1 Mile

Ordnance Survey, 1907 (d) *Yorkshire (West Riding) Sheet 276 NW, Second Edition 1907*, surveyed 1850, 6": 1 Mile

Ordnance Survey, 1918 *Yorkshire (West Riding) Sheet 263.16, Edition of 1918*, resurveyed 1891, 25": 1 Mile

Ordnance Survey, 1932a *Yorkshire (West Riding) Sheet 263.16, Edition of 1932*, resurveyed 1891, 25": 1 Mile

Ordnance Survey, 1932b *Yorkshire (West Riding) Sheet 264.13*, resurveyed 1891, 25": 1 Mile

Ordnance Survey, 1932c *Yorkshire (West Riding) Sheet 275 NE, Edition of 1932*, surveyed 1850, 6": 1 Mile

5.2 PRIMARY SOURCES

5.2.1 *Doncaster Archives, Doncaster*

DD/WN/A10/60, nd (1930s) *The Yorkshire Coalfield*

5.3 SECONDARY SOURCES

Carl Bro 2003 *Renaissance South Yorkshire Frickley Colliery: Investigation into the Condition of Air Raid Tunnels*, unpub rep

Countryside Commission, 1998 *Countryside Character Volume 3: Yorkshire and the Humber, the character of England's natural and man-made landscape*, Cheltenham

English Heritage, 1991 *Management of Archaeological Projects*, 2nd edn, London

Goodchild, J, 2000 *Images of England: West Yorkshire Coalfield*, Stroud

Goulde, S, and Cranstone, D, 1992, *Monuments Protection Programme: The Coal Industry, Step 1*, unpubl rep

Hill, A, 2001 *The South Yorkshire Coalfield: A History and Development*, Stroud

Johnson, S nd *Plymouth's World War II Underground Air raid Shelters*, (web page) www.cyber-heritage.co.uk

Johnson, S 2004 *Attack from Above*, (web page) www.geocities.com/Pentagon/Bunker/8453/air.htm

Lowry, B, 2004 *British Home Defences, 1940-45*, Oxford

OA North 2003 *Frickley Colliery, South Elmsall, West Yorkshire: Archaeological Desk-Based Assessment*, unpubl rep

OA North 2004 *MOD West Freugh, Wigtownshire: Archaeological Building Inspection*, unpubl rep

UKIC, 1990 *Guidelines for the Preparation of Archives for Long-Term Storage*

Wilson, FH, nd (pre 1913) *Coal – its origin, method of working, and preparation for market*, London

APPENDIX 1 PROJECT BRIEF

1. Introduction

1.1 A survey is required to record an air raid tunnel at Frickley Colliery in advance of a programme of landscaping of the site. It is anticipated that part of the site will be retained for presentation purposes but, the majority of the site will be destroyed for health and safety reasons.

2. Site Location and Description

The site consists of the former Frickley Colliery, established in 1903, which is to the immediate south of South Elmsall and encompasses 0.8sqkm.

3. Archaeological Interest

3.1 Frickley Colliery became one of the most productive collieries in Yorkshire, and in 1954 produced over 1 million tons of coal. Following the Miners Strike the colliery was reprieved, but then on 13th November 1993 British Coal indicated that the colliery would close and production then ceased on 26th November 1993. Almost immediately the upstanding remains were demolished by British Coal, and Wakefield District Council subsequently undertook extraction across the site to win any commercially retrievable materials. Very little now survives of the colliery remains, although there are occasional foundations visible at ground level. The shafts have been capped and made safe.

A World War II air raid shelter is known to survive the demolition and extraction works, and was an industrial build to accommodate the work force during any bombing raids during the second world war. Little documentary information has been identified of the shelter, but first appears on the 1949 6" to 1 mile OS map. The shelter comprises a series of interlinked tunnels, originally buried to 1m below the ground surface, but its roof is now exposed in places at ground level. The tunnels were made of reinforced concrete incorporating brick aggregate. The concrete was even originally of poor quality and the tunnel roof has collapsed in a number of places. Because of the risk of collapse, there is no safe access into the tunnels.

4. Aims of the Project

4.1 The aim of the proposed work is to make a general photographic and drawn record of the air raid shelter prior to its removal, as well as the preparation of a short report based on readily available records allied to any information that can be obtained from reliable local informants, and from the mining records office for the Coal Authority.

5. Methodology

5.1 The archaeologist on site will naturally operate with due regard for Health and Safety regulations. **Prior to the commencement of any work on site (and preferably prior to the submission of the tender) the archaeological contractor should carry out a Risk Assessment of the proposed works in accordance with the Health and Safety at Work Regulations. WYAS cannot be held responsible for any accidents that may occur to outside contractors engaged to undertake this survey while attempting to conform to this specification.**

5.2 **Prior to commencement of any work**, the archaeological contractor should confirm in writing to the WYAS – Advisory Service adherence to this specification, or state (with reasons) any proposals to vary the specification. Should the contractor wish to vary the specification, then written confirmation of the agreement of the WYAS – Advisory Service is

required prior to work commencing. **Modifications presented in the form of a re-written project design will not be considered by the WYAS Advisory Service.**

5.3 The contractor should provide to the WYAS – Advisory Service a projected timetable for the work on site by the various personnel, i.e. building recorder, photographer. *Curriculum vitae* of key project staff should be supplied to the WYAS – Advisory Service. All staff should be appropriately qualified and experienced for their roles. In particular, staff involved in building recording should have proven expertise in the photographing, recording and analysis of standing buildings.

5.4 The **Recording Work** shall be in four parts:

- Oral / Additional Documentary survey
- photographic recording
- drawn record
- written report

6. Oral / Additional Documentary Survey

6.1 An oral survey will be undertaken of members of the local community to establish the known history of the air raid tunnels, to establish who commissioned their construction and the date when they were built. The results of this study will be incorporated into the final report.

6.2 There is the potential that records of the air raid shelter are retained within the Mining Records Office, of the Coal Authority. The original search for documents from the Coal Authority identified that the archive for Frickley Colliery is of considerable size, and while some pertinent plans relating to the colliery operations were obtained, no particular search was made for documents relating to the air raid shelter. The majority of the records held by the mining office relate to below ground workings. As part of this stage of the programme it is proposed to target a search specifically for the air raid shelter, with the hope of establishing its date of construction, plans, and subsequent usage.

7. Drawn record

7.1 In this instance, a cross-section and internal elevation at 1:50 and a plan at 1:250 are sufficient, with drawings at 1: 50 or 1: 20 (as appropriate) of any details that warrant recording.

7.2 An annotated block plan of the site at 1: 250 will be supplied with the report showing the position of all recorded structures in relation to the OS National Grid.

7.3 Stage 1: OA North will supervise the exposure of the outside of the tunnels, and with a conventional total station will record the exterior of the tunnels as a plan and also as cross sections along selective sections of it. the drain at the south eastern end will be opened, sufficiently to allow the draining of the tunnels, and once the aperture is opened a ceramic drain will be inserted and then the entrance will be backfilled..

7.4 Detailed Method Statement: the tunnel edges will be exposed by mechanical excavator; those outside the complex will be cleared using a JCB wheeled excavator. There will be a need in some areas to gain access within the tunnel system and will entail crossing a tunnel. It is proposed to undertake the excavation with a mini-digger which, because it will be of light weight and will have tracks to minimise the load, will minimise the load on the tunnels. Wooden / steel beams of sufficient strength to take the weight of the mini digger will be set across the tunnels and if necessary a small amount of spoil will be placed on either side of the tunnel to ensure that the beam is raised above the crown of the tunnel. If, despite this, the tunnel collapses there will be no risk to the machine because of the beams, but there will be a need to open out the roof of the tunnel and backfill it.

7.5 Stage 2: at present it is proposed to preserve the southernmost section, but allow for the demolition for the northernmost section. This means that there will be no new disturbance to the section that will be retained but inspection holes will be cut through the roof of those sections that are to be demolished. Access to the interior of the section to be retained will be from the collapsed ends of the tunnels that define the edges of the area.

Carlbro will supervise the cutting and removal of 4m length sections of the tunnel roof at key locations, which should be no more than at 10 locations. The concrete will be cut using a still saw, and then the slab will be lifted off with a mechanical excavator. Where the access holes are within the interior of the complex then the same strategy for getting a machine to the holes will be employed as for Stage 1. The tops of the hole will be cleared of any loose material to ensure that none will fall into the tunnel. If necessary acroprops will be inserted within the sides of the tunnel to ensure that the walls do not collapse.

7.5 OA North will then set up a reflectorless total station inside the tunnel within the 4m sections ensuring that personnel at no time go under an intact section of roof. OA North personnel will have protective clothing to prevent against the risk of Weils Disease, and hard hats at all times. Washing facilities will need to be provided on site to ensure that personnel can wash and change from contaminated clothes once they leave the tunnels.

OA North will then undertake a survey of the interior from these positions using a reflectorless total station, which has a range of 30m and should be sufficient to produce an accurate internal plan. At each set up a cross section will also be produced, and selective localised elevation drawing will be produced. For safety reasons there will need to be a banksman on site to ensure the safety of any person within the tunnels. All staff entering the tunnels will have had Confined Space training.

7.6 On completion each opening will be backfilled sufficient to make safe and prevent access from the public. If at any time the holes need to be left overnight they will be covered with a steel plate.

The product will be a brief report on the archaeological condition and a description of the tunnels, along with a plan of the complex and cross sections at various points along the tunnels. Photographs will be taken with digital, and black and white media.

8. Photographic Recording

8.1 General photographs will be taken of the site with a medium format camera using a tripod; these will be taken from raised ground adjacent to the site and will show the general character of the surface features. This will be taken following the clearance of the tunnel edges. Where possible the photographs will be taken perpendicular to the line of the tunnels. Ranging rods will be set parallel to the line of the tunnels. Other detail photographs will be taken with a Medium Format or a 35mm camera. The photographs will be black-and-white using a silver-based film (FP4), and colour-transparencies.

Internal photography: given the difficulties of taking photographs within a dark, tunnel, it is proposed to use a medium format camera, coupled to a pair of spatially separated flash guns, and then shooting blind into the tunnel. As far as is possible the photographs will be taken on a central alignment down the tunnels, but it is recognised that it will not be possible to produce perfectly aligned photographs in these conditions. Following the field work, the photographs will be digitised and processed within Archis software which will adjust out any deviation from the vertical for the tunnel wall sides.

Ranging rods will be within the photographs, however, as there will not be safe access down the tunnels, it is proposed they be thrown into the tunnel and retrieved using an attached piece of string. The implications are that they will not be perfectly aligned with the tunnel sides.

Prints to be minimum 5" x 7" with a small selection at 10"x 8" black-and-white (the best of the exterior and interior shots). A photographic register detailing (as a minimum) location and direction of shot must accompany the photographic record. Position and direction of *each photograph* should be noted on a copy of the building / site plans, where relevant. In addition

a 35mm **colour-slide general survey of the building** should also be provided (using a variety of wide-angle, medium and long-distance lenses). It is not necessary to duplicate every black-and-white shot, but the record should be comprehensive enough to show the principal elevations of the building with appropriate external and internal detail. **A separate** photographic register should be provided for the colour-slide record. *All* detailed colour-slide photographs, where practical, must contain a graduated photographic scale of appropriate dimensions, though the general shots do not require a ranging pole.

8.2 A **selective internal record** shall be made showing the method of construction, general shots of areas of space (such as an individual gallery) as well as detailed shots of any surviving original internal fixtures and fittings such as blast proof doors, benches and toilet areas, as well as any surviving signage. Previous shelters recorded in a school in West Yorkshire had a plaque on its entrance door. The structure should be examined, if possible, for evidence for the original use of gas curtains (which should be photographed in detail if present)..

9. Unexpectedly Significant or Complex Discoveries

9.1 Should there be, in the professional judgement of the archaeologist on site, unexpectedly significant or complex discoveries made that warrant more detailed recording, than possible within the terms of this specification, then the archaeological contractor is to urgently contact the WYAS Advisory Service with the relevant information to enable the matter to be resolved with the developer.

10. Written Report

10.1 The report should include an introduction outlining the reasons for the survey, and a brief architectural description of the building correlated to the photographic record. The report will include drawings of the plan and cross sections at the point of sampling.

The report should be presented in a logical manner from general shots of the exterior, to the interior of the building. Detailed captions should accompany high quality laser copies of **ALL** photographic prints, bound into the report (which should be referred to by number in the text) to aid our understanding of the buildings use and function. **N.B.** contractors should use a running sequence of numbers i.e. photo no.1, no.2, no.3 etc to identify the individual photographs (also to be marked up on a location map/ floor plans showing the direction of shot) rather than the film-and-frame number. The film-and-frame number should be included in brackets at the end of the detailed caption for each shot.

10.2 A copy of this specification should be bound into the rear of the report.

11. Post-Recording Work and Report Preparation

11.1 The Field Archive: A fully indexed field archive should be compiled consisting of all primary written documents, plans, photographic negatives and a set of suitably labelled contact sheets (only). The field archive should be deposited with the Wakefield Office of the West Yorkshire Archive Service (Registry of Deeds, Newstead Road, Wakefield, WF1 2DE Tel 01924 305980), and should be accompanied by a covering letter detailing the deposit location of the full report and photographs.

11.2 **The Photographic Record for the SMR:** labelled photographic prints. Labelling should be in indelible ink or preferably on printed label on the *back* of the print and should include:

- film and frame number;
- date recorded and photographer's name;
- name and address of building;
- national grid reference (NGR)

Photographic prints should be mounted in appropriate archival stable sleeves and presented in a manila soft-backed folder, **not a hard-backed ring-binder**, so as to ensure that it can be housed in a filing-cabinet. A quantified index to the field archive should be deposited with the West Yorkshire SMR. Colour-slides should be mounted, marked with the township name in capitals (South Elmsall), the name of the building (under), the national grid reference (at the bottom), with date of photograph on the right-hand side of the mount and the contractor on the left-hand side. The slides should be hung in an appropriate conservation-quality slide-hanger (for a filing-cabinet).

11.3 Contractors are also required to fill in a separate **Summary Sheet** (copy provided) to be returned to the WYAS Advisory Service for inclusion in the summary of archaeological work in West Yorkshire to be published biannually by that office within '*Archaeology & Archives in West Yorkshire*'.

11.4 A minimum of **three copies** of the report should be supplied: one for the client, one for the Local Planning Authority (Wakefield District Council), and one first to be supplied to the WYAS Advisory Service for its written approval.

11.5 The photographic **prints** (presented separately), and **slides**, should be sent to the WYAS – Advisory Service as soon as is practical, but not later than one calendar month after receipt of the report. The finished report should be supplied within a maximum period of eight weeks of completion of the fieldwork, unless otherwise agreed with the WYAS Advisory Service. The information content of the report will become publicly accessible once deposited with the WYAS Advisory Service. **N.B.** the planning condition will not be recommended for discharge UNTIL the completed record, the report photographs and slides, have all been received by this Service, and they have been checked and deemed acceptable and a letter to that effect has been written to the local planning department.

12. General Considerations

12.1 Any technical queries arising from this specification should be addressed to the WYAS Advisory Service without delay.

12.2 It should be noted that this specification is based upon records available in the County Sites and Monuments Record and on a brief examination of the site by the WYAS Advisory Service. Archaeological contractors submitting tenders should carry out an inspection of the site prior to submission. If, on first visiting the site or at any time during the course of the recording exercise, it appears in the archaeologist's professional judgement that

- i) a part or the whole of the site is not amenable to recording as detailed above, and/or
- ii) an alternative approach may be more appropriate or likely to produce more informative results, and/or
- iii) any features which should be recorded, as having a bearing on the interpretation of the structure, have been omitted from the specification,

then it is expected that the archaeologist will contact the WYAS Advisory Service as a matter of urgency. If contractors have not yet been appointed, any variations which the WYAS Advisory Service considers to be justifiable on archaeological grounds will be incorporated into a revised specification, which will then be re-issued to the developer for redistribution to the tendering contractors. If an appointment has already been made and site work is ongoing, the WYAS Advisory Service will resolve the matter in liaison with the developer and the Local Planning Authority.

12.3 It is the archaeological contractor's responsibility to ensure that they have obtained the WYAS Advisory Service's consent in writing to any variation of the specification prior to the commencement of on-site work or (where applicable) prior to the finalisation of the tender. Unauthorised variations may result in the WYAS Advisory Service being unable to recommend discharge of the archaeological recording condition to the Local Planning Authority and are made solely at the risk of the contractor.

12.4 This exercise will be monitored as necessary and practicable by the WYAS Advisory Service in its role as 'curator' of the county's archaeology. The Advisory Service should receive at least one week's notice in writing of the intention to start fieldwork. A copy of the contractor's Risk Assessment should accompany this notification.

12.5 The WYAS Advisory Service will wish to know of the successful processing of the films by the submission of a set of contact sheets to the SMR, taken as a result of this specification, **before the removal of the shelter can commence**. This Service will then write to the applicant's agent with copy to the LA of its satisfaction of the primary record being made, this will release the building for development to commence.

West Yorkshire Archaeology Service – Advisory Service

Oxford Archaeology North

May 2004

WEST YORKSHIRE ARCHAEOLOGY SERVICE

TELEPHONE: (01924) 305178

Registry of Deeds

Fax: (01924) 306810

Newstead Road

Wakefield

e-mail: isanderson@wyjs.org.uk

WF1 2DE

This specification is valid for a period of one year from date of issue. After that time it may need to be revised to take into account new discoveries, changes in policy or the introduction of new working practices or techniques.

APPENDIX 2

TUNNEL DESCRIPTIONS

Tunnel No **A**
Inspection Holes 1, 2, 3 and 4
No of Alcoves 3
Orientation North-west/south-east
Dimensions Length 48.6m Height 2.0m

The northernmost of the tunnels which extends out from the entrance portico and has an airlock at its western end. Concrete steps to the west of the shelter lead down to entrance to the tunnel complex at the west end of Tunnel A. Removal of a single-skin brick stopping revealed an entrance lobby approximately 2.2m². There was no evidence for an external door to this lobby. The air lock comprises a pair of door frames 2.85m apart which have timber shuttering extending above the frame to the roof of the tunnel. A substantial section of the tunnel has collapsed at Inspection Hole 1, and the floor is here covered in rubble. Generally though the floor has silt cover and has pools of water at the eastern end but otherwise is relatively clear of debris.

Tunnel No **A1**
Inspection Holes 2
No of Alcoves 1
Orientation North-east/south-west
Dimensions Length 8.7m Height 2.14m

A short interconnecting tunnel between Tunnels A and B. It is in good condition, and has only a limited build up of silt on the floor.

Tunnel No **A2**
Inspection Holes 3
No of Alcoves 1
Orientation North-north-west/south-south-east
Dimensions Length 10.6m Height 1.93m

A short interconnecting tunnel between Tunnels A and B. It is in good condition, and has only a limited build up of silt on the floor.

Tunnel No **B**
Inspection Holes 4, 5, 6 and 7
No of Alcoves 4
Orientation North-west/south-east
Dimensions Length 73m Height 1.97m

The central link tunnels which extends out from the entrance portico and has an airlock at its western end. The air lock comprises a pair of door frames 2.3m apart which have timber shuttering extending above the frame to the roof of the tunnel. A series of interconnecting tunnels extend out from this tunnel linking in to the others of the complex. At Hole 7 is an exposed alcove which is featureless, but has silt build up on the floor. At Hole 5 the tunnel continues but is to the east blocked by collapse. At Hole 6, in the central part of the tunnel, there are three iron bars crossing the tunnel at roof height. The floor below was heavily silted, but had a fabric/rubber matting cover, below which was further structural metal-work. This comprised two 5' (1.52m) long rails, each having an open cylindrical section, with a rounded hook-rail on the outer side. The rails appear to be joined by two or three cross-braces. Further c50mm diameter rails, observed in the silt on the tunnel floor, appear to have originally fitted inside the larger rails.

Tunnel No **B1**
Inspection Holes 6
No of Alcoves 1
Orientation North-east/south-west

Dimensions Length 8.5m Height 1.9m

A short interconnecting tunnel between Tunnels B and C. It is in good condition, and has a moderate build up of silt on the floor.

Tunnel No **B2**

Inspection Holes 9

No of Alcoves 1

Orientation North-east/south-west

Dimensions Length 9.0m Height 1.57m

A short interconnecting tunnel between Tunnels B and C; it extends into Tunnel E3. It is in good condition, and has a limited build up of silt and standing water on the floor.

Tunnel No **B3**

Inspection Holes 5 and 8

No of Alcoves 2

Orientation North-east/south-west

Dimensions Length 21.7m Height 1.6m

An interconnecting tunnel between Tunnels B and F2, at its southern end the tunnel has been lost and it terminates in collapse. Generally it is in good condition, and has a limited build up of silt and standing water on the floor. At its southern end there is a substantial build up of water.

Tunnel No **B4**

Inspection Holes 12

No of Alcoves 1

Orientation North/south

Dimensions Length 7.7m Height 1.96m

Tunnel B4 is a short off shoot tunnel from Tunnel B. Originally suggested as being a secondary entrance, but there is no evidence for this. It terminates at its southern end. There is a substantial amount of collapse at the southern end, but elsewhere the tunnel is in moderate condition.

Tunnel No **C**

Inspection Holes 7, 9, and 10

No of Alcoves 5

Orientation North-west/south-east

Dimensions Length 36.2m Height 2.0m

A long tunnel that is parallel to Tunnel B and extends out from it. It has a series of interconnecting tunnels with Tunnel B and Tunnels D2, E1 and E3 extend south from it. At Hole **10** was an *in-situ* metal ladder within an alcove. The base of the ladder, which was badly damaged, was attached to the concrete floor, demonstrating that the ladder had been fixed in this position, rather than being deposited during backfilling. At its western end a large pipe extended along the floor and extended west into an alcove. The pipe has been secured in position by concrete poured over it. It was almost certainly a later addition, possibly to drain the tunnels. In general the tunnel is in good condition, with limited silt build up on the floor.

Tunnel No **D1**

Inspection Holes 11

No of Alcoves 1

Orientation North-west/south-east

Dimensions Length 7.7m Height 1.97m

A short tunnel between Tunnels D2 and E1. It is in relatively good condition, and has a pool of water across the floor.

Tunnel No **D2**
Inspection Holes 11
No of Alcoves 3
Orientation North-north-east/south-south-west
Dimensions Length 15.2m Height 1.94m

A short tunnel between Tunnels C and D1. It is in relatively good condition, and has a build up of silt on the floor. For a short section of tunnel it has a large number of alcoves (3).

Tunnel No **E1**
Inspection Holes 10
No of Alcoves 3
Orientation North-north-east/south-south-west
Dimensions Length 18m Height 1.92m

A tunnel extending between Tunnels C and E2 (the latter was not observed and therefore not described). It is in relatively good condition, and has a pool of water on the floor. There is a small amount of collapse at its northern end.

Tunnel No **E3**
Inspection Holes 9
No of Alcoves 3
Orientation North-north-east/south-south-west
Dimensions Length 18.7m Height 1.87m

A tunnel extending south from Tunnel B2 to Tunnel E2. Two tunnels (F1 and F2) extend east from it but these were not observed and therefore not described). There is a substantial amount of collapse at its northern end which has extended out from the escape tower. Consequently little could be observed of the tower from inside the tunnel. Because of the collapse little could be seen of the southern part of the tunnel.

ILLUSTRATIONS

LIST OF FIGURES

- Figure 1: Location Map
- Figure 2: Frickley Colliery Air Raid Shelter Location Map
- Figure 3: Plan of Frickley Colliery Air Raid Shelter
- Figure 4: Tunnel Profiles
- Figure 5: Tunnel Elevations

LIST OF PLATES

- Plate 1: General view of the air raid shelter from the north-west
- Plate 2: Entrance to the air raid shelter (Tunnel A1)
- Plate 3: View from the east, showing the escape tower on Tunnel E3
- Plate 4: Tunnel C interior, showing construction markings
- Plate 5: Tunnel A from the surface, facing west
- Plate 6: Blocked tunnel B3, looking south
- Plate 7: Ladder within Tunnel C alcove
- Plate 8: Base of ladder (Tunnel C)
- Plate 9: Hook for lighting festoon (Tunnel B)
- Plate 10: Toilet seat in alcove (Tunnel D2)
- Plate 11: Longest tunnel (Tunnel B), looking west
- Plate 12: Undisturbed silt and pipe, looking south-west (Tunnel B1).
- Plate 13: Railings within tunnel silt (Tunnel B)



based upon the Ordnance Survey 1:10000
 with the permission of the controller of HMSO
 © Crown Copyright



Figure 1: Location Map

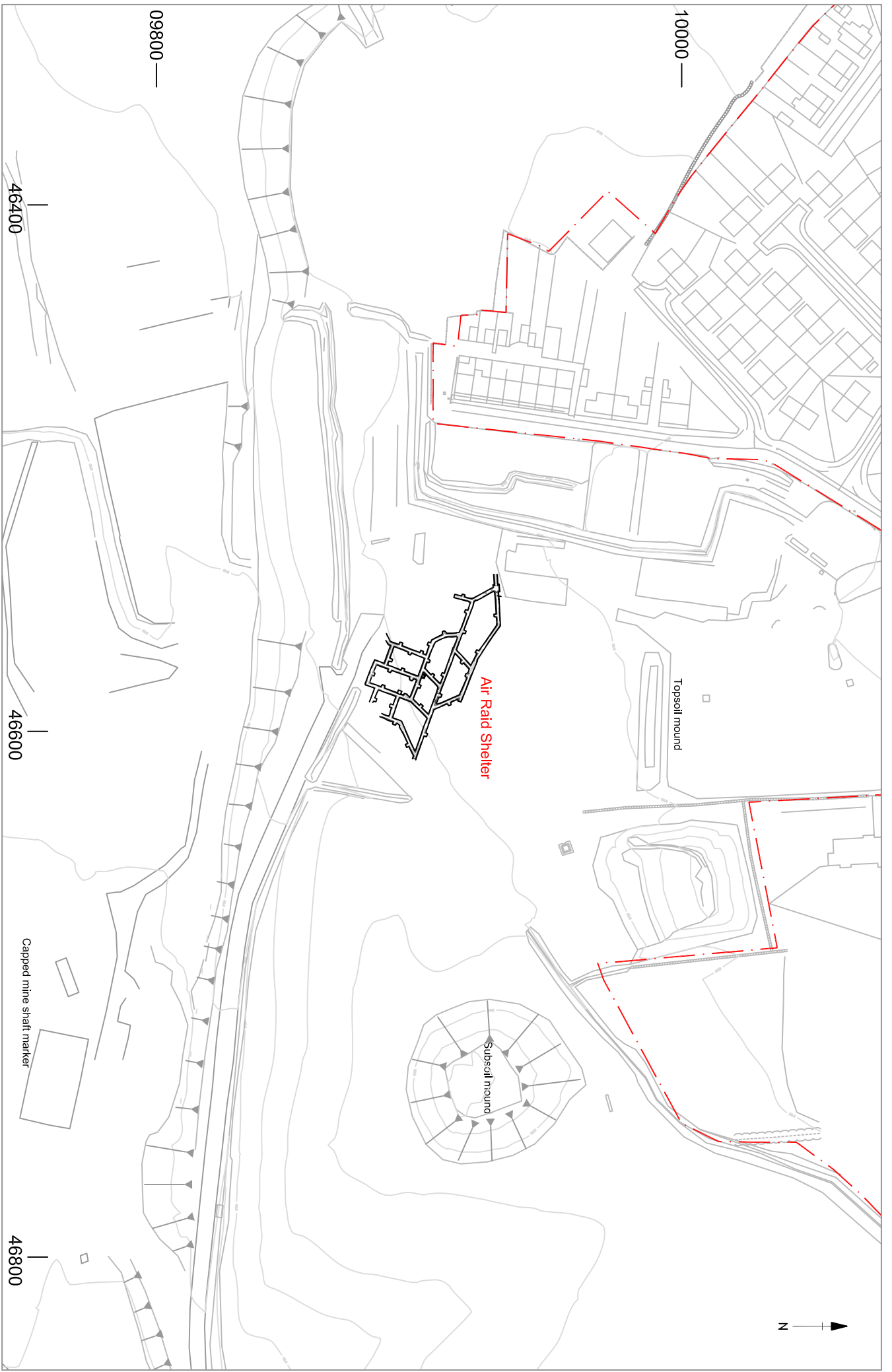



— · · — Extent of Colliery



0 50m
Scale 1:2000 at A4

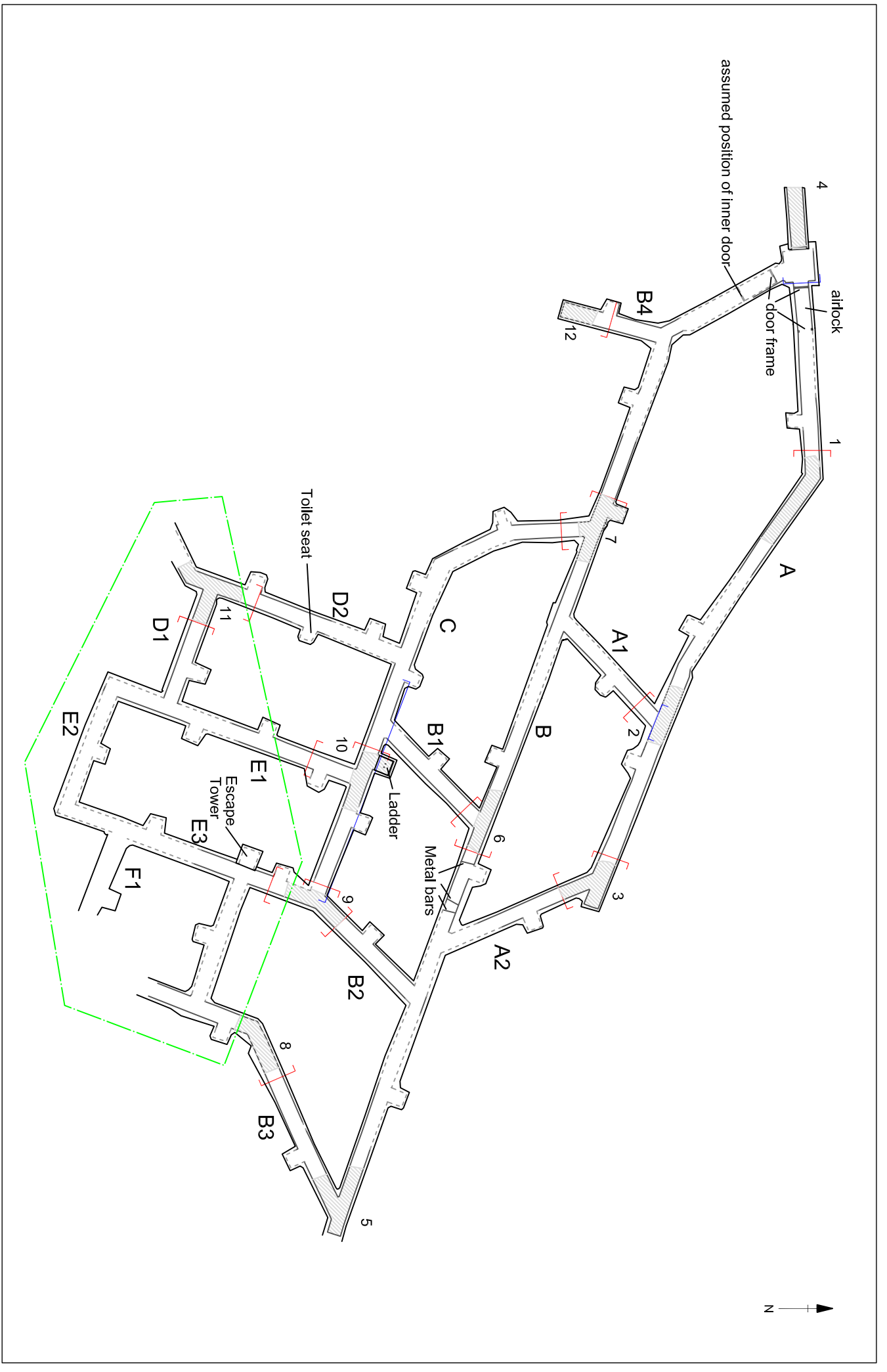

Figure 2: Frickley Colliery Air Raid Shelter Location Map



 Location of excavated interventions
 Location of profiles shown on Figure 4

 Location of elevations shown on Figure 5
 Proposed extent of preservation for the tunnels

0 10m
 Scale 1:350 at A4



Figure 3: Plan of Frickley Colliery Colliery Air Raid Shelter

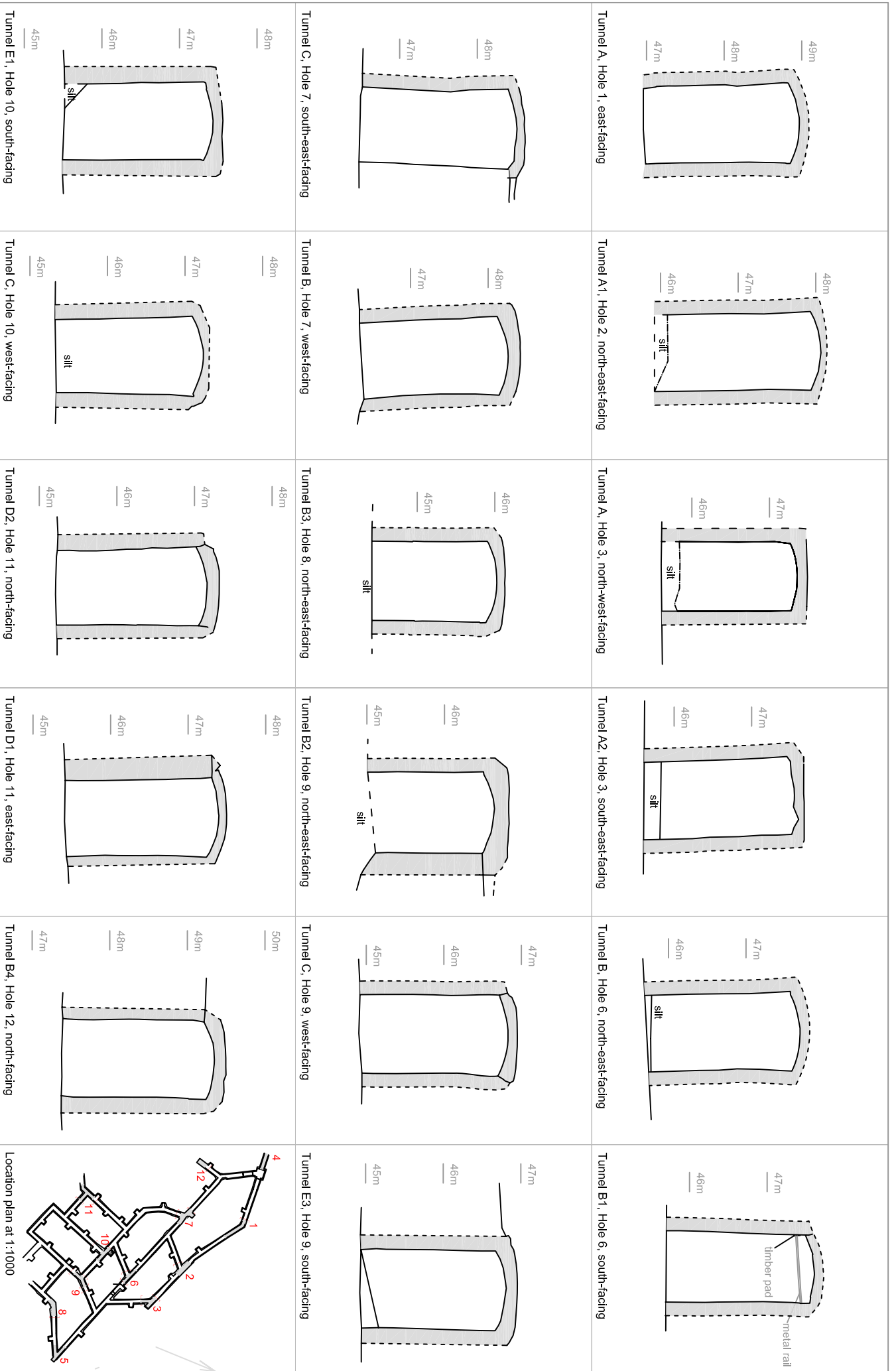

Scale 1:50



Figure 4 : Tunnel Profiles

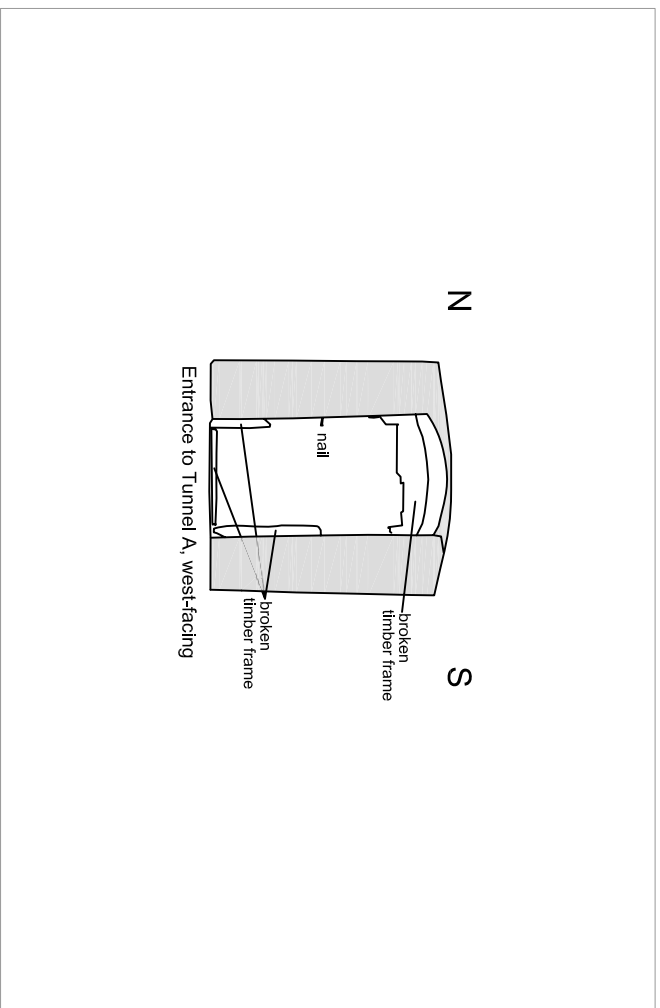
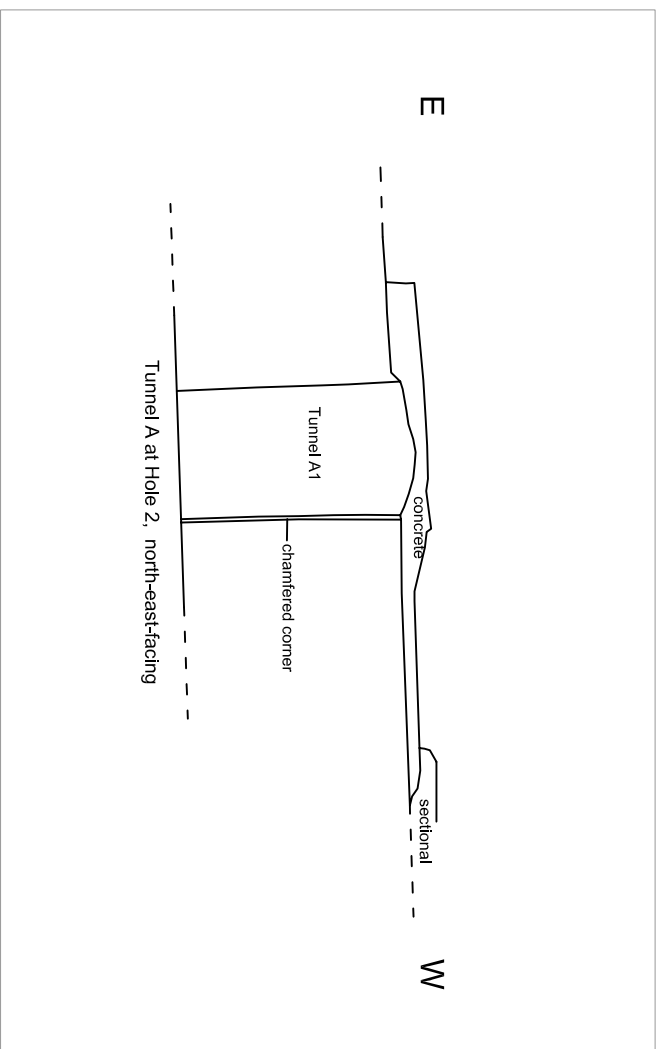
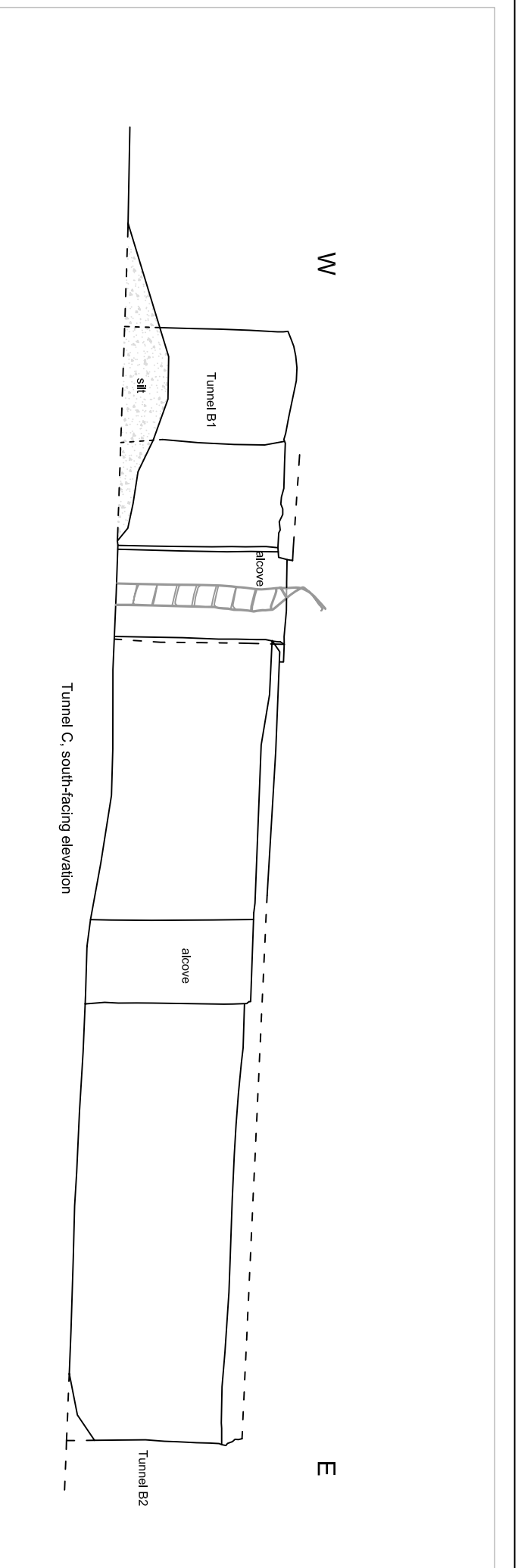

Scale 1:50



Figure 5: Tunnel Elevations



Plate 1: General view of the air raid shelter from the north-west



Plate 2: Entrance to the air raid shelter (Tunnel A1)



Plate 3: View from the east, showing the escape tower on Tunnel E3



Plate 4: Tunnel C interior, showing construction markings (Tunnel C)



Plate 5: Tunnel A from the surface, facing west



Plate 6: Blocked tunnel B3, looking south



Plate 7: Ladder within Tunnel C alcove



Plate 8: Base of ladder (Tunnel C)



Plate 9: Hook for lighting festoon (Tunnel B)



Plate 10: Toilet seat in alcove (Tunnel D)



Plate 11: Longest tunnel (Tunnel B), looking west



Plate 12: Undisturbed silt and pipe, looking south-west (Tunnel B1)



Plate 13: Railings within tunnel silt (Tunnel B)