

**The Orchard
Well Street
Loddiswell, Devon**
Archaeological Evaluation



for
Luscombe Maye

CA Project: 880281
CA Report: 18081

April 2018



The Orchard
Well Street, Loddiswell
Devon

Archaeological Evaluation

CA Project: 800821
CA Report: 18081



Document Control Grid						
Revision	Date	Author	Checked by	Status	Reasons for revision	Approved by
A	23 March 2018	Christina Tapply	Paul Clarke	Internal Revision	–	Derek Evans
B	11 April 2018	Christina Tapply	Paul Clarke	Final	Approved by Stephen Reed	Derek Evans

This report is confidential to the client. Cotswold Archaeology accepts no responsibility or liability to any third party to whom this report, or any part of it, is made known. Any such party relies upon this report entirely at their own risk. No part of this report may be reproduced by any means without permission.

CONTENTS

SUMMARY	2
1. INTRODUCTION	3
2. ARCHAEOLOGICAL BACKGROUND	4
3. AIMS AND OBJECTIVES	4
4. METHODOLOGY	4
5. RESULTS	5
6. THE FINDS	6
7. DISCUSSION.....	6
8. CA PROJECT TEAM.....	7
9. REFERENCES	7
APPENDIX A: CONTEXT DESCRIPTIONS	8
APPENDIX B: OASIS REPORT FORM	10

LIST OF ILLUSTRATIONS

- Fig. 1 Site location plan (1:25,000)
 Fig. 2 Trench location plan (1:250)
 Fig. 3 Trench 1, sections and photographs (1:20)
 Fig. 4 Trench 2, sections and photographs (1:20)
 Fig. 5 Trench 3, photographs



SUMMARY

Project Name:	The Orchard
Location:	Well Street, Loddiswell, Devon
NGR:	272060 048565
Type:	Evaluation
Date:	6 February 2018
Planning Reference:	2078/17FUL
Location of Archive:	N/A
Site Code:	OWS18

In February 2018, Cotswold Archaeology carried out an archaeological evaluation at the Orchard, Well Street, Loddiswell, Devon. A total of three trenches were excavated in the northern part of the site.

A total of five shallow ditches were excavated and recorded, one linear included one sherd of post-medieval pottery. It is likely that these formed a drainage system.



1. INTRODUCTION

- 1.1 In February 2018, Cotswold Archaeology (CA) carried out an archaeological evaluation for Luscombe Maye at the Orchard, Well Street, Loddiswell, Devon (centred at 272060 048565; Fig.1).
- 1.2 The evaluation results will inform a planning application (ref: 2078/17/FUL) made to South Hams District Council for the development of a four-bedroomed residential dwelling with garage and associated landscaping. The scope of this evaluation was defined by Steve Reed, Senior Historic Environment Officer, Devon County Council Historic Environment Team (DCCHET). The results of this evaluation will help to plan the nature and scope of any mitigation.
- 1.3 The scope of this evaluation was defined in discussions with the Devon County Council Historic Environment Team (DCCHET; the archaeological advisors to SHDC). The evaluation was carried out in line with a Written Scheme of Investigation (WSI) produced by CA (2018) and approved by DCCHET. The evaluation was also in accordance with *Specification for Archaeological Evaluation* (DCCHET 2016), *Standard and guidance for archaeological field evaluation* (CIfA 2014), *Management of Research Projects in the Historic Environment (MoRPHE) PPN 3: Archaeological Excavation* (Historic England 2015) and *Management of Research Projects in the Historic Environment (MoRPHE): Project Manager's Guide* (Historic England 2015).

The site

- 1.4 The proposed development site is situated within the north-eastern part of Loddiswell. It is bounded by Fore Street to the west, by Well Street to the north, by gardens to the east, and by an agricultural plot and residential properties to the south and south-west. A spring is located adjacent to the site's eastern boundary. The site encloses approximately 0.2ha and is currently occupied by a former orchard.
- 1.5 The site lies on a steep gradient, at a maximum of 83.9m above Ordnance Datum (aOD) in the north-west and a minimum of 69.5m AOD in the east, sloping towards the springhead of a minor tributary of the River Avon to the south.

- 1.6 The underlying bedrock geology of the site is mapped as Meadfoot Group slate, siltstone and sandstone, which formed in the Devonian Period. No superficial deposits are recorded (BGS 2018).

2. ARCHAEOLOGICAL BACKGROUND

- 2.1 The proposed development site lies within the historic core of Loddiswell. The village is recorded in the Domesday Book (1086) as *Lodeswilla* (Open Domesday 2018), indicating that it had a pre-Conquest origin. Adjacent to the eastern boundary of the site is the spring known as *Lod's Well*, which gave its name to the village.
- 2.2 The earliest detailed map of the proposed development site is the Tithe Map of 1840. This and later cartographic sources show the site as a plot of undeveloped land.

3. AIMS AND OBJECTIVES

- 3.1 The objectives of the evaluation were to provide further information about the likely archaeological resource within the site, including its presence/absence, character, extent, date, integrity, state of preservation and quality. This information will enable DCCHEM to identify and assess the particular significance of any archaeological heritage assets within the site, consider the impact of the proposed development upon that significance and, if appropriate, develop strategies to avoid or minimise conflict between heritage asset conservation and the development proposal, in line with the National Planning Policy Framework (DCLG 2012).

4. METHODOLOGY

- 4.1 The evaluation fieldwork comprised the excavation of three trenches (Fig. 2). The locations of these trenches were altered from those set out in the WSI (CA 2018) due to the steep gradient of the site and to avoid overhead cables and buried services.. Tr1 was 12m long, Tr2 was 9m long and Tr3 was 5m long; all trenches were 1.8m width. The trenches were located to provide a representative sample of the proposed development footprint.
- 4.2 Trenches were set out on OS National Grid (NGR) co-ordinates using Leica GPS and surveyed in accordance with *CA Technical Manual 4: Survey Manual*.

4.3 All trenches were excavated by a mechanical excavator equipped with a toothless grading bucket. All machine excavation was undertaken under constant archaeological supervision to the top of the natural substrate. Where archaeological deposits were encountered they were excavated by hand in accordance with CA Technical Manual 1: *Fieldwork Recording Manual*.

4.4 As no significant archaeological features were identified during the archaeological evaluation, no project archive will be prepared. The results of the fieldwork will be held by DCCHET in the form of this report and the creation of an entry on the OASIS online database of archaeological projects in Britain (as detailed in Appendix B; to include an uploaded copy of this report).

5. RESULTS

5.1 This section provides an overview of the evaluation results. Figure 2 shows the recorded archaeological trenches and features in plan; Figures 3-5 show individual trenches and sections in detail. Detailed summaries of the recorded contexts can be found in Appendix A.

General stratigraphy

5.2 The natural geological substrate was exposed 0.6m–0.9m below the present ground level (bpgl) and comprised clayey silt with frequent pockets of sandstone. It was sealed by 0.2m–0.4m of clayey silt subsoil, which was covered in turn by 0.25m–0.4m of modern topsoil.

5.3 Tr3 contained no archaeological features and is not discussed further.

Trenches 1 and 2

5.4 Natural substrate 102/202 was exposed 0.6m bpgl and was cut by a series of shallow ditches.

5.5 East/west aligned ditch 103 (Fig. 3, Sec. AA) was 1.1m wide and 0.3m deep, with a single undated fill (104).



- 5.6 North/south aligned ditch 203 (Fig. 4, Sec. DD) was 0.95m wide and 0.35m deep, with a single undated fill (204).
- 5.7 North/south aligned ditch 107/207 (Fig. 3, Sec. CC and Fig. 4. Sec. EE) survived to a maximum width of 1.3m and a depth of 0.42m. It contained a single undated fill (108/208). This ditch terminated within Tr1, and was truncated by later ditch 105/205 (see below).
- 5.8 North-east/south-west aligned ditch 209 (Fig. 4, Sec. EE) was 0.25m wide and 0.18m deep. It contained a single undated fill (210) and was truncated by later ditch 105/205 (see below).
- 5.9 North/south aligned ditch 105/205 (Fig. 3, Sec. BB and Fig. 4. Sec. EE) terminated within Tr1. This ditch was 1.08m wide and 0.3m deep, and contained a single fill (106/206), from which one sherd of post medieval pottery was recovered. Ditch (105/205) truncated ditches 107/207 and 209.

6. THE FINDS

- 6.1 One sherd of pottery was recovered from context 206 (fill of ditch 205). This was of mid 16th–mid 18th century glazed earthenware from the north Devon (Barnstaple) industry, or potentially from Donyatt, Somerset.

7. DISCUSSION

- 7.1 The evaluation recorded five shallow ditches at the site. These ditches are all on perpendicular alignments to the extant field boundaries. Ditch 105/205 contained a sherd of post-medieval pottery, but the other ditches were undated artefactually. These ditches may have served as internal boundary/drainage features, perhaps associated with the orchard that would be mapped in the 19th century.



8. CA PROJECT TEAM

- 8.1 Fieldwork was undertaken by Christina Tapply, assisted by Edoardo Vigo and Parris Stubbings. This report was written by Christina Tapply. The report illustrations were prepared by Esther Escudero. The project was managed for CA by Paul Clarke.

9. REFERENCES

BGS (British Geological Survey) 2018 *Geology of Britain Viewer*
<http://www.bgs.ac.uk/discoveringGeology/geologyOfBritain/viewer.html> Accessed 8
January 2018

CA (Cotswold Archaeology) 2018 *The Orchard, Well Street, Loddiswell, Devon:
Written Scheme of Investigation for an Archaeological Evaluation*

DCLG (Department of Communities and Local Government) 2012 *National Planning
Policy Framework*

Open Domesday 2018 <http://opendomesday.org/place/SX7248/loddiswell/>
Accessed 8 January 2018



APPENDIX A: CONTEXT DESCRIPTIONS

Trench No.	Context No.	Type	Context interpretation	Description	L (m)	W (m)	D (m)	Spot-date
1	100	Layer	Topsoil	Mid greyish brown clayey silt, occasional stone	11.6+	1.3+	0.25	-
1	101	Layer	Subsoil	Light greyish brown clayey silt, occasional sand and stone	11.6+	1.3+	0.35	-
1	102	Layer	Natural substrate	Light orange/yellow clayey silt, frequent sandstone	11.6+	1.3+	-	-
1	103	Cut	Ditch	Straight WNW/ESE linear, gentle sides and concave base	0.6+	1.1	0.3	-
1	104	Fill	Fill of 103	Light orangey brown clayey silt, occasional sandstone	0.6+	1.1	0.3	-
1	105	Cut	Ditch	N/S linear terminus, rounded corners, steep sides and concave base	0.5+	0.58	0.12	Post-medieval
1	106	Fill	Fill of 105	Mid brownish grey clayey silt, friable, occasional subangular stones	0.5+	0.58	0.12	Post-medieval
1	107	Cut	Ditch	N/S linear terminus, rounded corners, steep sides and flat base	0.5+	0.46	0.08	-
1	108	Fill	Fill of 107	Mid reddish brown clayey silt, friable, rare subangular stones	0.5+	0.46	0.08	-
2	200	Layer	Topsoil	Mid greyish brown clayey silt, occasional stone	9+	1.3+	0.22	-
2	201	Layer	Subsoil	Light greyish brown clayey silt, occasional sand and stone	9+	1.3+	0.48	-
2	202	Layer	Natural substrate	Light orange/yellow clayey silt, frequent sandstone	9+	1.3+	-	-
2	203	Cut	Ditch	Straight N/S linear, moderate sides, concave base	0.6+	0.95	0.35	-
2	204	Fill	Fill of 203	Mid orangey brown clayey silt, occasional sandstone	0.6+	0.95	0.35	-
2	205	Cut	Ditch	NW/SE linear, steep concave sides and concave base	0.7+	1	0.3	Post-medieval

Trench No.	Context No.	Type	Context interpretation	Description	L (m)	W (m)	D (m)	Spot-date
2	206	Fill	Fill of 205	Mid greyish brown clayey silt, frequent angular and subangular stones	0.7+	1	0.3	Post-medieval
2	207	Cut	Ditch	NW/SE linear, steep concave sides and flat base	0.7+	1.3	0.8	-
2	208	Fill	Fill of 207	Mid reddish brown clayey silt, friable, rare subangular and angular stones	0.7+	1.3	0.8	-
2	209	Cut	-	Straight NE/SW linear, steep concave sides, flat base	0.7+	0.2	0.18	-
2	210	Fill	Natural substrate?	Mid pinkish brown clayey silt, friable, rare stones	0.7+	0.2	0.18	-
3	300	Layer	Topsoil	Mid greyish brown clayey silt, occasional stone	5+	1.3+	0.3	-
3	301	Layer	Subsoil	Light greyish brown clayey silt, occasional sand and stone	5+	1.3+	0.6	-
3	302	Layer	Natural substrate	Light orange/yellow clayey silt, frequent sandstone	5+	1.3+	-	-

APPENDIX B: OASIS REPORT FORM

PROJECT DETAILS		
Project name	The Orchard, Well Street, Loddiswell, Devon	
Short description	<p>In February 2018, Cotswold Archaeology carried out an archaeological evaluation at tThe Orchard, Well Street, Loddiswell, Devon. A total of three trenches were wereas excavated in the northern part of the site.</p> <p>Due to the site lies on a steep gradient plus overhead cables/buried services, the trench location was slightly altered (see Fig.2) with approval from Steve Reed (Senior Historic Environment Officer, Devon County Council).</p> <p>A total of five shallow ditches linears were excavated and recorded, one linear included one sherd of post-medieval pottery. It is likely that these formed a drainage system. associated with a post-medieval orchard on the site.</p>	
Project dates	6 February 2018	
Project type	Evaluation	
Previous work	N/A	
Future work	Unknown	
PROJECT LOCATION		
Site location	The Orchard, Well Street, Loddiswell, Devon	
Study area (m ² /ha)	0.2ha	
Site co-ordinates	272060 048565	
PROJECT CREATORS		
Name of organisation	Cotswold Archaeology	
Project Brief originator	N/A	
Project Design (WSI) originator	Cotswold Archaeology	
Project Manager	Paul Clarke	
Project Supervisor	Christina Tapply	
MONUMENT TYPE	None	
SIGNIFICANT FINDS	None	
PROJECT ARCHIVES		
	Intended final location of archive	Content
Physical	N/A	N/A
Paper	N/A	N/A
Digital	Archaeology Data Service	Database, digital photos, scanned images of the primary site archive
BIBLIOGRAPHY		
Cotswold Archaeology 2018 <i>The Orchard, Well Street, Loddiswell, Devon: Archaeological Evaluation</i> CA typescript report 18081		

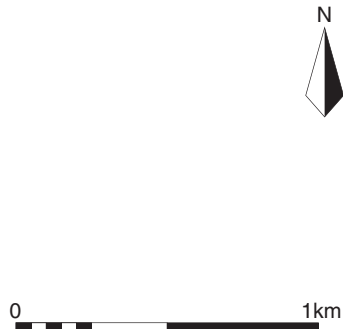
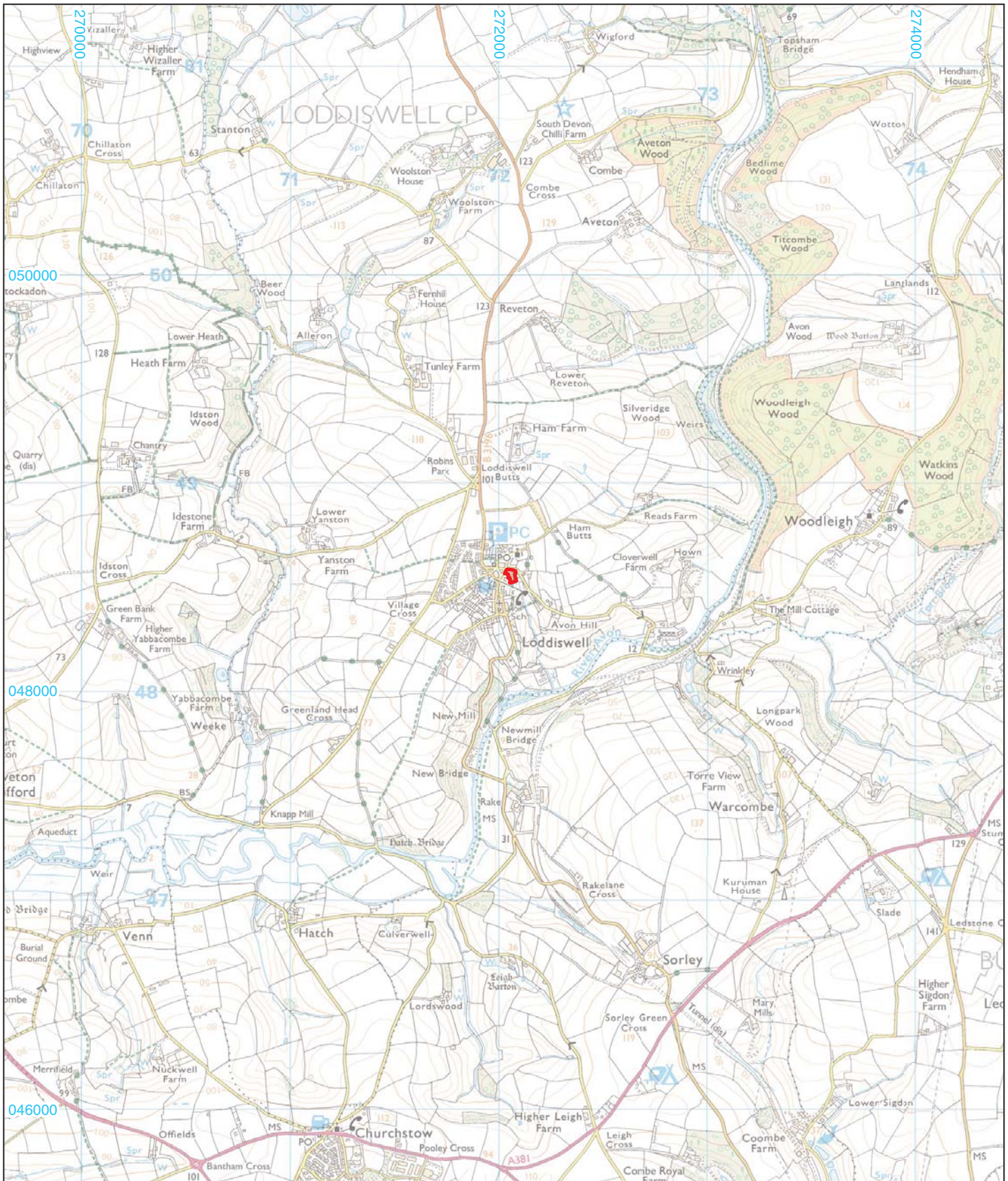

**Cotswold
Archaeology**

Andover 01264 347630
 Cirencester 01285 771022
 Exeter 01392 826185
 Milton Keynes 01908 564660
 www.cotswoldarchaeology.co.uk
 enquiries@cotswoldarchaeology.co.uk





PROJECT TITLE
 The Orchard, Well Street,
 Loddiswell, Devon

FIGURE TITLE
 Site location plan

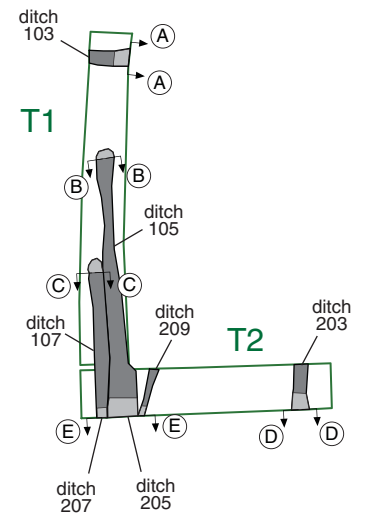
© Crown copyright and database rights 2018
 Ordnance Survey 0100031673

DRAWN BY	EE	PROJECT NO.	880281	FIGURE NO.
CHECKED BY	DJB	DATE	21/02/2018	
APPROVED BY	PC	SCALE@A4	1:25,000	1



-  Site boundary
-  Evaluation trench
-  Archaeological feature (excavated/unexcavated)
-  Section location
-  Service buffer zone



© Crown copyright and database rights 2018 Ordnance Survey 0100031673



Cotswold Archaeology
 Andover 01264 347630
 Cirencester 01285 771022
 Exeter 01392 826185
 Milton Keynes 01908 564660
 www.cotswoldarchaeology.co.uk
 enquiries@cotswoldarchaeology.co.uk

PROJECT TITLE
**The Orchard, Well Street,
 Loddiswell, Devon**

FIGURE TITLE
Trench location plan

DRAWN BY	EE	PROJECT NO.	880281	FIGURE NO.
CHECKED BY	DJB	DATE	22/02/2018	2
APPROVED BY	PC	SCALE@A3	1:250	

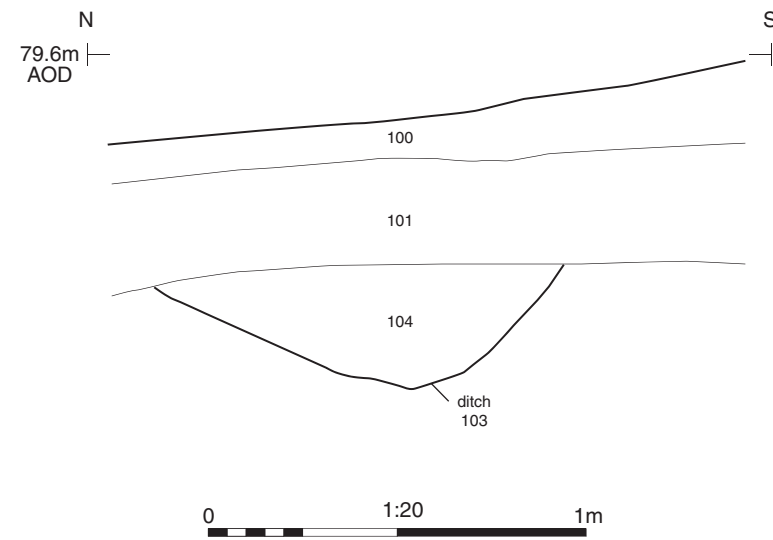
Section AA



Section BB

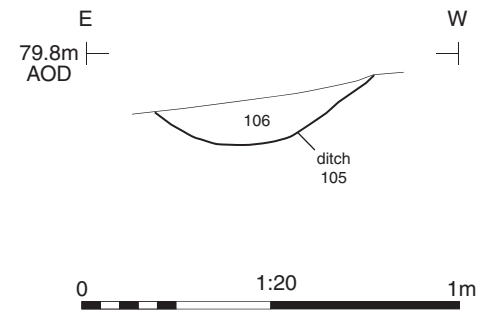

Section CC

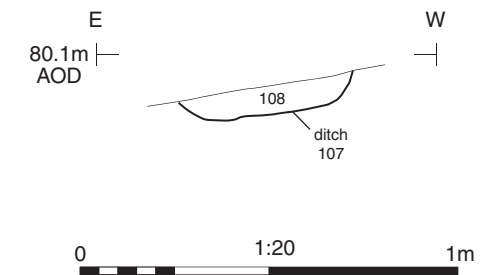

Ditch 103, looking east (1m scale)



Ditch 105, looking south (0.3m scale)



Ditch 107, looking south (0.3m scale)

Cotswold Archaeology
 Andover 01264 347630
 Cirencester 01285 771022
 Exeter 01392 826185
 Milton Keynes 01908 564660
 www.cotswoldarchaeology.co.uk
 enquiries@cotswoldarchaeology.co.uk

PROJECT TITLE
**The Orchard, Well Street,
 Loddiswell, Devon**
 FIGURE TITLE
Trench 1, sections and photographs

DRAWN BY	EE	PROJECT NO.	880281	FIGURE NO.
CHECKED BY	DJB	DATE	22/02/2018	3
APPROVED BY	PC	SCALE@A3	1:20	

Section DD

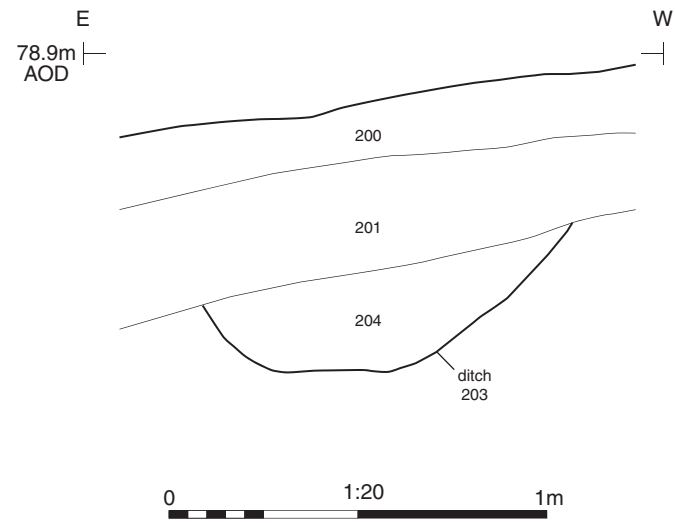

Section EE

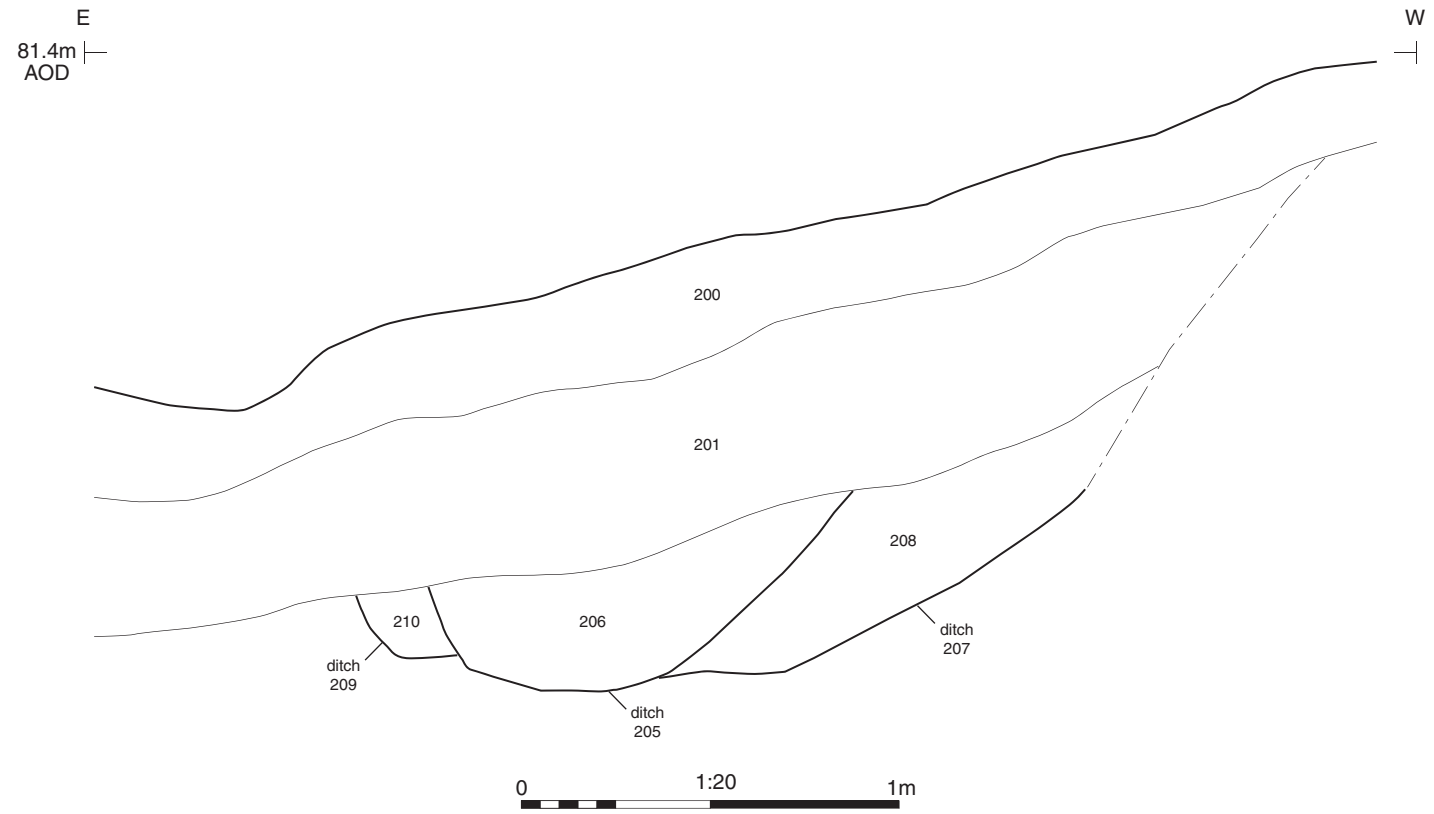

Ditch 203, looking south (1m scale)



Ditches 205, 207 and 209, looking south (1m scale)

Cotswold Archaeology
 Andover 01264 347630
 Cirencester 01285 771022
 Exeter 01392 826185
 Milton Keynes 01908 564660
 www.cotswoldarchaeology.co.uk
 enquiries@cotswoldarchaeology.co.uk

PROJECT TITLE
 The Orchard, Well Street,
 Loddiswell, Devon

FIGURE TITLE
Trench 2, sections and photographs

DRAWN BY	EE	PROJECT NO.	880281	FIGURE NO.
CHECKED BY	DJB	DATE	22/02/2018	
APPROVED BY	PC	SCALE@A3	1:20	4



Trench 3, looking north-east (1m scales)



Representative section of Trench 3, looking south-east (1m scale)



Andover 01264 347630
 Cirencester 01285 771022
 Exeter 01392 826185
 Milton Keynes 01908 564660
 www.cotswoldarchaeology.co.uk
 enquiries@cotswoldarchaeology.co.uk

PROJECT TITLE

The Orchard, Well Street,
 Loddiswell, Devon

FIGURE TITLE

Trench 3, photographs

DRAWN BY EE PROJECT NO. 880281
 CHECKED BY DJB DATE 22/02/2018
 APPROVED BY PC SCALE@A4 NA

FIGURE NO.

5

Andover Office

Stanley House
Walworth Road
Andover
Hampshire
SP10 5LH

t: 01264 347630

Cirencester Office

Building 11
Kemble Enterprise Park
Cirencester
Gloucestershire
GL7 6BQ

t: 01285 771022

Exeter Office

Unit 53
Basepoint Business Centre
Yeoford Way
Marsh Barton Trading Estate
Exeter
EX2 8LB

t: 01392 826185

Milton Keynes Office

Unit 8 - The IO Centre
Fingle Drive
Stonebridge
Milton Keynes
Buckinghamshire
MK13 0AT

t: 01908 564660

e: enquiries@cotswoldarchaeology.co.uk

