

# DIRFT III Ridge and Furrow Survey Northamptonshire

*Geoarchaeological and Archaeological Investigation*



for  
Prologis UK Ltd

CA Project: 660638  
CA Report: 16183

Site Code: DRF16

February 2017



# DIRFT III

## Ridge and Furrow Survey Northamptonshire

### Geoarchaeological and Archaeological Investigation

CA Project: 660638  
CA Report: 16183



Document Control Grid						
Version	Date	Author	Checked by	Status	Reasons for revision	Approved by
Draft	17/1/17	PB	SCC	Draft	Internal review	SCC
Draft 2	10/2/17		SCC	Draft	Client review	SCC
Final	21-2-17			Final	Client review	SCC

*This report is confidential to the client. Cotswold Archaeology accepts no responsibility or liability to any third party to whom this report, or any part of it, is made known. Any such party relies upon this report entirely at their own risk. No part of this report may be reproduced by any means without permission.*

## CONTENTS

SUMMARY .....	4
1. INTRODUCTION.....	5
2. SITE BACKGROUND.....	6
<i>Site location, topography and geology</i> .....	6
<i>Archaeological and historical background</i> .....	7
3. AIMS AND OBJECTIVES.....	8
4. METHODOLOGY .....	9
5. INVESTIGATION RESULTS .....	11
<i>Field 1</i> .....	12
<i>Field 2</i> .....	13
<i>Field 3</i> .....	13
<i>Field 4</i> .....	14
<i>Field 5</i> .....	16
<i>Field 6</i> .....	17
<i>Field 7</i> .....	17
<i>Field 8</i> .....	19
<i>Field 9</i> .....	20
<i>Field 10</i> .....	20
<i>Field 11</i> .....	21
<i>Field 12</i> .....	23
<i>Field 13</i> .....	24
6. THE FINDS .....	25
<i>Pottery</i> .....	25
<i>Lithics</i> .....	25
<i>Ceramic Building Material (CBM)</i> .....	25
<i>Other finds</i> .....	25
7. THE BIOLOGICAL EVIDENCE .....	26
<i>Animal bone</i> .....	26
<i>Palaeoenvironmental evidence</i> .....	26
<i>Pollen analysis</i> .....	26
8. GEOARCHAEOLOGICAL ASSESSMENT .....	27

9.	DISCUSSION.....	28
10.	CA PROJECT TEAM.....	31
11.	REFERENCES.....	32
	APPENDIX A: CONTEXT DESCRIPTIONS .....	34
	APPENDIX B: THE FINDS.....	39
	APPENDIX C: THE PALAEOENVIRONMENTAL EVIDENCE.....	40
	APPENDIX D: GEOARCHAEOLOGICAL REPORT (ARCA 2016).....	41
	APPENDIX E: PROJECT RESEARCH AGENDA .....	42
	APPENDIX F: OASIS REPORT FORM.....	50

## LIST OF ILLUSTRATIONS

Fig. 1	Site location plan, 1:25,000
Fig. 2	Trench location plan, showing archaeological features and LiDAR survey, 1:8000
Fig. 3	Detailed trench location plan (north), showing archaeological features, 1:2500
Fig. 4	Detailed trench location plan (centre), showing archaeological features, 1:2500
Fig. 5	Detailed trench location plan (south), showing archaeological features, 1:2500
Fig. 6	General view of the site from Shenley Farm, looking north-west
Fig. 7	Trench 4, looking north
Fig. 8	Trench 6, looking north-west
Fig. 9	Trench 7, looking south
Fig. 10	Trench 12a, looking south
Fig. 11	Test Pit 2: plan, section and photograph
Fig. 12	Trench 11: plan, sections and photograph
Fig. 13	Trench 14: plan, sections and photographs
Fig. 14	Trench 34: plan, sections and photographs
Fig. 15	Test Pit 3: plan, section and photograph
Fig. 16	Trench 35: plan, sections and photographs
Fig. 17	Trench 8: plan, section and photograph
Fig. 18	Test Pit 1: plan, section and photograph
Fig. 19	Trench 10: plan, section and photographs
Fig. 20	Trench 36: plan, section and photograph
Fig. 21	Trench 17a: plan, sections and photographs
Fig. 22	Trench 17b: plan, section and photograph
Fig. 23	Trench 15: plan, sections and photograph
Fig. 24	Test Pit 4: plan, section and photograph

Fig. 25 Trench 24: plan, section and photograph

Fig. 26 Trench 25, looking south-west

Fig. 27 Trench 30: plan, section and photograph

Fig. 28 Trench 31: plan, section and photographs

Fig. 29 Trench 32: plan and photograph

Fig. 30 Test Pit 5: plan, section and photograph

Fig. 31 Trench 33, looking north-east

Fig. 32 Trench 22: plan, section and photograph

## SUMMARY

<b>Project Location:</b>	DIRFT III, Crick, Northamptonshire
<b>NGR:</b>	SP 5648 7540
<b>Type:</b>	Evaluation
<b>Date:</b>	14th March – 6th April 2016
<b>Location of Archive:</b>	Northamptonshire Archaeological Resource Centre (NARC)
<b>Site Code:</b>	DRF16

During March and April 2016, Cotswold Archaeology carried out a geoarchaeological investigation of the medieval/early post-medieval ridge and furrow earthworks and later field boundaries at the site of Daventry International Rail Freight Terminal (DIRFT III), Northamptonshire. The investigation was commissioned by Prologis UK Ltd as part of a wider programme of heritage mitigation, as required by Requirement 15 of the Development Consent Order issued by the Secretary of State.

Five hand-dug test pits and twenty-one machine-excavated trenches of varying dimensions were excavated across the northern half of the site. The trenches were targeted on remnant ridge and furrow and other earthwork features shown on a LiDAR survey of the site, with the aim of investigating the development of the medieval agricultural landscape from its inception to its eventual conversion to pasture in the later medieval and post-medieval periods.

On the floodplain, a buried soil horizon was encountered beneath the mineralised medieval ploughsoil. This deposit had some of the characteristics of a Boreal soil (i.e. Mesolithic/Neolithic), but pollen analysis suggests that it was probably a cultivated soil. The soil horizon overlay a variety of vegetation features (tree throw hollows etc.), suggesting that the floodplain supported some degree of tree cover prior to clearance for agricultural use. There was no suitable organic material for radiocarbon dating, so the age of the buried soil is uncertain. However, small ditches were also identified beneath the buried soil, probably forming part of an agricultural ditch system of Late Iron Age or Roman date. It is therefore probable that the buried soil horizon dates to the first millennium AD. Investigation of the medieval ridge and furrow earthworks identified some changes to its organisation during its period of active use, but dating these changes was constrained by the lack of dateable artefactual material and the homogeneity of the subsoil that formed the earthwork features.

## 1. INTRODUCTION

- 1.1 During March and April 2016, Cotswold Archaeology (CA) carried out a geoarchaeological investigation of the medieval/early post-medieval ridge and furrow earthworks and later field boundaries at the site of Daventry International Rail Freight Terminal (DIRFT III), Northamptonshire (site centred on NGR SP 5648 7540; Fig. 1). The investigation was commissioned by Prologis UK Ltd as part of a wider programme of heritage mitigation, as required by Requirement 15 of the Development Consent Order issued by the Secretary of State (DCO Ref. TWA 8/1/7).
- 1.2 During pre-application consultation with Historic England and Lesley-Ann Mather, Northamptonshire County Council's Archaeological Advisor (NCCAA), it was agreed that in order to mitigate the loss of ridge & furrow at DIRFT III, a comprehensive earthwork survey, documentary research and field investigation would be undertaken to ensure that this resource was fully recorded prior to the construction phase. In addition, it was agreed that the resultant research would then be disseminated in order to satisfactorily address the archaeological interest of the site.
- 1.3 The project was designed by CgMs Consulting in consultation with other heritage and archaeological specialists, including Professor Stephen Rippon of Exeter University, historian Anthony Breen and Lesley-Ann Mather, NCCAA. Specialist geoarchaeological advice and services were provided to CA by Nick Watson, ARCA (Department of Archaeology, University of Winchester) during the course of the project. Specialist sample analyses (micromorphology and pollen) were undertaken by Quest (Quaternary Scientific, University of Reading). The investigation comprised the hand-excavation of five test pits and twenty-one machine-excavated trenches of varying sizes to target a variety of earthwork features shown on a LiDAR survey of the site (CA 2015).
- 1.4 This report details the results of archaeological and geoarchaeological investigations on the ridge and furrow earthworks undertaken on the site during 2016, in accordance with the Stage 1 *Written Scheme of Investigation (WSI)* which was submitted and approved in 2015 as detailed below:

- The Discharge of Requirement 15 (ref. DCO/2015/0004) relating to the *Written Scheme of Investigation* for the Stage 1 Ridge and Furrow Survey, submitted on the 24th June 2015. This element of Requirement 15 was formally discharged by the LPA on the 16th July 2015;
- The Stage 1 WSI was supplemented by the Stage 2 WSI which detailed the methodologies for undertaking the investigations. The Stage 2 WSI was submitted and approved during January 2016, in advance of the investigations commencing on site.

1.5 This report will be reviewed and the results incorporated into a synthesis report, which will also consider previous stages of work, including the desk-based assessment prepared by CA (2015) and the DIRFT III excavations (CA 2017). The synthesis report will assess the significance of the investigation results, with reference to the original research objectives (CA 2016) and *East Midlands Archaeological Research Framework* (Foard 2006a; 2006b), and offer a critique of the investigation.

1.6 The project was carried out in accordance with the approved WSI (CA 2016) and abided by the Chartered Institute for Archaeologists' (CIfA) *Standard and Guidance for Archaeological Field Evaluation* (CIfA 2014) and the Historic England (formerly English Heritage) procedural documents *Management of Archaeological Projects 2* (EH 1991) and *Management of Research Projects in the Historic Environment (MoRPHE): Project Manager's Guide* (HE 2015).

## 2. SITE BACKGROUND

### *Site location, topography and geology*

2.1 The DIRFT III development area comprises c. 340ha of farmland to the east of Watling Street (A5), between Junctions 18 and 19 of the M1 Motorway (Fig. 1). The land was formerly part of Rugby Radio Station, which covered c. 700ha and comprised an array of antennas centred on 'B' Building. It is bounded by Hillmorton Lane to the north, the M1 Motorway to the east, DIRFT I and II to the south and Watling Street to the west. The now derelict buildings of Shenley Farm lie near the centre of the site, its yard and outbuildings backing on to the M1 motorway. The south-eastern and central-eastern parts of the site lie on an undulating slope on the



western edge of a ridge between Crick and Kilsby, with a maximum elevation of c.120m above Ordnance Datum (aOD). From here, the ridge slopes down towards the A5 and Clifton Brook at c. 90m aOD (Fig. 6). Beyond the northern site boundary the land rises gradually towards a ridge extending between Clifton Upon Dunsmore and Lilbourne.

- 2.2 According to the British Geological Survey (BGS), the bedrock geology beneath the site comprises Jurassic sedimentary mudstone of the Charmouth Mudstone Formation (BGS 2016). Across much of the site, particularly to the north and west, alluvial deposits of Pleistocene age are shown overlying the bedrock and filling the basin of the Clifton Brook, whilst at the north-eastern site margin and in the central area, Pleistocene river terrace deposits are indicated. No superficial deposits are shown by the BGS overlying the bedrock in approximately the south-eastern third of the site.

### ***Archaeological and historical background***

- 2.3 The historical and archaeological background of the site has been presented in detail in the *Heritage Assessment* prepared by CgMs (2012), which was included in the *Environmental Statement* for the DIRFT III development. In summary, the site was identified as being of archaeological importance, largely on account of the well-preserved ridge and furrow earthworks that survive in areas within its boundary. These earthworks, the remains of the medieval open fields that surrounded the villages of Lilbourne, Crick and Yelvertoft, are the subject of the current project.
- 2.4 A geophysical survey undertaken by Northamptonshire Archaeology (NA 2009) and subsequent trial trenching by Oxford Archaeology (OA 2011) has demonstrated the presence of other sub-surface features within the site. Recently completed strip and map excavation of the site by CA (forthcoming) has confirmed that these are the remains of Iron Age and Roman field systems, similar to those investigated by CA to the west of the site (CA 2012). A prehistoric pit alignment has also been identified, running along the edge of the flood plain at the southern end of the site. Also considered to be of heritage interest are Shenley Farm and Rugby Radio Station 'B' Station and its associated aerial system, which have been the subject of building recording surveys (CA 2014; MOLA 2015a; MOLA 2015b).
- 2.5 In the wider area, the development of DIRFT, which started in the early to mid-1990s, has led to extensive archaeological investigation in the area to the south and

south-west that has revealed a rich and densely settled prehistoric landscape, largely dating to the Iron Age. The major sites are Long Dole, excavated by Northamptonshire Archaeology in 1994 (Chapman 1994), Covert Farm, excavated by the Birmingham University Field Archaeology Unit in 1997-8 (BUFAU 1998) and two sites at DIRFT II, Kilsby, excavated in 2006 and 2010 by CA (2011). Long Dole, an enclosed settlement of 30-35 roundhouses, lies immediately to the south of the site. The results of these investigations have recently been published (Hughes and Woodward 2016; Masefield *et al.* 2016).

- 2.6 Rugby Radio Station was built in the mid 1920s and originally comprised an array of aerials around the neo-Classical brick building to the west of Watling Street, later known as 'C' Building. Following WWII, to cope with an increase in demand, 700ha of farmland to the east of Watling Street was purchased and a new radio station and antenna array was constructed. 'B' Building was officially opened in 1955 and contained twenty-eight transmitters; combined with the existing twenty-nine transmitters to the west of the A5, this made Rugby the largest radio transmitting station in the world. With the increasingly rapid move towards satellite communications and the rise of digital technology over the past thirty years, the role of the former radio station diminished and the last radio transmission from Rugby was made on 4th July 2007.

### 3. AIMS AND OBJECTIVES

- 3.1 The general aim of the project was to conduct a field investigation and assessment to fulfil the relevant recommendations set out in *Ridge and Furrow Assessment (Stage 1), DIRFT III, Northamptonshire* (CgMs 2015). The specific recommendations refer to the research objectives detailed in *East Midlands Archaeological Research Framework: An Archaeological Resource Assessment of Anglo-Saxon Northamptonshire (400-1066)* (Foard 2006a) and *East Midlands Archaeological Research Framework: An Archaeological Resource Assessment of Medieval Northamptonshire* (Foard 2006b).
- 3.2 The general aim of the investigation was to contribute to an understanding of seven of the research priorities stated in the Stage 1 assessment report (Research Agenda nos. 1, 5, 7, 8, 10, 11 and 15; CA 2015); the recommendations are presented in full in Appendix C and the trenches/test pits associated with each research agenda item are shown in the table below.

Research Agenda no.	Trench nos.
1	3–17c, 22–25, 30, 32, 33
5	3, 5, 7, 9, 12a, 12b, 13, 16
7	Test pits
8	3–17c, 22–25, 30, 32, 33
10	3–17c, 22–25, 30, 32, 33
11	3–17c, 22–25, 30, 32, 33
15	3–17c, 22–25, 30, 32, 33

3.3 Key research documents relating to the historic ridge and furrow of the Midlands referred to in the preparation of the report included *Turning the Plough* (Northamptonshire County Council 2001), *Turning the Plough Update Assessment 2012* (Gloucestershire County Council 2012), *The Open Fields of England* (Hall 2014), *An Atlas of Northamptonshire: The Medieval and Early Modern Landscape* (Partida *et al.* 2013) and David Hall's previous assessment content held by the local records office.

#### 4. METHODOLOGY

4.1 The investigation comprised the hand-excavation of five 3m x 2m test pits and the machine-excavation of twenty-one trial trenches of varying dimensions (Fig. 2). The trenching scheme varied from that presented in the WSI (CA 2015) due to a variety of site constraints, including extensive flooding of the western part of the site; the dimensions and numbers of the trenches that could and could not be excavated are presented in Table 1 below.

4.2 Trenches 3 and 5 could not be excavated as they lay within an ecological protection zone. Flooding prevented the excavation of Trench 12b, although three new trenches (34-36) that were not included in the original trench plan were excavated in its stead. Ongoing construction works prevented the excavation of Trenches 9 and 13 and the intended site of Trench 17c lay beneath a large soil storage bund. Trench 23 was not excavated as it lay across a thick hedgerow and an area of modern disturbance.

Table 1: Summary of the trenching scheme as presented in the WSI and as actually carried out

Trench size	No.	Actual no.	Trench/TP nos. (excavated trenches in bold)
3m x 2m	5	5	<b>TP 1 - 5</b>
10m x 4m	20	13	<b>3, 4, 5, 6-8, 9, 10, 11, 12a, 16, 17b, 17c, 22, 23, 24, 25, 30, 32, 33</b>
20m x 4m	1	1	<b>14</b>
20m x 2m	1	3	13, <b>34, 35, 36</b> (Trenches 34–36 were additional to the original scheme)
40m x 2m	0	1	<b>10</b>
50m x 2m	1	1	<b>31</b>
60m x 2m	1	1	<b>17a</b> (in two parts, 20m and 40m)
20m x 20m	2	1	12b, <b>15</b>

- 4.3 The first stage of the fieldwork comprised the excavation of the hand-dug test pits, which were excavated through the topsoil and subsoil deposits to recover any pottery sherds that may have been present and to investigate any buried soils that may have been encountered below the subsoil (relict land surface). The location of the test pits was determined following consultation with ARCA. In accordance with instruction received from HE, the pits were aligned lengthwise at the centre of selected ridges and measured 3m long by 2m wide. The topsoil and subsoil was removed in 10cm spits using a mattock. Where relict land surfaces were identified beneath the subsoil, the interface was cleaned by trowel to identify any plough or spade marks. Pottery recovered from hand dug deposits was collected and separated by spit.
- 4.4 The trial trenches were located over selected earthworks and field boundaries shown on LiDAR images of the site in order to investigate their morphology and the nature and extent of any earlier features and/or buried soils. Trenches were set out on OS National Grid (NGR) co-ordinates using Leica GPS and scanned for live services by trained CA staff using CAT and Genny equipment in accordance with the CA *Safe System of Work for Avoiding Underground Services*. The final ‘as dug’ trench plan was recorded with GPS.

- 4.5 Each context was recorded on a *pro forma* context sheet by written and measured description. Principal deposits were recorded electronically using Leica GPS. Sections were drawn at 1:10 or 1:20 scale, as appropriate. Where detailed feature planning was undertaken using GPS, this was carried out in accordance with *Technical Manual 4: Survey Manual* (CA 2009). A photographic record was maintained using high resolution digital images. All artefacts encountered were recovered and retained for processing and analysis, in accordance with *Technical Manual 3: Treatment of Finds Immediately after Excavation* (CA 2010).
- 4.6 In consultation with Historic England and ARCA, deposits were assessed for their palaeoenvironmental potential in accordance with *Technical Manual 2: The Taking and Processing of Environmental and Other Samples from Archaeological Sites*. Two bulk soil samples and two monolith samples were taken from selected deposits.
- 4.7 Upon completion of the fieldwork and with the approval of NCCAA, all trenches were simply backfilled and made level as far as practicable through the tracking of the excavator.
- 4.8 The archive and artefacts from the investigation are currently held by CA at their offices in Milton Keynes. Subject to the agreement of the legal landowner the artefacts will be deposited at the Northamptonshire Archaeological Resource Centre (NARC), along with the site archive. A summary of information from this project, as set out in Appendix F, will be entered onto the OASIS online database of archaeological projects in Britain.

## 5. INVESTIGATION RESULTS

- 5.1 Selected ridge and furrow earthworks and field boundaries were investigated in thirteen fields in the northern half of the site (Figs 2–5). All of the trenches were located to the north of the access track to Shenley Farm, with the exception of Trench 22 that was located in a narrow strip of land immediately to the south of the farm buildings and adjacent to the M1 motorway. The fieldwork comprised the hand-excavation of five 3m x 2m test pits and the machine-excavation of twenty-one trial trenches of varying dimensions (see Table 1).

5.2 The identifying numbers of the trenches and test pits in each field are shown in Table 2 below. Ditches of probable Roman or prehistoric date were encountered in Trenches 11, 14, 15, 31, 34 and Test Pits 1 and 4; the ditch identified in Trench 22 dates to the post-medieval/modern period, when the open field system was enclosed. A buried soil horizon predating the inception of the medieval open field system was identified in Trenches 14, 17a, 34–36 and Test Pits 1–3. Other than the ridge and furrow earthworks or naturally formed vegetation features, no archaeological remains were encountered in Trenches 4, 6–8, 10, 12, 17b, 24, 25, 30, 32, 33, 35, 36 or Test Pit 5. There were few artefacts in the excavated deposits and those that were recovered are mentioned in the text below and in Section 6. Detailed summaries of the recorded contexts, finds and biological evidence are to be found in Appendices A, B and C respectively. In the text, the bold numbers in parentheses after the field numbers (e.g. **34**) refer to the earthwork block numbers given in the Stage 1 ridge and furrow assessment (CA 2015, fig. 6.7).

*Table 2: Trench and test pit numbers by field*

Field no.	Trench/test pit no.	Field no.	Trench/test pit no.
1	Trench 4	8	Trench 17a
2	Trench 6	9	Trench 17b
3	Trenches 7 and 12a	10	Trench 15
4	Trenches 11, 14, 34 and TP2	11	Trenches 24, 25, 30–32 and TP4
5	Trench 35 and TP3	12	Trench 33 and TP5
6	Trench 8	13	Trench 22
7	Trenches 10, 36 and TP1	-	

### **Field 1**

5.3 Field 1 (**42**) was located to the north of Clifton Brook and c. 1.3km north-west of Shenley Farm (Figs 2 and 3). Within the field, faint traces of ridge and furrow ploughing on an approximate north to south alignment are shown on the LiDAR survey and were evident on the ground. One trench (Trench 4) was excavated in the field to investigate a former headland on an approximate east to west alignment.

### **Trench 4**

5.4 The geological substrate was firm, mid greyish brown clay (4002), which was encountered at a depth of c. 0.40m bgl (Fig. 7). It was overlain in sequence by a

0.12m thick layer of firm, light orangey grey clayey silt subsoil (4001) and a 0.30m thick layer of topsoil/turf (4000).

### **Field 2**

- 5.5 Field 2 (41), which was located c. 1.2km north-north-west of Shenley Farm, was the western remnant of a larger field that had been divided in two by the construction of the M1 motorway (Figs 2 and 3). The LiDAR survey shows faint earthworks of ridge and furrow ploughing on an approximate north to south alignment within the field; Trench 6 was excavated to investigate a former post-medieval/modern field boundary.

### **Trench 6**

- 5.6 The geological substrate, which was encountered at a depth of c. 0.45m bgl (Fig. 8), was firm, mid brownish orange clay (601). There was no subsoil and the geological substrate was directly overlain by up to 0.47m of topsoil/turf. A modern field drain and service trench (602) passed through the trench on a north-north-east to south-south-west alignment.

### **Field 3**

- 5.7 Field 3 (34, 35) was located in the north-western part of the site (Figs 2 and 3), c. 350m to the north-west of the former Rugby Radio Station 'B' Building and 200m east of Watling Street (A5). Well-preserved ridge and furrow earthworks on an approximate north to south alignment were visible in the field and are clearly shown on the LiDAR survey. Two trenches were excavated to investigate a former medieval boundary (Trench 12a) and a post-medieval/modern boundary/drainage feature (Trenches 7).

### **Trench 7**

- 5.8 The geological substrate was firm, mid brownish orange silty clay (702), which was encountered at a depth of between 0.44m and 0.50m bgl (Fig. 9). It was overlain by 0.25m of firm, mid greyish brown silty clay subsoil (701), succeeded by a 0.25m thick layer of topsoil/turf (700).

### **Trench 12a**

- 5.9 The geological substrate was encountered at a depth of 0.54m bgl (Fig. 10) and comprised firm, light brownish yellow silty sand (1202). It was overlain by firm, mid

brownish grey clayey silt subsoil (1201) with a thickness of 0.27m, which was sealed by a 0.30m thick layer of topsoil/turf (1200).

#### **Field 4**

- 5.10 Field 4 (37) was located c. 1km north-west of Shenley Farm and c. 300m east of Watling Street (Figs 2 and 3). The well-preserved earthworks of ridge and furrow ploughing on an approximate north to south alignment are shown on the LiDAR survey and were clearly visible on the ground (Fig. 8). Three trenches and a test pit were excavated within the field: Trenches 11, 34 and Test Pit 2 were located along ridges; Trench 14 investigated the boundary ditch and headland on the southern side of the field.

#### **Test Pit 2**

- 5.11 Test Pit 2 was relocated to the east of its intended location due to flooding in the western half of the field. The geological substrate, which was encountered at a depth of c. 0.6m bgl (Fig. 11), was firm, light yellowish brown sandy clay (208). In the south-west corner of the test pit there was an irregular, shallow hollow (206), probably formed by tree root disturbance, which was up to 0.11m deep. It was filled with friable, dark brownish grey silty clay (207), from which was recovered a piece of flint that had possibly been deliberately struck. A similar feature (204) with a similar depth was identified in the south-east corner of the test pit.
- 5.12 The probable tree bowls were overlain by a 0.19m thick deposit of friable, dark greyish brown sandy clay (203), interpreted as a buried soil horizon. This in turn was overlain by a 0.22m thick deposit of friable, mid greyish brown silty clay subsoil. This was excavated in two spits (202 lower, 201 upper), the lower of which contained two abraded sherds of Roman and medieval pottery and small pieces of lead sheet. The subsoil was sealed by a 0.2m thick layer of topsoil/turf (200).

#### **Trench 11**

- 5.13 The geological substrate was encountered at a depth of c. 0.46m bgl (Fig. 12) and comprised firm, light orangey brown sandy clay (1102). Towards the centre of the trench the substrate was cut by two shallow, irregular features (1105 and 1107) and a similar but larger feature (1103) was recorded to the north-east. These features, which were between 0.12m and 0.24m deep and were probably formed by tree throw, were sealed by firm, mid greyish brown silty clay subsoil (1101), which was up to 0.27m thick. The overlying topsoil/turf (1100) was approximately 0.22m thick.



- 5.14 Towards the southern end of the trench the ridge was cut by ditch 1109, which was aligned west-north-west to east-south-east, measured 0.94m wide by 0.34m deep and had steeply sloping, slightly concave sides and a flat base. It corresponds with a ditch shown cutting the ridges in the surface of the field on the LiDAR survey.

#### **Trench 14**

- 5.15 To avoid damage to a field boundary fence, the trench was excavated in two parts, with the southern part lying within Field 8. The geological substrate was encountered between 0.20m and 0.48m bgl (Fig. 13) and comprised firm, mid yellowish brown clay (1404). South of the boundary this was overlain by a deposit, up to 0.2m thick, of firm, mid greyish brown silty clay (1403) that was interpreted as a buried soil horizon.
- 5.16 The possible buried soil horizon was cut by a north-west to south-east aligned ditch (1405) that measured 0.7m wide by 0.3m deep and had steeply sloping, straight sides and a concave base (Fig. 22, Sections MM and NN). Its fill comprised soft, mid greyish brown, silty clay (1406); a soil sample was taken from this deposit but it was found to be sterile, apart from three unidentifiable pieces of charcoal. The ditch appeared to be associated with pre-ridge and furrow land division and was on a markedly different alignment to the medieval earthworks. The ditch and relict land surface were sealed by a deposit of soft, light reddish brown silt subsoil (1402), up to 0.4m thick, which formed the body of the headland to the north and south of the boundary ditch.
- 5.17 The subsoil was overlain by up to 0.2m of soft, mid reddish brown silt (1401) that formed the upper layer of the bank south of the boundary ditch; this deposit may have been upcast from an earlier cut of that ditch. The upper bank material was truncated by the most recent cut of the boundary ditch (1407), which also cut through ditch 1405. The sequence was sealed by a layer, up to 0.2m thick, of topsoil/turf (1400).

#### **Trench 34**

- 5.18 The geological substrate, which comprised light reddish brown and mid greenish grey clay with patches of friable, dark reddish brown clayey sand (3403), was recorded between 0.42m and 0.61m bgl (Fig. 14). Approximately 3.5m from the southern end of the trench, the substrate was cut by ditch 3404, which was aligned

north-west to south-east, measured 0.76m wide by 0.23m deep and had moderately sloping, slightly concave sides and a flattish base, giving it a somewhat asymmetrical profile. It was filled with soft, dark greyish brown silty clay (3405). The ditch was overlain by soft, mid brownish grey clayey silt (3402), interpreted as a buried soil horizon, that varied in thickness between 0.1m and 0.24m. This was overlain by up to 0.32m of firm, mid orangey brown silty clay subsoil (3401), succeeded by a 0.2m thick layer of topsoil/turf (3400).

### **Field 5**

- 5.19 Located c. 500m to the north-east of the former 'B' Station site and immediately south of Clifton Brook, Field 5 (37) is shown on the LiDAR survey to contain well-preserved earthworks of ridge and furrow (Figs 2 and 3). These are aligned approximately north to south and were investigated by Test Pit 3 and Trench 35.

### **Test Pit 3**

- 5.20 The test pit was relocated to the east of its intended location due to flooding in the western half of the field. The geological substrate (305), which was encountered at a depth of between 0.43m and 0.52m bgl, was firm, mid yellowish orange clay (Fig. 15). This was overlain by a 0.19m thick layer of firm, mid bluish grey silty clay, interpreted as a buried soil and excavated in two spits (304 lower, 303 upper). The buried soil was sealed by a 0.25m thick deposit of light greyish brown silty clay subsoil/ridge material, which was also excavated in two spits (302 lower, 301 upper). The ridge material was sealed by a 0.15m thick layer of topsoil/turf (300).

### **Trench 35**

- 5.21 The geological substrate was encountered between 0.37m and 0.56m bgl (Fig. 16) and comprised friable, light to mid reddish brown clayey sand and soft, mid greenish grey clay (3503). The substrate was overlain intermittently by a deposit of soft, dark brownish grey clayey silt (3502), up to 0.16m thick, which appeared to be a buried soil that survived in patches beneath the eastern and central ridge but not the westernmost feature.
- 5.22 Two north/south aligned furrows, 3504 to the east and 3506 to the west, cut through the substrate, the former 1.9m wide and the latter 1.7m wide. They were filled with friable, dark reddish brown clayey sand (3505/3507), which yielded a fragment of post-medieval or modern tile. The furrows were offset from the base of the furrows at the surface; furrow 3504 lay c. 1.7m to the west of the corresponding surface

depression and furrow 3506 lay c. 1m to the east, such that the centres of the surface features were c. 10.2m apart, whereas the centres of the buried furrows were c. 7.5m apart (Fig. 34, Section AA).

- 5.23 The furrows were overlain by a discontinuous layer of friable to soft, mid to dark reddish brown sandy clay subsoil (3501), up to 0.26m thick. This was the material that constituted the upstanding ridges and had also slumped to partly cover furrow 3504 but not furrow 3506. The surface layer comprised a layer, up to 0.35m thick, of topsoil/turf (3500).

### **Field 6**

- 5.24 Field 6 (40) was located c. 1.0km to the north-north-west of Shenley Farm, immediately to the south of Clifton Brook and adjacent to the M1 motorway (Figs 2 and 3). The LiDAR survey shows ridge and furrow earthworks on an approximate north to south alignment within the field; one of the ridges was investigated by Trench 8.

### **Trench 8**

- 5.25 The geological substrate was a variable, firm, light brownish grey gravel and light greyish yellow clay (802), the surface of which was encountered at a depth of between 0.43m and 0.58m bgl (Fig. 17). It was overlain by a 0.22m thick deposit of firm, light orangey grey silty clay subsoil (801).
- 5.26 In the north-eastern corner of the trench the subsoil was cut by a large, irregular feature (805), probably formed by tree throw, which measured in excess of 1.3m wide by up to 0.22m deep. Its fill comprised firm, dark brownish grey clayey silt (806). The western edge of feature 805 was cut by a north-west to south-east aligned furrow (803), which had a shallow, concave profile, measured 1.3m wide by 0.22m deep and was filled with soft, mid greyish brown, silty clay (804).

### **Field 7**

- 5.27 Field 7 (37), which was located c. 800m north-north-west of Shenley Farm, contained well-preserved ridge and furrow earthworks that extended northwards into Field 6 (Figs 2 and 3). Two trenches and a test pit were excavated in the field: Test Pit 1 and Trench 36 targeted two ridges; Trench 10 investigated the field boundary and headland at the field's southern edge.

### **Test Pit 1**

- 5.28 The geological substrate (105), the surface of which was encountered at between 0.47m and 0.62m below ground level (bgl), was firm, light yellowish orange clay (Fig. 18). Cut into this deposit at the south-east corner of the test pit was ditch 106, which was on an approximate north-east/south-west alignment. It measured 0.83m wide by 0.2m deep, exhibited moderately sloping, mostly straight sides, a flattish base and was filled with firm, mid bluish grey silty clay (107).
- 5.29 The ditch was sealed by a 0.2m thick deposit of firm, dark bluish grey silty clay, a probable buried soil horizon that was excavated in two spits (104 lower, 103 upper). The deposit was overlain by a 0.19m thick layer of soft, mid greyish brown silty clay subsoil, which and was also excavated in two spits (102 lower, 101 upper). The surface deposit comprised a layer, up to 0.25m thick, of topsoil/turf (100).

### **Trench 10**

- 5.30 Trench 10 targeted the junction between a prominent ridge and a headland in Field 7 and extended across the modern field boundary ditch into Field 10, where less well-preserved ridge and furrow earthworks were evident (Figs 2 and 3). The trench was excavated in two sections to prevent flooding from the water-filled boundary ditch.
- 5.31 The geological substrate comprised firm, light yellowish blue clay, the surface of which lay at 0.45m bgl (Fig. 19), overlain by up to 0.26m of firm, dark brownish grey, silty clay (1003). Both of these layers were interpreted as glacial till deposits, the upper having experienced a greater level of oxidation than the lower (Nick Watson pers. comm.). The till was overlain by firm, mid greyish brown clayey silt subsoil (1001) with a thickness of approximately 0.25m, which was in turn overlain by a 0.20m thick layer of topsoil/turf (1000).

### **Trench 36**

- 5.32 The geological substrate comprised soft, light yellowish brown clay (3603), which was recorded at a depth of between 0.44m and 0.66m bgl (Fig. 20). This was overlain along much of the trench by a firm, dark bluish grey clay (3602), interpreted as a weakly developed buried soil, which was up to 0.22m thick. This was sealed by up to 0.3m of soft, light reddish brown silty clay subsoil (3601) and the sequence was completed by a modern topsoil layer (3600), up to 0.2m thick.

### **Field 8**

- 5.33 Field 8 (**28, 29**) was located immediately to the north and north-east of the site of the former Rugby Radio Station 'B' Building, c. 200m to the east of Watling Street (Figs 2 and 4). The LiDAR survey shows ridge and furrow earthworks on an approximate north to south alignment across much of the field, although in the south-west corner there is a block of ridge and furrow on a north-west to south-east alignment, separated from the main block of earthworks by a headland. Trench 17a comprised two parts: the northern part (17a.1) was located across the junction between the headland and a ridge to the north; the lengthier southern part (17a.2) was located across the block of ridge and furrow earthworks in the field's south-west corner.

### **Trench 17a**

- 5.34 The geological substrate in both parts of the trench (1702/1722) was a varied deposit of firm mid brownish grey gravel and mid orangey yellow clay, which was exposed at depths of between 0.33m and 0.65m bgl (Fig. 21). This was overlain by an intermittent layer of firm, mid to dark brownish grey silty clay (1704/1723), probably remnants of a buried soil horizon. It was most extensively preserved at the south-west end of Trench 17a.2, where it was up to 0.2m thick.
- 5.35 In the southern half of Trench 17a.1, the geological substrate was overlain by a layer, up to 0.2m thick, of moderately firm, dark brownish grey clayey silt (1703), probably the remains of a buried ploughsoil beneath the later headland (Fig. 24, Section QQ). This was overlain by up to 0.33m of relatively soft, mid orangey brown clayey silt subsoil (1701). The subsoil was overlain by a layer of topsoil/turf (1700/1720), up to 0.2m thick.
- 5.36 In Trench 17a.2 the substrate was cut by a linear feature (1724) that measured up to 2m wide by 0.3m deep, had gently sloping, concave sides, a concave base and was filled with firm, mid brownish grey clayey silt (1725) (Fig. 24, Section RR). It followed approximately the same north-west to south-east alignment as the ridge and furrow visible in the LiDAR imagery and mirrored a depression seen in the surface in this area that appears to have been the base of a furrow. The probable furrow was sealed by a layer of firm, mid greyish brown silty clay subsoil (1721) that thickened to the north and south and appears to originally been headland/ridge material that sealed the buried soil and had gradually slumped across the furrow. A second furrow was recorded near the centre of the trench.

### **Field 9**

- 5.37 Within Field 9 (27), which was located immediately to the east of the site of the former Rugby Radio Station 'B' Building, faint traces of ridge and furrow earthworks on an approximate north-east to south-west alignment are shown on the LiDAR survey (Figs 2 and 4). Trench 17b investigated one of the ridges near the field's southernmost boundary, which is shown to overlie a possible medieval boundary on the LiDAR survey.

### **Trench 17b**

- 5.38 The geological substrate (1752), exposed at a depth of c. 0.4m bgl, was firm, mid yellowish blue clay with gravel patches (Fig. 22). Cut into the clay was the northern terminal of a probable small ditch (1753), which dog-legged slightly to the west. It measured up to 1.0m wide by 0.26m deep, had moderately sloping sides, a flat base and its fill (1754) comprised soft, light yellowish brown silty clay (Fig. 25, Section SS). The feature had been extensively truncated by a modern land drain. The feature was sealed in sequence by a layer, approximately 0.1m thick, of firm, light greyish brown clay subsoil (1751) and a layer of topsoil/turf (1750), up to 0.32m thick

### **Field 10**

- 5.39 Field 10 (18, 21, 25, 26), which was located c. 460m north-north-west of Shenley Farm, enclosed parts of four blocks of ridge and furrow on varying alignments (Figs 2 and 4). A faint linear feature, possibly the remains of a former headland, is shown on the LiDAR survey extending north-westwards from the corner of one of the blocks of ridge and furrow; Trench 15 was excavated to investigate this feature.

### **Trench 15**

- 5.40 The geological substrate was soft, light to mid reddish brown and mid bluish grey clay (1503), which was exposed at a depth of 0.34m bgl (Fig. 23). This was overlain by a layer of glacial till, which was approximately 0.1m thick and comprised mid greenish brown silty clay (1502). Cut into this deposit near the centre of trench was a short length of shallow ditch (1504/1508) that roughly corresponded with the north-west to south-east aligned feature shown on the LiDAR survey. It was approximately 10m long and had rounded terminals at either end; in cross-section, it measured 0.45m wide by 0.09m deep (Fig. 23, Section OO). Its fill comprised soft, mid greyish and reddish brown silty clay (1505/1509).

- 5.41 A possible circular posthole (1506) was identified next to the ditch's north-western terminal (1508). It had a diameter of 0.35m, a depth of 0.10m and was filled with soft, mid reddish brown silty clay (1507).
- 5.42 The features were overlain by a 0.1m thick layer of soft, dark reddish brown silty clay subsoil (1501), from which was recovered a sherd of medieval pottery, which has been dated to the 13th to 15th century. The subsoil was overlain by topsoil/turf (1500), which was 0.14m thick.

### **Field 11**

- 5.43 Field 11 (17–20) was located c. 100m north-west of Shenley Farm, adjacent to the M1 motorway (Figs 2 and 4). The LiDAR survey shows that it largely encloses a regular block of ridge and furrow earthworks on an approximate north-west to south-east alignment and parts of four other blocks on varying alignments that extend into adjacent fields. Five trenches (Trenches 24, 25, 30–32) and one hand-dug test pit (TP4) were excavated in the field to investigate a range of earthwork features identified by the LiDAR survey.

### **Test Pit 4**

- 5.44 The geological substrate, encountered at a depth of between 0.44m and 0.57m bgl (Fig. 24), was a firm but mixed light greyish orange clay and mid brownish grey gravel (404). In the south-west corner of the test pit was an irregular, shallow tree throw hollow (407), measuring at least 1.3m wide by 0.13m deep. It was filled with a firm, mid reddish brown coarse sandy gravel (408).
- 5.45 At the northern edge of the test pit and extending to the north-east was a possible shallow pit or ditch terminus (405). It measured 0.8m wide by 0.17m deep and had gently sloping, slightly concave sides and a flattish base. It was filled with firm, light greyish brown silty clay (406). This feature was sealed by a deposit, up to 0.32m thick, of firm, light brownish grey silty clay subsoil that was excavated in three spits (403 lower, 402 middle, 401 upper). The subsoil was sealed by a 0.15m thick layer of topsoil/turf (400).

### **Trench 24**

- 5.46 The geological substrate comprised soft, dark bluish grey clay and light reddish brown clayey sand (2402), the surface of which was encountered at a depth of 0.46m bgl (Fig. 25). Passing through the centre of the trench on an approximate

north to south alignment was an irregular feature (2403) that was no more than 0.3m deep; the feature is probably a silted-up animal burrow. It was overlain in sequence by a 0.2m thick deposit of soft, dark reddish brown silty clay subsoil (2401) and up to 0.26m of topsoil/turf (2400).

### **Trench 25**

- 5.47 The geological substrate, which was encountered at a depth of 0.43m bgl (Fig. 26), comprised firm, light orangey brown sandy clay (2502). It was overlain in sequence by 0.26m of firm, mid yellowish brown silty clay subsoil (2501) and a 0.17m thick layer of topsoil/turf. There were no archaeological or topographic features within the trench.

### **Trench 30**

- 5.48 The geological substrate comprised firm, mid brownish orange gravel (3002), which was exposed at a depth of 0.98m bgl (Fig. 27). A large, irregular feature (3005) in the south-eastern part of the trench was shown by excavation to be geological in origin, its firm, mid greyish brown clayey silt fill (3006) containing frequent fossil shells.
- 5.49 The feature was overlain by up to 0.2m of mid greyish brown clayey silt subsoil (3001), which was cut by a furrow (3003) that crossed the centre of the trench on an approximate north-west to south-east alignment, corresponding with the alignment of the earthworks shown on the LiDAR survey (Fig. 27, Section VV). The furrow measured c. 1.3m wide by 0.28m deep, had gently sloping sides, a concave base and was filled with mid brownish grey silty clay (3004). It was overlain by topsoil/turf (3000), which was c. 0.22m thick.

### **Trench 31**

- 5.50 Trench 31 was located near the northern corner of the field to investigate the boundary between two blocks of furrows on varying alignments. The geological substrate (3102) was firm, light brownish grey silty clay (Fig. 28). Near the centre of the trench, immediately north of a possible boundary feature that was manifest on the surface as a long, linear bank, was ditch 3103. It measured 2.0m wide by 0.54m deep (Fig. 28, Section WW), had moderately sloping, slightly concave sides, a flattish base and was filled with firm, light brownish grey silty clay (3104), from which a small quantity of animal bone was retrieved.



- 5.51 The ditch was overlain by firm, light brownish grey, silty clay subsoil (3101), which varied in thickness in relation to the area's surface topography. The subsoil was overlain by topsoil/turf (3100), which was up to 0.25m thick.

### **Trench 32**

- 5.52 Trench 32 was located in the northern corner of the field to investigate the same features targeted by Trench 31. The geological substrate, which was encountered at 0.54m bgl (Fig. 32), was soft, dark bluish grey clay with dark, reddish brown lenses (3202). In the south-western part of the trench there was an irregular feature (3203), probably of natural origin, which measured more than 4.3m long by 2.8m wide and was filled with a soft, mid reddish brown clay. The substrate was overlain by dark reddish brown silty clay subsoil (3201), up to 0.36m thick, which was sealed by a 0.18m thick layer of topsoil/turf (3200).

### **Field 12**

- 5.53 Within Field 12 (16), which was located on the slope immediately to the west of Shenley Farm, the LiDAR survey shows ridge and furrow earthworks on a north-west to south-east alignment (Figs 2 and 4). Test Pit 5 was located on a ridge near the centre of the field and Trench 33 investigated an earthwork at its northern edge.

### **Test Pit 5**

- 5.54 The geological substrate was encountered at a depth of between 0.40m and 0.49m bgl (Fig. 30) and comprised firm, mid brownish orange silty clay (504). This was overlain by a 0.34m thick layer of firm, mid greyish brown clayey silt subsoil that was excavated in three spits (503 lower, 502 middle, 501 upper). The subsoil was sealed by a 0.14m thick layer of topsoil/turf (500).

### **Trench 33**

- 5.55 The trench was located c. 40m north-west of Shenley Farm, partly over a mound shown on the LiDAR imagery; on the ground, it was apparent that this was a modern spoil heap associated with the farm.
- 5.56 The geological substrate was soft, light reddish and greyish brown clay (3304), the surface of which was encountered at 0.42m below the original ground level (Fig. 31). It was overlain by a 0.18m thick deposit of soft, dark reddish brown silty clay subsoil (3303) that in the area of the mound was overlain in turn by two deposits of modern made ground (3302 and 3301) that had a combined thickness of up to 0.35m. The

mound was covered by a layer of redeposited topsoil (3300) with a thickness of c. 0.15m.

### **Field 13**

- 5.57 Field 13 (51) comprised a narrow strip of land immediately to the south of Shenley Farm, which prior to the construction of the adjacent motorway would have formed part of a much larger field (Figs 2 and 5). Due to its narrow width it had had limited agricultural use and had been used as an access track to fields south of the farm. The margins of the track had become overgrown and covered in scrub, and in places they had been used to dump building waste. The western boundary of the field was formed by a well-established, thick hedgerow and the ground was seen to drop down by c. 1m into the adjacent field to the west.

### **Trench 22**

- 5.58 This trench was excavated to investigate a possible carriageway which ran between Crick and Lilbourne, with a cross roads at Shenley Farm. The carriageway is shown on Eyre's map of 1779, a Map of Crick Parish of 1800-1820 and on an Ordnance Survey Drawing of 1817 (CgMs 2012, figs 2–4). From the late 19th century maps tend to show the carriageway reduced to a trackway to the south of Shenley Farm and footpath to the north of Shenley Farm (*ibid*, figs 5–6).
- 5.59 The geological substrate was soft, light reddish brown and light bluish grey clay (2203), the surface of which lay between 0.28m and 0.71m bgl (Fig. 32). It was overlain by up to 0.22m of soft to friable, dark reddish brown silty clay subsoil (2202). The subsoil was truncated by ditch 2204, which was aligned north-north-west to south-south-east, parallel to the hedgerow, and measured 2.5m wide by 0.36m deep. It had moderately sloping, concave sides, a concave base and its fill (2205) comprised firm, mid brownish grey silty clay. The ditch, possibly the flanking ditch of the carriageway mentioned above, was sealed by topsoil (2200/2201).

## 6. THE FINDS

- 6.1 Small quantities of artefactual material, comprising pottery, ceramic building material and worked flint, were recorded from five deposits or as unstratified finds. All material was material was recovered by hand. The pottery and other finds are listed by context number in Appendix B and discussed below.

### ***Pottery***

- 6.2 Pottery amounting to five sherds (33g) was recorded. One small and unfeatured sherd in an iron-rich handmade fabric from subsoil/ridge deposit 3401 is tentatively suggested as of late prehistoric (Iron Age) date. This, together with an abraded sherd of samian of earlier Roman (2nd century) date from subsoil/ridge layer 202 are clearly re-deposited finds. The remaining sherds, from subsoil/ridge deposits 202 and 1501, and an unstratified sherd, all date to the medieval period. All sherds are abraded and where present glaze is well-weathered. The medieval fabrics comprise glazed sandy whitewares of Midlands (Nuneaton/Chilvers Cotton type) and dateable across the mid 13th to 14th centuries (Soden and Ratkai 1998, 157–65), and unglazed, oxidised-fired sandy fabric (deposit 1501), probably of similar dating.

### ***Lithics***

- 6.3 A single worked flint flake was recorded from tree throw 206 (fill 207). It is a tertiary removal, without secondary working, in unpatinated grey/brown flint. It is clearly hard-hammered struck and shows no evidence of platform preparation, probable indications of later Neolithic or Bronze Age dating.

### ***Ceramic Building Material (CBM)***

- 6.4 One abraded fragment of ceramic tile was recorded from furrow 3504 (fill 3505). The fragment is flat but otherwise unfeatured and post-medieval or modern dating is suggested based on its very hard, red-fired fabric.

### ***Other finds***

- 6.5 Two (offcut) lead sheet fragments of unknown date or function were recorded from subsoil/ridge layer 202.

## 7. THE BIOLOGICAL EVIDENCE

### ***Animal bone***

- 7.1 Animal bones, consisting of a fragmented horse (*Equus caballus*) scapula (205g) and the vertebra of a cattle-size mammal (46g), were recovered from deposit 3104, the fill of ditch 3103. There was no direct association with datable artefacts and the bone, though well-preserved, displayed surface erosion consistent with exposure to the elements. The combination of these factors suggests that the bone is more than likely residual in nature.

### ***Palaeoenvironmental evidence***

- 7.2 Two environmental samples (40 litres of soil) were retrieved from two deposits with the intention of recovering evidence of industrial or domestic activity and material for radiocarbon dating. The samples were processed by standard flotation procedures (CA Technical Manual No. 2).

### ***Undated***

- 7.3 Sample 1 was recovered from fill 3405 within ditch 3404 and contained no plant macrofossils and only two fragments of moderately well-preserved charcoal, identifiable as oak (*Quercus*). In addition, small amounts of hand collected charcoal were recorded from ridge deposit 3401 and buried soil 3402. Fill 1406 within ditch 1405 (sample 2) contained no plant macrofossils and three fragments of very poorly preserved, silt-encrusted charcoal which was unidentifiable.

- 7.4 The paucity and poor preservation of this ecofactual material suggests it is residual, originating from wind-blown hearth debris. No further interpretation of site activities is possible. In addition to the residual nature of the charcoal material, the identification of solely oak means no material is suitable for radiocarbon dating.

### ***Pollen analysis***

- 7.5 Pollen analysis was carried out on eight sub-samples extracted at regular intervals from the monolith sample taken from test pit TP1. The monolith (0.5m) spanned the soil sequence from the alluvium in the base of the trench, through the overlying buried soil horizon (palaeosol) and extended into the subsoil that formed the ridge targeted by the test pit.

7.6 The results of the pollen analysis are presented in full in the report prepared by QUEST, University of Reading (Banerjea and Batchelor 2016; see Appendix D). In brief, the assessment of the sub-samples indicated a very low concentration of pollen grains and their preservation was poor. The pollen assemblage was relatively consistent across all eight sub-samples and largely comprised herbaceous taxa, including grasses, cereals and species associated with cultivation. Tree/shrub pollen was barely represented and aquatic pollen was entirely absent. The assessment concluded that the palaeosol was unlikely to be boreal in origin, although there was a possibility that pollen associated with cultivated land had been washed down the soil profile, lending a certain degree of uncertainty to this conclusion.

## 8. GEOARCHAEOLOGICAL ASSESSMENT

8.1 Geoarchaeological advice on the project was provided by Nick Watson, ARCA (University of Winchester), and included two site visits during the course of the fieldwork to assess deposits in selected test pits and trenches for the presence of a buried soil horizon below the mineralised medieval ploughsoil (subsoil). Remnants of a buried soil were identified in three test pits and five trenches so a programme of soil sampling was carried out for pollen and micromorphological analysis and to recover charred plant remains for radiocarbon dating. The sampling programme comprised two monolith samples taken from test pits TP1 and TP2, a 40 litre bulk soil sample taken from a ditch sealed by the buried soil in Trench 34 and a second bulk soil sample taken from a boundary ditch in Trench 14. The results of the geoarchaeological and micromorphological assessments are presented in full in the report prepared by ARCA, University of Winchester (Watson 2016; see Section 7 above and Appendix D).

8.2 Assessment of the samples and on-site investigation concluded that the buried soil (palaeosol) had some features characteristic of a Boreal soil, although pollen grains recovered from its base, which may be intrusive, were more indicative of a cultivated soil. Although some charcoal was recovered from a ditch sealed by the palaeosol, it was not suitable for radiocarbon dating so a date indicating the age of the soil horizon could not be ascertained. However, given the presence of archaeological features below the buried soil, which probably date to the Iron Age or Roman periods, it is most likely to date to the first millennium AD, predating the inception of the medieval open field system.

## 9. DISCUSSION

- 9.1 The ridge and furrow investigation sought to address the project's research objectives by examining and recording the archaeological and sedimentological sequence within an array of test pits and trenches that targeted selected earthwork features shown on a LiDAR survey of the site (CA 2015, figs 6.2 and 6.4). The research objectives have all been addressed to some degree, although interpretation of the results has been constrained by the lack of artefactual dating evidence and the paucity of organic material suitable for radiocarbon dating. The results will be assessed and incorporated into a synthesised report and critique, which will also review the results of the desk-based assessment prepared by CA (2015) and the DIRFT III excavations (CA 2017).
- 9.2 The excavations revealed evidence of land surfaces, natural features (e.g. tree root hollows) and activity pre-dating the establishment of the ridge and furrow system, and limited evidence for changes to the ridge and furrow system during its period of active use and following Enclosure. This section discusses the evidence from the archaeological investigation in chronological order whilst also considering this evidence in terms of the research objectives and assessing the extent to which each of these has been addressed.

### ***Alluvial deposits and palaeochannels***

- 9.3 British Geological Survey data on superficial deposits (BGS 2016) indicates that the northern and western parts of the site contain Pleistocene river terrace gravels overlain by alluvial deposits associated with the basin of Clifton Brook; no superficial deposits are mapped in the central and south-eastern parts of the site. However, evidence was encountered for superficial deposits of glacial till on the north-west facing slope below Shenley Farm, in the south-eastern part of the site, with more complex sequences exposed at the base of the slope at the interface between deposits of glacial and alluvial origin (Nick Watson pers. comm.). On the floodplain the geological substrate conformed to the mapped deposits and typically comprised alluvial clay, silt, sand and gravel, with the finer particle sized sediments predominating.
- 9.4 One of the considerations in deciding the locations of the trenches and test pits was to investigate areas of ridge and furrow that had been established on the flood plain or at its margins (Research Objective 5), where the geological substrate comprised

terrace gravels or fine-grained alluvium (Trenches 4, 6–8, 10–12, 14, 17a and test pits TP1–3). Possible palaeochannels within the floodplain were also targeted to recover palaeoenvironmental evidence that may indicate past land use. Due to extensive flooding over the western half of the site, many of the trenches in this area had to be relocated eastwards and only two trenches were excavated in their original positions (Trenches 7 and 12a). To compensate for this, three additional trenches were excavated on the flood plain in the northern part of the site (Trenches 34–36) and Trench 10 was extended to investigate a possible palaeochannel shown on the LiDAR survey at the southern edge of the floodplain.

- 9.5 No evidence was encountered for the palaeochannel and it seems likely that this feature is geomorphological in origin, demarcating the interface between the alluvial and glacial deposits at the base of the slope below Shenley Farm. This interpretation was supported by the examination of deposits in the extension of Trench 10, which revealed fine-grained alluvium interbedded with fine-grained clay containing small, angular stone clasts typically found in glacial till.

#### ***The pre-open field system landscape***

- 9.6 On the floodplain in the northern part of the site, the investigation revealed an intermittent buried soil horizon beneath the mineralised medieval ploughsoil (subsoil). Shallow irregular hollows, probably formed by tree throw and root disturbance, were evident beneath the buried soil, suggesting that the floodplain supported some tree cover prior to clearance for agricultural use. The buried soil had certain characteristics of a Boreal (i.e. Mesolithic/Neolithic) soil, but it was found to overlie features of probable Iron Age or Roman date, so is likely to have formed during the first millennium AD. Pollen analysis suggested that the deposit was a cultivated soil as it contained herbaceous taxa, including grasses, cereals and species associated with cultivation, with tree/shrub pollen barely represented and aquatic pollen entirely absent. However, the pollen analysis was inconclusive as there was a possibility that the pollen of species associated with cultivation may have been intrusive.
- 9.7 Investigation of the transition from the Roman agricultural system to the medieval open field system and the influence earlier landscape features had on its layout were two of the project's research objectives (Research Agenda 1 and 8), so the archaeological features identified beneath the buried soil had the potential to contribute to an understanding of how the layout of the open field system was

influenced by earlier landscape features. The archaeological features encountered by the investigation comprised occasional small ditches that probably formed field boundaries of Late Iron Age or Roman date, similar to those investigated nearby during the recent excavations within the site (CA forthcoming). Their alignment varied significantly from that of the blocks of ridge and furrow, suggesting that the layout of the open field system did not respect earlier land boundaries to any degree, assuming that they were still visible in the landscape after centuries of abandonment (Research Agenda 8). Based on the excavated evidence, Watling Street and Clifton Brook remain the primary landscape features that influenced the layout of the medieval open field system.

### ***Origin and development of the open field system***

- 9.8 The ridge and furrow earthworks have been comprehensively mapped by the LiDAR survey carried out for the Stage 1 ridge and furrow assessment prepared by CA (2015). This concluded that the open field system probably dates from the end of the first millennium AD and remained in use for over five hundred years, until economic changes led to it being turned over to pasture.
- 9.9 To maximise the recovery of artefactual material from the medieval ridges targeted by the test pits, the subsoil forming the ridges (and any buried soil below the subsoil) was hand-excavated in spits. It was envisaged that sherds of pottery recovered from the ridges would contribute towards the study of manuring patterns being used in the medieval period (Research Agenda 7). However, the results were poor, with only four sherds of late prehistoric, Roman and medieval pottery being recovered from the mineralised ploughsoil that formed the ridges.
- 9.10 The general paucity of artefactual dating evidence from stratified deposits and the low occurrence of suitable carbonised material in the soil samples also limited attempts to investigate the chronology of the open field system and any subsequent alterations to its layout (Research Agenda 10). Determining the stratigraphic relationship between earthwork features shown on the LiDAR survey was also constrained by the homogenous nature of the mineralised ploughsoil soil that formed the earthworks. However, there was some indication that the open field system did evolve during its period of active use, including the reorganisation of blocks of ridge and furrow (Trench 35).



- 9.11 Analysis of pollen recovered from the mineralised medieval plough soil and buried soil horizon demonstrated a very low concentration of poorly preserved pollen grains. The pollen assemblage was relatively consistent and largely comprised herbaceous taxa, including grasses, cereals and species associated with cultivation, with tree/shrub pollen barely represented (Research Agenda 11).

#### ***Conversion to pasture and later land use***

- 9.12 Exploitation of the open field system continued into the post-medieval period and large tracts of the remnant landscape were subsequently preserved once Rugby Radio Station had been established. However, there was some evidence for landscape utilisation and modification following the abandonment of the open field system. Field drains of relatively recent origin were recorded widely across the site and in Trench 11 a modern ditch truncated the ridge and furrow. This feature was clearly visible on the surface and on the LiDAR imagery and was interpreted in the ridge and furrow assessment as a post-medieval boundary (CA 2015, fig. 6.2).
- 9.13 Elsewhere, post-open field exploitation of the landscape has manifested itself in the variable level of truncation of the ridge and furrow, which was previously discussed in the ridge and furrow assessment (CA 2015, fig. 6.7), areas of poor preservation probably having been subjected to greater levels of post-medieval ploughing.

## **10. CA PROJECT TEAM**

- 10.1 The fieldwork was undertaken by Peter Boyer, assisted by James Coyne, Mathieu Ferron, Luis Gomes, Michael Hughes, Alice Krausova, Dan Riley, Callum Ruse, Jake Streatfeild-James and Andy Whelan. The report was written by Peter Boyer, with contributions from Katie Marsden (finds), Andy Clarke (animal bone) and Sarah Cobain (charred plant material), and the illustrations were prepared by Sam O'Leary. Specialist on-site advice and the geoarchaeological report was provided by Nick Watson (ARCA, University of Winchester) and pollen and soil micromorphology assessment was provided by Rowena Banerjea and Rob Batchelor (QUEST, University of Reading). The archive has been compiled by Emily Evans and prepared for deposition by Jessica Cook. The project was managed for CA by Simon Carlyle.

## 11. REFERENCES

BGS (British Geological Survey) 2016 [www.bgs.ac.uk/geoindex](http://www.bgs.ac.uk/geoindex), accessed 8 April 2016

CA (Cotswold Archaeology) 2015 Daventry International Rail Freight Terminal III (DIRFT III), Northamptonshire: *Ridge and Furrow Assessment (Stage 1)*, CA Report No. **15622**

CA (Cotswold Archaeology) 2016 *DIRFT III Ridge and Furrow Survey, Northamptonshire: Written Scheme of Investigation for an Archaeological Evaluation*

CA (Cotswold Archaeology) 2017 *Daventry International Rail Freight Terminal III (DIRFT III), Northamptonshire, Strip, Map & Sample Excavations: Post-Excavation Assessment Report and Updated Project Design*

CgMs (CgMs Consulting) 2012 *Heritage Assessment: DIRFT III, Northamptonshire*, report **SD/10513**

DCLG (Department for Communities and Local Government) 2012 *National Planning Policy Framework*

Foard, G, 2006a *East Midlands Archaeological Research Framework: An Archaeological Resource Assessment of Anglo-Saxon Northamptonshire 400-1066*

Foard, G, 2006b *East Midlands Archaeological Research Framework: An Archaeological Resource Assessment of Medieval Northamptonshire*

Gloucestershire County Council 2012 *Turning the Plough Update Assessment 2012*

Hall, D, 2014 *The Open Fields of England*

Hughes, G, and Woodward, A, 2015 *The Iron Age and Romano-British Settlement at Crick Covert Farm Excavations 1997-1998 (DIRFT Volume I)*, Oxford: Archaeopress

Masefield, R (ed), Chapman, A, Ellis, P, Hart, J, King R and Mudd, A, 2016 *Origins, Development and Abandonment of an Iron Age Village Further Archaeological Investigations for the Daventry International Rail Freight Terminal, Crick & Kilsby, Northamptonshire 1993-2013 (DIRFT Volume II)*, Oxford: Archaeopress

MoLA (Museum of London Archaeology) 2015a *Historic Building Recording at Rugby Radio Station, B Building, Lilbourne, Northamptonshire, May 2015, DIRFT III*, report **15/125**

MoLA (Museum of London Archaeology) 2015b *Historical Building Recording at Shenley Farm, Crick, Northamptonshire*, report **15/147**

Northamptonshire County Council 2001 *Turning the Plough*

Partida, T, Hall, D, and Foard, G, 2013. *An Atlas of Northamptonshire: The Medieval and Early Modern Landscape*, Oxford: Oxbow

Soden, I. and Ratkai, S. 1998 *Warwickshire Medieval and Post Medieval Type Series*, Warwickshire Museum

## APPENDIX A: CONTEXT DESCRIPTIONS

Context no.	Type	Context Interpretation	Context Description	L (m)	W (m)	D/T (m)	Spot Date
<b>Test pit TP1</b>							
100	Layer	Topsoil	Friable dark brown grey silty loam <1% small angular stones	>3	>2	0.23	
101/ 102	Layer	Subsoil	Soft mid grey brown silty clay <1% small angular stones	>3	>2	0.19	
103/ 104	Layer	Buried soil	Firm dark blue grey silty clay, <1% small angular stones and <1% charcoal flecks	>3	>2	0.26	
105	Layer	Geology	Firm light yellow orange with blue mottling clay	>3	>2		
106	Cut	Ditch	NE-SW linear, straight moderate sides and flat base	>1	0.83	0.2	Undated
107	Fill of 106	Secondary silting	Firm mid blue grey silty clay, <1% small angular stones and <1% charcoal flecks	>1	0.83	0.2	
<b>Test pit TP2</b>							
200	Layer	Topsoil	Friable dark brown grey silty loam <1% small angular stones	>3	>2	0.2	
201/ 202	Layer	Subsoil	Soft mid grey brown silty clay <1% small angular stones	>3	>2	0.22	
203	Layer	Buried soil	Friable dark grey brown sandy clay, 5% sub angular/rounded small stones	>3	>2	0.17	
204	Cut	Tree throw	Sub circular, concave gently sloping sides and flattish base	>1.47	0.83	0.1	
205	Fill of 204	Secondary silting	Friable dark brown grey silty clay	>1.47	0.83	0.1	
206	Cut	Tree throw	Sub circular, concave gently sloping sides and flattish base	>0.86		0.11	
207	Fill of 206	Secondary silting	Friable dark brown grey silty clay	>0.86		0.11	
208	Layer	Geology	Firm light yellow brown sandy clay	>3	>2		
<b>Test pit TP3</b>							
300	Layer	Topsoil	Friable dark brown grey clay loam <1% small angular/rounded stones	>3	>2	0.15	
301/ 302	Layer	Subsoil	Soft mid grey brown silty clay <1% small angular stones and <1% charcoal flecks	>3	>2	0.24	
303/ 304	Layer	Buried soil	Firm mid blue grey silty clay, <1% small angular stones and <1% charcoal flecks	>3	>2	0.19	
305	Layer	Geology	Firm mid yellow orange clay with grey gravel inclusions	>3	>2		
<b>Test pit TP4</b>							
400	Layer	Topsoil	Friable dark grey brown clay loam <1% small stones	>3	>2	0.3	
401/ 402/ 403	Layer	Subsoil	Firm light brown grey silty clay <1% small stone inclusions	>3	>2	0.32	
404	Layer	Geology	Firm mid yellow orange clay with grey gravel inclusions	>3	>2		
405	Cut	Ditch terminus	N-S linear with rounded end and straight gently sloping sides and flat base	>0.92	0.8	0.7	Undated
406	Fill of 405	Secondary silting	Firm light brown grey silty clay <1% small stone inclusions	>0.93	0.8	0.7	
407	Cut	Tree throw	Irregular in plan with shallow concave sides and irregular base	0.9	1.33	0.13	
408	Fill of 407	Secondary silting	Firm mid red brown coarse sandy gravels frequent iron panning	0.9	1.33	0.13	
<b>Test pit TP5</b>							
500	Layer	Topsoil	Friable dark grey brown clayey silt <1% small stone inclusions	>3	>2	0.14	
501	Layer	Subsoil	Firm mid grey brown clayey silt <1% small stone inclusions	>3	>2	0.1	
502	Layer	Subsoil	Firm mid grey brown clayey silt <1% small stone inclusions	>3	>2	0.1	
503	Layer	Subsoil	Firm mid grey brown clayey silt <1% small stone inclusions	>3	>2	0.14	
504	Layer	Geology	Firm mid brown orange silty clay <1% small stone inclusions	>3	>2		

Trench 4							
4000	Layer	Topsoil	Friable mid brown grey clayey silt <1% small stone inclusions	>10	>4	0.3	
4001	Layer	Subsoil	Firm light orange grey clay silt <1% small stone inclusions	>10	>4	0.12	
4002	Layer	Geology	Firm mid grey brown clay <1% small stone inclusions	>10	>4		
Trench 6							
600	Layer	Topsoil	Soft mid brown grey clay silt <1% small stone inclusions	>10	>4	0.47	
601	Layer	Geology	Firm mid brown orange clay <1% small stone inclusions	>10	>4		
602	Cut	Service trench	Linear cut for modern service	>10	1.2		Modern
603	Fill of 602	Fill	Firm mid brown grey clay silt >5% medium/large stone inclusions	>10	1.2		
Trench 7							
700	Layer	Topsoil	Friable dark grey brown clay silt <1% small stone inclusions	>10.7	>5.1	0.25	
701	Layer	Subsoil	Firm mid grey brown silt clay <1% small stone inclusions	>10.7	>5.1	0.25	
702	Layer	Geology	Firm mid brown orange silt clay >5% small stone inclusions	>10.7	>5.1		
Trench 8							
800	Layer	Topsoil	Soft light brown grey clay silt <1% small stone inclusions	>10	>4	0.26	
801	Layer	Subsoil	Soft light orange grey silt clay <1% small stone inclusions	>10	>4	0.22	
802	Layer	Geology	Firm light brown grey gravel/ light grey yellow clay <1% small stone inclusions	>10	>4		
803	Cut	Furrow	NW/SE aligned furrow	>4	1.32	0.22	
804	Fill of 803	Secondary silting	Soft mid grey brown silty clay <1% small stone inclusions	>4	1.32	0.22	
805	Cut	Tree throw	Large irregular feature	>6	>2.8	0.3	
806	Fill of 805	Secondary silting	Firm dark brown grey clay silt <1% small stone inclusions	>6	>2.8	0.3	
Trench 10							
1000	Layer	Topsoil	Firm dark grey brown clay silt <1% small stone inclusions	>40	>2	0.2	
1001	Layer	Subsoil	Firm mid grey brown clay silt <1% small/medium stone inclusions	>20	>2	0.25	
1002	Layer	Geology	Firm dark brown grey silt clay <1% small stone inclusions	>5	>2	0.38	
1003	Layer	Geology	Firm light yellow brown clay <1% small stone inclusions	>40	>2		
Trench 11							
1100	Layer	Topsoil	Friable dark brown grey silt clay	>10	>4	0.27	
1101	Layer	Subsoil	Firm mid grey brown silt clay <1% small stone inclusions	>10	>4	0.24	
1102	Layer	Geology	Stiff light orange brown sand clay	>10	>4		
1103	Cut	Tree throw	Sub-circular, concave sides, flattish base	1.01	>0.7	0.09	
1104	Fill of 1103	Secondary silting	Firm dark brown grey silty clay	1.01	>0.7	0.09	
1105	Cut	Tree throw	Sub-circular, asymmetric profile, flattish base	0.93	0.75	0.15	
1106	Fill of 1105	Secondary silting	Firm dark red grey silty clay	0.93	0.75	0.15	
1107	Cut	Tree throw	Sub-circular, irregular sides, flattish base	0.83	0.79	0.22	
1108	Fill of 1107	Secondary silting	Firm dark red grey silty clay	0.83	0.79	0.22	
1109	Cut	Ditch	E/W aligned, concave sides, flat base	>1	0.94	0.34	Post-med/modern
1110	Fill of 1109	Secondary silting	Firm mid brown grey silty clay <1% small stone inclusions	>1	0.94	0.34	
Trench 12							

1200	Layer	Topsoil	Soft mid grey brown silt <1% small stone inclusions	>10.1	>5	0.27	
1201	Layer	Subsoil	Firm mid brown grey clay silt <1% small stone inclusions	>10.1	>5	0.27	
1202	Layer	Geology	Firm light brown yellow silty sand	>10.1	>5	>0.21	
<b>Trench 14</b>							
1400	Layer	Topsoil	Soft dark brown silty clay <1% small stone inclusions	>10	>4	0.2	
1401	Layer	Subsoil	Soft mid red brown silt <1% small stone inclusions	>4	3.55	0.2	
1402	Layer	Subsoil	Soft light red brown silt <5% small sub-angular stones	>6	>4	0.4	
1403	Layer	Buried soil	Firm mid red brown silty clay moderate manganese staining	>6	>4	0.2	
1404	Layer	Geology	Firm mid yellow brown clay	>10	>4		
1405	Cut	Ditch	NW/SE aligned, straight sides, concave base	>4	0.7	0.3	Undated
1406	Fill of 1405	Secondary silting	Soft mid red brown silt clay abundant manganese staining	>4	0.7	0.3	
1407	Cut	Ditch	Modern E/W aligned boundary ditch	>4	1.2	0.4	Post-med/modern
1408	Fill of 1407	Secondary silting	Soft dark grey brown clayey silt	>4	1.2	0.4	
<b>Trench 15</b>							
1500	Layer	Topsoil	Soft very dark grey clayey silt <1% small stone inclusions	>20	>20	0.14	
1501	Layer	Subsoil	Soft dark red brown silty clay <1% small stone inclusions	>20	>20	0.1	
1502	Layer	Alluvium	Soft mid green brown silty clay <2% small/medium stone inclusions	>20	>20	0.1	
1503	Layer	Geology	Soft light to mid red brown/ blue grey clay <2% small/ medium stone inclusions	>20	>20		
1504	Cut	Ditch	E/W aligned, concave sides and base	10.1	0.45	0.09	Undated
1505	Fill of 1504	Secondary silting	Soft mid grey/red brown silty clay <2% small/medium stone inclusions	10.1	0.45	0.09	
1506	Cut	Posthole	Sub-circular, concave sides and base	0.45	0.35	0.1	Undated
1507	Fill of 1506	Secondary silting	Soft mid red brown silty clay <1% small stone inclusions	0.45	0.35	0.1	
1508	Cut	Ditch terminus	E/W aligned, concave sides and base	0.3	0.45	0.08	Undated
1509	Fill of 1508	Secondary silting	Soft mid grey/red brown silty clay <2% small/medium stone inclusions	0.3	0.45	0.08	
<b>Trench 17a</b>							
1700	Layer	Topsoil	Soft dark brown grey clay silt <1% small stone inclusions	>20	>2	0.29	
1701	Layer	Subsoil	Soft mid orange brown clayey silt <1% small stone inclusions	>20	>2	0.33	
1702	Layer	Geology	Firm mid brown grey gravel/ orange yellow clay	>20	>2		
1703	Layer	Headland material	Firm dark brown grey clayey silt <1% small stone inclusions	>5.8	>2	0.2	
1704	Layer	Buried soil	Firm dark brown grey silty clay <1% small stone inclusions	>2	>1	0.2	
1705	Cut	Modern truncation	Modern surface depression	0.2	1.65	0.17	
1706	Fill of 1705	Secondary silting	Soft dark grey brown clayey silt	0.2	1.65	0.17	
1720	Layer	Topsoil	Friable dark grey brown sandy silt <2% small stone inclusions	>41	>2	0.2	
1721	Layer	Subsoil	Firm mid grey brown silty clay	>41	>2	0.45	
1722	Layer	Geology	Firm mid brown orange clayey silt >5% small stone inclusions	>41	>2		
1723	Layer	Buried soil	Firm mid brown grey silty clay <1% small stone inclusions	>2	>1.9	0.2	
1724	Cut	Furrow	E/W aligned, concave sides, flat base	>2	2.21	0.3	Medieval
1725	Fill of 1724	Secondary silting	Firm mid brown grey clayey silt <1% small stone inclusions	>2	2.21	0.3	

Trench 17b							
1750	Layer	Topsoil	Friable mid grey brown silty clay	>10	>4	0.32	
1751	Layer	Subsoil	Firm light grey brown clay	>10	>4	0.1	
1752	Layer	Geology	Firm mid yellow blue clay and red gravel patches	>10	4		
1753	Cut	Ditch terminus	N/S aligned, concave sides, flat base	>3	0.74	0.26	
1754	Fill of 1753	Secondary silting	Soft light yellow brown silty clay >2% small stone inclusions	>3	0.74	0.26	
Trench 22							
2200	Layer	Topsoil	Friable dark grey brown clayey silt <2% small/medium stone inclusions	>5	>4.5	0.32	
2201	Layer	Topsoil	Friable dark grey brown/very dark grey clayey silt <2% small stone inclusions, heavy rooting	>4	>4.5	0.7	
2202	Layer	Subsoil	Soft/friable dark red brown silty clay <2% small stone inclusions	>14.2	>4.5	0.22	
2203	Layer	Geology	Soft light red brown/blue grey clay <2% small/medium stone inclusions	>14.1	>4.5		
2204	Cut	Ditch	NW/SE aligned, concave sides, flat base	>4.5	2.5	0.36	Undated
2205	Fill of 2204	Secondary silting	Firm mid brown grey silty clay	>4.5	2.5	0.36	
Trench 24							
2400	Layer	Topsoil	Friable mid brown grey clayey silt <2% small/medium stone inclusions	>11	>4.4	0.26	
2401	Layer	Subsoil	Friable/soft dark red brown silty clay <2% small/medium stone inclusions	>11	>4.4	0.2	
2402	Layer	Geology	Friable/soft dark blue grey/ light red brown clay >5% small/medium stone inclusions	>11	>4.4		
2403	Cut	Animal burrow	Large irregular feature, irregular sides and base	>4.4	1.01	0.3	
2404	Fill of 2403	Fill	Friable light red brown clayey sand >5% small/medium stone inclusions	>4.4	1.01	0.3	
Trench 25							
2500	Layer	Topsoil	Friable very dark brown grey silty clay <2% small/medium stone inclusions	>12	>4	0.17	
2501	Layer	Subsoil	Firm mid yellow brown silty clay	>12	0.4	0.26	
2502	Layer	Geology	Firm light orange brown sandy clay	>12	0.4		
Trench 30							
3000	Layer	Topsoil	Soft dark grey brown clayey silt	>10	>4	0.22	
3001	Layer	Subsoil	Friable mid grey brown clay silt >5% small stone inclusions	>10	>4	0.2	
3002	Layer	Geology	Firm mid brown orange gravel	>10	>4		
3003	Cut	Furrow	E/W aligned, concave sides and base	>2	1.34	0.28	Medieval
3004	Fill of 3003	Secondary silting	Friable mid brown grey silty clay <1% small stone inclusions	>2	1.34	0.28	
3005	Cut	Natural depression	Sub-circular, steep sides, flat base	>5.5	>2.2		
3006	Fill of 3005	Geology silting	Firm mid grey brown clayey silt >2% small stone inclusions	>5.5	>2.2		
Trench 31							
3100	Layer	Topsoil	Friable dark brown grey silty clay <2% small stone inclusions	>50	>2.36	0.25	
3101	Layer	Subsoil	Firm light brown grey silty clay <1% small/medium stone inclusions	>50	>2.36	0.36	
3102	Layer	Geology	Firm light red brown sandy clay	>50	>2.36		
3103	Cut	Ditch	NW/SE aligned, concave sides, flat base	>2.36	2.02	0.54	Undated
3104	Fill of 3103	Secondary silting	Firm light brown grey silt clay <1% small stone inclusions	>2.36	2.02	0.54	
Trench 32							
3200	Layer	Topsoil	Friable mid grey brown clayey silt <1% small/medium stone inclusions	>10.5	>5	0.18	

3201	Layer	Subsoil	Soft dark red brown silty clay <1% small stone inclusions	>10.5	>5		
3202	Layer	Geology	Soft dark blue grey/red brown clay <1% small/medium stone inclusions	>10.5	>5		
3203	Cut	Geological feature	Large irregular feature	>4.45	>2.84		
3204	Fill of 3203	Geology silting	Soft mid red brown clay <2% small/medium stone inclusions	>4.45	>2.84		
<b>Trench 33</b>							
3300	Layer	Topsoil	Soft mid grey brown clayey silt <1% small/medium stone inclusions	>11	>5	0.16	
3301	Layer	Deposit	Soft mottled mid yellow brown/ mid grey brown silty clay <2% small/medium stone inclusions	>11	>5	0.18	Modern
3302	Layer	Deposit	Soft mid red brown silty clay <2% small/medium stone inclusions	>11	>5	0.12	Modern
3303	Layer	Subsoil	Soft dark red brown silty clay <1% small stone inclusions	>11	>5	0.18	
3304	Layer	Geology	Soft light red/grey brown clay <1% small stone inclusions	>11	>5		
<b>Trench 34</b>							
3400	Layer	Topsoil	Friable dark grey brown clayey silt <1% small stone inclusions	>20.3	>2.2	0.2	
3401	Layer	Subsoil	Firm mid orange brown silt clay <5% small stone inclusions	>20.3	>2.2	0.32	
3402	Layer	Buried soil	Soft mid brown grey clayey silt <1% small stone inclusions	>20.3	>2.2	0.24	
3403	Layer	Geology	Soft light red brown/mid green grey clay and friable dark red brown clayey sand <5% small/medium stone inclusions	>20.3	>2.2		
3404	Cut	Ditch	NW/SE aligned, concave sides, flat base	>2	0.76	0.23	Undated
3405	Fill of 3404	Secondary silting	Soft dark grey brown silty clay <5% small/medium stone inclusions	>2	0.76	0.23	
<b>Trench 35</b>							
3500	Layer	Topsoil	Soft/friable mid grey brown clayey silt <1% small/medium stone inclusions	>18.5	>2.2	0.3	
3501	Layer	Subsoil	Friable/soft mid/dark red brown sandy clay <1% small/medium stone inclusions	>18.5	>2.2	0.26	
3502	Layer	Buried soil	Soft/friable mid greyish brown clayey silt <1% small stone inclusions	>18.5	>2.2	0.16	
3503	Layer	Geology	friable light/mid red brown clayey sand and soft mid green grey clay <5% small/medium stone inclusions	>18.5	>2.2		
3504	Cut	Furrow	N/S aligned, convex sides	>2.2	1.95		Medieval
3505	Fill of 3504	Secondary silting	Friable dark red brown clayey sand <1% small/medium stone inclusions	>2.2	1.95		
3506	Cut	Furrow	N/S aligned, convex sides	>2.2	1.7		Medieval
3507	Fill of 3506	Secondary silting	Friable dark red brown clayey sand <1% small/medium stone inclusions	>2.2	1.7		
<b>Trench 36</b>							
3600	Layer	Topsoil	Soft dark grey brown silty clay <1% small/medium stone inclusions	>20	>2	0.2	
3601	Layer	Subsoil	Soft light red brown silty clay frequent manganese staining	>20	>2	0.3	
3602	Layer	Buried soil	Firm dark bluish grey clay	>20	>2	0.12	
3603	Layer	Geology	Firm light yellow brown clay <1% small stone inclusions	>20	>2		



**APPENDIX B: THE FINDS***Table 1: Quantification of finds by context*

<b>Context</b>	<b>Class</b>	<b>Description</b>	<b>Ct.</b>	<b>Wt.(g)</b>	<b>Spot-date</b>
Us.	Medieval pottery	Midlands (Nuneaton type) glazed whiteware	1	12	-
202	Medieval pottery	Midlands (Nuneaton type) glazed whiteware	1	9	C13-C15
	Roman pottery	Central Gaulish samian	1	5	
	Pb object	Sheet fragments	2	26	
207	Worked flint	Flake	1	3	-
3401	Prehist pottery	Ferruginous/organic fabric (FEo)	1	1	Lpre
3505	CBM	Flat roof tile	1	79	Pmed
1501	Medieval pottery	Unglazed sandy earthenware	1	6	C13-C15

*Summary fabric descriptions (Prehistoric pottery)*

FEo Black throughout. Soft, with finely irregular fracture and smooth feel. Contains abundant, well-sorted sub-rounded iron oxide (0.5-1mm) and sparse organic inclusions.

## APPENDIX C: THE PALAEOENVIRONMENTAL EVIDENCE

Table 1: Identified animal species by fragment count (NISP) and weight and context.

Cut	Fill	EQ	LM	Total	Weight (g)
3103	3104	1	1	2	251
Total		1	1	2	
Weight		205	46	251	

EQ = Horse; LM= cattle sized mammal

Table 2: Charcoal identifications

Context number			3401	3402	3405	1406
Feature number			-	-	3404	1405
Sample number (SS)					1	2
Flot volume (ml)			N/A	N/A	1.5	2
Sample volume processed (l)			N/A	N/A	20	16
Soil remaining (l)			N/A	N/A	20	20
Period			UD	UD	UD	UD
Charcoal quantity			+	+	+	+
Charcoal preservation			Good	Good	Moderate	Poor
Family	Species	Common Name				
Fagaceae	<i>Quercus petraea</i> (Matt.) Liebl./ <i>Quercus robur</i> L.	Sessile Oak/Pedunculate Oak	2	3	2	
		Indeterminate				3
<b>Total</b>			<b>2</b>	<b>3</b>	<b>2</b>	<b>3</b>

## **APPENDIX D: GEOARCHAEOLOGICAL REPORT (ARCA 2016)**

October 2016

Report Number: 1617-6

**GEOARCHAEOLOGICAL  
INVESTIGATION OF  
DEPOSITS AT THE  
DIRFT III SITE,  
NORTHAMPTONSHIRE**

Prepared for Cotswold  
Archaeology

Nick Watson

**ARCA**

Department of Archaeology  
University of Winchester  
Winchester  
SO22 4NR

<http://www.arcauk.com>

Version	Date	Status*	Prepared by	Author's signature	Approved by	Approver's Signature
01	20/10/16	E	Nick Watson			
*I – Internal draft; E – External draft; F - Final						

## **CONTENTS**

Figure list .....	1
Table list.....	1
Summary.....	2
1 Introduction .....	3
2 Geology and site context.....	3
3 Methodology .....	5
4 Results of the field work .....	7
5. Results of the laboratory work.....	10
5.1 Micromorphology.....	10
5.2 Pollen assessment.....	10
6. Conclusions and recommendations .....	11
7 Acknowledgments.....	11
8 Bibliography.....	11

## **FIGURE LIST**

Figure 1 North section of Trial Trench 1: position of Monolith 1. The palaeosol is visible in the lowest quarter of the section as a brownish grey unit. ....	5
Figure 2. (left) Trench 10 which sectioned the north bank of the Clifton Brook. Figure 3. (right) Probable alluvial deposits in the west section of Trench 10. ....	9

## **TABLE LIST**

Table 1. Description of the deposits. ....	7
Table 2. List of samples taken from Monolith 1.....	8

## **SUMMARY**

*In March 2016 ARCA sampled the sections of two trial trenches located in a ridge and furrow system in the vicinity of the Clifton Brook at the DIRFT III site, Northamptonshire. One monolith sample was assessed for pollen in the ridge material and the micromorphology of a possible palaeosol buried below the ridge was investigated. The deposits were heavily oxidized, inorganic silt/clays that only poorly preserved any pollen. The results indicated a very open, cultivated landscape of the historic period. The palaeosol had some features characteristic of a Boreal soil but its date could not be confirmed by an independent dating method, furthermore cereal pollen was present at its base although this may have been introduced.*

## **1 INTRODUCTION**

- 1.1 On 17<sup>th</sup> and 31<sup>st</sup> of March, at the request of Simon Carlyle of Cotswold Archaeology, ARCA carried out a geoarchaeological investigation of the stratigraphy exposed in archaeological trial trenches on the site of the Daventry International Rail Freight Terminal III (DIRFT III), Northamptonshire. The purpose of the trenches was to examine ridge and furrow earthworks. The site is located between Watling Street (the A5 trunk road) and north of Junction 18 of the M1 Motorway. It is centred on NGR: SP 5648 7540.
- 1.2 This document presents the results of the geoarchaeological investigation of the trial trenches. It is arranged as follows: first an account is provided of the local geology and site context, then the methodology is described, followed by the results, and finally conclusions and recommendations for further work complete the document. The laboratory report of samples taken during this work is reported on in 'DIRFT III Northamptonshire Micromorphology and Pollen Report' By Drs Rowena Banerjea and C.R. Batchelor and is attached to this document.
- 1.3 The report is intended to address the following aims:
  - 1.3.1 To investigate the Quaternary geology of the site and thus determine the depth and nature of any superficial sediments and the bedrock.
  - 1.3.2 To determine the relationship of the archaeological features to the superficial and bedrock geology. In particular any palaeosols that may have been preserved below the earthworks, and to establish their date.
  - 1.3.3 To select and sample any such palaeosols and the encompassing archaeological stratigraphy for palaeoenvironmental analysis (pollen) and micromorphological study.

## **2 GEOLOGY AND SITE CONTEXT**

- 2.1 The main topographical feature of the site is the broad river valley plain of the westerly draining, underfit Clifton Brook that springs 1km to the east. The valley lies at c.90m OD. To the southeast the land rises gently to Shenley Farm at c.115m OD. West of the farm by 1km lies the Crick Brook a tributary of the



Clifton Brook that drains to the north. Watling Street occupies its valley. Beyond the site to the north lies a ridge of high ground running southeast to northwest between Lilbourne and Rugby.

- 2.2 The British Geological Survey (BGS) map (1:50,000) the site as lying on the Charmouth Mudstone Formation of the Lias Group that dates from the Sinemurian to Pliensbachian Age of the Early Jurassic 199.3–182.7Ma (million years ago). The lithology is described as dark grey and blueish grey mudstones and laminated shales. Overlying the Charmouth Mudstone Formation in the interfluvium of the rivers, and tracing the 100m contour is a band of river terrace remains dating to the Quaternary Period that spans from 3Ma to the present day. The lithology is described as un lithified sands and gravels. Occupying the broad valley of the Clifton Brook are Holocene alluvial deposits that are described as firm and consolidated silt/clays with a desiccated and oxidized surface zone (BGS 2016a).
- 2.3 The BGS also maps mid Pleistocene Till, dated from the Cromerian to the Ipswichian Stages (c.563–115ka), on the high ground to the north of the site and at the head of the Clifton Brook. Till is recorded in two geotechnical boreholes that were drilled along the route of the M1 motorway prior to its construction (BGS 2016b). Borehole BGS SP57NE4 lies c.100m north of the Clifton Brook and recorded 0.46m of ‘blueish grey and yellowish brown soft clay with some small flints’ below the topsoil and overlying the weathered Charmouth Mudstone Formation. A second borehole (BGS SP57NE3) 300m south of the Brook recorded 0.76m of ‘yellow brown sandy clay with beads of chalk’ overlying the weathered Charmouth Mudstone Formation. Although not mapped as such, these records suggest there are deposits of till below the alluvium mapped across the Clifton Brook valley. The records also indicate that the top of the bedrock is relatively close to the surface, sub cropping at approximately 0.8–0.6m below the ground level.
- 2.4 It is noteworthy that the lithologies of the major geological units on the site – weathered Charmouth Mudstone Formation, Till and Alluvium – are so similar in texture (silt/clay) and colour (bluish greys and brownish grey when oxidized) that they are almost indistinguishable in the field in the shallow sections exposed in the trial trenches. For example, the fine grained mineralogenic alluvium that has been derived from erosion of the till and the mudstone within the short confines of the

watershed, may include fine clasts of chalk and flint, the very same lithologies that define the till.

### **3 METHODOLOGY**

- 3.1 The vertical sections of the Trial Trenches 1, 2 and 3 on the valley floor were inspected for evidence of palaeosol preservation. Two examples were selected, one in Trial Trench 1 and the other in Trial Trench 2. They were sampled using monolith tins that measured 500 x 50 x 50mm. The monolith tin was positioned vertically on the trench base and inserted into the section containing the palaeosol with judicious use of a lump hammer. The tins were extracted with their contained sediment, wrapped in cling film, labelled and transported to the ARCA laboratory at the University of Winchester for further analysis.
- 3.2 To determine the thickness and nature of deposits at the base of the Trial Trenches (described as 'the natural' in archaeological parlance), an Edelman soil auger with extension rods was employed and the sediment recovered was described according to standard geological criteria (Jones *et al* 1999; Tucker 2011).
- 3.3 In the laboratory both monolith samples were cleaned with a scalpel and photographed, and one (Monolith 1 from Trial Trench 1) was selected for palaeoenvironmental and micromorphological sub sampling (Figure1).



Figure 1 North section of Trial Trench 1: position of Monolith 1. The palaeosol is visible in the lowest quarter of the section as a brownish grey unit.

- 3.4 To provide evidence for the history of the vegetation and environmental conditions that pertained to the site in the past, eight pollen samples were extracted at regular intervals through the monolith. Although a palaeosol was believed to be present – evidence of which was dark humic silt/clay and a prismatic structure – a micromorphological sample was taken of the unit to determine its mode of formation and so confirm or reject the hypothesis. These samples were submitted for analysis to Quaternary Scientific (Quest), at the University of Reading.
- 3.5 To test for the presence of waterlogged deposits in the middle of the valley, a trench (Trench 10) was cut by machine perpendicular to the Clifton Brook and the deposits examined *in situ*.
- 3.6 The monoliths from Trial Trenches 1 and 2 are held in storage at the ARCA Laboratory at the University of Winchester. Digital data (photographs) are held on the University of Winchester server. No artefacts were recovered.

**4 RESULTS OF THE FIELD WORK**

<i>Monolith 1 Trial Trench 1</i>	<i>Depth m</i>	<i>Unit</i>	<i>Description</i>
	0-0.04 (modern turf at +0.1m)	1	2.5 Y 4/2 Dark greyish brown silt/clay with rare, fine sand-sized mineral grains. Frequent fine roots. Diffuse boundary to:
	0.04-0.32m	2	2.5 Y 4/3 Olive brown silt/clay with rare, fine sand-sized mineral grains and rare angular granules of rock fragments. A compact unit with some granular ped structure. Rare well rounded medium pebble-sized clast of quartzite. Less frequent fine roots. Earthworm bioturbation. Colour associated with minute and dense iron oxide mottling throughout. (Ridge material) Sharp boundary to:
	0.32-0.5	3	5 Y 4/1 Dark grey silt/clay with rare, very fine sand-sized mineral grains. Rare angular granules of flint? Frequent, granular-sized, 5 Y 4/3 Olive brown mottles throughout. Well developed prismatic structure. Frequent very fine root holes. (Probable palaeosol).  Base of Trial Trench: standing water
Auger results	0.5-1.0m	4	10 YR 4/4 Dark yellowish brown silt/clay. 50% mottled (oxidized). Occasional granules of flint, chalk and rock fragments, haematite nodules and black manganese oxide grains. Bioturbated by frequent fine roots. (Till?) Gradual boundary to:
	1.0-1.10	5	10 YR 3/1 Very dark grey, hard, laminated silt/clay with very fine sand lenses (weathered Charmouth Mudstone Formation?)

Table 1. Description of the deposits.

<i>Pollen samples from Monolith 1 taken at</i>	0.01-0.02m
	0.08-0.09m
	0.15-0.16m
	0.22-0.23m
	0.29-0.30m
	0.36-0.37m
	0.43-0.44m
0.49-0.50m	
<i>Micromorphological sample taken at</i>	0.32-0.43m

Table 2. List of samples taken from Monolith 1.

- 4.1 The descriptions of the units in Monolith 1 are listed in stratigraphical order in Table 1 above. The results of augering through the base of the Trial Trench are also listed and should be read with the following proviso in mind: sediment samples derived from the auger chamber are disturbed as a result of the twisting action on augering, therefore, fine sedimentary structures, for example laminations, are often destroyed and the depths of subtle or gradual boundaries are difficult to measure.
- 4.2 The lowermost unit (Unit 5) was believed to represent the weathered top of the Charmouth Mudstone Formation. At approximately 1.0m below ground level it would agree with the elevations recorded in the BGS boreholes further to the east.
- 4.3 Overlying Unit 5 was a yellowish brown silt/clay (Unit 4) showing heavy mottling and grains of black manganese oxide both indicative of a fluctuating water table and oxidizing conditions. These effects are post depositional in origin and affect the top of the mudstone too. Unit 4 was lithologically very similar to Unit 5 except that it contained occasional coarse sand-sized grains and granular-sized rock fragments of flint and chalk and unknown lithology. These clasts were indicative of the mid Pleistocene glacial till. The unit would be expected to be fluviually reworked to a certain extent, however, evidence in the form of fine laminations, for example, were not present.
- 4.4 Overlying Unit 4 was a compact dark grey silt/clay (Unit 3) with a prismatic structure. Microscopic humic material and/or charcoal may account for the dark colour. It was possible that this unit represented a palaeosol developed within the top of the underlying weathered till or alluvium. The unit was heavily mottled as a result of a fluctuating water table and bioturbated by fine roots. There was occasional evidence of iron pan

formation seen at the base of the section but not in the Monolith 1.

- 4.5 A sharp boundary marked the contact between Unit 3 and Unit 2. The overlying deposit (Unit 2) was a compact silt/clay with some granular ped structure and bioturbation by fine roots and earthworms. It was subject to a fluctuating water table that resulted in frequent iron oxide mottles. The unit was interpreted as reworked topsoil that had buried the underlying unit (Unit 3) as ploughing created a ridge.
- 4.6 Unit 1 represented the base of the modern topsoil that had developed in the top of the ridge deposit.
- 4.7 The results of cutting a trench perpendicular to the Clifton Brook were null: there was no evidence of waterlogged deposits, and no evidence for a possible palaeosol. The trench sectioned the headland of the ridge and furrow earthworks on the bank of the brook. The top section of the Charmouth Mudstone Formation was exposed at c.1.4m below ground level as a hard, fossiliferous, purplish blue mudstone overlain by till. A compact, heavily oxidized, dark yellowish brown (10 YR 3/4) silt/clay overlay the till and was distinguished from it only by the relatively fewer clasts of coarse sand-sized grains of rock fragments. The deposit appeared to be a flood plain alluvium in which the modern topsoil had developed (Figure 2).



Figure 2. (left) Trench 10 which sectioned the north bank of the Clifton Brook. Figure 3. (right) Probable alluvial deposits in the west section of Trench 10.

## **5. RESULTS OF THE LABORATORY WORK**

This section will briefly describe the main results of the laboratory work: the micromorphological analysis of Unit 3 (a possible palaeosol) and the pollen assessment. The full report 'DIRFT III Northamptonshire Micromorphology and Pollen Report' by Drs Rowena Banerjea and C.R. Batchelor is attached to this document.

### **5.1 Micromorphology**

5.1.1 The body of the sample – its groundmass – is a clay with rare grains of quartz and flint. It is speckled as a result of the movement of iron and contains chambers and vesicles due to containment of water and biological activity. The structure of the groundmass is sub angular and blocky that is the result of swelling and shrinking of the clay during alternating episodes of wetting and drying. These episodes have also resulted in the post depositional alteration of the groundmass with the formation of iron and manganese nodules.

5.1.2 The features described in the unit are not sufficient to assign it to a class of soils and without independent dating evidence it cannot be said to be early in date (Boreal/Mesolithic). Cereal pollen derived from sample 0.49cm below the micromorphological sample suggests a later date for the palaeosol although movement of younger pollen down the profile could account for its presence.

### **5.2 Pollen assessment**

5.2.1 Eight samples were assessed throughout the monolith and they showed very low concentration and preservation of pollen grains, except for the youngest sample at the top of the sequence. Poor preservation is a consequence of the oxidized and inorganic nature of the sediment.

5.2.2 The pollen assemblage was similar in all the samples. It comprised of grasses, cereals, daisies, thistles, black knapweed, dandelion, plantain, buttercup/water crowsfoot, fat hen and possibly nettle. Pine, oak and honeysuckle – the tree and shrub pollen – were represented by only a few grains. Spores from polypody ferns were present. There was no aquatic pollen recorded. The presence of cereals and their weeds is indicative of cultivation.

5.2.3 The movement of pollen grains through the sediment, enhanced by bioturbation, and the redeposition of the sediment as a result of the ridge and furrow system, curtails the amount of useful information that can be drawn from the assessment. All that can be concluded from the evidence is that the landscape was very open and cultivated, and of the historical period.

## **6. CONCLUSIONS AND RECOMMENDATIONS**

6.1 A palaeosol (Unit 3) was preserved in the top of the alluvium/till, and although it contained some features diagnostic of a Boreal soil, it cannot be dated as such. Cereal pollen present in its base suggests a later date but the grains may have been introduced.

6.2 The palaeosol and the overlying ridge material (Unit 2) were not only inorganic and oxidized but also redeposited sediments that have not preserved pollen well, however, the assessment points to an open and cultivated landscape of historical date.

6.3 No waterlogged organic sediments were found in Trench 10 that sectioned the bank of the Clifton Brook.

6.4 The top of the Charmouth Mudstone Formation bedrock was found to be c.1.4m below ground level in the valley plain in Trench 10.

6.5 It is recommended that no further work be undertaken on the samples because of the poor preservation of the pollen and the lack of an independent dating control.

## **7 ACKNOWLEDGMENTS**

ARCA would like to thank Simon Carlyle, Pete Boyes and Luis Gomens of Cotswold Archaeology; Drs Rowena Banerjea and C.R. Batchelor of Quest; and Dr Eleanor Standley of the University of Oxford for their help with this work.

## **8 BIBLIOGRAPHY**

BGS (2016a) *British Geological Survey lexicon of named rock units*. <http://www.bgs.ac.uk/lexicon/> Accessed 21/10/16.



BGS (2016b) <http://mapapps.bgs.ac.uk/geologyofbritain/home.html>

Accessed 21/10/16

Brown, A.G. (2008) *Alluvial Geoarchaeology: Floodplain Archaeology and Environmental Change*. Cambridge University Press.

Cotswold Archaeology (2016) *DIRFT III Ridge & Furrow Survey Northamptonshire Written Scheme of Investigation for an Archaeological Investigation*. Unpublished report CA Project: 660638

Jones, A.P., Tucker, M.E. and Hart, J.K. (1999) Guidelines and recommendations. In Jones, A.P., Tucker, M.E. and Hart, J.K. (eds) *The description and analysis of Quaternary stratigraphic field sections*. Quaternary Research Association technical guide **7**, London, 27-76.

Munsell Color (2000) *Munsell soil color charts*. Munsell Color, New Windsor (NY).

Tucker, M.E. (2011) *Sedimentary Rocks in the Field: A Practical Guide*. The Geological Field Guide Series. Wiley-Blackwell.

## APPENDIX E: PROJECT RESEARCH AGENDA

(from CgMs 2015)

### ***Anglo-Saxon Northamptonshire Research Agendas (Foard 2006)***

#### Research Agenda 1

*Detailed study of the transition from the Roman agricultural system to the late Saxon open field system, initially facilitated through the digitisation of the existing record of the open field system.*

This phase of the research has included the digitisation of the existing record of the open field system, as far as is practicable, for the parishes of Lilbourne, Yelvertoft and Crick. The comprehensive mapping presented within the Atlas has been geo-referenced within the project GIS database. This has then been supplemented, where relevant, by: HER, HEA and NMP records of medieval activity not recorded in the Atlas; HER, HEA and NMP records of activity pre- and post- dating the medieval period, including Roman; Lidar imagery and analysis; Ordnance Survey mapping; geological mapping; topographic/elevation mapping; and aerial photographic coverage.

The resulting GIS workspace therefore provides a detailed geo-referenced projection of the developing historic landscape within the three parishes, derived from as comprehensive a dataset as is presently available. In this sense, while it has not digitised the available data for the whole of Northamptonshire, the present research has already made a contribution to this aspect of Research Agenda 1. Indeed, it can be seen to provide a thorough and credible model for the useful contextualisation of a programme of commercial archaeological work.

Identification of possible Iron Age to Late Saxon continuity within the settlements excavated during Phases I and II of the development, also makes a certain contribution to this agenda (see Figure 4.4). There is scope for this contribution to be even greater via further investigation within the development site. In particular, Watling Street Roman Road forms an enduring and dominant landscape feature within this area of the county. The road can be seen to have had a profound influence on the arrangement and administration of the landscape from the point of its construction through until present-day.

As a natural point of boundary, Watling Street had a direct influence on the arrangement of almost every *adjacent* township in the county, and formed the western boundary of all three parishes within the study area. It seems likely to have also had a certain degree of influence on the location of numerous Late Saxon/medieval settlements within the north-west of the

county, including Lilbourne and Crick; these appear to have been located equidistant from the road at regular intervals.

It is probable that the Roman road also had a degree of influence on the division of the adjacent agricultural lands. Where they occurred, Roman field boundaries in proximity to the road are likely to have respected its NW-SE oriented course. Those adjacent to the road are, therefore, likely to have been arranged in a regular orthogonal pattern running perpendicular to it, i.e. with a prevailing NE-SW orientation; to an extent, this is likely to have further influenced the arrangement of any adjoining fields at a greater distance from it.

It is clear from the Atlas that the great majority of the western-most medieval furlongs within Lilbourne, Yelvertoft and Crick were also arranged in this way. The known headlands and joints tend to run NE-SW, perpendicular to Watling Street, and this arrangement persists to this day in the prevailing orientation of the current post-enclosure field boundaries. As such, there is a high likelihood that any original Roman field boundaries that might survive buried within the proposed development site are preserved below the NE-SW oriented medieval boundaries (headlands/joints) respecting Watling Street. The testing of this hypothesis through targeted evaluation trenching, and the examination of any stratigraphic relationships revealed, would make a significant contribution to our understanding of the continuity of use of the landscape within this area of Northamptonshire.

The following recommendations are made in respect of Research Agenda 1:

- 1) The project database generated by this phase of the research should be maintained, updated and disseminated to relevant repositories and research groups in its own right, or incorporated into any wider over-arching database(s) aimed at digitising the development of the historic landscape of Northamptonshire. As a minimum, it is recommended that the database, including the geo-referenced Lidar imagery and Atlas mapping, be made available to Northamptonshire HER.
- 2) A programme of targeted evaluation trenching is recommended along the course of mapped headlands and joints within the development site (see Figures 6.2, 6.4 and 6.6 at the end of this report). As discussed, the majority of these conform to the locations of present day field boundaries, especially those NE-SW oriented boundaries to the south of Clifton Brook. These boundaries were not targeted during the previous programme of evaluation trenching (Oxford Archaeology 2011), which focussed on evaluating open

areas. A key target would be the southern boundary of the southern-most furlong in Crick Path Field, Lilbourne (Blocks 34 and 37). As described in Chapter 6, the boundary earthworks associated with this furlong are particularly well preserved. It also forms the historic township boundary, and the present-day parish boundary, with Yelvertoft, enhancing its historic importance and potential.

### Research Agenda 5

*The process of massive arable intensification should be investigated by detailed study of the alluviation of river valleys, specifically with a focus on the potential of palaeochannels to yield pollen data.*

Besides the course of the Clifton Brook and its associated floodplain, a number of palaeochannels are thought to survive within the development site. Key examples are located within Blocks 5, 23 and 20, and 9 and 13. Eight trenches were excavated within Block 5 during previous evaluation (Trenches 42-49; Oxford Archaeology 2011). None of these trenches were specifically targeted along the course of the palaeochannel, however, and none are recorded as having contained any palaeochannel deposits, though Trench 48 did contain patches of grey-blue clay within the natural, which may have derived from riverine conditions.

Ten trenches were excavated in Blocks 23 and 20 (Trenches 82-91). Again, these were not specifically located such as to target the possible palaeochannel, and again they did not reveal any firm evidence for palaeochannel deposits, though the rich clay lias with gravel patches recorded as the natural may have been waterborne in origin. Only a single trench was dug in proximity to the possible palaeochannel in Block 13 (Trench 64). This trench did contain alluvial deposits to the west. While these deposits may have derived from a former palaeochannel, they may as well represent the wider alluvial plain recorded in this area.

While the above *initial* review of the information collected from these trenches suggests that there is only limited potential for any contribution to this research agenda, a more detailed review of the results might reveal otherwise. More realistically, the information obtained during the previous evaluation might help to inform further targeted trenching aimed at sampling palaeochannel deposits.

The following recommendations are made in respect of Research Agenda 5:

- 1) The results of the previous evaluation should be reviewed for any potential to help establish the location of the possible palaeochannels.
- 2) Consideration should be given to targeting a small number of additional trenches specifically along the course of the possible palaeochannels within the development site, as well as along the Clifton Brook floodplain. The aim of these trenches should be to enable samples to be taken for palaeoenvironmental analysis, particularly pollen analysis.

### Research Agenda 7

*Can the study of manuring patterns enhance the understanding of the intensity of exploitation between the 10th and the 13th century?*

Analysis of the distribution of dateable pottery forms (10th-13th century) might contribute to this agenda; away from known settlements, these are likely to have been mixed in with manure. Ordinarily, this might be achieved through a programme of field-walking of freshly-ploughed arable land. In this instance, however, the majority of the land within the development site is pasture and would not be conducive to such a methodology. The main exception to this is in the south-east of the site, within Crick parish, which has a higher frequency of arable fields.

While a conventional programme of field-walking might be undertaken on any arable land, a different approach would be required for the rest of the site. This would require a non-traditional archaeological approach, specifically the hand-digging of sections through suitable ridges, headlands and other positive earthworks, in spits, with pottery samples obtained from the various horizons.

This might be supplemented by the implementation of a programme of episodic field-walking and finds collection, following topsoil stripping and other monitored groundworks associated with the development. This information might then be reviewed, along with any finds collected during the afore-mentioned investigations, during trenching in respect of any other research agendas, and during the conventional field-walking of any arable areas. Providing suitable quantities of 10th-13th century pottery were recovered, the distribution of this pottery, both stratigraphically and spatially, could then be mapped and analysed.

The following recommendations are made in respect of Research Agenda 7:

- 1) Consideration should be given to a programme of archaeological field-walking targeted on those fields (within the development site) that are in current arable use.
- 2) Targeted hand-dug trenches should be excavated through a selection of suitable ridges, headlands and other positive earthworks, in spits, and pottery samples obtained from the various horizons.
- 3) Monitoring of groundworks associated with the development (e.g. watching brief) should include, where practicable, the field-walking/close examination of excavations, stripped surfaces etc., and the recovery of any identifiable archaeological material.
- 4) Topsoil and subsoil deposits should be examined, as far as is practicable, during any further evaluation trenching, trial pitting etc. undertaken, and any archaeological finds recovered.
- 5) Following the completion of DIRFT III, the distribution of any 10th-13th century material collected in respect of Recommendations 1-4 above should be mapped, both stratigraphically and spatially, and analysed.

#### Research Agenda 8

*What role did chronologically earlier features serve in the basic framework of the open field system?*

This research agenda would be addressed by Recommendation 2 for Research Agenda 1 (see above).

#### ***Medieval Research Agendas (Lewis 2006, and Foard 2006)***

##### Research Agenda 10

*Provide a more detailed chronology of the establishment of the open field system, as well as improve the understanding of the reasons for, and mechanisms behind, such a comprehensive reorganisation. More detailed archaeological evidence is needed to refine dating of the origins of the regular midland open field system in the region which has the best-surviving evidence in England.*

Establishing a chronology for the development of the open field system, will require a combination of focussed morphological analysis of the surviving earthworks, evaluation and analysis of any surviving stratigraphy, i.e. key relationships between field system elements, and the recovery of *in situ* dateable material, such as pottery, coins etc. from these remains. The GIS database compiled during the present assessment should allow for the morphological analysis, though any such analysis would be *prima facie* and localised within the development site. This would then inform the stratigraphic analysis, which would require targeted evaluation. Key targets would be those Blocks identified in Chapter 6 (and highlighted in Appendix E) of this assessment as having a high level of survival, diversity and potential, as these are the areas where potentially valuable stratigraphic relationships are likely to be best preserved. The agricultural nature of medieval open fields means that *in situ* dateable material is likely to be scarce. However, the best chance of recovering any is via evaluation of the key features described above.

The following recommendations are made in respect of Research Agenda 10:

- 1) Focused morphological analysis should be undertaken to try and establish a framework chronology for the development of the earthworks in key areas of survival. Specifically this should be focussed on Blocks 5, 16-21, 23-29, 32, 34-35, and 37-38. This analysis should focus on the stratigraphic relationships revealed in/inferable from the Lidar imagery. It should also utilise available aerial photography and the results of the previous geophysical survey (Northamptonshire Archaeology 2011) and evaluation trenching (Oxford Archaeology 2011) as necessary. Targeted field survey might also be considered, where practicable.
- 2) The framework chronology described in Recommendation 1) should then be tested by means of a programme of targeted trenching focussed on investigating any key stratigraphic relationships identified. Some of these trenches might be combined with those recommended in respect of Research Agenda 1, which would specifically target key boundary features (headlands/joints etc.). The wider scope of this agenda, however, dictates that a broader range of features be targeted, key targets being: a) relict headlands, such as in Blocks 27 (Figure 6.8c) and 34 (Figure 6.8e); b) relict joints, such as in Block 43, which forms one of the few surviving traces of a long furlong boundary; c) the sequence of re-orientation of lands in the north of Block 34 (Figure 6.8h); and d) variable ridge profiles, such as within Blocks 18, 20, 21, 25. The undefined earthworks in Block 21 (Figure 6.10a) and the

location of Shenley DMV as posited by RCHME (Figure 6.7b) should also be tested. Any other targets would rely on the findings of Recommendation 1.

- 3) No evaluation trenching, or other intrusive investigations, should take place within Blocks 46 and 47 in the north of the development site, as these are to be preserved as part of the development.

### Research Agenda 11

*Recovery of environmental evidence from open field systems is needed to help ascertain the impact of the introduction of the open field system and associated changes in land use. Such evidence would also throw new light on the introduction of new crop species such as rivet wheat and new combinations of cropping such as dredge, and their impact on field use.*

It is the areas of present-day and historical water-logging – including flood plains, palaeochannels and other alluvial contexts – that are most likely to contain preserved palaeoenvironmental evidence, such as seeds, grains and pollens. To a larger extent, therefore, the requirements of contributing to this research agenda are similar to those set out previously in respect of Research Agenda 2, examining flood plain meadow, and Research Agenda 5, examining palaeochannel potential. As described, such deposits are best recovered via targeted trenching of known/suspected alluvial deposits as well as any other waterlogged contexts.

The following recommendations are made in respect of Research Agenda 11:

- 1) The environmental information contained within the project GIS database, the records taken during the previous programme of evaluation trenching, and any borehole records (e.g. maintained by BGS), should be reviewed. This review should aim to identify areas of anticipated palaeo-environmental preservation, as well as to rule out areas where such preservation is unlikely.
- 2) The results of Recommendation 1) should be used to inform a programme of targeted field assessment involving a combination of borehole sampling, trial pitting and evaluation trenching, aimed at locating and retrieving viable environmental samples.
- 3) The results of the sampling described in Recommendation 2) should be mapped and analysed in the context of stratigraphic and other information gathered during the course of the assessment.



### Research Agenda 15

*A combined approach utilising documentary and archaeological research into field system origins, organisation and intensification, focused upon those field systems which are best preserved and best documented.*

This research agenda largely equates to Research Agenda 12. The iterative programme of DIRFT III investigations will make a contribution to this research agenda, and no further specific recommendations are made.

**APPENDIX F: OASIS REPORT FORM**

<b>PROJECT DETAILS</b>		
Project name	DIRFT III Ridge & Furrow Survey, Northamptonshire	
Short description	On the floodplain, a buried soil horizon was encountered beneath the mineralised medieval ploughsoil. This deposit had some of the characteristics of a Boreal soil (i.e. Mesolithic/Neolithic), but pollen analysis suggests that it was probably a cultivated soil. The soil horizon overlay a variety of vegetation features (tree throw hollows etc.), suggesting that the floodplain supported some degree of tree cover prior to clearance for agricultural use. There was no suitable organic material for radiocarbon dating, so the age of the buried soil is uncertain. However, small ditches were also identified beneath the buried soil, probably forming part of an agricultural ditch system of Late Iron Age or Roman date. It is therefore probable that the buried soil horizon dates to the first millennium AD. Investigation of the medieval ridge and furrow earthworks identified some changes to its organisation during its period of active use, but dating these changes was constrained by the lack of dateable artefactual material and the homogeneity of the subsoil that formed the earthwork features.	
Project dates	14th March 2016 – 6th April 2016	
Project type	Field evaluation	
Previous work	Heritage Assessment (CgMs 2012) Ridge and Furrow Assessment (CA 2015) SMS excavation (CA forthcoming)	
Future work	Unknown	
Monument type	Medieval ridge and furrow	
Significant finds	None	
<b>PROJECT LOCATION</b>		
Site location	DIRFT III, Crick, Northamptonshire	
Study area	340ha	
Site co-ordinates	SP 5648 7540	
<b>PROJECT CREATORS</b>		
Name of organisation	Cotswold Archaeology (CA)	
Project Brief originator	-	
Project Design (WSI) originator	CA	
Project Manager	Simon Carlyle (CA); Sally Dicks (CgMs)	
Project Supervisor	Peter Boyer (CA)	
<b>PROJECT ARCHIVE</b>		
	Accession no: n/a	Content
Physical	NARC	Pottery
Paper		Site records
Digital	Northamptonshire HER	Report, digital photos
<b>BIBLIOGRAPHY</b>		
CA (Cotswold Archaeology) 2016 <i>DIRFT III Ridge and Furrow Survey, Northamptonshire: Geoarchaeological and Archaeological Investigation</i> . CA typescript report <b>16183</b>		

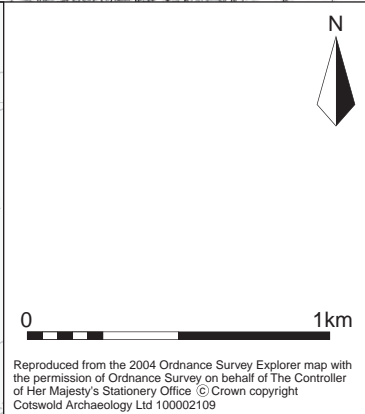
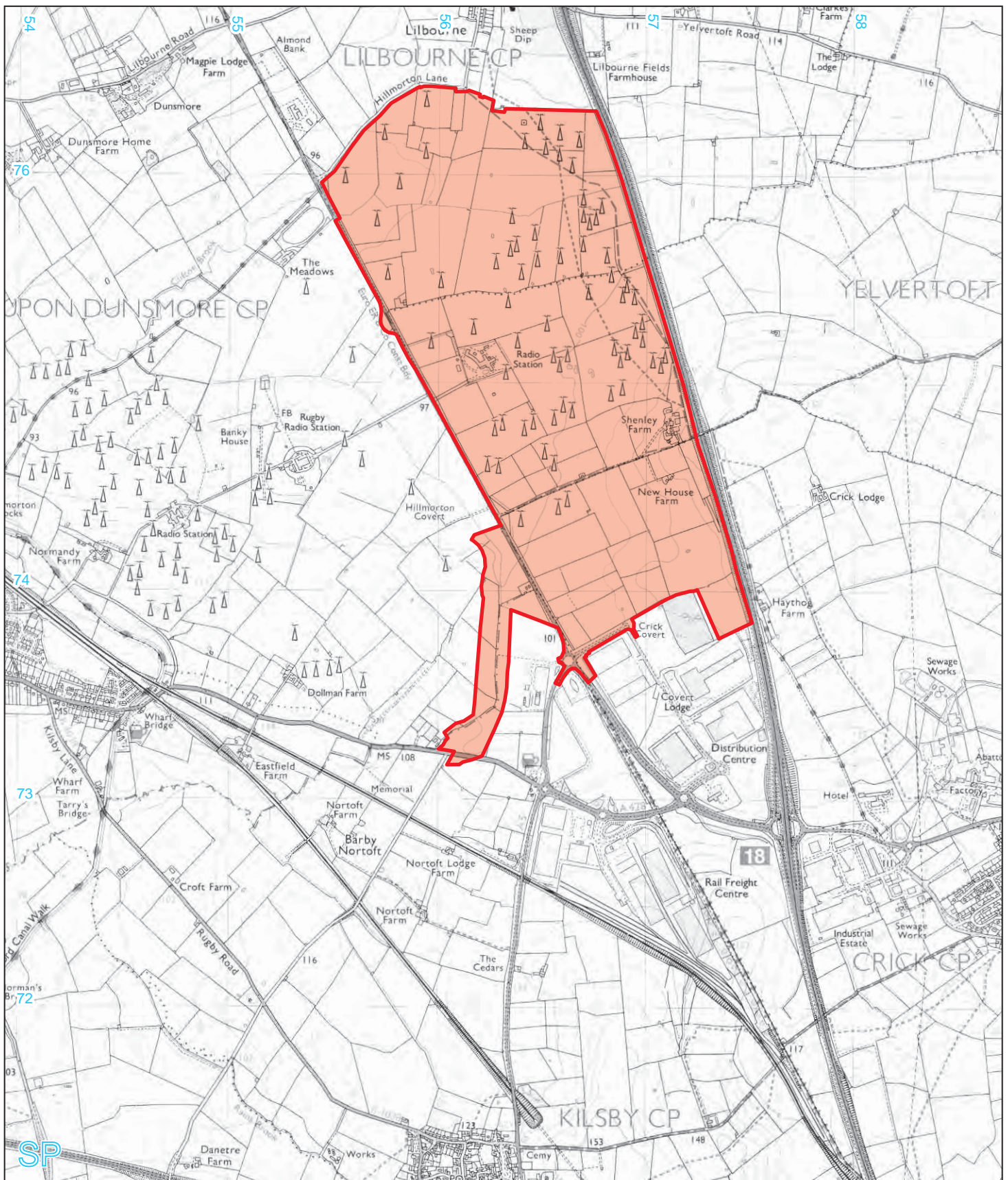



Andover 01264 347630  
 Cirencester 01285 771022  
 Exeter 01392 826185  
 Milton Keynes 01908 564660  
[www.cotswoldarchaeology.co.uk](http://www.cotswoldarchaeology.co.uk)  
[enquiries@cotswoldarchaeology.co.uk](mailto:enquiries@cotswoldarchaeology.co.uk)

---

**PROJECT TITLE**  
 DIRFT III Ridge and Furrow Investigation  
 Northamptonshire

---

**FIGURE TITLE**  
 Site location plan

---

DRAWN BY	AO	PROJECT NO.	660638	<b>FIGURE NO.</b>
CHECKED BY	LM	DATE	19/04/2016	
APPROVED BY	SCC	SCALE @A4	1:25,000	<b>1</b>

Reproduced from the 2004 Ordnance Survey Explorer map with the permission of Ordnance Survey on behalf of The Controller of Her Majesty's Stationery Office © Crown copyright Cotswold Archaeology Ltd 100002109

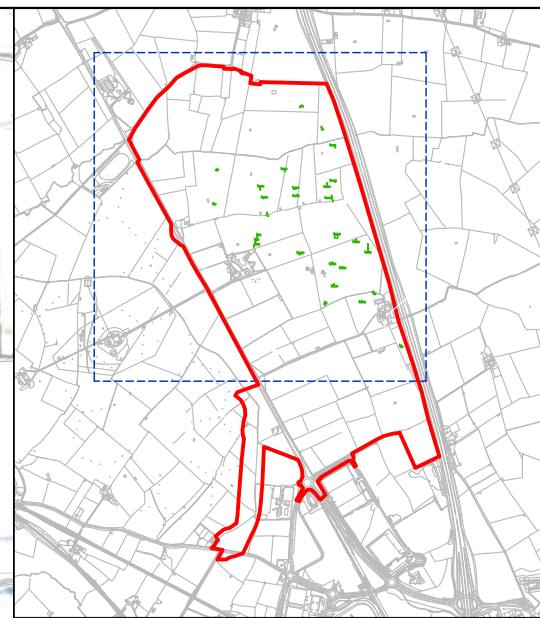
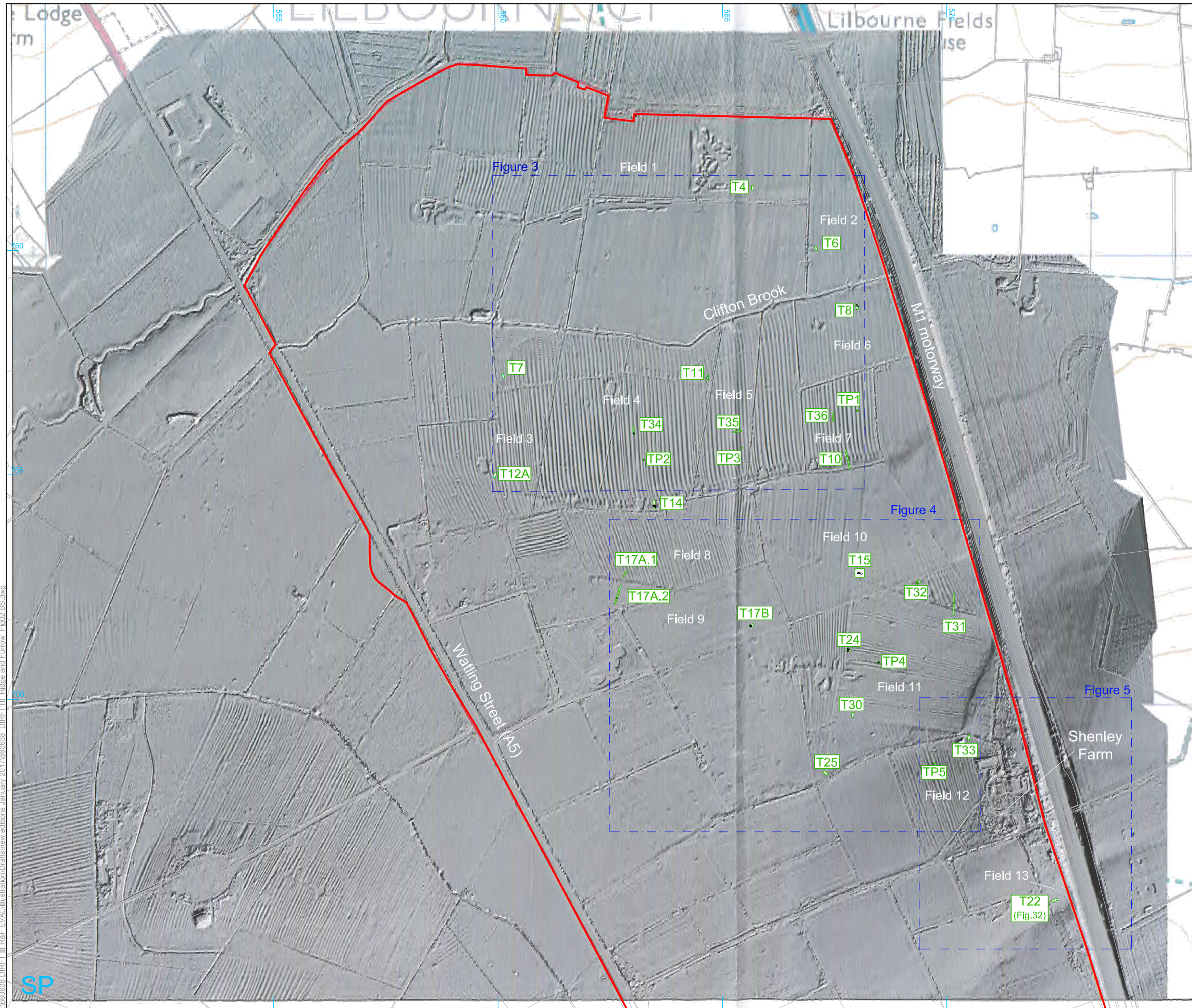

- ▭ site boundary
- ▭ evaluation trench/test pit
- ▭ archaeological feature
- ▭ geological feature
- ▭ furrow
- ▭ modern
- ▭ field drain
- ▭ treethrow

 Andover 01264 347630  
 Cirencester 01285 771022  
 Exeter 01392 826185  
 Milton Keynes 01908 564660  
[www.cotswoldarchaeology.co.uk](http://www.cotswoldarchaeology.co.uk)  
[enquiries@cotswoldarchaeology.co.uk](mailto:enquiries@cotswoldarchaeology.co.uk)

PROJECT TITLE  
**DIRFT III Ridge and Furrow Investigation Northamptonshire**

FIGURE TITLE  
**Trench location plan, showing archaeological features and LIDAR survey**

DRAWN BY	AO	PROJECT NO.	660638	FIGURE NO.
CHECKED BY	LM	DATE	17/01/2017	<b>2</b>
APPROVED BY	SCC	SCALE@A3	1:8000	

P:\660638 DIRFT III R&F EVAL\Illustration\Drafts\new editions January 2017\660638 DIRFT III Ridge and Furrow Fig02 BS.dwg



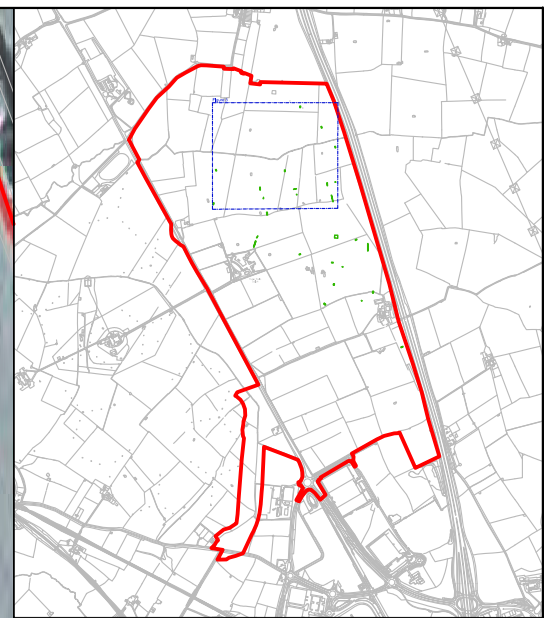

- site boundary
- evaluation trench/test pit
- archaeological feature
- furrow
- field drain
- treethrow



Reproduced from the Ordnance Survey digital mapping with the permission of Ordnance Survey on behalf of The Controller of Her Majesty's Stationary Office © Crown copyright Cotswold Archaeology Ltd 100002109.

**Andover** 01264 347630  
**Cirencester** 01285 771022  
**Exeter** 01392 826185  
**Milton Keynes** 01908 564660  
[www.cotswoldarchaeology.co.uk](http://www.cotswoldarchaeology.co.uk)  
[enquiries@cotswoldarchaeology.co.uk](mailto:enquiries@cotswoldarchaeology.co.uk)

**PROJECT TITLE**  
 DIRFT III Ridge and Furrow Investigation Northamptonshire

**FIGURE TITLE**  
 Detailed trench location plan (north), showing archaeological features and LIDAR survey

DRAWN BY	AO	PROJECT NO.	660638	FIGURE NO.
CHECKED BY	LM	DATE	17/01/2017	<b>3</b>
APPROVED BY	SCC	SCALE@A3	1:2500	

P:\660638 DIRFT III R&F EVAL\Illustration\Drafts\new editions January 2017\660638 DIRFT III Ridge and Furrow Fig02 BS.dwg

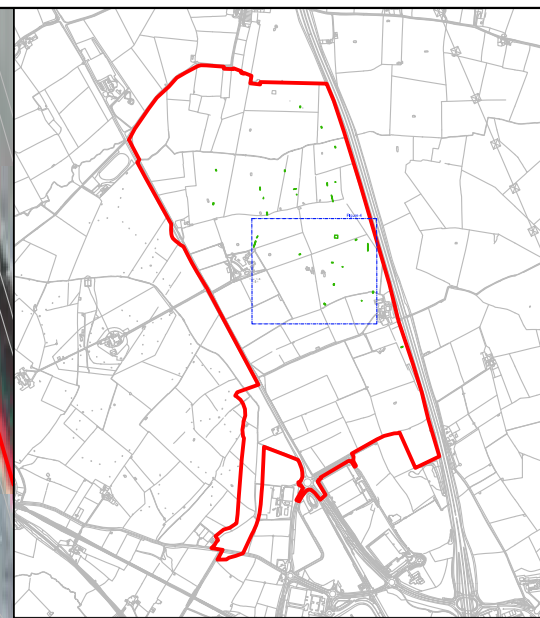
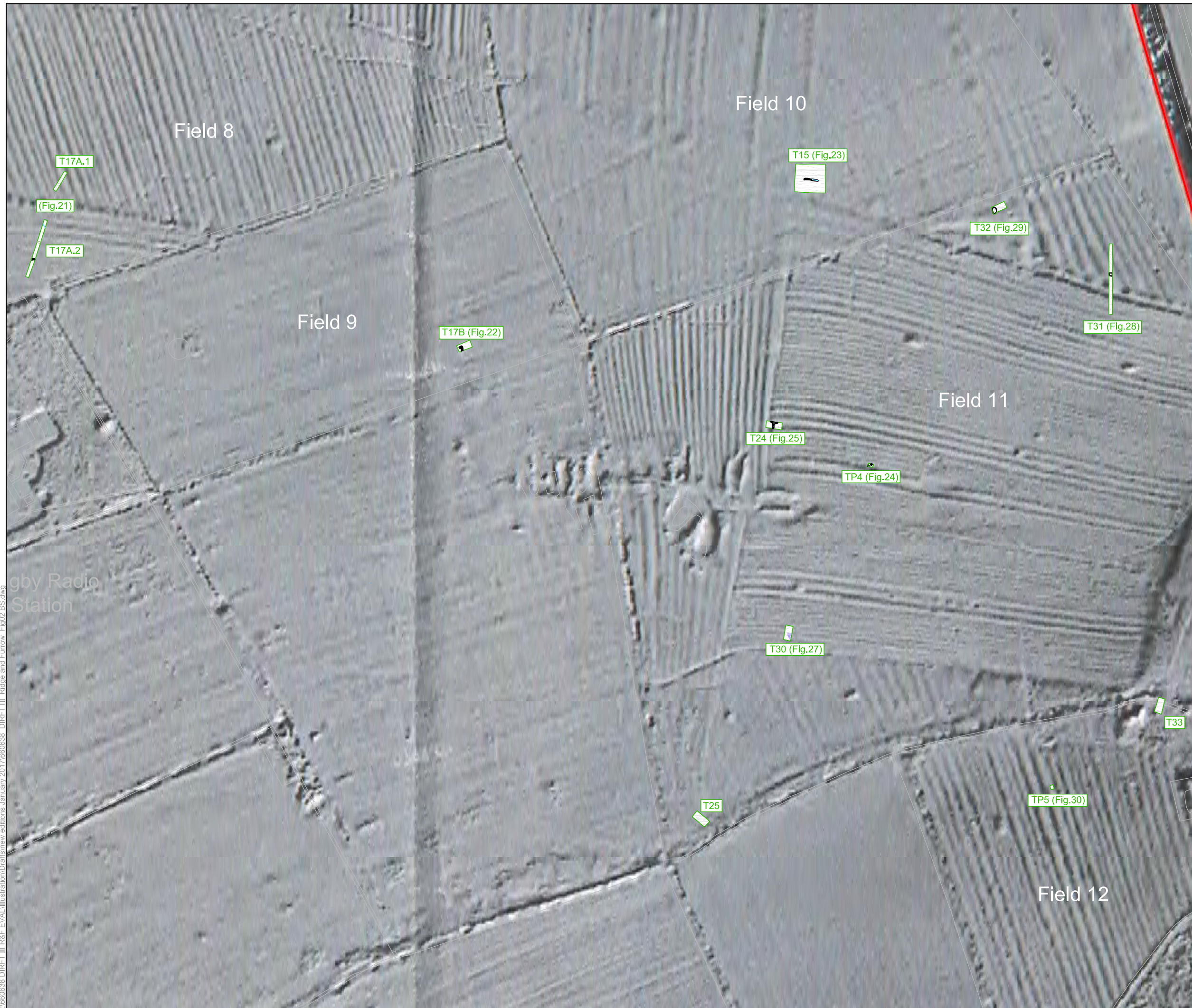

- ▭ site boundary
- ▭ evaluation trench/test pit
- ▭ archaeological feature
- ▭ geological feature
- ▭ field drain



Reproduced from the Ordnance Survey digital mapping with the permission of Ordnance Survey on behalf of The Controller of Her Majesty's Stationery Office © Crown copyright Cotswold Archaeology Ltd 100002109.



  
**Andover** 01264 347630  
**Cirencester** 01285 771022  
**Exeter** 01392 826185  
**Milton Keynes** 01908 564660  
[www.cotswoldarchaeology.co.uk](http://www.cotswoldarchaeology.co.uk)  
[enquiries@cotswoldarchaeology.co.uk](mailto:enquiries@cotswoldarchaeology.co.uk)

**PROJECT TITLE**  
 DIRFT III Ridge and Furrow Investigation  
 Northamptonshire

**FIGURE TITLE**  
 Detailed trench location plan (centre),  
 showing archaeological features and  
 LIDAR Survey

DRAWN BY	AO	PROJECT NO.	660638	FIGURE NO.
CHECKED BY	LM	DATE	17/01/2017	<b>4</b>
APPROVED BY	SCC	SCALE@A3	1:2500	

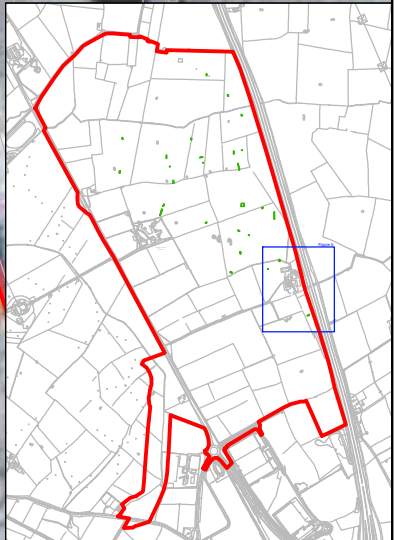
P:\660638 DIRFT III R&F EVAL\Illustration\Drafts\new editions January 2017\660638 DIRFT III Ridge and Furrow Fig02 BS.dwg



- site boundary
- evaluation trench/test pit



Andover 01264 347630  
 Cirencester 01285 771022  
 Exeter 01392 826185  
 Milton Keynes 01908 564660  
 w [www.cotswoldarchaeology.co.uk](http://www.cotswoldarchaeology.co.uk)  
 e [enquiries@cotswoldarchaeology.co.uk](mailto:enquiries@cotswoldarchaeology.co.uk)

**PROJECT TITLE**  
 DIRFT III Ridge and Furrow Investigation  
 Northamptonshire

**FIGURE TITLE**  
 Detailed trench location plan (south),  
 showing archaeological features and  
 LIDAR Survey



DRAWN BY	AO	PROJECT NO.	660638	FIGURE NO.
CHECKED BY	LM	DATE	17/01/2017	<b>5</b>
APPROVED BY	SCC	SCALE@A3	1:2500	

P:\660638 DIRFT III R&F EVAL\Illustration\Drawings\new editions January 2017\660638 DIRFT III Ridge and Furrow Fig02 BS.dwg



6

**6** General view of the site from Shenley Farm, looking north-west



Andover 01264 347630  
 Cirencester 01285 771022  
 Exeter 01392 826185  
 Milton Keynes 01908 564660  
[www.cotswoldarchaeology.co.uk](http://www.cotswoldarchaeology.co.uk)  
[enquiries@cotswoldarchaeology.co.uk](mailto:enquiries@cotswoldarchaeology.co.uk)

PROJECT TITLE

**DIRFT III Ridge and Furrow Investigation  
 Northamptonshire**

FIGURE TITLE

**Photographs**

DRAWN BY	AO	PROJECT NO.	660638	FIGURE NO.
CHECKED BY	LM	DATE	17/01/2017	
APPROVED BY	SCC	SCALE@A4	N/A	<b>6</b>





7



8

7 Trench 4, looking north (2m scale)

8 Trench 6, looking north-west (2m scale)



Andover 01264 347630  
 Cirencester 01285 771022  
 Exeter 01392 826185  
 Milton Keynes 01908 564660  
[www.cotswoldarchaeology.co.uk](http://www.cotswoldarchaeology.co.uk)  
[enquiries@cotswoldarchaeology.co.uk](mailto:enquiries@cotswoldarchaeology.co.uk)

PROJECT TITLE

DIRFT III Ridge and Furrow Investigation  
 Northamptonshire

FIGURE TITLE

Photographs

DRAWN BY	AO	PROJECT NO.	660638	FIGURE NO.
CHECKED BY	LM	DATE	17/01/2017	7 & 8
APPROVED BY	SCC	SCALE@A4	N/A	



9

9 Trench 7, looking south (2m scale)



Andover 01264 347630  
 Cirencester 01285 771022  
 Exeter 01392 826185  
 Milton Keynes 01908 564660  
[www.cotswoldarchaeology.co.uk](http://www.cotswoldarchaeology.co.uk)  
[enquiries@cotswoldarchaeology.co.uk](mailto:enquiries@cotswoldarchaeology.co.uk)

PROJECT TITLE

DIRFT III Ridge and Furrow Investigation  
 Northamptonshire

FIGURE TITLE

Photograph

DRAWN BY AO PROJECT NO. 660638  
 CHECKED BY LM DATE 17/01/2017  
 APPROVED BY SCC SCALE@A4 N/A

FIGURE NO.

9



10

10 Trench 12a, looking south (2m scale)



Andover 01264 347630  
 Cirencester 01285 771022  
 Exeter 01392 826185  
 Milton Keynes 01908 564660  
[www.cotswoldarchaeology.co.uk](http://www.cotswoldarchaeology.co.uk)  
[enquiries@cotswoldarchaeology.co.uk](mailto:enquiries@cotswoldarchaeology.co.uk)

PROJECT TITLE

DIRFT III Ridge and Furrow Investigation  
 Northamptonshire

FIGURE TITLE

Photograph

DRAWN BY	AO	PROJECT NO.	660638	FIGURE NO.
CHECKED BY	LM	DATE	17/01/2017	10
APPROVED BY	SCC	SCALE@A4	N/A	

Section BB

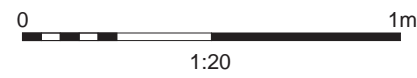
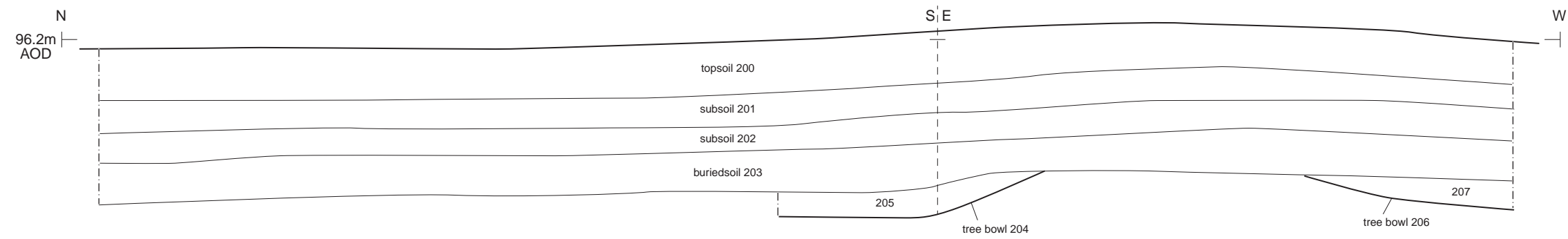

 Tree bowl

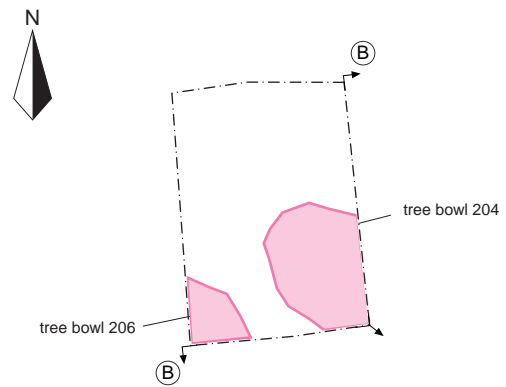

Test Pit 2, looking south (2m scale)

 Cotswold Archaeology  
 Andover 01264 347630  
 Cirencester 01285 771022  
 Exeter 01392 826185  
 Milton Keynes 01908 564660  
 www.cotswoldarchaeology.co.uk  
 enquiries@cotswoldarchaeology.co.uk

PROJECT TITLE  
 DIRFT III Ridge and Furrow Investigation  
 Northamptonshire

FIGURE TITLE  
**Test Pit 2: plan, section and photograph**

DRAWN BY	AO	PROJECT NO.	660638	FIGURE NO.
CHECKED BY	LM	DATE	17/01/2017	11
APPROVED BY	SCC	SCALE@A3	1:20 & 1:100	

Section II

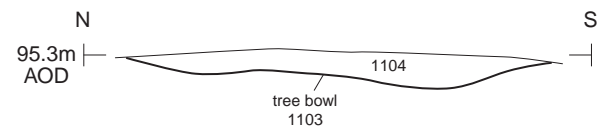

Section JJ

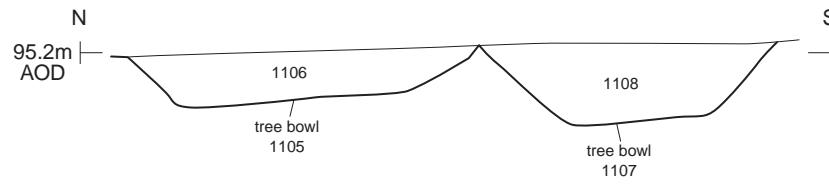

Section KK

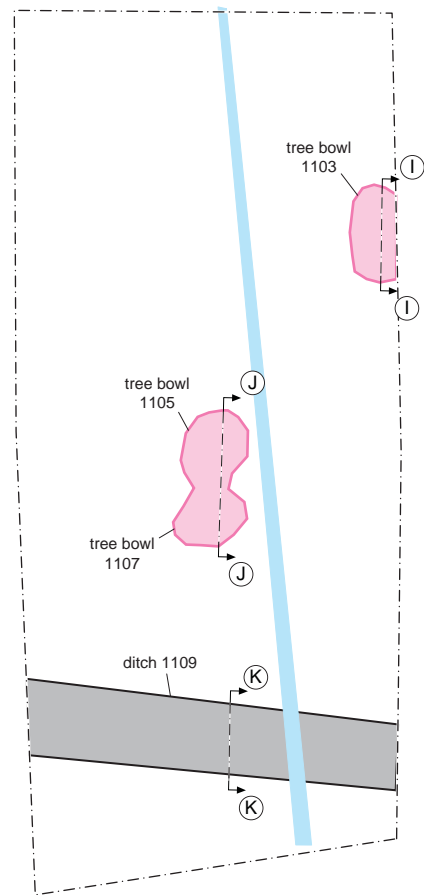
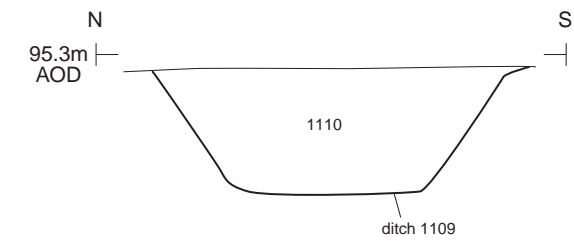

Trench 11, looking north (2m scale)

- Archaeological feature
- Tree bowl
- Field drain

Cotswold Archaeology  
 Andover 01264 347630  
 Cirencester 01285 771022  
 Exeter 01392 826185  
 Milton Keynes 01908 564660  
 www.cotswoldarchaeology.co.uk  
 enquiries@cotswoldarchaeology.co.uk

PROJECT TITLE  
 DIRFT III Ridge and Furrow Investigation  
 Northamptonshire

FIGURE TITLE  
**Trench 11: plan, sections and photograph**

DRAWN BY	AO	PROJECT NO.	660638	FIGURE NO.
CHECKED BY	LM	DATE	17/01/2017	12
APPROVED BY	SCC	SCALE@A3	1:125 & 1:500	

Section LL

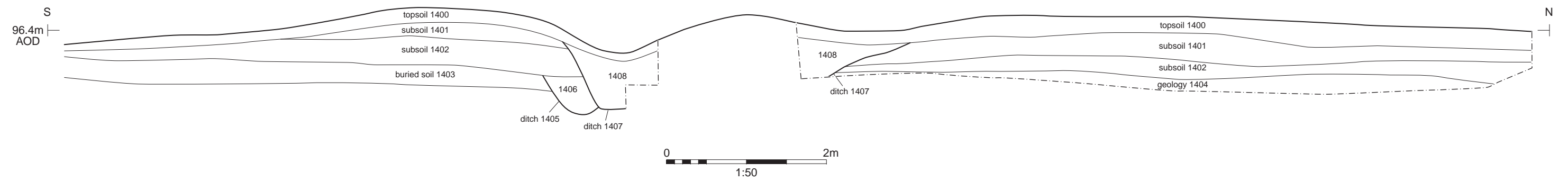

Section MM

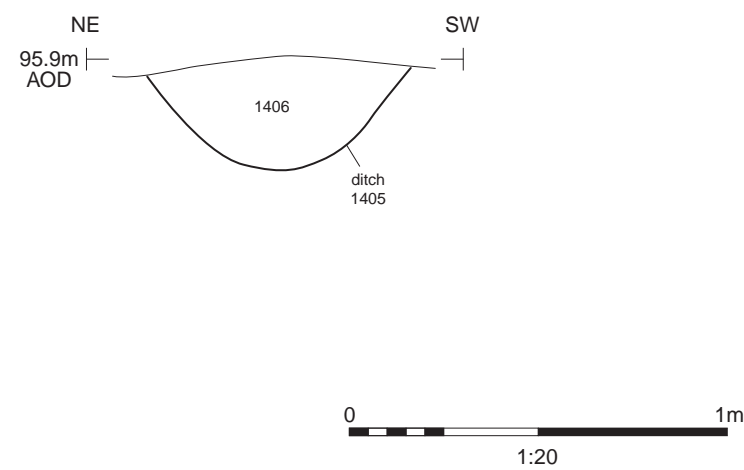

Section NN

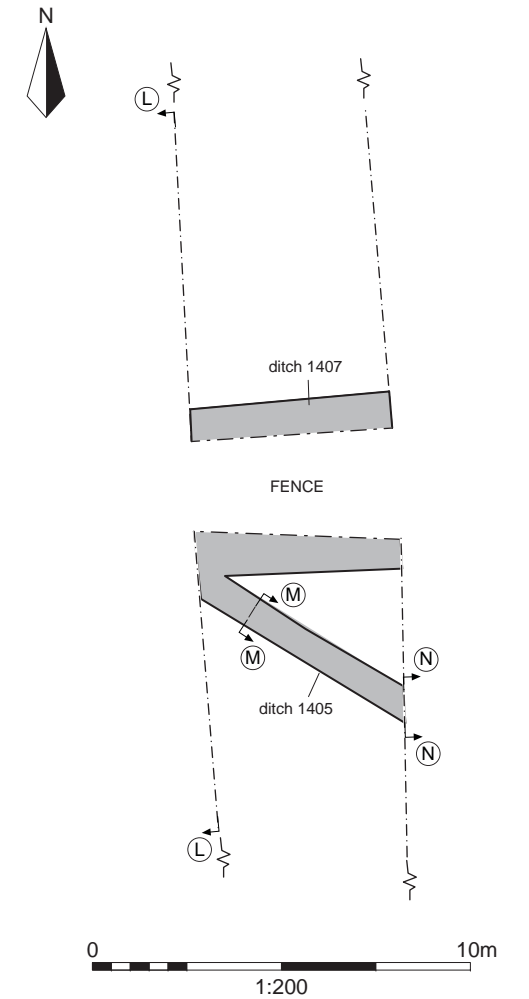
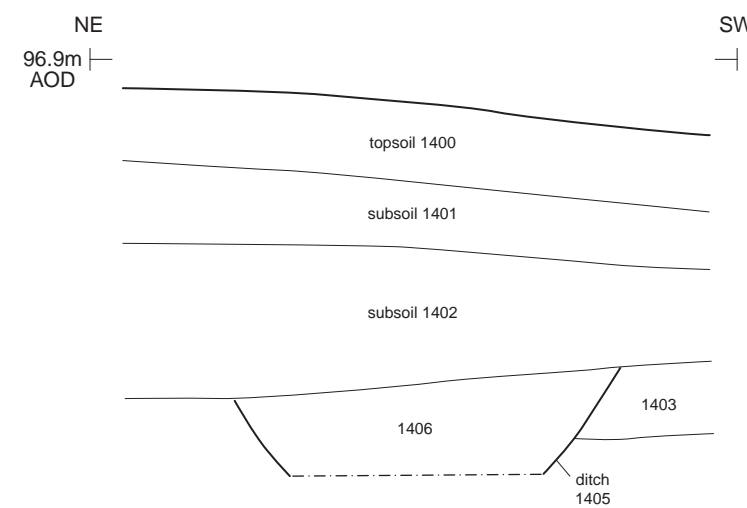

Ditch 1405, looking south-east (0.5m scale)



Trench 14 (south), looking north (2m scale)



**Cotswold Archaeology**  
 Andover 01264 347630  
 Cirencester 01285 771022  
 Exeter 01392 826185  
 Milton Keynes 01908 564660  
 www.cotswoldarchaeology.co.uk  
 enquiries@cotswoldarchaeology.co.uk

PROJECT TITLE  
**DIRFT III Ridge and Furrow Investigation**  
 Northamptonshire

FIGURE TITLE  
**Trench 14: plan, sections and**  
**photographs**

DRAWN BY **AO** PROJECT NO. **660638** FIGURE NO.  
 CHECKED BY **LM** DATE **17/01/2017**  
 APPROVED BY **SCC** SCALE@A3 **1:125 & 1:500** **13**

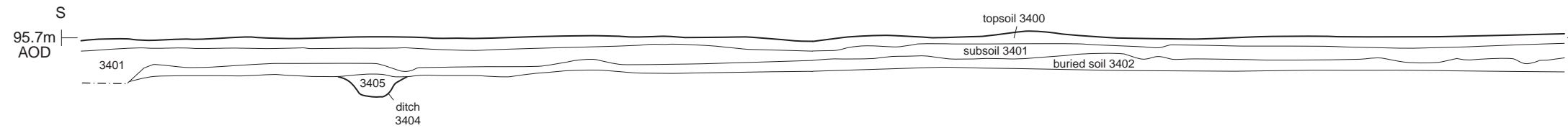
Section XX



Section YY

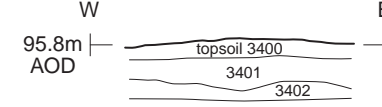

Section ZZ

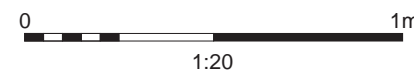
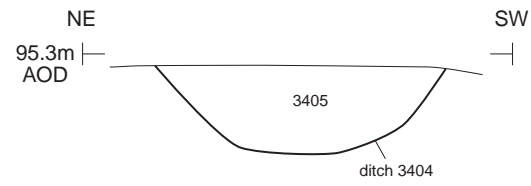

Ditch 3404, looking west (0.5m scale)

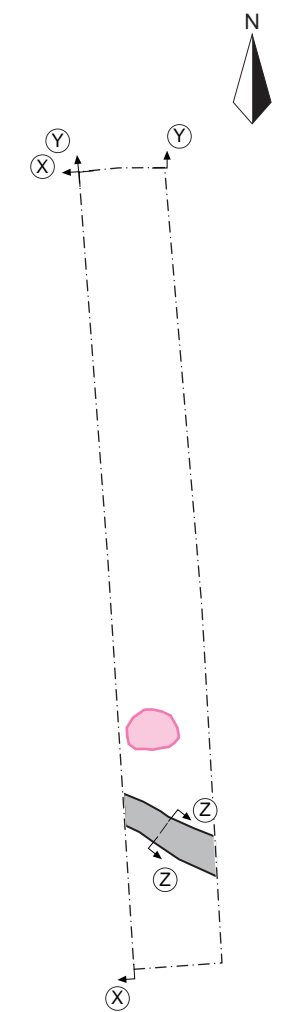

- Archaeological feature
- Tree-throw



Hoeing buried soil in Trench 34



Trench 34, looking north (2m scale)

**Cotswold Archaeology**  
 Andover 01264 347630  
 Cirencester 01285 771022  
 Exeter 01392 826185  
 Milton Keynes 01908 564660  
 www.cotswoldarchaeology.co.uk  
 enquiries@cotswoldarchaeology.co.uk

PROJECT TITLE  
**DIRFT III Ridge and Furrow Investigation Northamptonshire**

FIGURE TITLE  
**Trench 34: plan, sections and photographs**

Section CC

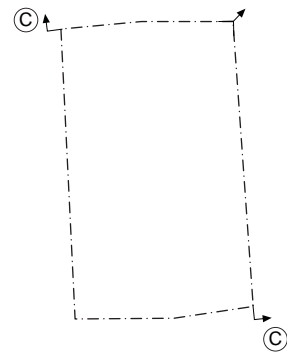
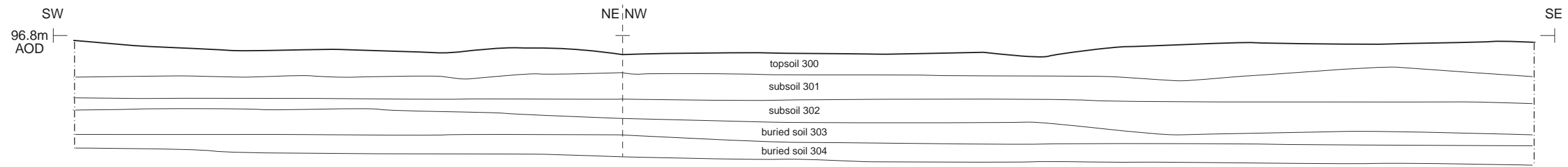

Test Pit 3, looking south (2m scale)

**Cotswold Archaeology**  
 Andover 01264 347630  
 Cirencester 01285 771022  
 Exeter 01392 826185  
 Milton Keynes 01908 564660  
 www.cotswoldarchaeology.co.uk  
 enquiries@cotswoldarchaeology.co.uk

PROJECT TITLE  
**DIRFT III Ridge and Furrow Investigation**  
 Northamptonshire

FIGURE TITLE  
**Test Pit 3: plan, section and photograph**

DRAWN BY	AO	PROJECT NO.	660638	FIGURE NO.
CHECKED BY	LM	DATE	17/01/2017	15
APPROVED BY	SCC	SCALE@A3	1:20 & 1:100	



Section aa

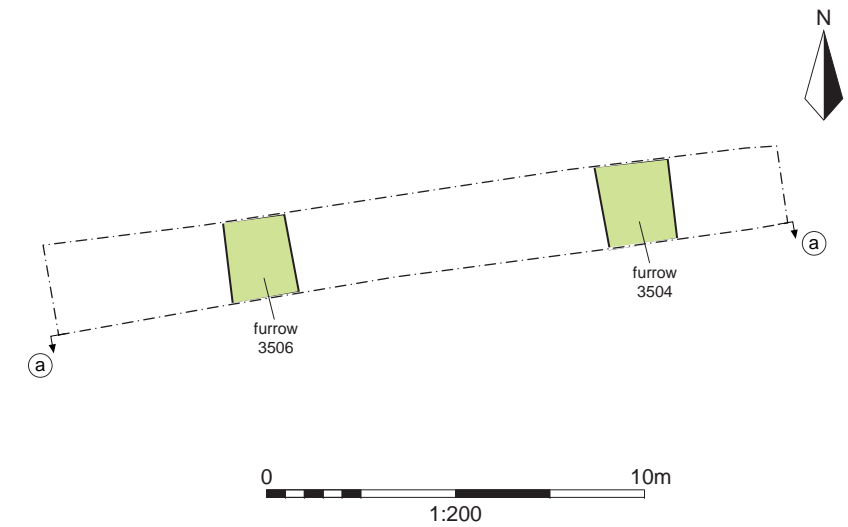
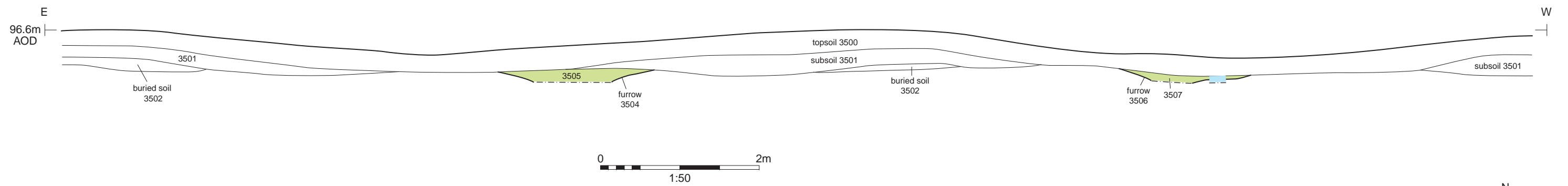

Trench 35, looking west (2m scale)

- Furrow
- Field drain

**Cotswold Archaeology**  
 Andover 01264 347630  
 Cirencester 01285 771022  
 Exeter 01392 826185  
 Milton Keynes 01908 564660  
 www.cotswoldarchaeology.co.uk  
 enquiries@cotswoldarchaeology.co.uk

PROJECT TITLE  
**DIRFT III Ridge and Furrow Investigation  
 Northamptonshire**

FIGURE TITLE  
**Trench 35: plan, sections and  
 photographs**

DRAWN BY	AO	PROJECT NO.	660638	FIGURE NO.
CHECKED BY	LM	DATE	17/01/2017	<b>16</b>
APPROVED BY	SCC	SCALE@A3	1:50 & 1:200	

Section GG

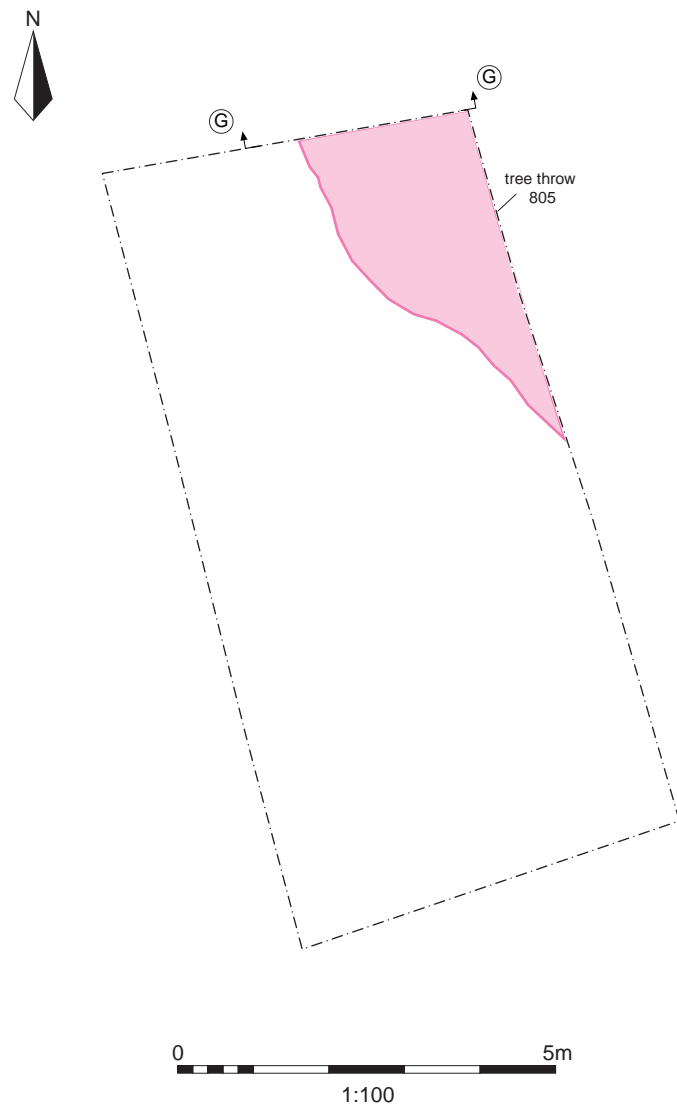
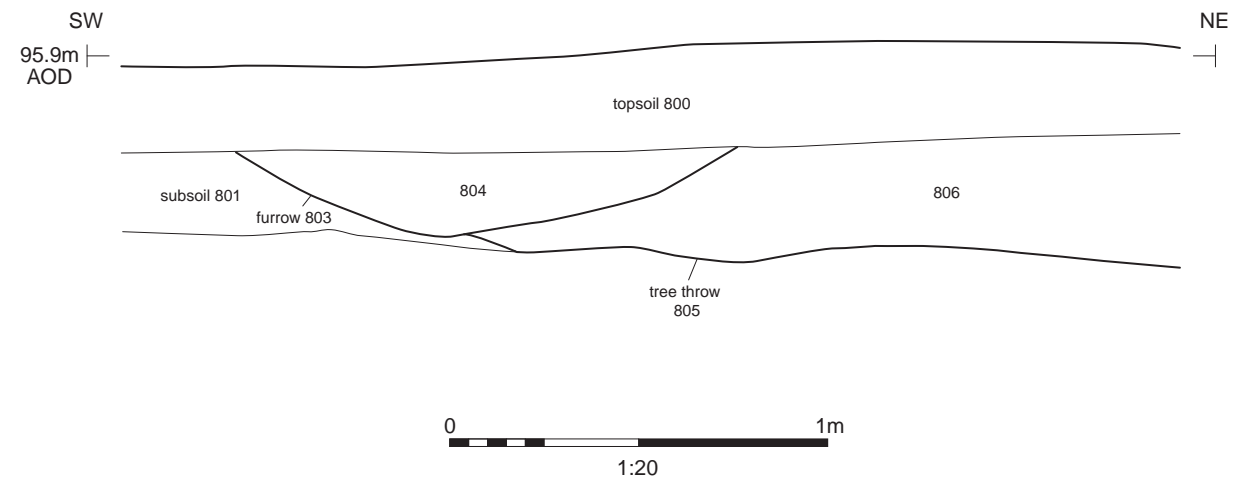

 Tree throw

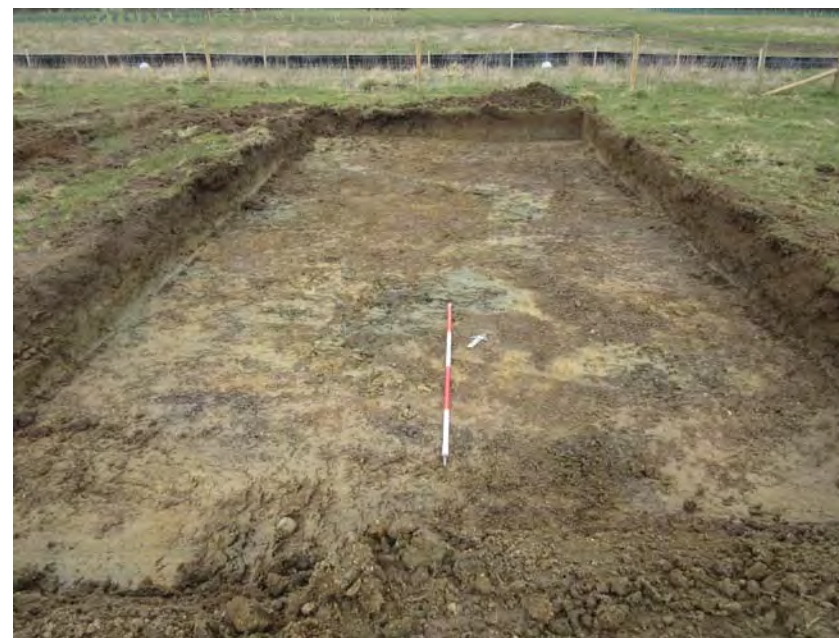

Trench 8, looking north-west (2m scale)

 Cotswold Archaeology  
 Andover 01264 347630  
 Cirencester 01285 771022  
 Exeter 01392 826185  
 Milton Keynes 01908 564660  
 www.cotswoldarchaeology.co.uk  
 enquiries@cotswoldarchaeology.co.uk

PROJECT TITLE  
 DIRFT III Ridge and Furrow Investigation  
 Northamptonshire

FIGURE TITLE  
**Trench 8: plan, section and photograph**

DRAWN BY	AO	PROJECT NO.	660638	FIGURE NO.
CHECKED BY	LM	DATE	17/01/2017	
APPROVED BY	SCC	SCALE@A3	1:20 & 1:100	<b>17</b>

Section AA

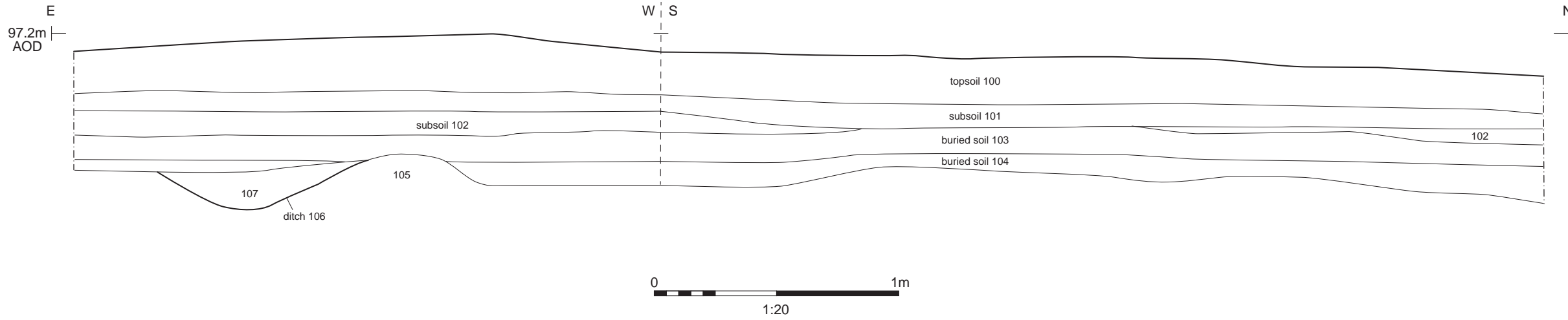

Archaeological feature

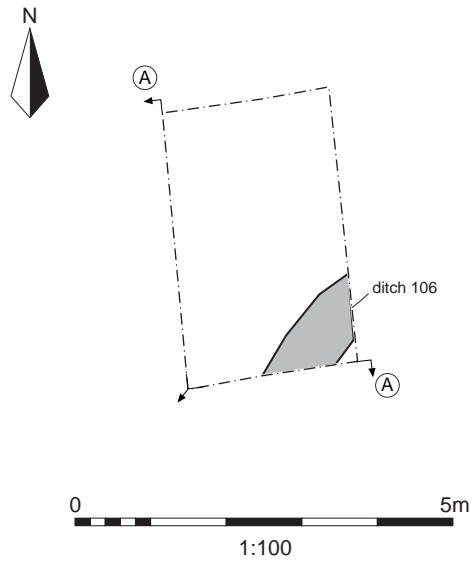

Test Pit 1, looking south (2m scale)

**Cotswold Archaeology**  
 Andover 01264 347630  
 Cirencester 01285 771022  
 Exeter 01392 826185  
 Milton Keynes 01908 564660  
 www.cotswoldarchaeology.co.uk  
 enquiries@cotswoldarchaeology.co.uk

PROJECT TITLE  
**DIRFT III Ridge and Furrow Investigation**  
 Northamptonshire

FIGURE TITLE  
**Test Pit 1: plan, section and photograph**

DRAWN BY	AO	PROJECT NO.	660638	FIGURE NO.
CHECKED BY	LM	DATE	17/01/2017	18
APPROVED BY	SCC	SCALE@A3	1:20 & 1:100	

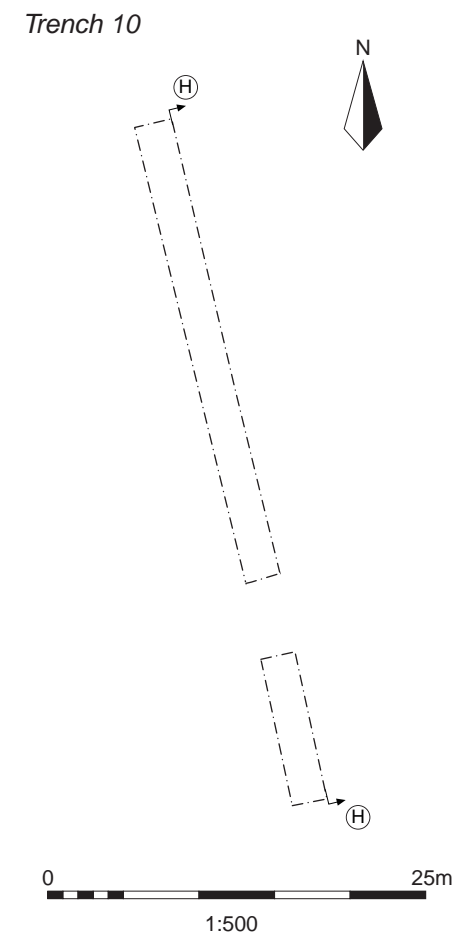
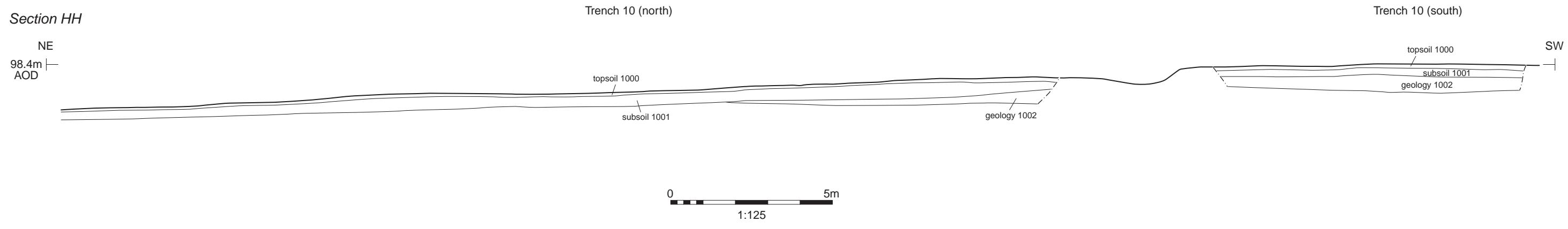

Trench 10 (north) looking north (2m scale)



Trench 10 (south) looking south (2m scale)



**Cotswold Archaeology**  
 Andover 01264 347630  
 Cirencester 01285 771022  
 Exeter 01392 826185  
 Milton Keynes 01908 564660  
 www.cotswoldarchaeology.co.uk  
 enquiries@cotswoldarchaeology.co.uk

PROJECT TITLE  
**DIRFT III Ridge and Furrow Investigation Northamptonshire**

FIGURE TITLE  
**Trench 10: plan, section and photographs**

DRAWN BY	AO	PROJECT NO.	660638	FIGURE NO.
CHECKED BY	LM	DATE	17/01/2017	<b>19</b>
APPROVED BY	SCC	SCALE@A3	1:125 & 1:500	

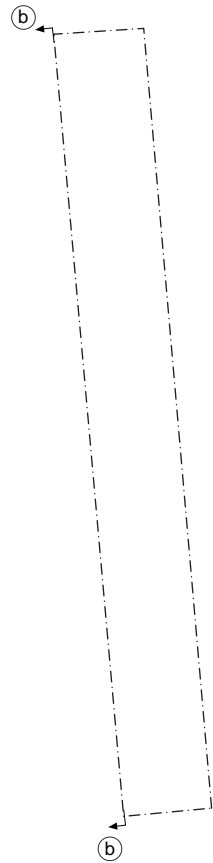
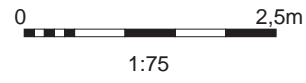
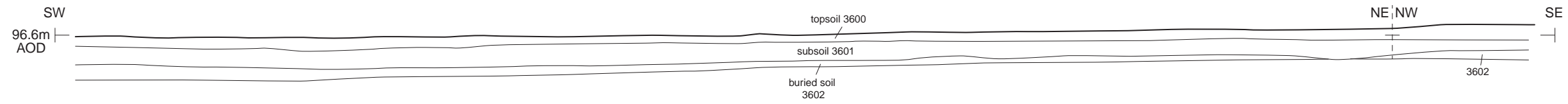
Section bb



Trench 36, looking north (2m scale)



**Cotswold Archaeology**  
 Andover 01264 347630  
 Cirencester 01285 771022  
 Exeter 01392 826185  
 Milton Keynes 01908 564660  
 www.cotswoldarchaeology.co.uk  
 enquiries@cotswoldarchaeology.co.uk

PROJECT TITLE  
**DIRFT III Ridge and Furrow Investigation**  
 Northamptonshire

FIGURE TITLE  
**Trench 36: plan, section and photograph**

DRAWN BY	AO	PROJECT NO.	660638	FIGURE NO.
CHECKED BY	LM	DATE	17/01/2017	20
APPROVED BY	SCC	SCALE@A3	1:75 & 1:200	

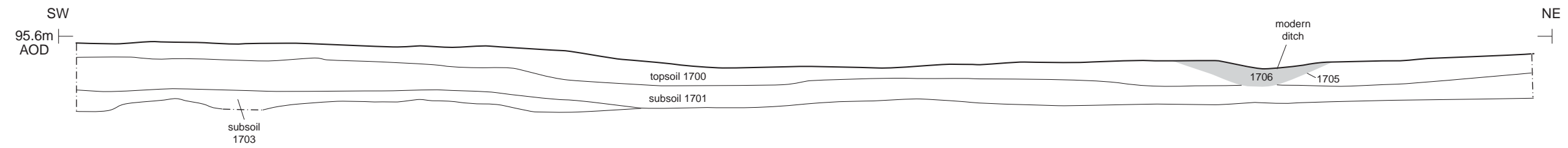
Section QQ



Section RR

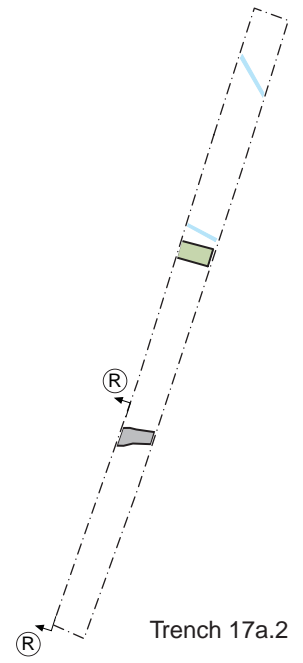
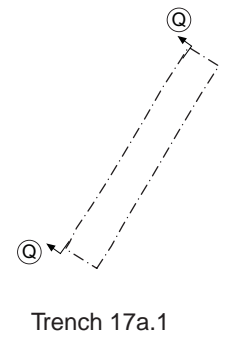
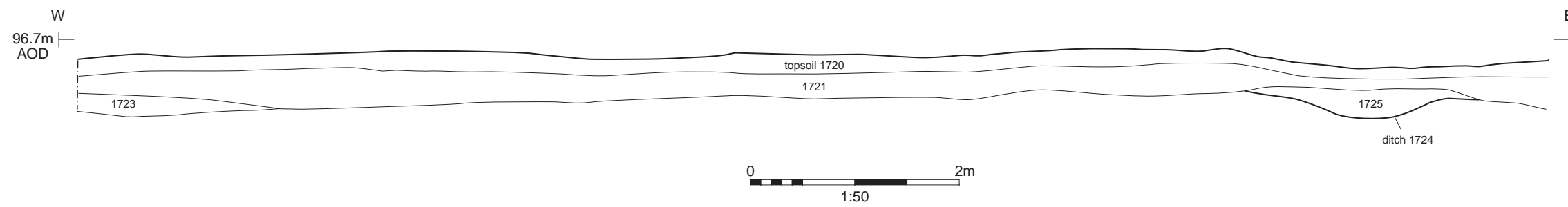

- Archaeological feature
- Field drain
- Furrow
- Modern feature



Trench 17a.1 looking north-east (2m scale)



Trench 17a.2 looking south-west (2m scale)

**Cotswold Archaeology**  
 Andover 01264 347630  
 Cirencester 01285 771022  
 Exeter 01392 826185  
 Milton Keynes 01908 564660  
 www.cotswoldarchaeology.co.uk  
 enquiries@cotswoldarchaeology.co.uk

PROJECT TITLE  
**DIRFT III Ridge and Furrow Investigation Northamptonshire**

FIGURE TITLE  
**Trench 17a: plan, sections and photographs**

DRAWN BY	AO	PROJECT NO.	660638	FIGURE NO.
CHECKED BY	LM	DATE	17/01/2017	<b>21</b>
APPROVED BY	SCC	SCALE@A3	1:50 & 1:500	

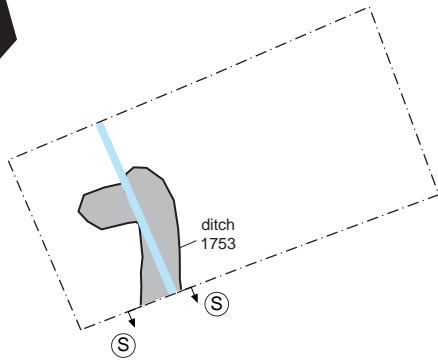

Section SS

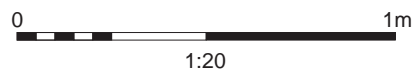
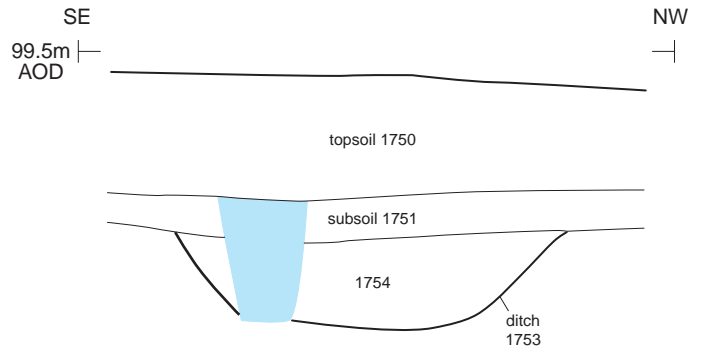

Ditch 1753, looking south-west (2m scale)

- Archaeological feature
- Field drain



Andover 01264 347630  
 Cirencester 01285 771022  
 Exeter 01392 826185  
 Milton Keynes 01908 564660  
 www.cotswoldarchaeology.co.uk  
 enquiries@cotswoldarchaeology.co.uk

PROJECT TITLE

DIRFT III Ridge and Furrow Investigation  
 Northamptonshire

FIGURE TITLE

Trench 17b: plan, section and  
 photograph

DRAWN BY	AO	PROJECT NO.	660638	FIGURE NO.
CHECKED BY	LM	DATE	17/01/2017	<b>22</b>
APPROVED BY	SCC	SCALE@A4	1:20 & 1:200	

Section OO

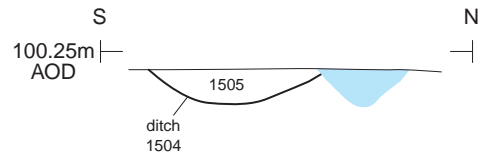

Section PP

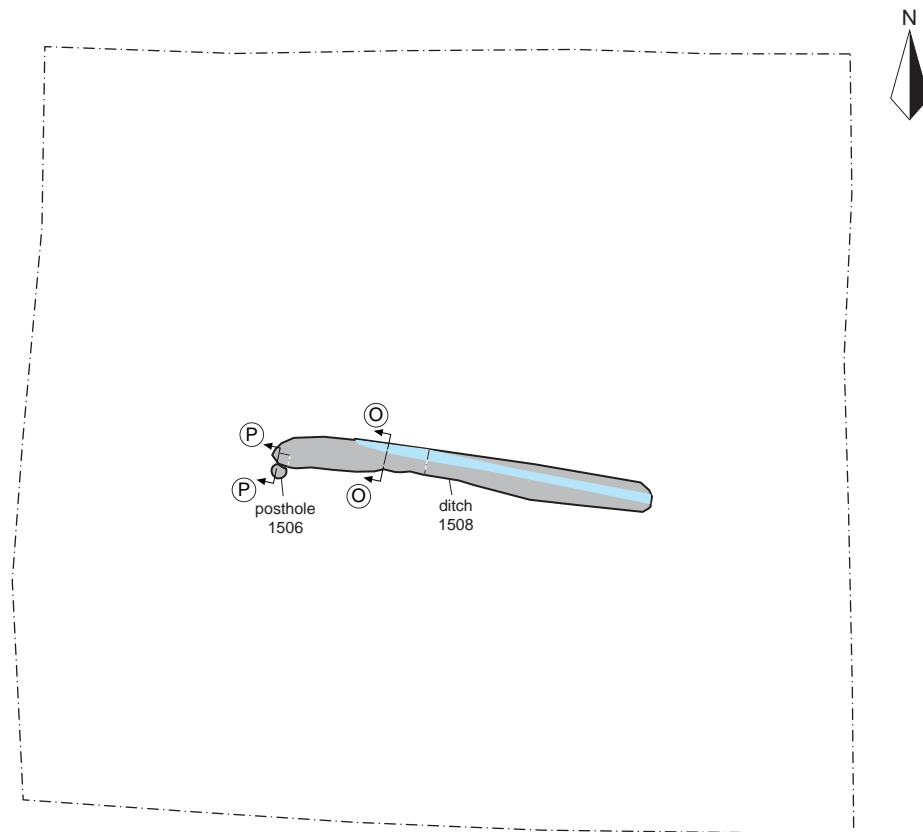
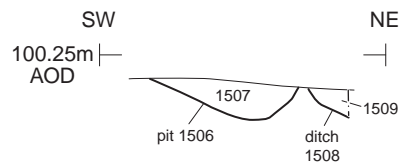

- Archaeological feature
- Field drain

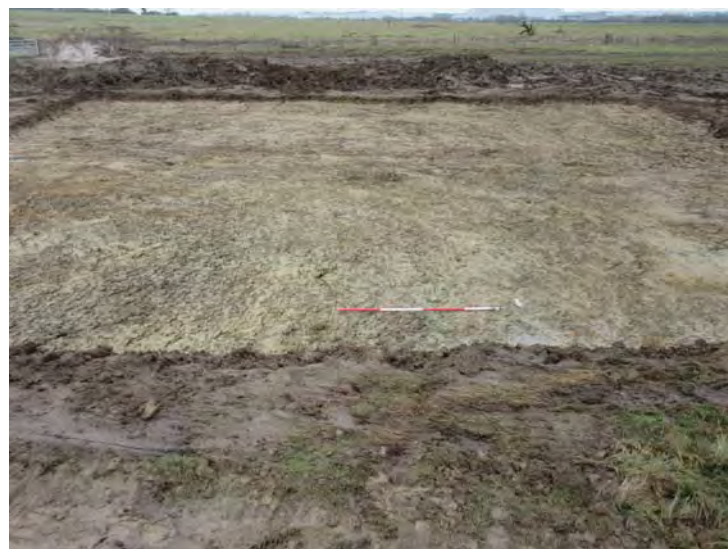

Trench 15, looking south (2m scale)

**Cotswold Archaeology**  
 Andover 01264 347630  
 Cirencester 01285 771022  
 Exeter 01392 826185  
 Milton Keynes 01908 564660  
 www.cotswoldarchaeology.co.uk  
 enquiries@cotswoldarchaeology.co.uk

PROJECT TITLE  
**DIRFT III Ridge and Furrow Investigation**  
 Northamptonshire

FIGURE TITLE  
**Trench 15: plan, sections and photograph**

DRAWN BY	AO	PROJECT NO.	660638	FIGURE NO.
CHECKED BY	LM	DATE	17/01/2017	<b>23</b>
APPROVED BY	SCC	SCALE@A3	1:20 & 1:200	



Section DD

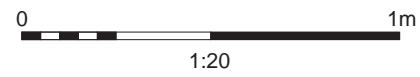
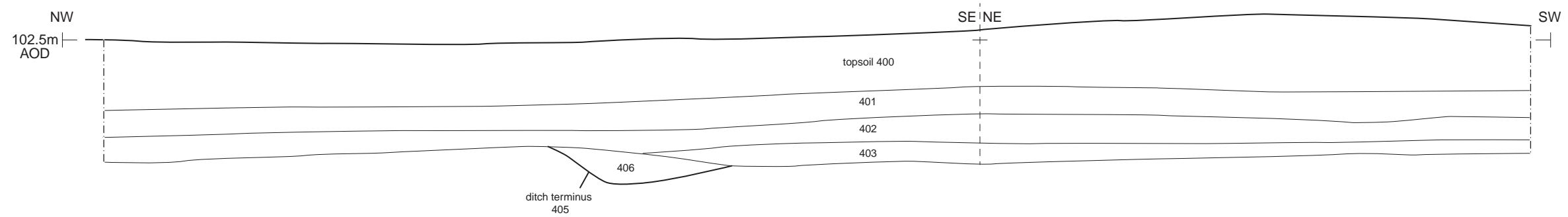

Section EE

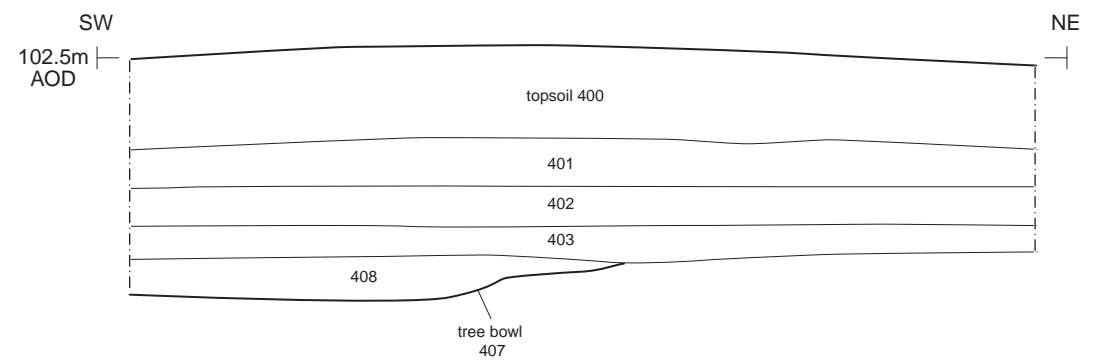

- Archaeological feature
- Tree bowl

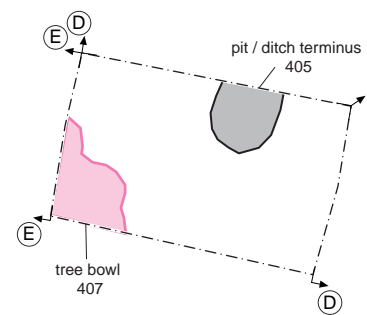

Test Pit 4, looking north (2m scale)

**Cotswold Archaeology**  
 Andover 01264 347630  
 Cirencester 01285 771022  
 Exeter 01392 826185  
 Milton Keynes 01908 564660  
 www.cotswoldarchaeology.co.uk  
 enquiries@cotswoldarchaeology.co.uk

PROJECT TITLE  
**DIRFT III Ridge and Furrow Investigation**  
 Northamptonshire

FIGURE TITLE  
**Test Pit 4: plan, sections and photograph**

DRAWN BY	AO	PROJECT NO.	660638	FIGURE NO.
CHECKED BY	LM	DATE	17/01/2017	24
APPROVED BY	SCC	SCALE@A3	1:20 & 1:100	

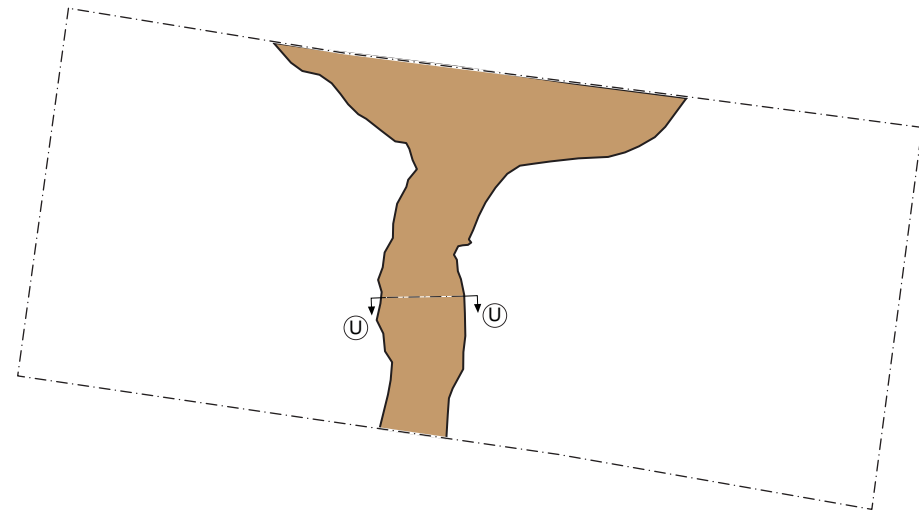

Section UU

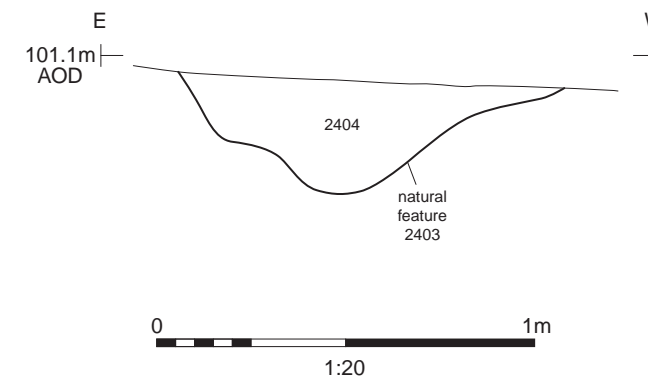

 Natural feature



Trench 24, looking north-west (2m scale)

 Cotswold Archaeology  
 Andover 01264 347630  
 Cirencester 01285 771022  
 Exeter 01392 826185  
 Milton Keynes 01908 564660  
 www.cotswoldarchaeology.co.uk  
 enquiries@cotswoldarchaeology.co.uk

PROJECT TITLE  
 DIRFT III Ridge and Furrow Investigation  
 Northamptonshire

FIGURE TITLE  
**Trench 24: plan, section and photograph**

DRAWN BY	AO	PROJECT NO.	660638	FIGURE NO.
CHECKED BY	LM	DATE	17/01/2017	25
APPROVED BY	SCC	SCALE@A3	1:20 & 1:100	



26 Trench 25 looking south-west (2m scale)



Andover 01264 347630  
 Cirencester 01285 771022  
 Exeter 01392 826185  
 Milton Keynes 01908 564660  
[www.cotswoldarchaeology.co.uk](http://www.cotswoldarchaeology.co.uk)  
[enquiries@cotswoldarchaeology.co.uk](mailto:enquiries@cotswoldarchaeology.co.uk)

PROJECT TITLE

DIRFT III Ridge and Furrow Investigation  
 Northamptonshire

FIGURE TITLE

Photograph

DRAWN BY AO PROJECT NO. 660638  
 CHECKED BY LM DATE 17/01/2017  
 APPROVED BY SCC SCALE@A4 N/A

FIGURE NO.

26

Section VV

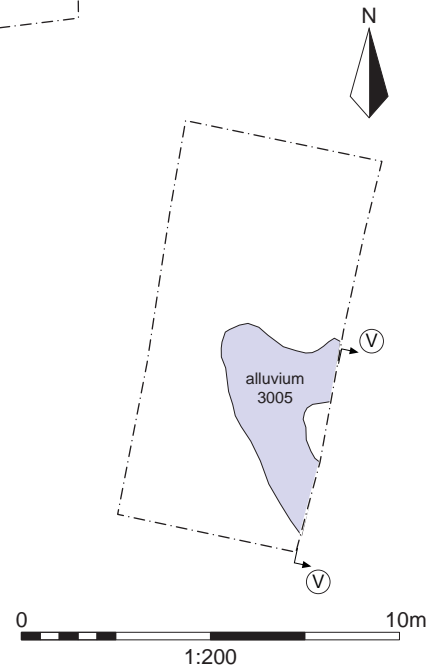
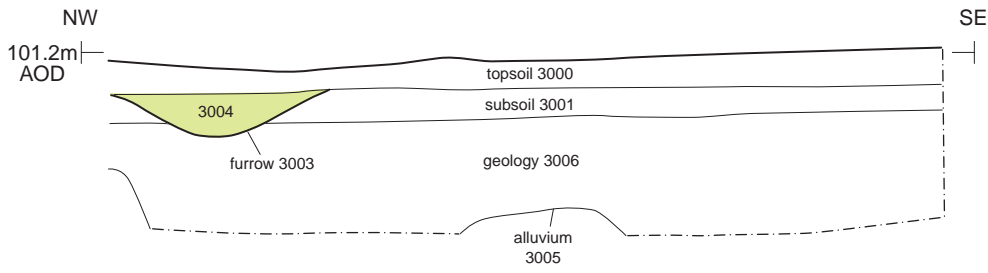

Trench 30, looking south-west (2m scale)

- Furrow
- Geology



Andover 01264 347630  
 Cirencester 01285 771022  
 Exeter 01392 826185  
 Milton Keynes 01908 564660  
[www.cotswoldarchaeology.co.uk](http://www.cotswoldarchaeology.co.uk)  
[enquiries@cotswoldarchaeology.co.uk](mailto:enquiries@cotswoldarchaeology.co.uk)

PROJECT TITLE

DIRFT III Ridge and Furrow Investigation  
 Northamptonshire

FIGURE TITLE

Trench 30: plan, section and  
 photograph

DRAWN BY AO PROJECT NO. 660638  
 CHECKED BY LM DATE 17/01/2017  
 APPROVED BY SCC SCALE@A4 1:50 & 1:200

FIGURE NO.

27

Section WW

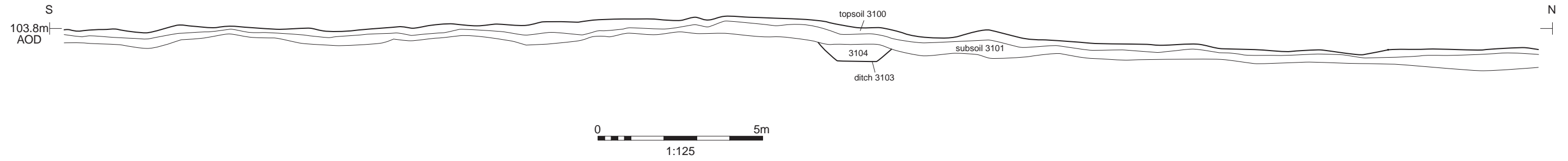

Trench 31, looking south (2m scale)



Ditch 3103, looking east (2m scale)



Trench 31, looking north (2m scale)

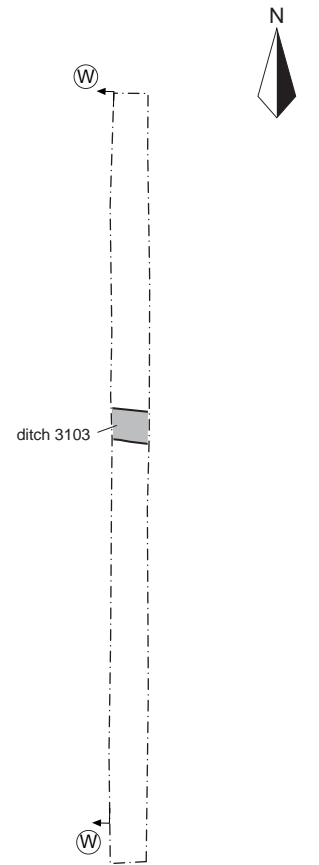

Archaeological feature

**Cotswold Archaeology**  
 Andover 01264 347630  
 Cirencester 01285 771022  
 Exeter 01392 826185  
 Milton Keynes 01908 564660  
 www.cotswoldarchaeology.co.uk  
 enquiries@cotswoldarchaeology.co.uk

PROJECT TITLE  
**DIRFT III Ridge and Furrow Investigation  
 Northamptonshire**

FIGURE TITLE  
**Trench 31: plan, section and  
 photographs**

DRAWN BY	AO	PROJECT NO.	660638	FIGURE NO.
CHECKED BY	LM	DATE	17/01/2017	<b>28</b>
APPROVED BY	SCC	SCALE@A3	1:125 & 1:500	

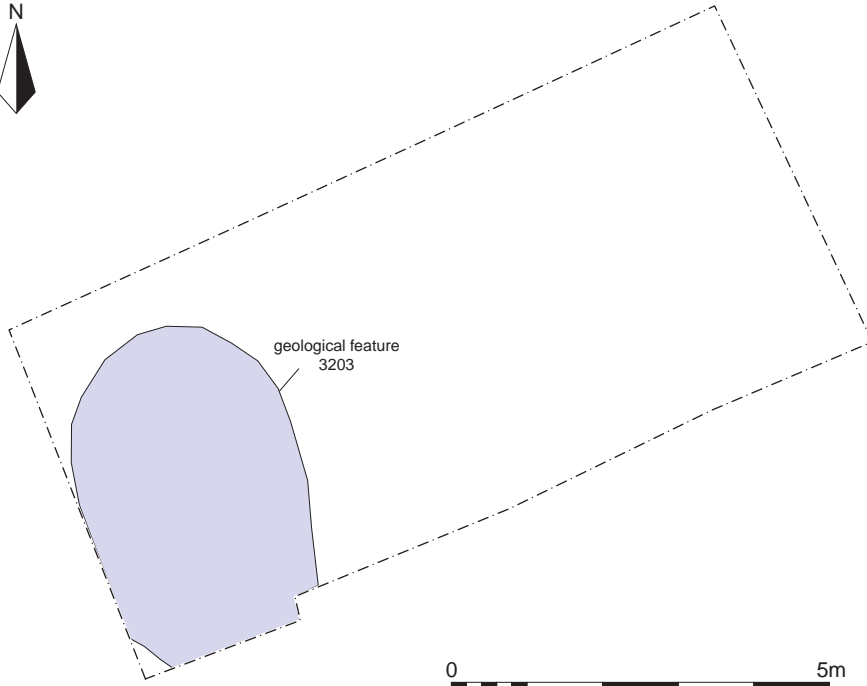

Trench 32, looking south-west (2m scale)

 Geological feature



Andover 01264 347630  
Cirencester 01285 771022  
Exeter 01392 826185  
Milton Keynes 01908 564660  
www.cotswoldarchaeology.co.uk  
enquiries@cotswoldarchaeology.co.uk

PROJECT TITLE

DIRFT III Ridge and Furrow Investigation  
Northamptonshire

FIGURE TITLE

Trench 32: plan and photograph

DRAWN BY AO PROJECT NO. 660638  
CHECKED BY LM DATE 17/01/2017  
APPROVED BY SCC SCALE@A4 1:100

FIGURE NO.

29

Section FF

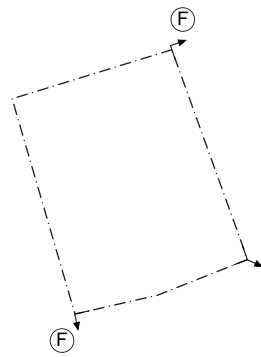
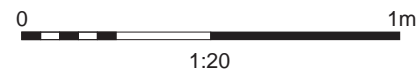
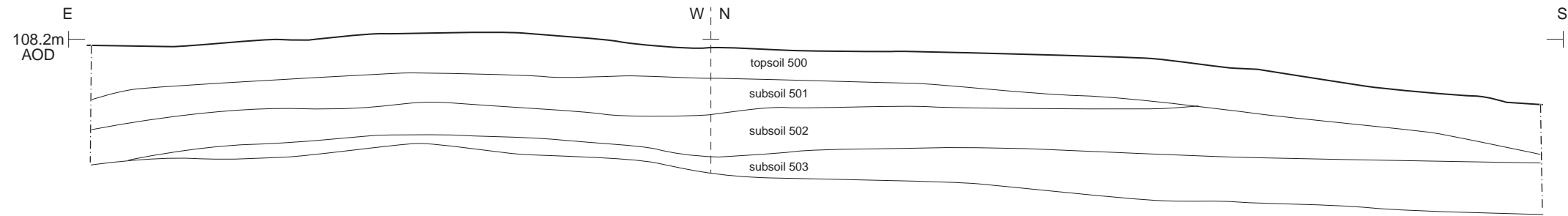

Test Pit 5, looking west (2m scale)

**Cotswold Archaeology**  
 Andover 01264 347630  
 Cirencester 01285 771022  
 Exeter 01392 826185  
 Milton Keynes 01908 564660  
 www.cotswoldarchaeology.co.uk  
 enquiries@cotswoldarchaeology.co.uk

PROJECT TITLE  
**DIRFT III Ridge and Furrow Investigation  
 Northamptonshire**

FIGURE TITLE  
**Test Pit 5: plan, section and  
 photograph**

DRAWN BY	AO	PROJECT NO.	660638	FIGURE NO.
CHECKED BY	LM	DATE	17/01/2017	<b>30</b>
APPROVED BY	SCC	SCALE@A3	1:20 & 1:100	



31 Trench 33, looking north-east (2m scale)



Andover 01264 347630  
 Cirencester 01285 771022  
 Exeter 01392 826185  
 Milton Keynes 01908 564660  
 www.cotswoldarchaeology.co.uk  
 enquiries@cotswoldarchaeology.co.uk

PROJECT TITLE

DIRFT III Ridge and Furrow Investigation  
Northamptonshire

FIGURE TITLE

Photograph

DRAWN BY	AO	PROJECT NO.	660638	FIGURE NO.
CHECKED BY	LM	DATE	17/01/2017	<b>31</b>
APPROVED BY	SCC	SCALE@A4	N/A	



Section TT

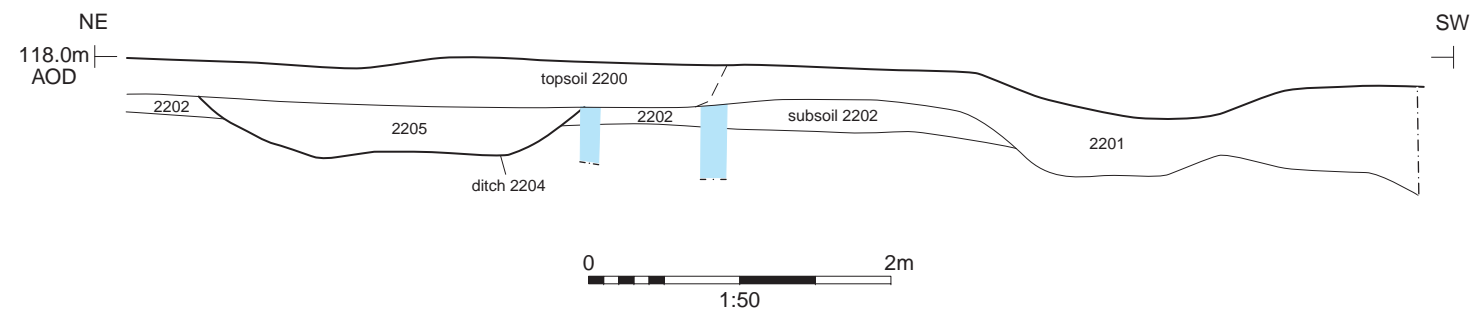

Field drain

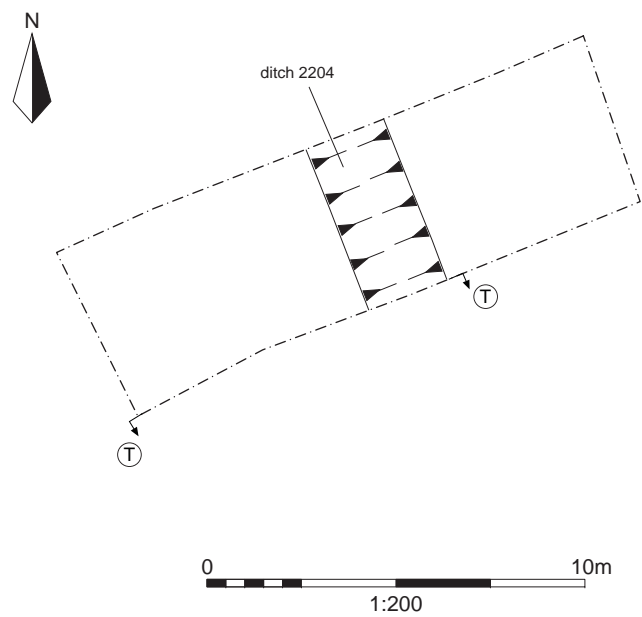

Trench 22, looking south-west (2m scale)

 Andover 01264 347630  
 Cirencester 01285 771022  
 Exeter 01392 826185  
 Milton Keynes 01908 564660  
 www.cotswoldarchaeology.co.uk  
 enquiries@cotswoldarchaeology.co.uk

PROJECT TITLE  
 DIRFT III Ridge and Furrow Investigation  
 Northamptonshire

FIGURE TITLE  
**Trench 22: plan, section and  
 photograph**

DRAWN BY	AO	PROJECT NO.	660638	FIGURE NO.
CHECKED BY	LM	DATE	17/01/2017	32
APPROVED BY	SCC	SCALE@A3	1:50 & 1:200	

#### **Andover Office**

Stanley House  
Walworth Road  
Andover  
Hampshire  
SP10 5LH

t: 01264 347630

#### **Cirencester Office**

Building 11  
Kemble Enterprise Park  
Cirencester  
Gloucestershire  
GL7 6BQ

t: 01285 771022

#### **Exeter Office**

Unit 53  
Basepoint Business Centre  
Yeoford Way  
Marsh Barton Trading Estate  
Exeter  
EX2 8LB

t: 01392 826185

#### **Milton Keynes Office**

41 Burners Lane South  
Kiln Farm  
Milton Keynes  
Buckinghamshire  
MK11 3HA

t: 01908 564660