

## **Excavations at the Baptist Chapel Burial Ground, Littlemore, Oxford**

By Róisín McCarthy, Sharon Clough and Andrew Norton with contributions by Paul Blinkhorn

### **Summary**

In October 2009 Oxford Archaeology (OA) carried out the excavation of the cemetery at Littlemore Baptist Chapel, Oxford (NGR 5349 0273). A total of 31 graves dating to the latter half of the 19th century were excavated during the excavations. The remains of 30 individuals survived, and the skeletal remains pointed towards a population suffering poor nutrition in childhood but longevity in adulthood. Census and memorial stone data also pointed to a lower-middle class artisan population. Neoplastic disease prevalence was notably high, making the assemblage unique in this respect. The remains of 31 coffins were revealed, which dated from the late 1850s, sometime after the foundation of the chapel. Evidence for post-medieval quarrying were also recorded.

### **Introduction**

The chapel lies on the west side of Chapel Lane in the parish of Littlemore (Fig. 1), which formed part of the Hundred of Bullingdon. The excavation took place following the demolition of the existing chapel, and in advance of the erection of a two-storey building containing a community hall and flats (Planning Application: 07/02274/FUL). All work was carried out in accordance with standard fieldwork practices as detailed in the OA Field Manual (Wilkinson 1999), and the Church of England and English Heritage (2005) guidance for best practice for treatment of human remains.

The site was subject to a desk-based assessment (OA 2003) and Davis's map of 1797 demonstrates that the site lay within open fields in the post-medieval (and probably medieval) period. The Cowley Tithe Map and Award (1853) shows that the site lay in an area comprising allotment, arable and meadow with one field given over partly to pasture.

The chapel was recorded during a visit in June 1984 and the records are held by the Oxfordshire SMR. The chapel was most likely constructed in 1807 or 1809 and made of rubble stone with much rendering. From about 1804 Mr Hinton, the minister of the New Road Baptist chapel, occasionally preached to 'a few' Baptist dissenters at Littlemore. His services were so well attended that it was decided to erect a small chapel. The chapel was opened in 1807, following a donation of £100 from Mr Pasco a fellow Baptist (VCH 1957, Vol 5, 214).

The chapel is probably the meeting house registered in Littlemore on June 22nd, 1807 (Bodleian MS Oxf.; Dioc. Papers) but the return for the 1851 Religious Census from a Baptist Chapel in Littlemore gives the date of erection as about 1809 - with seating for 150.

The chapel was thought to have been extended to the south-east sometime after 1850 and could have easily accommodated a congregation of 30, the recorded attendance at an evening meeting on the 31st March 1851. The only surviving record of any burials comprises the inscriptions on gravestones, which were relocated prior to the construction of the extension. The date of the last known burial was 1888, and the earliest was in 1862, suggesting that the extension took place after 1888. A total of 17 individuals are commemorated on nine gravestones, and a further three gravestones with illegible inscriptions must commemorate at least a further three individuals. A full detail of the inscriptions can be found below.

### **The Skeletal Remains**

By Róisín McCarthy

A total of 30 skeletons dating to the latter half of the 19th century were excavated from the burial ground. Demographic data relating to the minimum number of individuals, biological sex and age-at-death of all interred individuals is presented. In addition, details of levels of preservation and pathological and occupational stress markers on the bones and teeth are discussed. The space available in this report is insufficient to provide detailed descriptions of all pathological changes encountered and for which only a wide range of diagnoses could be forwarded. Rather it is the focus of this report to provide a generalised view as far as possible of the health status and lifeways of the Particular Baptist congregation of Littlemore Chapel towards the end of the 19th Century as evidence by their skeletal remains. Interesting comparisons with a number of broadly contemporary burial assemblages, including several directly comparable Non-Conformist burial grounds, are drawn wherever possible.

### ***Background to the skeletal assemblage***

From surviving burial-related artefacts and death register records it would appear that the Littlemore Baptist assemblage represented individuals from the so-called 'middle-classes' of the Victorian period social stratum. Four individuals were recovered with associated biographical information via partially legible inscriptions on *departum* plates, one of whom was a retired Baptist minister (Skeleton 74). Extant memorial stones allowed the identification of a further three individuals based on their stratigraphic relationships within the grave plots. Totalling 7 individuals, this portion of the assemblage is referred to hereafter as

the named sample. The remaining 23 individuals who had no discernible biographical information at the time of compilation of this report are referred to here as the unnamed sample. All 30 individuals underwent full osteological analysis, the results of which are outlined below.

### ***Burials and cemetery layout***

The majority of burials (71%; n=22/31) were concentrated on the eastern side of the burial ground and orientated south-east to north-west. A further four burials, all of which were located at the western end of the burial ground were orientated south-west to north-east (Fig. 1). A deviation from the typical Christian tradition of west-east orientated graves is not unusual for a Non-Conformist cemetery whose members were often keen to differentiate themselves from the Church of England. All skeletons were interred in simple earth-cut plots and associated with the remnants of coffin material with the exception of burial features 71 and 79 from which no human bone was recovered. Forty-six percent of the total number of skeletons (n=14/30) were excavated from shared plots with one or more individuals; frequently a single adult sharing with one or more subadults.

### ***Methods***

#### *Assessment of assemblage preservation: erosion, fragmentation and completeness*

Skeletons were each assessed for their level of preservation via an examination of the degree of fragmentation, completeness and taphonomic erosion observable on the bones. Fragmentation and completeness were classified into one of four groups relating to the percentage volume of bones affected; 0-25% affected, 25-49% affected, 50-74% affected and 75-100% affected. The degree of taphonomic erosion (*e.g.* due to weathering, water erosion, root action etc.) of skeletal elements was scored using McKinley's (2004) grading system. Other post-mortem changes to the bone (*e.g.* gnawing and staining) were also described and the affected skeletal element(s) noted.

#### *Estimation of Minimum Number of Individuals (MNI)*

The common use of family plots and the practice of interring more than one individual in a single plot at Littlemore meant that evidence of disturbance was to be expected, at least to a small degree. However, in general intercutting of grave plots was virtually non-existent. Where appropriate, duplicate skeletal elements or skeletal elements demographically inconsistent with the primary skeleton were identified and re-bagged as 'intrusive bone'. In

one case (context 73) the commingled remains of two infants warranted sub-numbering of the original burial context number and so each individual was assigned a new skeleton number: 73a and 73b. The presence of two subadults within this grave plot (although not known by the author at the time of analysis on account of the "blind-testing" analysis procedure; see Estimation of Biological Age and Sex below) was corroborated by legible *departum* plates recovered from the grave fill during excavation. In all other cases an MNI of one individual was determined for each of the remaining twenty-seven burial contexts.

#### *Estimation of biological age and sex*

Surviving *departum* plate inscriptions for this assemblage display the name, age and sex of the deceased. Despite the relatively small size of the assemblage, this provided the author with an opportunity to "blind-test" the accuracy of ageing and sexing techniques commonly employed in standard osteoarchaeological analyses, by comparing the results with the chronological age and sex of the named sample once osteological analysis was complete (results discussed below).

Subadult age estimation was based primarily on observations of the stage of dental development (Moorrees *et al.*, 1963; Ubelaker 1989) and the degree of epiphyseal fusion (Scheuer and Black 2000). Where possible long bone lengths were used to supplement dental development age estimates and as a basis for aging foetuses and perinates (*i.e.* "new-borns") using methods developed by Fazekas and Kósa (1978), and by Maresh (1970). Adult age estimates were determined through a combination of methods including assessment of late-fusing skeletal elements (Scheuer and Black 2000) and degenerative changes of the auricular surface and pubic symphyses (Buckberry and Chamberlain 2004; Brooks and Suchey 1990). Observations relating to the degree of cranial suture closure (Meindl and Lovejoy 1985) were included as a complementary aid to aging only. Observation of the degree of attrition in mandibular and maxillary molars as a reflection of increasing age (Miles 1963) recorded and present in the archive but not reported on here. In recent studies this method has proven dissatisfactory when assessing age in populations consuming the highly-processed, soft diets typical of the Victorian period in Britain (Boston *et al.* 2005; Boyle 2004). Skeletons were assigned to one of twelve age categories outlined in Table 1.

Sexing of adults was determined via observations of sexually dimorphic traits of the skull and pelvis (Buikstra and Ubelaker 1994). As the pelvis reflects skeletal adaptation to child-bearing in females it is considered the most reliable indicator of biological sex (Roberts 2009). Supplementary post-cranial measurements known to exhibit sexually dimorphic ranges

between males and females were also taken (Workshop 1980). No attempt was made to determine the sex of the subadults in the Littlemore assemblage, in accordance with accepted practice, as currently no methods exist which are proven to reliably sex subadult individuals (Buikstra and Ubelaker 1995).

*Metrical and non-metrical analysis*

In line with recommendations of Mays (1998, 89), Buikstra and Ubelaker (1994), and standard methodological practice, a suite of cranial and post-cranial measurements covering the various regions of the skull and skeleton was taken for adult individuals with sufficiently intact crania and/or mandibles and post-cranial elements. Measurements were taken with the use of spreading and sliding callipers as well as an osteometric board. Subadult metrics were excluded from analysis (as is normal practice) since their skeletons were still developing and had not assumed their final proportions by the time of death. Over 66% (n=10/15) of adults yielded a complete set of cranial measurements whilst 100% of adults (n=15/15) yielded at least one post-cranial measurement from the standard list.

*Table 1: Age Categories Employed in Present Analysis*

Category	Age Range
Adult	18+ yrs
Young Adult	18-25 yrs
Prime Adult	26-35 yrs
Mature Adult	36-45 yrs
Older Adult	45+ yrs
Adolescent	13-17 yrs
Older Child	6-12 yrs
Young Child	2-5 yrs
Infant	1mth-2yrs
Neonate	Birth □ 1mth
Perinate	Around birth <1wk
Foetus	3 <sup>rd</sup> month (in utero) to Birth

Stature was determined by applying the Trotter and Gleser technique (1952, 79□123) of measuring long-bone lengths on an osteometric board and applying a regression formula which relates to the sex of the individual to translate this initial figure into height during life. Only those sexed individuals with a complete femur were considered as this bone has proven to give the most accurate results for stature in British populations (Waldron 1998).

A non-metric trait is any minor skeletal variant or anomaly that is not normally recorded by measurement (Mays 1998). These anomalies generally fall under one of seven classifications outlined by Mays (1998, 111) which include: *i*) variations in the number of bones or teeth; *ii*) anomalies of bone fusion; *iii*) variations in bony foramina (blood vessel/ nerve openings); *iv*) joint facet variation; *v*) hyperostosis (excesses of bone formation); *vi*) hypo-ostoses (localised bone deficiencies) and *vii*) variation in tooth crown morphology. In general non-metric traits can occur both bilaterally and unilaterally, the former expression in most cases indicating a genetic cause whilst the latter is thought to be more indicative of environmental influences (Mays 1998, 111). Non-metric variation was recorded systematically for the Littlemore adult assemblage following the guidelines set out by Berry and Berry (1967) and Buikstra and Ubelaker (1994). Traits were recorded as 'present' or 'absent', noting the side of the bone where applicable. Non-metric traits in the subadult assemblage were not recorded systematically in the same way but rather noted when 'present' only. Again, due to the constantly developing nature of the juvenile skeleton these data were not included in the calculation of non-metric trait prevalence rates in the Littlemore assemblage.

#### *Assessment of dental and skeletal health*

All observable teeth, mandibles and maxillae were examined for signs of pathological changes; primarily evidence of caries (*i.e.* dental decay), calculus (*i.e.* levels of tartar), periapical abscesses, dental enamel hypoplasia, periodontal disease and dental anomalies (*e.g.* overcrowding and malocclusion). Hypoplastic enamel defects were recorded by assessing the type (*i.e.* pit, line or groove) and quantity of defects present on the tooth crown. In notable cases, namely individuals with high levels of skeletal pathology, an estimate of the timing of the occurrence of the defects during life was forwarded based on dental development stages described by Moorrees *et al.* (1963). Due to time constraints of analysis this level of detail was not possible for all individuals, however. Periodontal disease was recorded using Ogden's (2005) 5-point grading system which assesses changes in alveolar bone morphology rather than the degree of tooth root exposure which is not necessarily influenced by the effects of periodontal disease. Carious lesions in the teeth were recorded following the recommendations of Hillson (2001) and the grading system of Lukacs (1989), noting the size of the lesion (*i.e.* 'small', 'medium' or 'gross') and the location of the lesion on the tooth crown.

Observable bone surfaces were examined for pathological conditions in line with recommendations outlined by Buikstra and Ubelaker (1994). Descriptions of pathological

lesions were further informed by published guidelines relating to particular skeletal diseases, where available. An example of one such method is Lewis's (2004) lesion typology model used for description of non-specific endo and ectocranial lesions (*i.e.* lesions occurring on the external and internal surfaces of the skull vault). All observed lesions were described in detail and a differential diagnosis assigned with reference to standard palaeopathology texts (*e.g.* Aufderheide and Rodríguez-Martín 1998; Ortner and Puschar 1981; Ortner 2003). It is worth noting that diagnostic tools available in clinical cases for example, such as the opportunity to question the patient's symptoms and the chance to examine soft tissue lesions are not available to the osteoarchaeologist and these limitations should be taken into account when considering the information contained in this report.

Basic statistical comparisons were drawn using crude and true prevalence rate calculations. The 'crude prevalence rate' (CPR) refers to the number of cases of a condition, for example a particular disease, out of the total number of individuals in the sample population. The 'true prevalence rate' (TPR) refers to the number of cases of a condition relative to the total number of skeletal elements present on which the condition could possibly occur. For the purposes of crude prevalence rate calculations, pathological conditions were broadly categorized according to aetiology: congenital/ developmental conditions, metabolic disorders, trauma, joint disease, infectious disease and neoplastic disease. In order to determine the true prevalence rate of a particular lesion in the assemblage, the number of observable skeletal elements on which that lesion could possibly occur were totalled from which percentage rates were calculated.

## **Results**

### *Preservation and completeness*

Preservation of human remains is a highly variable factor within cemetery assemblages due largely to the interaction of a wide range of taphonomic factors within the burial environment. For this reason uniform preservation patterns across an assemblage are rarely, if ever, encountered. Likewise, the preservation of funerary artefacts and paraphernalia depend entirely on the micro-environment within each grave and coffin (Henderson 1987, 43).

Specific factors known to affect preservation and completeness of bone in cemetery assemblages such as Littlemore include the pH values of the soil, depth of burial, in-situ compression and quality of excavation and post-excavation treatment (McKinley 2004; Brothwell 1981, 7-9). The use of absorbent materials in coffin construction, such as sawdust,

bran or lime may also have an affect on preservation levels as well as the age, sex and bone health of the individual interred (Boston 2005).

In general, preservation of the Littlemore assemblage was found to be "very good" if not "excellent" in most cases (60%, n=18/30). Fifty-percent of skeletons (n=15/30) were categorised as greater than 75% complete and a further 16.7% (n=5/30) had 50-75% of skeletal elements complete. Levels of taphonomic erosion were minimal and the vast majority of bone surfaces had a fresh appearance. Over 66% (n=20/30) of skeletons exhibited an average McKinley (2004) grade of 0 (i.e. bone surfaces have a fresh appearance) or 1 (i.e. minimal erosion on the bone surfaces with clear bone surface morphology). No discernible pattern of differential levels of preservation was noted between the sexes, however it would appear that age-at-death played an important role in bone survival. Of the 10 individuals classified as being of overall "poor" preservation, 7 were subadults. In comparison to adult skeleton preservation where 53% (n=8/15) were considered as being of "excellent" overall preservation, just 20% (n=3/15) of subadults shared this level of preservation.

Under-representation of subadult remains in skeletal assemblages is a problem commonly cited in osteoarchaeological analyses. Certainly the pattern of preservation seen in the Littlemore assemblage supports the notion of preferential preservation of adult skeletal remains in certain conditions. Even more puzzling, perhaps, is the lack of cemetery organisation in terms of division of adults and subadults at Littlemore so that presumable taphonomic influences were more or less evenly distributed regardless of age-at-death. As mentioned previously, skeletons with underlying bone-weakening conditions (e.g. osteoporosis) tend to have poorer levels of preservation compared to their healthy counterparts in skeletal assemblages (McKinley 2004). The naturally porous, underdeveloped nature of immature subadult bone, coupled with the high rates of metabolic disorders seen in the Littlemore subadult assemblage (discussed below), may well be a significant factor in the differential pattern of preservation according to age-at-death seen here.

In general the excellent level of preservation that largely characterised the Littlemore skeletal assemblage tallies with broadly contemporary sites, such as St Luke's Illington (Boston *et al.* 2005, 185) and Spitalfields, London (Molleson and Cox 1993).

### ***Figure 2 Assemblage Composition***



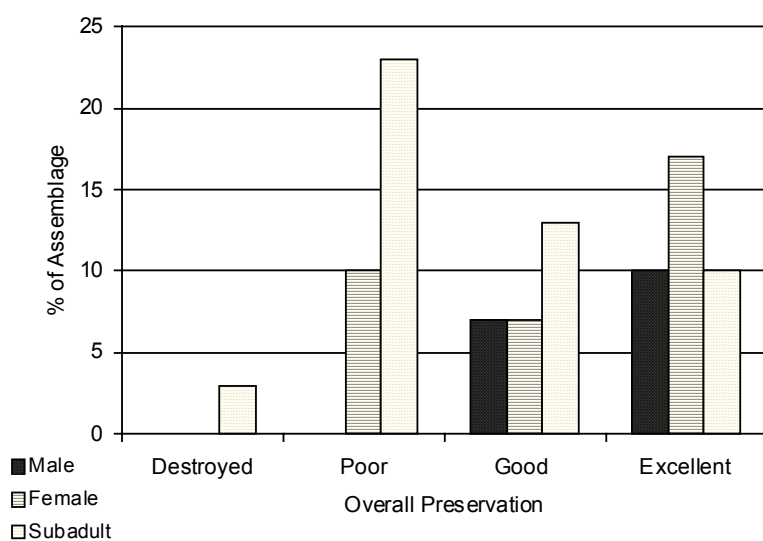

### *Subadult mortality*

Of the 30 individuals represented by the Littlemore skeletal assemblage, 50% (n=15/30) were adults whilst the remaining 50% were subadults. Such a high percentage of subadult representation is rarely reported for archaeological populations and is despite an apparent preferential loss of subadult bone compared to adult bone in the Littlemore cemetery burial environment. This poses the question of the possibility of yet more subadults having been buried at the Littlemore burial ground whose remains may have been lost to the apparently aggressive burial environment with respect to immature bone. Interestingly, in their discussion of mortality rates seen in post-medieval cemetery assemblages (which for the most part do not normally reflect such high rates of infant mortality) Roberts and Cox (2003, 302) attribute the apparent lack of infants to "preferential selection of the place of burial for middle classes". It would certainly appear that at Littlemore this was not the case, despite the Baptist doctrine of non-membership of children who, due to their young age, were considered incapable of making the decision to join. Strictly-speaking, burial in Baptist cemeteries were in principle reserved for "members" only, but this doctrine was seldom followed and children are frequently present in Baptist skeletal assemblages from the period (Powers 2010; Caffell and Clarke *in press*).

Of the 15 subadults identified in the assemblage the overwhelming majority (80%, n=12/15) died before the age of 2 giving a mortality rate of 40% (n=12/30) for the overall assemblage in the period between birth and 2 years. A further two individual lived to between 3 and 5 years and 4 and 5 years of age respectively prior to death, thereby increasing the mortality rate in the time between 0-5 years to 47% (n=14/30). These mortality rates fit closely with

census figures from the turn of the century where over 30% of all deaths were those of infants under 2 years of age and approximately 50% of deaths occurred before the age of 20 (Roberts and Cox 2003). Comparisons with other specifically Baptist skeletal assemblages highlights a striking uniformity in terms of child mortality rates. Of particular note is the mortality rate amongst subadults from Bow, London where 48% of the total assemblage was comprised of subadults (Powers 2009), 60% of whom died under the age of 7 years with a peak in mortality between the ages of 1 month to 6 years. Although a burial register is not available for the Littlemore Baptist Chapel during this period, it would appear that mortality rates are closely comparable to those seen from the burial register of the wider Baptist community of King's Lynn, Oxford (Boston *in press*). Here 45.1% of the population failed to reach adulthood and mortality peaked in infants under 2 years of age (*ibid.*, 5). Child mortality rates quoted in the burial registers of the broadly contemporary Quaker assemblage from Kingston-upon-Thames, London are slightly improved, with 21% of infants dying before the 12 months (Bashford and Sibun 2007).

These figures are somewhat at odds with those quoted from the comparable Church of England site of St. George's Church, Bloomsbury (Boston *et al.* 2009) which had a subadult mortality rate of just 6.94%. More comparable subadult mortality rates have been quoted at sites such as St. Martin's-in-the-Bull-Ring, Birmingham (Brickley and Western 2006) and Priory Yard, Norwich (Caffell and Holst *in press*) where 32.8% (of individuals from earth-cut burials) and 38.1% respectively were subadults.

Even taking into account the above comparative figures, the young infant mortality rate at Littlemore is still exceptionally high and exceeds even contemporary estimates of child mortality rates amongst the gentry and professional classes (*i.e.* one in five children; Chadwick 1840 cited in Rugg 1999, 216-217), to which the Littlemore Baptists largely belonged. In fact it would appear that the Littlemore Baptist sample is more in keeping with contemporary estimates of mortality rates amongst working-class children than those of a middle-class background (*i.e.* c. 50% subadult mortality; Chadwick 1840 cited in Rugg 1999, 216-217). Malnutrition, infectious diseases and poor living conditions are all major causes of young infant mortality and are in evidence in the subadult skeletal remains of the Littlemore assemblage (see *Palaeopathological Analysis*).

#### *Adult mortality and biological sex distribution*

A total of 15 individuals comprised the adult sample, with females outnumbering males by 2:1 (n=10; n=5). This rate slightly exceeds the 'normal' 1.46:1 ratio of females to males in

cemetery assemblages quoted by Mays and Faerman (2001). The Littlemore female-to-male ratio of burials is comparable to other Baptist skeletal assemblages such as West Butts Street, Poole, Dorset (McKinley 19??) and Priory Yard, Norwich (Caffell and Clarke, 20??) where 61% and 60.6% of adults respectively were female. Women commonly outnumbered men in early Baptist congregations due to the political, social and economic consequences suffered by male members of a non-conformist group (Caffell and Clarke, 17). Male members of non-Conformist groups were subject to prosecution for partaking in a religious group other than the Anglican state church. Political reforms of the 17th century with respect to toleration of non-Conformism (e.g. 1689 Act of Toleration), however, meant that religious persecution of Baptist members was not a factor during the period covered by the Littlemore internments.

Broad age categories were possible for all individuals from the adult sample. Although there were some instances of young adults with sufficient information to derive a more accurate age estimate, the data is presented in this report according to the age categories outlined in Table 1 for consistency. Seventy percent of females (n=7/10) and 40% of males (n=2/5) were aged as 'old adults' and overall account for the greatest number of individuals in the adult sample. A peak in mortality rates in old age tallies with estimates quoted by Roberts and Cox (2003) for the period.

**Table 2: Mortality Profile of Littlemore Assemblage**

Age Category	Number of Individuals		% of Assemblage	
Perinate	2		6.7	
Neonate	2		6.7	
Infant	8		26.7	
Child	3		10.0	
Total	15		50.1	
	# Male	# Female	% Male	% Female
Adolescent	0	0	0	0
Young Adult	1	3	3.0	10.0
Middle Adult	2	0	6.7	0
Old Adult	2	7	6.7	23.3
Total	5	10	16.4	33.3

Young females appear to have suffered a higher mortality rate than their male counterparts accounting for 20% of the total adult sample (n=3/15). Risks associated with childbirth, including eclampsia, haemorrhage, malpresentation and infection, were a major contributing factor to mortality rates in young women of the period (Roberts and Cox 2003). At the end of the 19th century maternal mortality rates were approximately 5 in every 1000 births (Roberts and Cox 2003, 316) and may explain the higher rate seen here. Numerous other causes of

death did exist, however, and the fatality rates related to lung infections amongst young females was a serious concern of the time. Just one male was aged as a young adult in the Littlemore assemblage. Middle adults (*i.e.* individuals with an age-at-death of between 35-50 years) account for just 20% (n=3/15; one female and two males) of the total adult sample.

The adult mortality rate of the Littlemore assemblage corresponds with those reported at Priory Yard, Norwich (Caffell and Clarke, 2010) and St. Marylebone, London (Powers, 2010) where adult deaths appear to have peaked in the older age categories with a relative under-representation of young adults, particularly young adult males (Table 3).

The osteological age of an individual is estimated from the age-related skeletal changes known to occur during periods of growth and degeneration in an individual (see *Estimation of Biological Age and Sex*). Chronological age refers to the actual real age in calendar years/months of an individual and may not always directly correlate with the osteological age an individual. Sexual dimorphism in skeletal populations from the Victorian period in Britain is not distinct, and difficulties may be encountered in determining biological sex from the skeleton of an individual from this period, particularly if the individual is elderly (Walker 2006). Biographical evidence derived from *departum* plates and the interpretation of the stratigraphic sequence in combination with extant memorial inscriptions was available for 7 individuals.

**Figure 3 Mortality Profile based on Osteological Age Estimates**

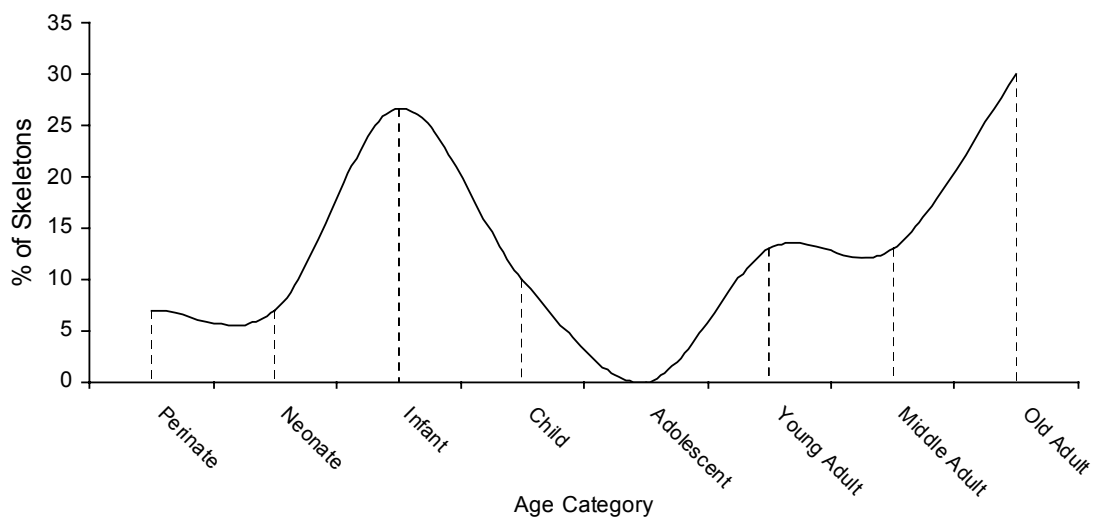

In general sexing techniques proved to be 100% accurate for adults whilst aging techniques proved somewhat less effective. One skeleton, that of Isaac Grubb, was over-aged by

approximately 4-14 years, although the younger end of the age range was preferred during analysis due to the youthful appearance of the majority of joint surfaces. Two young infant sisters, Catherine and Edith Seaman, were both under-aged by close to 5 months and 1 month respectively, although gross pathological changes in the dentition of the former sister may account for this to some degree. The remaining four adults of the named assemblage were all assigned osteological age estimates with no upper limit, however the lower limit concurred with chronological age. In the case of Skeleton 81 belonging to Elizabeth Bartlett, very few diagnostic elements were present in order to assign an age-range. Extensive antemortem tooth loss and complete obliteration at the observable cranial sutures suggested an older adult age bracket, most likely middle adult (*i.e.* 35 years of age) or above. Skeletons 74, 87 and 89 were all assigned to the 'old adult' age bracket. Osteological aging techniques are increasingly inaccurate with age, with available methods unable to age above 60 years of age. For this reason individuals aged beyond 60 years could not be assigned an upper age limit. The results highlight a high degree of accuracy with respect to osteological aging and sexing of the Littlemore assemblage and suggest that the age and sex estimates forwarded for the unnamed sample are, likewise, reliable.

***Table 3 Osteological Age-at-Death and Sex versus Biographical Age-at-Death and Sex in the named sample***

Skeleton Number	Name	Preservation	Osteological Age Range	Chronological Age-at-Death	Osteological Sex Estimate
73a	Edith Ellen Seaman	Poor	5-9 months	10 months	N/A
73b	Catherine Anne Seaman	Poor	12-18 months	22.8 months	N/A
74	William Cutcliffe	Excellent	>60 years	73 years	Male
81	Elizabeth Bartlett	Poor	>35 years	85 years	Female
87	Ann Bartlett	Excellent	>60 years	70 years	Female
85	Isaac Grubb	Excellent	40-50 years	36 years	Male
89	Mary Grubb	Good	>60 years	67 years	Female

*Metric Assessment  
Stature (Table 4)*

The stature of adult skeletons was assessed using complete femurs wherever possible. Potential adult stature is largely governed by genetics, however the actual height achieved by an individual once adulthood is reached can be greatly influenced by environmental factors experienced during the growth period (Larsen 1997, 13). As a result, below-average adult stature is a useful indicator of possible episodes of poor nutrition or other forms of physiological stress endured by an individual during development (Caffell and Clarke in press).

Stature estimates based on femoral length was possible for three males, resulting in an average of 165.7 cm (5'5"), and seven females giving a mean stature of 157.9 cm (5'2"). Both sexes fall below the average height for the period. Males were at the lower end of the range of means for their sex, whilst females were within the range for their sex when compared with data from ten post-medieval sites: 168-190 cm for males and 155-160 cm for females.

**Table 4 Stature comparison of Littlemore to other Post-Medieval assemblages**

Site	Males		Females		Source
	Mean (cm)	Range (cm)	Mean (cm)	Range (cm)	
Littlemore Chapel	168	168-169	158	147-161	
Priory Yard	168	157-175	155	145-163	Caffell and Clarke (in press)
St. Martin's Church	172	156-185	159	139-171	Brickley et al. 2006, 101.
St. Marylebone	170	154-182	159	145-169	Miles et al. 2008, 108.
West Butts	169	157-186	158	140-174	McKinley 2008, 64-67.
King's Lynn (Baptists)	169	153-181	160	152-166	Boston (in press)
St. Luke's, Islington	170	149-194	158	139-174	Boston et al. 2005, 135
Newcastle Infirmary	171	160-183	160	142-183	after Roberts and Cox, 2003
St George's, Bloomsbury	172	152-185	160	148-179	Boston et al. 2009, 109
Spitalfields, London	169	168-170	157	154-159	Molleson and Cox 1993, 24
Kingston-upon-Thames, London	169	155-190	160	140-175	Bashford and Sibun 2007, 134

Documentary sources of the period purport a noticeable difference in stature between the social classes (*i.e.* taller upper class individuals versus shorter lower class individuals). The sample size for Littlemore is small and may influence the significance of mean stature values, however overall it would seem that the majority of adults were at the shorter end of the norm for the period. Short stature amongst the Littlemore adults is perhaps to be expected however as it coincides with high rates of pathology in the subadult sample (see *Palaeopathological Analysis*). It seems likely, therefore, that periods of physiological stress in childhood experienced by those individuals reaching adulthood were significant, so much so that terminal stature was adversely affected. It is also interesting to note in light of the higher mortality rate of young females compared to males in the same age category that shorter women were more likely to give birth to stillborn or underweight babies, the latter of whom are in turn predisposed to malnutrition and therefore at greater risk of contracting infectious diseases (Caffell and Clarke 2010, 109).

*Metric Variation: Skeletal Indices*

Cranial and post-cranial measurements of the skeleton are taken as part of standard osteological analyses and can be useful indicators of biodistance and genetic closeness of groups of skeletons within cemetery assemblages (Larsen 1997). Cranial measurements were chosen in order to investigate genetic affiliation and variability within the sample whilst post-cranial measurements were used as a basis to interpret patterns of mechanical loading in the lower limbs in relation to occupation but also genetic affiliation. Indices were calculated as a means of expressing these morphological relationships between individuals. Mean values for the cranial and post-cranial indices calculated are outlined in Table 5. The most widespread system of categorization classifies the skull with a cranial index greater than 80 percent as brachycephalic (*i.e.* broad or round headed), less than 75 percent as dolichocephalic (*i.e.* narrow or long headed), and between 75 and 80 percent as mesocephalic (*i.e.* average or medium) (Schwartz 1995, 324).

A total of five cranial indices were calculated to determine skull shape. Cranial height and length measurements revealed a population consisting primarily of long-to-medium headed males and medium-headed females. Facial indices also showed that the majority of individuals for which an upper facial index could be calculated (66.7%; n=6/9) had 'slender' faces. Skeleton 58, a young adult female from the unnamed sample and Skeleton 85, identified as Isaac Grubb from the 'named sample' both had 'very narrow' faces. All individuals from the adult sample for which an orbital index could be calculated (n=9) had 'tall/ narrow eye' orbits (Schwartz 1995, 325) (Table 6). These results are comparable with the contemporary assemblage from Kingston-upon-Thames; a population characterised by low skulls and narrow faces typical of post-medieval populations in Britain (Bashford and Sibun 2007). Dimensions of mandibular ramus height and breadth were also within the normal range given for 19<sup>th</sup>-century populations (Larsen 1997). These measurements relate to parts of the mandible where powerful chewing muscles attach. The overall reduction in the size of mandibles over time in archaeological populations is thought to relate to the introduction of softer diets (Mays 1998, 80).

**Table 5 Cranial and Post-cranial Indices**

Cranial Indices	Males		Females	
	Mean	Range	Mean	Range
Cranial	76.46	73-76	77.15	77-81

Cranial height/length	68.17	68-71	69.66	64-74
Upper facial	56.16	52-66	56.98	54-64
Fronto-parietal	68.36	69-76	68.02	64-68
Orbital	97.69	96-98	99.09	93-108
Post-cranial Indices				
Robusticity (Femur)	77.32	70-85	76.59	66-86
Platymeric	87.59	76-99	86.66	77-95
Platycnemic	75.09	65-82	74.42	65-83

The degree of flattening of the femoral and tibial shafts was also explored. The results showed that the majority of adults had a low degree of medio-lateral flattening of the femoral shafts (as expressed by the platymeric index) and "moderately flattened" to "wide" tibial shafts (as expressed by the platycnemic index) (Schwartz 1995, 332). Various researchers have reported a temporal increase in the circularity of femoral and tibial shafts with the transition to sedentary lifeways (Larsen 1997). In general, populations with lower platymeric and platycnemic indices (*i.e.* flattened tibial and femoral shafts) tend to be more mechanically stressed than those with higher indices (*ibid*). Adults from the Littlemore assemblage had platymeric and platycnemic indices indicating moderately flattened to flattened lower longbone shafts. Long-bone mid-shaft measurements were used to determine the difference in levels of robusticity between individuals. Interestingly, robusticity based on femoral shaft diameter showed no significant difference between the sexes, with females on the whole averaging as only very slightly less "robust" than males. This lack of sexual dimorphism in relation to robusticity may be a reflection of the non-manual professional occupations recorded for much of Littlemore Chapel's male congregation.

#### *Non-metric Variation (Tables 6-8)*

Non-metric skeletal traits were recorded with a view to determining patterns of possible relatedness between adult individuals interred at the Littlemore burial ground, and more specifically between individuals from known familial groups in the named sample. Non-metric variation was most frequent in the cranium where all but one individual exhibited at least one cranial non-metric trait from the standard list. A total of 49 non-metric variations of the cranium were observed in the adult sample. The most frequently encountered cranial non-metric trait was the presence of a single, or in some cases, multiple orbital foramina; 18.4% (n=9) of observed cranial non-metric traits. Relatives Ann and Elizabeth Bartlett (Skeleton 81 and Skeleton 87 respectively) both shared this non-metric variant. The next most frequently



encountered non-metric trait was the presence of parietal and mastoid foramina each accounting for 12.2% of observed cranial non-metric traits and occurring in 40% (n=6/15) of the adult sample respectively.

Eleven adults (73.3%) had at least one post-cranial non-metric trait from the standard list. In total 44 cases of non-metric variation in the post-cranial skeleton were identified, the most common of which was the double facet of the talar articular surface of the calcaneus (n=7/15, CPR=47%). Interestingly this figure compares closely with that reported for the King's Lynn Baptist Assemblage (Boston 2005). In all but two cases (Skeleton 74 and Skeleton 89), the double facet form was expressed bilaterally. For the two individuals who exhibited unilateral expression of the double talar facet, both exhibited absence of the anterior talar facet along with two others. Taken together non-metric variation of the talar facet of the calcaneus was present in 7 individuals in total, or 47% of the adult sample. Only one definitive case of direct relatedness between individuals presenting with this trait were identified from the named sample, namely mother and son, Mary and Isaac Grubb (Skeleton 85 and Skeleton 89 respectively) who shared the same burial plot.

**Table 6 Summary Cranial Non-Metric Trait Data for Adult Sample**

Skeleton No	Supra-orbital foramen	Pre-condylar facet	Foramen spinosum (incomplete)	Posterior condylar canal (double)	Condylar facet (double)	Mastoid foramen	Anterior ethmoid foramen	Posterior ethmoid foramen	Anterior condylar canal (double)
58	1	0	0	1	0	0	0	0	1
59	9	0	0	0	0	9	9	9	0
60	1	0	9	0	0	1	9	9	0
62	1	0	1	1	0	1	0	0	1
70	1	9	9	0	0	0	9	9	9
72	1	9	9	0	0	1	9	9	0
74	0	0	9	0	0	0	1	1	9
76	0	0	0	0	0	0	9	9	0
81	1	9	9	9	9	0	9	9	9
83	0	9	9	9	9	1	0	0	9
85	1	0	0	0	0	0	1	1	0
87	1	0	0	0	0	1	0	0	1
89	1	0	0	0	1	1	9	9	0
90	0	1	0	0	0	0	9	9	1
91	0	9	0	0	0	0	0	0	1



83	0	9	0	9	0	9	0	0	9	9	0	0	0	9	0	0	0	0
85	0	0	0	0	0	0	0	0	0	0	9	9	0	0	0	0	1	1
87	0	0	0	0	0	0	0	0	1	1	0	0	0	0	0	0	0	
89	0	0	0	0	0	0	9	9	9	9	0	9	0	9	0	1	1	0
90	1	1	0	0	0	0	0	0	0	0	0	0	0	0	0	0	1	1
91	0	0	0	0	0	0	0	0	1	1	0	0	0	0	0	0	0	0

KEY: 0= trait absent, 1= trait present, 9= trait unobservable, L=left side, R= right side

### *Non-metric traits of Dentition*

Although not systematically recorded due to time constraints during analysis, dental non-metric traits were noted when apparent. Just one case of a dental non-metric trait was encountered, namely bilateral Carabelli’s cusps on the mesiopalatal aspect of the upper first molars of Skeleton 68; a subadult from the unnamed sample. Carabelli’s cusp presents as an additional cusp most commonly on the first molar and is seen in some form in 75-85% of Europeans (Hillson 1996). Despite being a known heritable feature between related individuals, this trait was not identified on any other individual from the Littlemore sample. High rates of antemortem tooth loss may well have precluded identification of this trait however.

The general picture of non-metric variation in the Littlemore assemblage is one of frequently shared traits between the skeletons, even those not directly associated with one another according to their position in the graveyard. Considering the strictly enforced Particular Baptist policy of endogamy (i.e. marriage within one’s own church family) then this pattern of shared traits may be an indication of a close level of relatedness between individuals interred at the Baptist Chapel.

### *Palaeopathological Analysis*

Pathological lesions were observed on a total of 20 individuals (CPR 67%) including all 15 adults and a total of 5 subadults. The high prevalence rate of disease seen in the Littlemore assemblage is not unexpected and correlates with skeletal assemblages of the period (Boston 2005; Brickley et al. 2006; Bashford and Sibun 2007; Powers 2010; Caffell and Clarke 2010). Migration of the poor to urban areas created a large impoverished group of lower classes whose access to adequate housing, sanitation and medical treatment was severely curtailed in comparison to their middle-class counterparts. This trend of immigration could be seen at the

parish of Littlemore when at the turn of the 19th-century immigrant workers were attracted to settle near the village on account of the growing demand for casual labour (British History Online). At the end of the 19th-century immigrant workers constituted a distinct group whose presence was not welcomed by local inhabitants. Contemporary reports on immigrant labourers in the area claimed that many of the men were 'idle' whilst the women supplemented their wages by doing laundry (ibid.). Despite the steady influx of immigrants into the village, by the end of the 19th-century the parish of Littlemore had largely retained its rural character with an economy heavily reliant on agriculture (ibid).

During the 19th century the picture of 'disgraceful' sanitation and housing conditions in Oxford (Oxford Herald cited by BHOL) mirrored that of the vast majority of urban centres throughout Britain. Mid 19th-century census figures for the area highlighted a greater than average annual mortality rate when compared to other centres of population in the country (ibid.). As a rural village on the outskirts of Oxford, Littlemore was unlikely to have experienced the heavy demands on public sanitation as those in Oxford city. Nevertheless, many of Littlemore's inhabitants would have resided in poorly-ventilated thatched cottages typical of the Victorian British countryside, most likely with shared privy facilities and no running water. Water sanitation in Oxford and its environs was a major public concern during the period prompting threats to open an independent water company due to lack of improvements by the local corporation (British History On-Line). The first major outbreak of cholera in Oxford occurred in 1832, resulting in a reported 194 cases of the disease and a 50% mortality rate (BHOL). An even more virulent outbreak (though lasting a shorter period of weeks) occurred in 1853 this time with a 59% mortality rate (ibid). According to the London Bills of Mortality other common causes of death during the period included convulsions (principally in teething infants), pulmonary tuberculosis, small pox and an array of other fevers (Cox 1996, 74).

It is unlikely that many members of the Littlemore Baptist congregation were impoverished during the period represented by the assemblage, and so it is perhaps not surprising that many of the pathological conditions encountered in the assemblage are linked to increasing age. Subadult health amongst the Littlemore Baptists was very poor however, with one in three infants exhibiting signs of gross nutritional deficiencies in one form or another (see Subadult: Metabolic Disease). It is beyond the scope of this report to describe in detail each of the pathological conditions observed, however, comparisons are drawn wherever possible to evidence from other skeletal assemblages of the period and contemporary documentary accounts of the health of the middle-classes in the latter half of the 19th century. Detailed descriptions of all pathological lesions observed are contained in the archive. Adult and

subadult health is considered separately for the purposes of this report so as to negate possibly misleading disparities relating to true prevalence rates based on bone counts.

A particularly interesting adult skeleton from the named sample, worthy of note at this stage, was that of Skeleton 74, identified as retired Baptist minister William Cutcliffe aged 73 years at his time of death. This individual exhibited multiple pathological lesions throughout his body and appears to have suffered from numerous illnesses that manifested on his skeleton, including cancer and a seronegative form of arthritis in his right hand and both feet. During excavation of this burial the remains of two possible medical devices incorporating leather straps and fabric-covered copper alloy pads were found in association with the knee area of his skeleton (see Clough below). During osteoarchaeological analysis pathological changes were not noted on the knees, however, so it is possible that any affliction in this area of his body was tissue-related leaving no skeletal mark. Due to the high levels of pathology seen on his skeleton, William Cutcliffe (Skeleton 74) is frequently referred to in the subsequent Palaeopathological Analysis sections of this report.

### *Dental Health*

In general, dental health during the Victorian period was extremely poor, the cause often being attributed by researchers to the soft cariogenic diet, and inadequate oral hygiene and dental treatment of the period (Roberts and Cox 2003). Increasing availability of sugar to the masses resulted in unprecedented levels of sugar consumption and, coupled with the wider availability of refined carbohydrates (particular bread made from finely-milled flour), contributed greatly towards the appalling dental health of individuals across social-class divides (ibid). The most common dental complaint of the period was caries (i.e. 'dental decay'), however calculus (i.e. tartar), periodontal disease, antemortem tooth loss and enamel hypoplasia were all seen in the dentitions of the Littlemore skeletal assemblage, as they are in many contemporary skeletal assemblages (e.g. King's Lynn Quakers and Baptists; Kingston-upon-Thames Quakers; St. Luke's, Illington; Priory Yard Baptists). It has been suggested that the low levels of dental wear seen in post-medieval skeletal assemblages contributed to high levels of caries by increasing the likelihood of bacterial colonies in caries-prone areas of the tooth such as the grooves between cusps in premolars and molars (Larsen 1997).

The entire adult sample (n=15) and all but one individual from the subadult sample (n=14) had observable dentitions, defined by the presence of teeth and/or one or both of the jaws. Adult dentitions comprised a total of 138 teeth and 431 tooth sockets, whilst subadult dentitions (including permanent tooth crowns) totalled 211 teeth and 99 sockets. True

prevalence rates (TPR) for each of the categories of dental disease observed in the skeletal samples were calculated based on the number of observable sockets and/or tooth crowns.

#### Caries (Figure 4)

Caries, colloquially termed 'dental decay' is a disease process which involves focal destruction of the tooth enamel surface, underlying dentine and cementum of teeth. The disease process is caused by the action of acid-producing bacteria that has colonised dental plaque adhering to the affected teeth (Hillson 1996). An association of high levels of sugar in the diet with acidogenic bacteria is a well-established cause of cavitations in dental tissues as a result of caries (Lukacs 1989). Lesions can occur anywhere on the tooth crown or root. In rarer cases, the condition can become rampant with gross lesions and prolific destruction of the majority of tooth crowns. One such case was identified in the dentition of Skeleton 90, a young adult female from the unnamed sample. This individual exhibited extensive interstitial caries, most severe on the molars, with considerable destruction of tooth crowns and probable secondary antemortem tooth loss of five of her teeth as a result of the condition. An externally draining abscess at the apex of the upper left lateral incisor had associated reactive bone deposits around the circumference of lesion. The condition almost certainly caused a great degree of discomfort in life.

In general the prevalence rate of caries in the Littlemore assemblage is an approximation as it is not known how many of the teeth lost ante/post-mortem may have been affected by carious lesions. Considering the high rate of antemortem tooth loss in the adult assemblage (see Antemortem Tooth Loss) this caveat is of particular importance.

A total of 56 carious lesions were observed on the 138 permanent teeth from the adult sample whilst just 7 teeth from the subadult sample had carious lesions. The true prevalence rate of caries in the adult sample was calculated as 40%, with a crude prevalence rate of 83% of individuals with observable teeth (n=10/12) affected by caries on one or more teeth. These rates exceed those reported from ten broadly comparable sites (Table 9) and the 43% caries rate calculated by Roberts and Cox (2003) based on skeletal assemblages from the period. The rate of caries at Littlemore exceeded even the exceptionally high adult CPR of 75% reported for the Baptists from Priory Yard (Caffell and Clarke 2010.). The crude prevalence rate calculation showed little difference between the sexes with respect to caries susceptibility; 88% (n=7/8) of females and 75% (n=3/4) of males with observable teeth had one or more carious lesion. Females suffered from slightly higher numbers of affected teeth

per person than males with a mean of 7.3 teeth affected compared with a mean of 7 teeth in the male sample.

The TPR for caries in subadult dentitions was 3% representing a significant short-fall in comparison to the adult TPR. This figure is also considerably lower than that reported for the General Baptists of Priory Yard, Norwich where 25% of deciduous teeth were affected by caries to some degree (Caffell and Clarke 2010). Caffell and Clarke (ibid) attributed the pattern of caries distribution in subadult dentition from Priory Yard to bottle-feeding with sweetened milk or possibly the sucking on sweetened comforters. In total just two subadults at Littlemore, both from the unnamed sample (Skeleton 77 and Skeleton 88), exhibited carious lesions. In both cases, however, the lesions were multiple resulting in secondary antemortem tooth loss of the lower first molars in the case of Skeleton 77. It is also worth noting that Skeleton 77 and Skeleton 88 represent the only two subadults who lived past 2 years of age in the subadult sample. This, coupled with the extraordinarily high levels of caries and probable secondary antemortem tooth loss as a result of caries in the adult samples, suggests a positive correlation between increasing age and caries prevalence. The drop-off of caries prevalence rates seen in the 'old adult' age category is largely as a result of high rates of antemortem tooth loss in this portion of the adult sample (and hence a reduction in the number of teeth present in order to observe carious lesions).

#### Antemortem Tooth Loss

Antemortem tooth loss (i.e. the loss of teeth prior to death) can be the result of a multitude of factors including (several) disease processes, trauma or purposeful dental extraction. Calculus deposits can irritate the dental tissues leading to weakening of the periodontal ligament and resorption of the alveolar bone (periodontal disease) ultimately resulting in loss of the tooth. In addition, periapical abscesses forming as a result of gross carious lesions at the crown and exposure of the underlying pulp-cavity and/or excessive attrition can lead to death of the tooth root and loss of the tooth. Long-standing antemortem tooth loss, defined for the purposes of this report as tooth loss occurring more than 12 months prior to death, is easily recognisable in the jaws due to the resulting resorption of the tooth socket and alveolar process at the affected tooth site. Short-term antemortem tooth loss can be identified by observation of the level of resorption of the affected tooth socket. If the socket morphology is largely retained but some level of resorption has occurred then tooth loss most likely occurred less than 12 months before death. In general, antemortem tooth loss is regarded as a degenerative disease process (Hillson 1996). However, factors such as the development of dental intervention techniques in the 19th century and the common practice of dental extraction (Roberts and Cox

2003) as a preventative measure, may also have contributed to patterns of antemortem tooth loss.

**Figure 4 % Mean TPR Caries according to Age-at-Death**

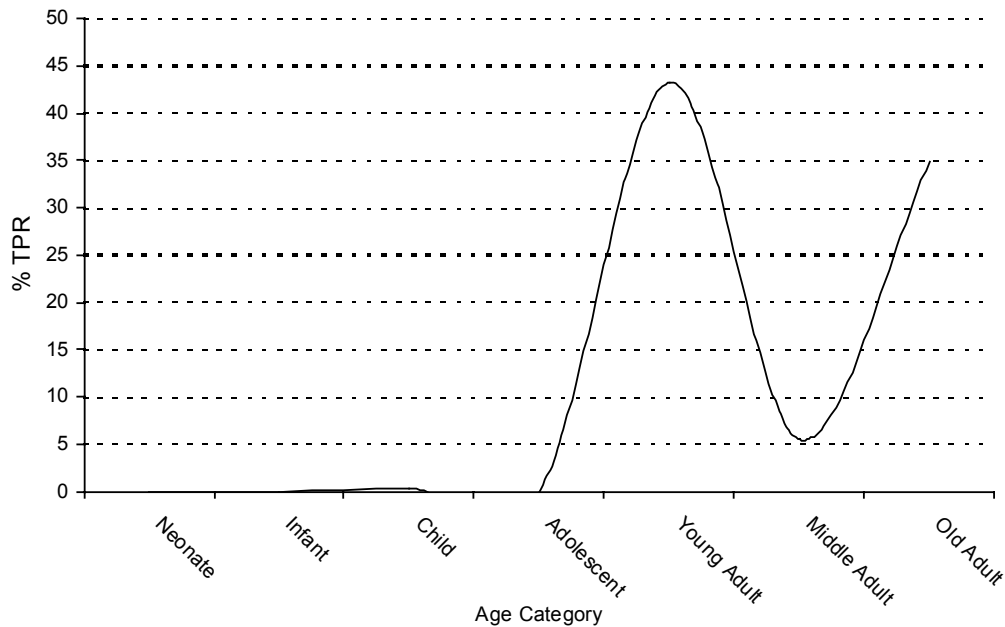

All five males and a total of 9 females exhibited antemortem tooth loss giving an overall CPR of 93% for this condition in the adult assemblage. The true prevalence rate for antemortem tooth loss was calculated as 57% from a total of 247 teeth from 431 sockets. Over half of the adults with observable jaws (53%; n=8/15) exhibited mixed timing antemortem tooth loss, with the remaining seven adults exhibiting long-standing tooth loss. A pattern of preferential loss of the molars over other teeth was clearly evident. Skeleton 72, an old adult male from the unnamed sample, and Skeleton 89, an old adult female named as Mary Grubbs with an age-at-death of 67 years, were both edentulous. All 14 observable sockets belonging to Skeleton 81, Elizabeth Bartlett aged 85 years at death, showed complete long-term resorption. It is likely that this individual was also edentulous, however without the missing socket sites this is impossible to determine with certainty.

The antemortem tooth loss rates seen in the Littlemore adult sample are exceptionally high even when compared to broadly contemporary assemblages such as the Baptists from King’s Lynn, who had a TPR of 33.2% (Boston 2005). A more comparable TPR of 54% was reported however for the Quakers at King’s Lynn (*ibid*). Antemortem tooth loss crude prevalence rates of 89% and 85%, again close to but not as high as the Littlemore sample, were reported for the Quaker assemblage from Kingston-upon-Thames (Bashford and Sibun



2009) and the General Baptist assemblage of Priory Yard, Norwich (Caffell and Clarke 2010) respectively. The high rates of antemortem tooth loss seen in the Littlemore adult sample are likely to be a reflection of the old age of the majority of affected individuals (Figure 5).

One subadult (Skeleton 77), from the unnamed sample, osteologically aged as 11-12 years at the time of death exhibited bilateral antemortem tooth loss of the mandibular first permanent molars in association with relatively widespread caries (see *Caries* above). Considering the first molars begin to erupt at approximately 6 years of age and are not fully erupted until approximately 12 years of age, the timing of antemortem tooth loss would seem to suggest purposeful extraction rather than natural tooth death. The degree of alveolar resorption in both tooth sockets was almost identical with both teeth lost less than 12 months prior to death. This apparent close timing of the loss of both teeth would also appear to support the supposition of dental extraction.

**Figure 5 % Mean TPR Antemortem Tooth Loss according to Age-at-Death**

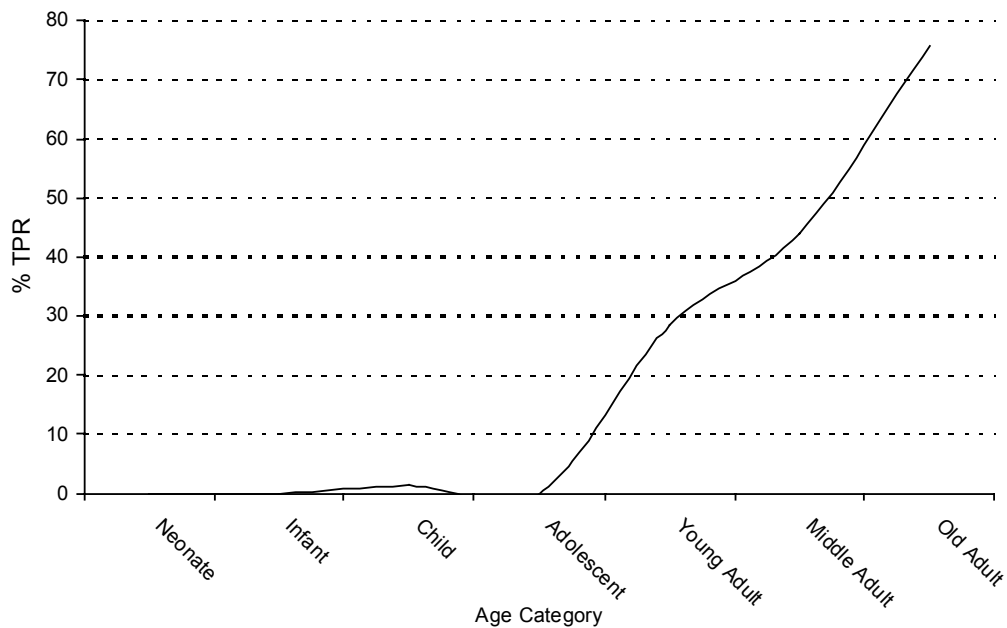

#### Periodontal Disease

Periodontal disease is a pathological process brought on by chronic inflammation of the soft tissues of the mouth, specifically the gums (i.e. gingivitis), periodontal ligament and alveolar

bone. Multiple factors may predispose an individual to periodontal disease, including genetics, diet and inadequate levels of oral hygiene. A widely reported cause of the condition, however, is the accumulation of calculus in and around the tooth sockets causing irritation and leading to inflammation of the gums and periodontal ligament which, along with the alveolar bone, helps to hold the teeth in place during life. Retraction of the gums and alveolar bone is a secondary outcome followed by tooth loss. Periodontal disease can occur focally at the site of a single tooth, but more commonly in elderly individuals across the entire dental arcade (termed "horizontal periodontitis") (Hillson 1996).

There is a positive correlation between increasing age and prevalence of periodontal disease in both modern and archaeological populations. There were no cases of periodontal disease in the subadult assemblage, so the prevalence rate for the condition reported here refers to the adult sample only. Periodontal disease was recorded using the Ogden (2005) method which classifies the morphological appearance of the alveolar process into one of 5 stages. Ogden (ibid.) purports that observations of the amount of root exposure alone, as per the commonly-employed Brothwell (1981) method, may lead to inaccuracies in reported prevalence rates of the condition since root exposure may be caused by a variety of factors not exclusive to periodontal disease, such as excess attrition. Nevertheless for future comparative purposes an overall indication of the severity of periodontal disease in the Littlemore adult assemblage, (namely "slight", "medium" or "considerable"), in line with the Brothwell (1981) method was recorded as supplementary to the Ogden method data and may be found in the archive.

Periodontal disease was present at 17% (n=72/431) of tooth sockets. It affected 47% of individuals (n=7/15) from the adult assemblage. The crude prevalence rate is notably higher than those reported at contemporary sites such as St Luke's, Islington (Boston et al. 2005) where just 20% of the individuals showed signs of the disease. A comparable CPR is reported, however, for the Bow Baptists (Powers 2010) where 41% of the individuals had periodontal disease. The high CPR at Littlemore is even more significant when the overall high levels of long-standing alveolar bone resorption (making the morphology of the alveolar process unobservable) is taken into account. The majority of affected individuals (86%; n=6/7) exhibited a "moderate" to "considerable" degree of severity. A predilection for males was also apparent from a comparison of crude prevalence rates between the sexes, with males 1.5 times more likely to exhibit the condition. Of those individuals with periodontal disease, an average of 10.2 tooth sites per person was affected. In general it would appear that "horizontal" as opposed to "vertical" periodontal disease was present in the Littlemore adult sample indicating chronic widespread gingivitis in the dentition of the majority of adult individuals.

One notable case of periodontal disease was observed in the maxillary dentition of Skeleton 90, a young adult female from the unnamed sample. Here, considerable porosity at the superior and anterior aspects of the alveolar process had resulted in exposure of the roots of the anterior teeth and an abnormally concave appearance to the maxilla in profile. Early stage leprosy has been reported as a possible cause of maxillary alveolar bone resorption (Roberts and Manchester 1995), but the lack of remodelling of the nasal aperture and other leprotic changes in the case of Skeleton 90, makes this diagnosis unlikely. This same individual exhibited rampant caries (see above), which may be linked to the extent of periodontitis.

#### Dental Enamel Hypoplasia (DEH)

Dental enamel hypoplasia (DEH) presents as enamel defects of line, groove or pitted form on the buccal/labial surface of the affected tooth crowns. The condition is thought to reflect disruptions in enamel development in the first 6-7 years of life as a result of episodes of malnutrition or illness (Goodman and Rose 1991, Hillson 1996). These episodes must last at least three weeks to create a macroscopically observable defect in the enamel surface (ibid). Since enamel does not remodel in life and preserves better than any other hard tissue, defects in its structure provide an excellent source of information on stress and morbidity in past populations (Larsen 1997). DEH was recorded in both adult and non-adult dentition via identification of the disease's characteristic enamel defects of lines, pits or grooves on the tooth crown surface. For each affected tooth the number of defects was recorded to aid interpretation of the number of episodes of physiological stress suffered by the affected individual in early childhood. Multiple episodes of physiological stress were evident from this analysis. Fifty percent of adults with teeth (n=6/12) and 31% of subadults with teeth (4/13) found to have suffered at least one episode of significant illness/ malnutrition sufficient in time to result in an enamel defect on the tooth crown surface.

#### ***Figure 6 % Mean TPR Periodontal Disease according to Age-at-Death***



Of the 109 observable teeth from the adult sample (*i.e.* those teeth where crowns were sufficiently intact to observe enamel defects), 22% were affected by DEH. A clear predilection for defects in the anterior teeth was noted, following the pattern seen in most archaeological populations (Larsen 1997). There was no significant difference between the sexes in terms of susceptibility to DEH. The %TPR of dental enamel hypoplasia in the Littlemore sample is very closely comparable to the Priory Yard Baptist assemblage (Caffell and Clarke 2010) but considerably lower than Baptists from King’s Lynn (Boston 2005).

Three of the 6 adults with the condition showed only faint lines or a single line on each of the affected teeth possibly indicating less severe or shorter periods of physiological stress in childhood (although line depth or severity is not always related to insult severity; Hillson 2005). Skeleton 70, a young adult female from the unnamed sample, and Skeleton 85 belonging to Isaac Grubb aged 36 at his time of death, both exhibited multiple lines of enamel defects. In the case of Isaac Grubb (Skeleton 85) this condition coincided with an area of well-healed bone inflammation on his cranial vault. Although the timing of this insult could not be placed specifically during his childhood, the long-standing appearance of the lesion is further evidence of a period of physiological stress endured by him in life, which had resolved itself prior to death.

Skeleton 58, that of a young adult female, exhibited the most severe enamel defects of the adult sample with 40% of her teeth affected. Generalised poor development of the tooth crowns, particularly the molar crowns and most notably at the lower left first and second

molars, manifested as grossly deformed cuspal architecture characterised by multiple cusplets. Enamel defects of this type of morphology have been reported in subadults from the post-medieval assemblage of Broadgate, London (Ogden *et al.* 2007). Here, researchers suggested a new category of enamel hypoplasia termed "cuspal enamel hypoplasia" based on gross morphology and scanning electron microscopy of the affected tooth crowns. The confinement of hypoplastic changes in the molars of Skeleton 58 to the occlusal surface of the tooth indicates that the period of physiological stress causing these gross pathological changes must have occurred in the first two years of life (Moorrees *et al.* 1963, Smith 1991). The timing of this period(s) of physiological stress is in-line with mortality figures for the Littlemore assemblage where subadult deaths peaked from around the time of birth to 2 years of age (see above).

Of the 13 subadults with observable teeth, just one individual (Skeleton 73b) showed clear evidence of hypoplastic defects of the tooth crowns giving a crude prevalence rate of 8% (n=1/13) for the subadult sample overall. Skeleton 73b represented the skeletal remains of Catherine Anne Seaman who was recorded as being 22.8 months old at her time of death. In this case the enamel defects were remarkably similar in morphology to those seen on the molars of adult female Skeleton 58. The majority of observable deciduous teeth were unaffected with the exception of the upper second deciduous molars whilst multiple enamel defects were noted on all the permanent tooth crowns. The timing of enamel defects in this individual appears to have begun at around the time of birth and continued, either intermittently or consistently, up to the time of death. These lesions coincide with gross skeletal lesions on the cranial vault which are indicative of a systemic metabolic disorder.

#### Calculus

Calculus, or colloquially termed tartar, results from the mineralization of microorganisms that have become embedded in a matrix of protein and saliva adhering to the teeth (Hillson 1996). Calculus formation has been linked to diets high in protein and/or carbohydrates. High levels of calculus in archaeological populations may therefore be an indication of diet but also of oral hygiene practices. Calculus can come in two forms; supra and subgingival, meaning above or below the gumline respectively. The severity and distribution of calculus deposits was recorded for each of the affected teeth, however this level of detail is not within the scope of this report and so only crude and true prevalence rates are reported here. Calculus did not occur in the subadult sample. For this reason prevalence rates reported here relate to the adult sample alone.

Twelve adults had at least one tooth or tooth root observable for calculus. Tooth roots were included in the calculation of prevalence rates to account for possible cases of subgingival calculus. Of these 12 adults, 9 had one or more teeth with calculus deposits giving a CPR of 75%. Fifty-three percent (n=73/138) of observable teeth were affected, a figure representing the TPR of calculus in the adult sample. On average 6.1 (n=73/12) teeth per individual with observable teeth were affected.

The true prevalence rate of calculus in the Littlemore adult assemblage is comparable with the rates reported for St. Luke's, Islington (Boston *et al.* 2005), but considerably lower than rates given for non-conformist assemblages of Priory Yard, Norwich (Caffell and Clarke *in press*) and King's Lynn (Boston *in press*) (Table 9).

**Figure 7 % Mean TPR Dental Enamel Hypoplasia according to Age-at-Death**



Comparison of mean true prevalence rates between the sexes showed males had two-times more teeth affected than females with a TPR of 65% compared to a TPR of 31% in the female sample. Given the small sample size it is problematic to attribute significance to these figures, however the large disparity in rates of calculus between the sexes could be an indication of males consuming higher levels of protein/ carbohydrates in their diet than females making them more susceptible to calculus build-up. In addition, it could be due to differences in the levels of oral hygiene between men and women. In the majority of cases where calculus was present the deposits were slight. This may suggest that some form of oral hygiene was attempted. There did not appear, however, to be any obvious signs of regular use of abrasive

dentifrices or tooth powders which would have been available at the time for the purpose of cleaning one's teeth. The TPR of calculus according to age-at-death showed a distinct rise into old age (Figure 8).

#### Periapical Cavities: Abscesses, Granulomas and Cysts

Periapical cavities are identified at the apex of tooth sockets by the presence of a hole/ sinus in the wall of the jaw. An abscess may develop as a result pus-forming bacteria entering the pulp-cavity, commonly via dental caries, excessive attrition, or trauma to the tooth crown, and tracking down the root to the apex. As pus accumulates within the dental socket pressure increases precipitating the formation of a small hole or sinus to allow the pus to drain away from the site of infection and into the overlying soft tissue (*i.e.* gums) (Roberts and Manchester 1995). Where this process is long-standing bone inflammation may occur resulting in periostitis around the circumference and adjacent bone of the lesion. Periapical abscesses are the expression of the acute form of this condition and may be identified by their sharp edges indicating that little or no remodelling of bone had occurred. Periapical granulomas and periodontal cysts occur in chronic cases where the bone has time to remodel in response to the destruction caused by the periapical inflammation (Dias and Tayles 1997). Periodontal disease, caries and calculus are all predisposing factors to the development of dental abscesses in the dentition of an individual.

Five adults exhibited one or more periapical cavities in association with teeth either present, lost post-mortem or lost antemortem giving a crude prevalence rate of 17% (n=5/30) for the entire assemblage and 33% (n=5/15) for the adult sample. There was no case of periapical cavities occurring in subadult dentition, most likely as a reflection of the low rates of caries and absence of periodontal disease and calculus in this proportion of the assemblage. In addition, the fragmentary condition of many of the subadult jaws coupled with the preponderance of young infants with unerupted teeth in the subadult sample may have precluded identification of periapical cavities to a large degree.

Of the total number of adult tooth sites present for analysis, 11 had associated periapical cavities giving a TPR of 2.6% (n=11/431). An average of 6.1 tooth sites (n=73/12) per adult exhibited a periapical cavity. These rates are closely comparable to reports from broadly contemporary assemblages, although significantly higher than figures from King's Lynn Quaker assemblage (Boston *in press*) (Table 9).

All five of the individuals who exhibited periapical cavities were females. It is unclear whether this may be indicative of a true pattern of a greater susceptibility in females to periapical inflammation or as a function of the small sample size. As caries rates were greater in females compared to males this would suggest a link between this condition and the development of periapical cavities. In the case of females Skeleton 70 and Skeleton 90, both from the unnamed sample, associated reactive bone deposits were observable around the circumference of the sinus lesions. In both cases the reactive deposits were composed of woven bone indicating that they had not healed prior to death. The periapical cavity occurred in the mandible of Skeleton 70 and the reactive bone deposits, in this case, tracked from the apex of the right second premolar anteriorly into the right mental foramen leading to the mandibular canal. The mandibular canal houses the alveolar nerve, which supplies the lower teeth with sensory branches that form into the inferior dental plexus and give off small gingival and dental nerves to the teeth. Anteriorly, the nerve gives off the mental nerve at about the level of the mandibular second premolars, which in turn exits the mandible via the mental foramen, supplying sensory branches to the chin and lower lip. Inflammatory bony changes in this region, as seen in Skeleton 70, may well have resulted in aggravation of these sensory nerves possibly resulting in pain and discomfort in the jaw.

#### Activity-related Dental Wear and Staining

Postmedieval skeletal assemblages typically show very low levels of dental wear as a reflection of the soft diet of the period (see above). This compounded by the high frequency of antemortem tooth loss of adult dentition (particularly the molars precluded scoring dental attrition in the Littlemore assemblage. Nevertheless, cases of unusual dental wear patterns considered indicative of occupational or habitual practices involving the teeth were systematically recorded and are discussed briefly here.

#### ***Figure 8 % Mean TPR Calculus according to Age-at-Death***



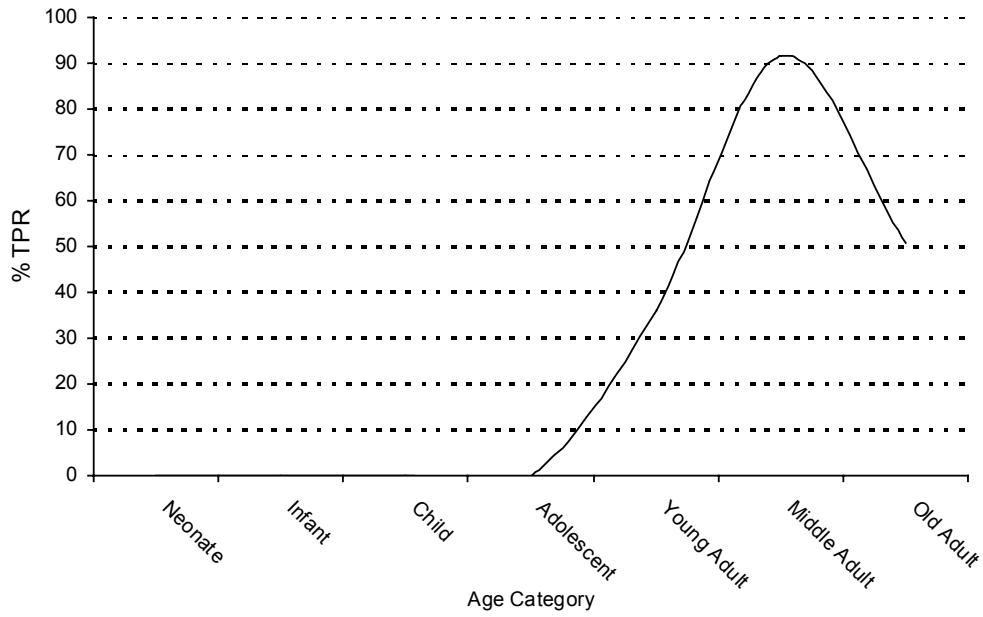

**Table 9 Summary of % TPR dental pathology in adults from five post-medieval sites in England compared with Littlemore Assemblage**

Skeleton assemblages	Ante-mortem tooth loss	Dental abscesses	Calculus	Caries	DEH	Dental Fillings
Littlemore Baptists	57% (247/431)	2.5% (11/431)	52.9% (73/138)	40.5% (56/138)	22% (24/109)	0%
Priory Yard Baptists	55.9% (496/888)	1.8% (16/888)	82.8% (227/274)	23.0% (63/274)	22.6% (62/274)	0%
Kings Lynn Baptists	33.2% (135/407)	1.47% (6/407)	85.4% (181/212)	18.7% (39/212)	60.7% (119/196)	0.47% (1/212)
Kings Lynn Quakers	53.82% (169/314)	0.32% (1/314)	74.2% (98/132)	36.0% (41/114)	41.84% (41/98)	0%
St Luke's, Islington (named)	35.35% (1726/4883)	1.78% (87/4883)	46.33% (1042/2249)	9.74% (219/2249)	10.27% (231/2249)	0.27% (6/2249)
Newcastle Infirmary, Newcastle	19.3% (604/3123)	0.9% (29/3123)	55.85% (718/1287)	11% (146/1327)	17% (219/1287)	0.0%

Skeleton 62 and Skeleton 91, both old adult females from the unnamed sample, shared an unusual dental wear pattern affecting the lingual surface (*i.e.* the surface facing the tongue) of the upper right and upper left central incisors respectively (Plate I). In both cases the wear occurred approx half-way up from the cemento-enamel junction where excessive abrasion had removed the enamel layer to reveal the dentine beneath thereby giving the normally flat surface of the incisor a "stepped-in" appearance in profile. In the case of Skeleton 62 the adjacent left central incisor had been lost post-mortem, whilst the adjacent upper right central incisor of Skeleton 91 was unaffected. It is unclear as to what may have caused this unusual dental wear pattern and the author was unable to find parallels reported in dentitions of other postmedieval assemblages. From the morphology of the wear pattern it would appear that these individuals had engaged in an activity, which involved gliding some kind of material, possibly thread, across the lingual surface of the upper incisor(s). During the Victorian period industrialisation of the textile industry meant an increase in women entering the workforce. It was not considered appropriate for middle-class women to enter the public workforce. Instead, dress-making from home was a popular means of supplementing the household income, and may well have involved the use of one's teeth as a "third hand" perhaps for cutting thread.

Skeleton 60, a middle adult male from the "unnamed sample" and Skeleton 85, identified as Isaac Grubb from the named sample, both exhibited dental wear consistent with pipe smoking. These areas of wear are termed "pipe facets" in the osteoarchaeological literature. They may be identified by dental wear occurring on adjacent occlusal surfaces usually of the anterior teeth, which together form a shallow concave/ semi-circular opening once the upper and lower teeth are in occlusion. In both cases the pipe facets were on the right side of the dentition, between the upper and lower canines and also involving the upper lateral incisor in the case of Skeleton 60. Pipe-smoking was a popular activity amongst men both of the working classes and upper classes in Victorian Britain and evidence of this activity in the form of pipe-facets is commonly reported in skeletal assemblages dating to this period (Powers 2010).

Further possible evidence of pipe-smoking was noted on the teeth of Skeleton 74, identified as retired Baptist Minister William Cutcliffe, who exhibited considerable levels of dark-brown staining on the labial crown surfaces of the upper central incisors and circumferentially at the cemento-enamel junctions of the upper canines, lower left canine and upper right lateral

incisor. There was no associated pipe-facet on the teeth of this individual, however extensive antemortem tooth loss may have precluded identification.

#### Dental Overcrowding and Malocclusion

Overcrowding of the dentition is amongst the most common oral irregularities reported in modern clinical settings and is most frequently observed at the incisors and canines. It is believed to stem from a variety of factors including genetic predisposition (Hillson 1996). Overcrowding commonly results in the rotation and/or displacement of teeth from their normal position in the jaw. Irregularities in tooth position due to overcrowding are normally a function of small jaw size, and as a result commonly occur alongside tooth impaction in the same individual, particularly of the third molars (*i.e.* the last teeth to develop and erupt in the jaw). Overcrowding and degree of individual tooth rotation was recorded for each adult individual. Subadult dentitions were not assessed for dental position irregularities as final permanent tooth position could not be determined.

Overcrowding of the mandibular anterior dentition was identified in two individuals, Skeleton 58 and Skeleton 90, both of whom were young adult females from the unnamed sample, giving a crude prevalence rate of 16% for this type of dental irregularity. In both cases overcrowding had resulted in rotation and displacement of a number of anterior teeth. A third individual, Skeleton 76, a young adult male also from the unnamed sample, exhibited slight distal rotation of the lower left canine.

Malocclusion is a misalignment of teeth and/or incorrect relation between the teeth of the two dental arcades when in occlusion. Most individuals exhibit a minor degree of malocclusion with little or no adverse affects in life. This type of dental irregularity may be due to trauma during development that affects the permanent tooth bud, ectopic eruption of teeth, supernumerary teeth, and early loss of the primary tooth (Klein 1952). Just two adults, Skeleton 58 and Skeleton 90, had skulls and jaws sufficiently intact to observe occlusion. Whilst the latter individual exhibited a natural overbite within normal ranges (*i.e.* between 3-5 mm or approximately 20-30%; Okeson 2008), Skeleton 58 had an overjet where the anterior teeth protruded outwards thus resulting in an open bite. This type of dental disorder has been linked to habitual thumb-sucking and prolonged or incorrect use of a pacifier/ feeding bottle in childhood and in some cases temporomandibular joint disease, where sufferers commonly protrude their tongue forward in the mouth to ease discomfort.

#### Dental Anomalies (Table 10)

Human dentition can exhibit a range of dental anomalies that include tooth impaction (*i.e.* failure of a tooth to erupt correctly), supernumerary teeth, retention of deciduous teeth into adulthood and tooth agenesis (Hillson 1996). Two adults from the unnamed sample, Skeleton 83 (an old adult female) and Skeleton 90 (a young adult female) exhibited possible congenital absence of the lower third molars and lower right third molar respectively. In the absence of dental X-rays, however, this diagnosis cannot be confirmed. Skeleton 87 from the named sample, identified as Ann Bartlett (aged 70 at her time of death) had an impacted lower left third molar, the only tooth in her lower dental arcade not lost antemortem. Due to the high rate of antemortem tooth loss in the adult sample, prevalence rates calculations to determine the frequencies of dental anomalies were not considered useful.

**Table 10 Dental Anomalies in the Adult Sample**

named Sample			
Skeleton No	Name	Chronological Age-at-Death (years)	Dental Anomalies Description
74	William Cutcliffe	73	Discreet accessory tubercle at lingual crown surface of the upper right third molar
87	Ann Bartlett	70	Impacted lower left third molar
unnamed Sample			
Skeleton No	Sex	Osteological Age-at-Death (years)	
58		21-38	Small diastema between upper central incisors. Enamel pearl at distal-lingual aspect of cemento-enamel-junction of upper left third molar. Upper left third molar has reduced cusp at distal border compared to upper right third molar. Accessory cusplets present at lingual aspect of crown of upper left second molar. Upper right central incisor and upper left lateral incisor are shovel-

			shaped (mild expression). Upper canines exhibit grooved cilingulums.
60	Male	30-40	Grooved cilingulums at upper central incisors, lateral incisors and canines
70	Female	35-45	Peg-shaped upper left lateral incisor
91	Female	45+	Wide diastema (gap) between upper central incisors

### *Palaeopathology Analysis*

Skeletal manifestations of disease were frequently encountered in both the adult and subadult samples of the Littlemore assemblage. The discussion below outlines the prevalence rate of pathology in both samples and summarises the various pathological lesions identified in the material according to their primary aetiology, broadly categorised under the headings of trauma, neoplastic, congenital/ developmental, metabolic, joint, vertebral, infectious and miscellaneous disease (i.e. diseases to which a specific aetiology could not be assigned). Typically, individuals exhibited skeletal changes representing more than one type of disease process. In other cases differential diagnosis of skeletal lesions led to several possibilities for the lesion's cause but no definitive conclusions. For this reason the CPR% rates reported below for disease prevalence are the absolute maximum for each of the disease categories.

With the perhaps notable exception of metabolic disease, all of the remaining disease categories were identified in the adult sample. Extra-spinal joint disease was the most frequently encountered lesion followed by non-specific inflammation (Figure 9). Skeletal disease was less frequent in the subadult sample. Here there were no cases of extra-spinal joint disease, vertebral joint disease, neoplastic disease or miscellaneous disease. In contrast to the adult sample metabolic disease was the most frequently encountered lesion in the subadult proportion of the assemblage (Figure 10).

### ***Figure 9 CPR% pathology in adult sample according to primary aetiology***

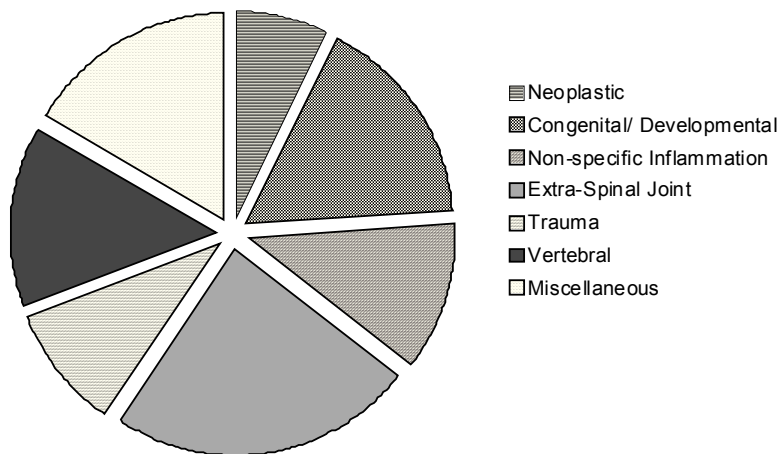

*Figure 10 CPR% pathology in subadult sample according to primary aetiology*

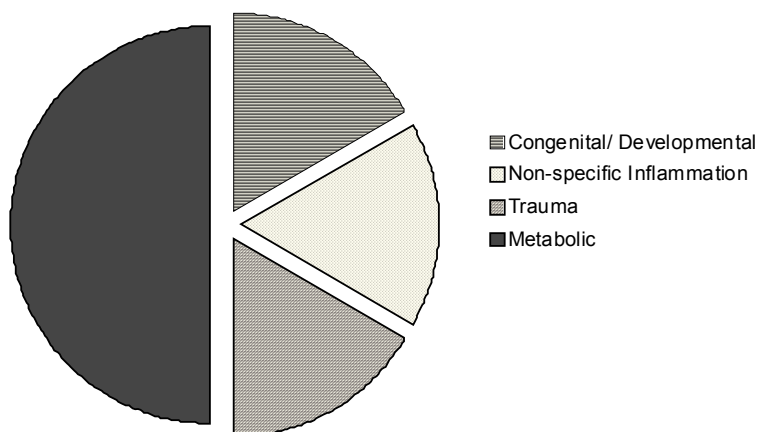

### *Background to Subadult Skeletal Health*

During the Victorian period in Britain infant-feeding practices amongst the middle and upper classes were largely determined by what was considered fashionable. The majority of middle-class women employed wet nurses to breast feed their newborn children, and if done too early may have deprived the infant of crucial sustenance in the form of nutrient-rich colostrum (i.e. the first milk produced by a newly delivered mother prior to mature breast milk) in the days after their birth. Artificial hand-feeding of infants typically with paps or panada also became popular during this period (Roberts and Cox 2003). These types of powdered baby foods were

generally composed of a mixture of flour, water and sugar and were of very low nutritional value. If these types of practices were common amongst Littlemore Chapel's congregation then infants born to these families would almost certainly have suffered compromised immunity to the array of infectious diseases of the age (see above).

Middle-class children, being required to attend school and nursery, were also much more likely to spend more time indoors than their working class counterparts. The Victorian upper-classes often kept their children out of the sunlight as much as possible so as to avoid them taking on a "working-class" colour (The Victorian Web). This type of practice may have affected levels of Vitamin D in their growing children, crucial to the mineralization of healthy bones.

### *Metabolic Disorders*

Metabolic disorders is an umbrella term for disease processes caused by a disruption of bone formation, remodelling, mineralization or a combination of these causative factors (Brickley 2000). Rickets, scurvy and anaemia are amongst the most commonly encountered diseases of this type in postmedieval skeletal assemblages. Skeletal manifestations of metabolic disease include enamel hypoplasias, ecto and endo-cranial lesions (i.e. pathological changes on the external and internal surfaces of the cranial vault) and bone hyperostosis.

Three infants, Skeleton 66 and Skeleton 67 from the unnamed sample aged at between 5-12 months and 6-12 months respectively at their time of death, and Skeleton 73b, identified as Catherine Anne Seaman aged 22.8 months at her time of death, all exhibited extensive ecto-cranial lesions on the cranial vault. The lesions presented as a mixture of new bone formation and expansive lesions of the diploë resulting in destruction of the outer table of bone, the latter type of lesion most notable on the roofs of the eye orbits and perisutural regions of the skull vault. In all three cases these pathological changes coincided with compromised mineralization of the postcranial bones manifesting as an extremely porous woven-bone appearance to the bone surfaces indicative of disorganized bone turn-over and growth and demonstrated most severely in the case of Skeleton 67. Severe dental enamel hypoplasia was identified in the dentition of Catherine Ann Seaman (Skeleton 73b) and was further testimony to on-going physiological stress endured by this particular infant most likely from birth (see above). In addition this individual, along with Skeleton 67, exhibited "type 1" endocranial lesions (Lewis 2007) which were unhealed at the time of. Lesions of this type are thought to arise following inflammation or haemorrhage of the meningeal blood vessels often as a secondary consequence of chronic meningitis, trauma, anaemia, neoplastic disease, venous

drainage disorders and tuberculosis. Porosity at the sphenoid was noted in the case of Skeleton 67, a feature thought to be pathognomic of scurvy (Ortner and Ericksen 1997).

Overall the distribution of lesions in these cases suggests more than one type of nutritional deficiency as a causative factor. Rickets, iron-deficiency anaemia and scurvy are all possible differential diagnoses. The absence of typical rickets deformity (i.e. bowed longbones) in these individuals may suggest that their ill-health had stopped them from walking or crawling. Skeleton 73b, Catherine Anne Seaman, was recorded as having died within two weeks of her younger sister, Edith Ellen Seaman (Skeleton 73a). The close timing of their deaths may be coincidental, but also raises the possibility of contagious illness as a possible cause of death, which has left no trace on either of these individuals' skeletal remains.

### *Stunted Growth*

Dental development and timing of tooth eruption are thought to progress normally even in times of physiological stress (Larsen 1997). For this reason it is often useful to compare growth achieved, as reflected in longbone length measurements, compared with dental development. A total of 4 subadults had longbones sufficiently intact to determine longbone length along with dentition, two of whom (Skeleton 66 and Skeleton 67) demonstrated significant stunted growth. Gross pathological changes indicative of long-standing metabolic disorders were present in both individuals (see above) who showed growth retardation of a minimum of 3 months behind that expected from their dental development. The remaining two observable individuals, Skeleton 69 and Skeleton 75 from the unnamed sample, both had achieved their expected level of growth having diaphyseal lengths that were consistent with their dental development. Importantly, these individuals did not exhibit signs of nutritional deficiency on their skeletons.

### *Trauma: Possible Evidence of 'Battered Child Syndrome'*

Skeleton 66, from the unnamed sample, exhibited a suite of pathological changes, some of which were indicative of a long-standing metabolic disorder (discussed above). The identification of a rib fracture in the process of healing, however, coupled with unhealed endocranial lesions on occipital bone and isolated lesions of unhealed periostitis (non-specific bone inflammation) on the ilia and right tibial shaft are indicative of 'battered child syndrome'. 'Battered child syndrome' was first introduced as a diagnostic term by Kempe and co-workers abuse (Kempe et al. 1962) to describe the range of skeletal lesions encountered in children from modern populations known to have suffered long-term physical. These studies



noted rib fractures in subadults below the age of 3 years, particularly in differential stages of healing, as being virtually diagnostic of physical child abuse, as they are seldom seen in infants and young children even in response to violent trauma (e.g. automobile accidents). Localized areas of subperiosteal new bone formation (i.e. periostitis) of traumatic origin are also typically present in the skeletal remains of children who die from chronic physical abuse, as seen in the present case. These "bone bruises" are produced by blows that cause subperiosteal bleeding and by the periosteum (i.e. the fibrous sheath that covers the bone) being stripped away from the bone when a child's arm or leg is grabbed and used as a "handle" by the abuser (Walker, in press).

Collectively the skeletal lesions identified in the case of Skeleton 66 are by no means representative of a definitive case of "battered child syndrome". The highly diagnostic feature of multiple fractures in various stages of healing are not present in this case, although cases of multiple trauma in subadult remains are noted by Walker (in press) as being "exceedingly rare" in archaeological populations. It is also a possibility that complete healing of fractures may have occurred leaving no macroscopic marker on the bone. The presence of periostitis on the ilia and right tibia may also be indicative of an underlying non-specific infection and not necessarily the result of trauma. Considering the extremely poor health of this individual and the apparent compromised mineralization of many of their skeletal elements due to underlying nutritional deficiency, it is reasonable to suggest bone weakening as a possible cause for the rib fracture, although this does not explain the presence of the periostitis.

Skeleton 66's burial, along with those of young adult female Skeleton 58 and perinate Skeleton 61, was associated with the following memorial inscription:

*Elizabeth Greenaway died April...aged... William Henry Greenaway died May 6th 1873, 10 months. Henry Watts Greenaway died Dec 2 1875 aged 2 months. Ernest John Greenaway died May 25 1878 aged 8 months. The sister and children of Henry and Elizabeth Greenaway of Oxford*

Stratigraphic evidence did not allow a definitive identification of the associated skeletons, however it may be reasonable to assume that Skeleton 66, at the very least, represented the remains of an infant boy, and more than likely those of William Henry Greenaway. Due to the inconclusive nature of this evidence, however, Skeleton 66 was included in the unnamed sample for posterity.

*Background to Adult Skeletal Health*

The Victorian period in Britain witnessed the rise of the middle-classes, categorised as the families of men who undertook so-called "clean" work (i.e. non-manual labour) such as business, commerce and politics and earned a monthly or annual salary. Middle-class women were largely confined to the domestic sphere to emphasise the commonly accepted contemporary ideology of women's separation from the world of work. In avoiding the hazardous conditions of factory or manual labour and creating spacious homes in which to live, middle-class families were far less exposed to the array of public health risks endured by their working-class counterparts. For members of the Littlemore Baptist Chapel congregation, living in a rural setting as opposed to the heavily populated urban centre of Oxford, the risk of exposure to infectious disease was even more reduced. Towards the mid 19th-century central government had responded to the public health crisis in Britain and took increasing interest in and responsibility for public health. For those who could afford it, including members of the middle classes, access to medical treatment was easily attained. In this context it is perhaps to be expected that the diseases encountered in the Littlemore adult assemblage are of the types commonly associated with longevity. Certainly, the mortality profile of the Littlemore assemblage shows a peak in deaths in infancy after which point the majority of individuals appear to have survived well into old age. According to Roberts and Cox (2003) those living into old age during the postmedieval period were more likely to be from the upper socio-economic strata of society (e.g. evidence from crypt burials versus earth-cut burials at Spitalfields, London; Molleson and Cox 1993).

Pathology recorded in the Littlemore adult sample reflects the longevity of individuals as well as an apparent lack of prolonged heavy manual labour. Trauma rates are notably low, in contrast to skeletal assemblages from the same period but of lower socio-economic status (e.g. St Luke's, Islington). The overall picture of adult skeletal health illustrates a population engaged in minimal physical labour and enduring a relatively low pathogen load with respect to infectious disease. Table 12 outlines a summary of all pathological lesions encountered in the adult sample according to skeleton number.

#### *Congenital/ Developmental Anomalies*

Congenital abnormalities are defined as those diseases present at birth. They are caused by pathological changes to normal development during the intrauterine stage of life (Aufderheide and Rodríguez-Martín 1998). Congenital defects are frequently expressed on the skeleton, with a reported prevalence rate of as much as 40% of all congenital abnormalities observed at birth (Aufderheide and Rodríguez-Martín 1998, 51) and are thought to have both genetic and

in some cases environmental causative factors. Congenital defects were observed in 7 individuals from the adult sample (CPR 47%; n=7/15). In all but one case the defects were minor and likely to have had little or no clinical impact on the individual's lives.

#### (i) Vertebral Defects

A total of 5 individuals had developmental defects of the spine. Skeleton 60 and Skeleton 90 exhibited aplasia of the posterior neural arch of atlas where the posterior neural arch failed to fuse leaving a small opening; a cleft expression in the case of Skeleton 60 and bifurcated in the case of Skeleton 90. This type of defect is not uncommon and thought to have a frequency of 5% in the majority of populations (Bailey 1974). These individuals were more than likely unaware of this defect in life as the missing portion of bone is generally in-filled with tough fibrous tissues (Barnes 1994, 267). Interestingly, both individuals also exhibited aplasia at the posterior neural arches of a number of sacral segments, specifically at the 4th sacral segment in Skeleton 60 and the 1st and 2nd sacral segments of Skeleton 90. One individual, Skeleton 87 identified as Ann Bartlett from the named sample, had complete spina bifida occulta (i.e. non-union of the posterior arch from the level of the first sacral segment through to the fifth sacral segment) representing the only case of this defect in the Littlemore assemblage. This condition was likely to have had no clinical significance in life.

Border shifting at the thoracolumbar region of the spine, where the morphology of the affected vertebrae mimics that of another type of vertebrae, was observed in two individuals, Skeleton 62 and Skeleton 70. In the case of Skeleton 62 there was partial lumbarisation of the 1st sacral segment, whilst in the case of Skeleton 70 both lumbarisation and sacralisation occurred. In this latter case a supernumerary lumbar vertebrae was present exhibiting sacralisation whilst the 12th thoracic vertebrae had also taken on characteristics of the lumbar vertebra below.

#### (ii) Cranial Defects

Skeleton 58, a young adult female from the unnamed sample, exhibited agenesis of the sagittal suture and partial agensis or premature closure of the coronal suture. This type of defect is thought to have a genetic base and normally results in various types of cranial deformity, in this particular case brachycephaly (i.e. an abnormally rounded vault) (Barnes 1994, 152-3). As a direct result of this deformity, Skeleton 58's cranial height/ length indices were significantly greater than those of the other adults in the assemblage. Sutural agenesis of the coronal and sagittal sutures is commonly associated with Crouzon's syndrome, a group of

disorders caused by developmental delay of the cranium and face (Barnes 1994, 154). In addition to being particularly short in stature, Skeleton 58 exhibited a number of morphological traits associated with the syndrome including abnormally far apart eye orbits, a high prominent forehead, a short nose and overcrowding of the dentition in the mandible.

Common clinical problems associated with Crouzon's syndrome include obstruction of the airways, abnormalities of the eyes (most characteristically exophthalmos or protrusion) and in some cases deafness due to blockage of the ear canal and less frequently learning disabilities. Skeleton 58 also showed signs of physiological stress in childhood, exhibiting the most severe case of dental enamel hypoplasia of the adult sample (see Dental Enamel Hypoplasia). Although not a definitive case of Crouzon's syndrome, it is reasonable to assume that Skeleton 58's unusual facial features and head-shape would have given her a distinct appearance in comparison to other individuals from the Littlemore assemblage. It may also be of significance that Skeleton 58 was the only individual who appeared to have been interred in non-funerary dress.

### (iii) Post-cranial defects

A number of congenital defects of the post-cranial skeleton were identified in the adult sample. Skeleton 70, a young adult female from the unnamed sample displayed an unusual developmental defect of the manubrium, one of a number of congenital defects affecting this individual. In this case an additional segment of bone was present at the region of the jugular notch, which articulated with the superior aspect of the manubrium. This same individual also presented with bilateral os acromiale. This particular lesion is defined as non-union of the final acromial epiphysis and is found more commonly in males than in females (Hunt and Bullen 2007). Although the aetiology of os acromiale is not, as yet, fully understood, it is generally thought to be connected to either hereditary control or activity-induced trauma (ibid.). The condition is relatively rare in archaeological dry bone. It has been attributed in some archaeological cases to specific occupational activities such as archery (ibid.). Clinically, individuals who present with os acromiale often complain of limited mobility and/or pain of the shoulder region (ibid.).

A total of 3 cases of symphalangism (i.e. congenital fusion of one or more of the proximal, intermediate or distal foot phalanges of the same digit) were identified in the adult sample affecting Skeleton 70 from the unnamed sample and Skeleton 87 and Skeleton 85 from the named sample, identified as mother and son Mary and Isaac Grubb. Symphalangism has been

recognised as a highly hereditary defect and so it is not surprising to see it occurring between related individuals in the Littlemore assemblage.

### *Neoplastic Disease*

Three cases of neoplastic disease were identified in the Littlemore adult sample giving a crude prevalence rate of 20%. One of the cases identified was of a benign tumour, however the remaining two cases were likely to represent malignant forms of cancer. Neoplastic diseases involving the skeleton can be broadly categorised as primary bone tumours (i.e. those that develop initially in the bone), secondary bone tumours (i.e. those that spread to the bone) and finally soft tissue tumours that result in a bony response (Anderson 2000). The precise aetiology of the majority of neoplastic diseases is unknown, however it is generally accepted that cancerous tumours arise due to a combination of physical, chemical and/or viral agents (Aufderheide and Rodríguez-Martín 1998). Primary or secondary malignant cancers are exceedingly rare in archaeological populations with an estimated 2% of males and between 4-7% of females showing skeletal manifestations of malignant carcinoma (Wells 1964). Adults from the Littlemore assemblage therefore have a remarkably high prevalence rate of cancer.

#### (i) Metastatic Carcinoma

Skeleton 74, identified as William Cutcliffe from the named sample, exhibited extensive lytic and sclerotic lesions affecting the cranial vault, a number of vertebrae, scapulae and the pelvic region. The morphology of these lesions was consistent with metastatic carcinoma. Metastatic bone tumours arise as a secondary consequence of a primary cancer most frequently involving the breast, lung, prostate, kidney or thyroid. In such cases cancerous cells are spread from the primary tumour via a number of routes including the vascular and lymphatic systems and in cases of secondary brain tumours via cerebrospinal fluid in the spinal column (Waldron 2009). In the case of Skeleton 74, the most dramatic lytic lesions occurred across the cranial vault (Plate 1). A total of 10 spherical lesions, ranging in diameter from between 11mm to 56mm, some of which had resulted in complete perforation of the bone were observed here. Reactive woven bone deposits and marginal pitting were frequently associated with these lesions of bone loss. Spherical lytic lesions were also present in the spine and involved the bodies of the 11th thoracic vertebra and the 1st, 2nd and 4th lumbar vertebrae. Periosteal new bone was identified on the right ilium in association with extensive pitting and thinning of the bone. These new bone deposits were present on both the ventral and dorsal aspects of the bone, but were thickest on the dorsal side. Reactive bone was also identified at the proximal shaft of the right femur, and the right and left scapulae. Although not conclusive, a discreet

probable lytic lesion was also present on the lateral border of the right scapulae immediately inferior to the glenoid fossa. Reactive woven bone deposits were also identified at the articulating body surfaces of the 3rd and 4th cervical vertebrae indicating a possible infection of the intervertebral disc or associated tissues in this region. A localised infection at the intervertebral disc space is unusual and may be indicative of septic arthritis (in association with the severe spinal joint disease seen in the neck region of this individual; see below) possibly arising due to a compromised immune system.

The distribution of lesions in Skeleton 74 was consistent with a case of carcinoma of the prostate reported by Waldron (1997) in the skeletal remains of an old adult male from the 19th-century skeletal assemblage from St. Bride's Church, London. In this case sclerosing metastatic lesions were present on the scapulae, pelvic region and vertebrae. Other possible primary cancers resulting in similar lesions include lung cancer and kidney cancer (Waldron 2009), however the lack of involvement of the ribs makes the former possibility less likely.

#### (ii) Benign Button Osteoma

A cluster of three small button osteomas were identified on the anterior frontal bone of Skeleton 87, an old adult female identified as Ann Bartlett from the named sample. These small ivory-like lesions are a form of benign tumour and are amongst the most common neoplastic lesions seen in archaeological remains. It is unlikely that these lesions would have had clinical symptoms in life and they are likely to have gone unnoticed by the affected individual.

#### (iii) Non-specific Neoplastic Disease

An unusual case of possible neoplastic disease was identified on the remains of Skeleton 72, an old adult male from the unnamed sample. In this case localised pitting and reactive bone was identified on the sella turcica of the sphenoid bone of the skull. A number of the erosive lesions had perforated the sella turcica floor. The sella turcica is the bony structure that houses the pituitary gland in life. Erosive lesions confined to this area may have several causes including the presence of a pituitary adenoma. Adenomas account for about 15% of intracranial neoplasms in clinical settings. Depending on the size of the lesion they may result in visual difficulties in life. A depression fracture at the left temporal bone, probably endured in childhood, was also present in this individual. It is unclear if this may have resulted or stimulated the changes seen at the sphenoid bone.

### *Extra-spinal Joint Disease*

A total of 9 adults exhibited pathological changes associated with the joints, giving an overall CPR of 60%. The youngest individual exhibiting joint disease was Skeleton 85 from the named sample, identified as Isaac Grubb who was 36 years of age at the time of his death. The frequency of joint disease was fairly evenly distributed between the sexes, and for the most part occurred in individuals over the age of 50 years at the time of death. For the purposes of this report extra-spinal and spinal joint disease will be dealt with separately.

#### (i) Osteoarthritis

Osteoarthritis is the most commonly reported pathology in archaeological bone. It can be described as a chronic and progressive non-inflammatory disease process of the synovial joints (Aufderheide and Rodríguez-Martín 1998). Lesions of osteoarthritis occur in three forms, namely: (i) breakdown of cartilage at the affected synovial joint resulting in pitting on the joint surface; (ii) reactive bone formation (sclerosis) resulting in 'surface osteophytes' on the joint surface and (iii) new bone formation (i.e. marginal osteophytes) on the joint margins (Ortner 2003). Pitting at the borders of the joint surface (i.e. periarticular resorptive foci) can also be indicative of osteoarthritis where bone loss connects to underlying subchondral cysts (ibid.). In severe cases, degradation of the joint cartilage may progress to the stage where bone-on-bone contact occurs. In such cases attrition at the joint can result in a polished appearance to part of the joint surface termed 'eburnation'. Eburnation is considered the most diagnostic of all bony changes associated with osteoarthritis (Rogers and Waldron 1995). A diagnosis of osteoarthritis was given where lesions of eburnation were present or where two or more of the other lesion types described above (either with or without eburnation) were present (Rogers and Waldron 1995). In the frequent number of cases where just one of the lesions occurred on a number of joint surfaces but without eburnation, a diagnosis of 'degenerative joint disease' was given. It is beyond the scope of this report to present such detailed data here but this information is recorded in the archive.

Osteoarthritic changes can present at any synovial joint however a predilection exists for the facet joints of the vertebrae, the hands, the hip and knee joints, the acromioclavicular joint and the first metatarsophalangeal joints of the feet (Rogers 2000). The prevalence rates of osteoarthritis show a positive correlation with increasing age. Females are more likely to present with the disease at a younger age than males (Rogers and Waldron 1995; Salter 1999). Symptoms include pain, swelling and, in more severe cases, limited range of motion of the affected joints.

Lesions characteristic of osteoarthritis were present in 7 adults, all of whom were old adults. Just over 8% of all observable joint surfaces were affected by osteoarthritic changes (TPR%; n=25/293). The most frequently affected joint(s) were in the wrist and feet accounting for 20% of all cases of OA each. Load-bearing joints such as the knee and ankle were notably unaffected suggesting that the occurrence of OA in the Littlemore assemblage may have had more to do with age and genetic predisposition than activity alone. The distribution of OA lesions according to joint type are illustrated in Figure 11.

**Figure 11 %TPR Osteoarthritis according to Joint Surface**

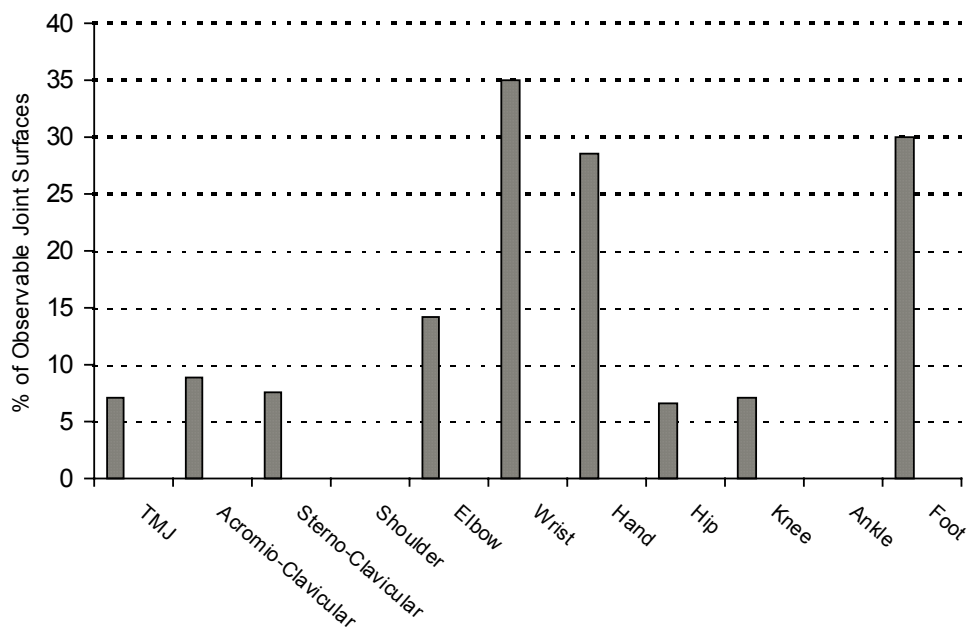

(ii) Erosive Arthropathy

“Erosive arthropathy” is an umbrella term used to describe a group of joint diseases in which bone loss at the joint surface as opposed to the proliferation of bone is the key feature. The range of diseases includes erosive osteoarthritis, rheumatoid arthritis, seronegative arthropathies and gout (Waldron 2009).

Just one individual, Skeleton 74 identified as William Cutcliffe from the named sample, exhibited signs of an unspecified erosive arthropathy involving the left 2nd metacarpophalangeal joint and right 5th metatarsophalangeal joint. Pathological changes were characterised by destructive pitted lesions affecting the articular heads and base of the opposing phalanges with proliferative new bone around the margins. Associated reactive bone



was present on the dorsal surface of the shaft of the affected metacarpal which appeared to have undergone at least partial sclerosis (healing) by the time of death. Skeleton 74 exhibited several other pathological changes across his skeleton making differential diagnosis of these erosive lesions more complex.

Ossification of the supraspinous ligaments (*i.e.* fibrous sheaths connecting the spines of the vertebrae) in this individual may suggest that the erosive changes were caused by psoriatic arthritis, or alternatively, Reiter's syndrome (Rogers and Waldron 1995). Psoriatic arthritis occurs in individuals suffering from the skin condition psoriasis and is rare both clinically and amongst archaeological populations. The pattern of erosion at the affected joints in the present case, however, had resulted in the characteristic 'cup-in-pencil' deformity often associated with this disease. Reiter's syndrome (or 'reactive arthritis') has been associated clinically with diarrheal illness such as dysentery (Rogers and Waldron 1995).

### (iii) Septic Arthritis

Lesions indicative of possible septic arthritis were identified on the right temporomandibular joint and right 2nd metacarpophalangeal joint of Skeleton 59, an old adult female from the unnamed sample. It would appear these lesions arose secondary to a deep bone infection involving the right femur (see below). Pathological changes presented as severe joint contour change in the form of infective bony proliferation on the head of the affected metacarpal and the base of the opposing phalanx. Associated reactive bone occurred circumferentially around the distal half of the metacarpal shaft resulting in a thickened diaphysis, which appeared to have undergone healing prior to death. Similar changes were also present on the right mandibular condyle where a discreet patch of woven bone was visible within a subchondral cyst revealed by post-mortem damage to the joint surface. Proliferative of new bone, probably as a result of infection, was also present at the joint.

Septic arthritis can affect almost any joint and is spread via bacteria in the bloodstream (Waldron 2009). In severe cases the synovium of the joint becomes inflamed and the articular cartilage is destroyed. Evidence of the narrowing of joint space was confirmed in the case of Skeleton 59 by the presence of eburnation on the head of the affected metacarpal and correspondingly on the base of the articulating phalanx and also on the affected mandibular condyle. Fusion of the bones ('ankylosis') of the affected joints is another frequent outcome of this condition, however this is not seen in Skeleton 59. Treatment with antibiotics or lancing of the swollen joint may have resolved the condition in this particular individual thus explaining the apparent healed appearance of the lesion in the hand and the absence of

ankylosis. If untreated the condition can be very painful, and certainly its presence in the jaw would have caused considerable discomfort in life for this individual.

### *Spinal Joint Disease*

Due to the greater complexity of joint disease aetiology in the vertebral column and the variety of joint types in this region, lesions of joint disease observed in this part of the body were considered separately to those occurring in the extra-spinal skeleton. A total of 13 individuals from the adult sample had one or more vertebrae with all vertebral facets (*i.e.* superior and inferior intervertebral facets and costal facets) intact totalling 1224 observable joint surfaces. Fourteen individuals had one or more intact vertebral bodies (*i.e.* with both the superior and inferior surfaces complete) totalling 298 vertebral bodies or 586 observable vertebral body surfaces (including the superior body surface of the 1<sup>st</sup> sacral segment).

#### (i) Osteoarthritis of the Synovial Joints of the Spine

Eight of the 13 individuals with one or more observable vertebrae exhibited signs of degenerative joint disease or osteoarthritis (as defined by the criteria outlined under *Osteoarthritis above*) affecting the synovial joints of the spine giving a crude prevalence rate of 61% (n=10/13). Interestingly, 2 of the 5 individuals with no signs of degeneration of the spinal joints were old adult females; Skeleton 83 from the unnamed sample and Skeleton 89 from the named sample, identified as Mary Grubb aged 67 years at her time of death. The remaining individuals were young adults as is to be expected. The lack of degenerative changes in the spines of Skeleton 83 and Skeleton 89 may be a reflection of a lifestyle involving minimal heavy physical work where the load-bearing joints of the spine would be expected to exhibit signs of wear and tear.

Osteoarthritis involving the apophyseal and costal joints of the vertebrae was observed in just two individuals from the adult sample, specifically in the neck of Skeleton 62, an old adult female, and the lower back of Skeleton 72, an old adult male, both from the unnamed sample. Lesions of degenerative joint disease (*i.e.* pitting and/or osteophytosis occurring without eburnation) were also found extensively throughout the spinal joints in both cases.

Figure 12 illustrates the distribution of osteoarthritis versus DJD in the spinal joints according to vertebral region.

**Fig. 12 Number of Cases of Spinal Joint OA according to vertebral region**

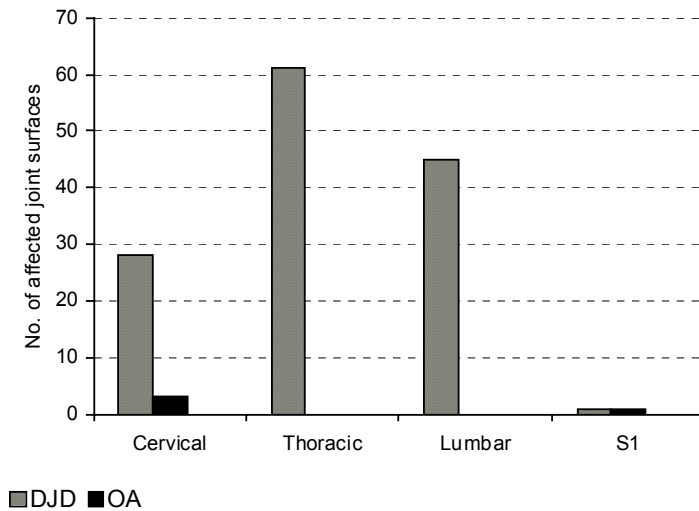

(ii) Degenerative Disc Disease

Degenerative disc disease is a disease process is stimulated by degeneration of the intervertebral disc and thus the intervertebral space between the bodies of opposing vertebrae. Spinal osteophytosis usually occurs as a response on the margins of the superior and inferior surfaces of the vertebral bodies. Here osteophytes originate from the point of attachment of the fibres of the intervertebral disc and tend to develop horizontally, but can turn vertical if sufficiently large (Rogers and Waldron 1995). Reactive new bone formation and pitting on the vertebral body surfaces is also typical (Rogers and Waldron 1995; Ortner 2003).

Lesions characteristic of degenerative disc disease were observed in 13 out of the 14 individuals with one or more observable vertebral bodies giving a CPR of 92%. This rate greatly exceeds that reported for King’s Lynn Baptist assemblage where 56% of adults exhibited spinal disc lesions (Boston 2005). The higher rate of degenerative disc disease seen in the Littlemore adult sample may be a reflection of longevity. Figure 11 illustrates the distribution of degenerative disc disease according to vertebral region. Lesions of the cervical and thoracic regions were more commonly encountered than lesions in the lumbar and first sacral segment.

(iii) Schmorl’s Nodes

Schmorl’s nodes are identified on dry bone as shallow to deep areas of bone resorption on the vertebral end plates. These lesions are ‘pressure defects’ arising when the intervertebral disc

herniates allowing the nucleus pulposus to bulge out putting pressure on the underlying bone (Rogers and Waldron 1995). Herniation of an intervertebral disc is usually a gradual process in adults in connection to the age-related weakening of the posterior longitudinal ligaments of the vertebrae, but can also occur in connection to a single incident such as a fall or a jump from a height onto the feet sending a sudden impact through the lower limbs and spine (Lovell 1997). The resulting injury is often associated with an acute initial pain termed lumbago (Martini et al. 2003) and depending on chronicity may result in the debilitating condition known as sciatica. Schmorl's nodes are most commonly identified in archaeological bone in the lower back region.

Of the 14 individuals with one or more observable vertebral bodies just 3 (CPR 21%) exhibited Schmorl's nodes; Skeleton 58, a young adult female; Skeleton 60, a middle adult male and Skeleton 70, an old adult male. In all three cases the lesions occurred in the thoracic region of the spine. The frequency of Schmorl's nodes in the Littlemore assemblage is lower than that reported at St. Luke's (Boston 2005) where 28% of individuals presented with lesions of this type in their spines. The lack of Schmorl's nodes in individuals from the Littlemore assemblage supports the biographical evidence relating to members of the Littlemore Chapel congregation, many of whom were engaged in middle-class occupations with little or no need for heavy physical labour.

**Fig. 13 Number of Cases of Degenerative Disc Disease according to vertebral region**

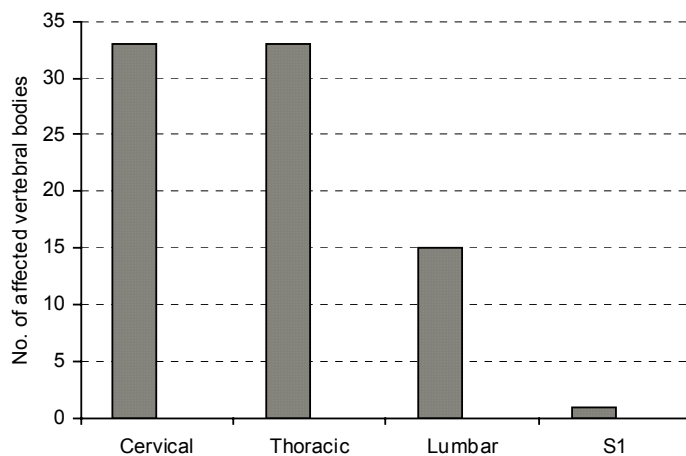

*(iv) Ankylosing Spondylitis (or Diffuse Idiopathic Skeletal Hyperostosis?)*

Lesions characteristic of both ankylosing spondylitis and diffuse idiopathic skeletal hyperostosis (DISH) were observed in the spine of Skeleton 74, that of old adult William

Cutcliffe from the named sample. The type and distribution of lesions observed precluded a definitive diagnosis of which of the two conditions was the cause, or indeed if another disease process was at play.

In the present case generalised ossification of the supraspinous and intraspinous ligaments was observed proceeding inferiorly from the level of the 11<sup>th</sup> thoracic vertebra. Proliferative osteophytosis was also present at the margins of the cervical vertebrae becoming less severe down the remainder of the spine. Bony ankylosis had occurred at the left apophyseal joints of the 2nd and 3rd lumbar vertebrae.

The lesions observed in the spine of Skeleton 74 coincide with severe degenerative disc disease on the cervical vertebral bodies and calcification of the intervertebral disc between the 2nd and 3rd lumbar vertebrae with associated marginal osteophytosis. Skeleton 74 also exhibited a tendency for enthesophyte formation at multiple muscle insertion sites throughout the skeleton and ossification of the thyroid cartilage. Taking this into consideration it would appear that Skeleton 74 was a "bone-former" i.e. an individual with a tendency to ossify soft tissues in response to skeletal stress (Waldron 2009). This may explain the high frequency of bony responses to stress seen in the skeleton of Skeleton 74 who suffered from a variety of afflictions in life resulting in bone formation. Bone forming may also be as a result of an underlying disease process.

Ankylosing spondylitis is a distinct disease process characterised by inflammation of multiple articular and periarticular structures frequently resulting in bony ankylosis at the affected joints. This disease process is normally classified as a chronic and progressive form of seronegative arthritis. It has a predilection for the axial skeleton affecting most frequently the sacroiliac joint and intervertebral joints. In clinical cases the disease occurs most frequently in young adult males with on-set normally in the second decade of life. Common symptoms of ankylosing spondylitis are chronic lower back pain and stiffness. The absence of sacroiliac joint involvement in the case of Skeleton 74 is somewhat unusual as the disease process normally begins in this region progressing from here up the spine.

An alternative diagnosis relating the spinal changes seen in Skeleton 74 may be diffuse idiopathic skeletal hyperostosis (DISH), a disease normally occurring in elderly individuals (Rogers and Waldron 1995). DISH is characterised by ossification of the anterior longitudinal ligament, which fuses the vertebral bodies together but retains the intervertebral disc space. Other spinal ligaments may also become ossified, particularly the sacral ligaments. Calcification of soft tissues often occurs, as is seen in the present case involving the thyroid

cartilage and one of the intervertebral discs (see above). Enthesophyte formation at extraspinal sites is also common in cases of DISH, and is seen in this present case also. The absence of involvement of the anterior longitudinal ligament however is uncharacteristic of classic DISH.

#### *Non-Specific Bone Inflammation*

Five cases of non-specific bone inflammation were identified in the Littlemore adult sample giving a crude prevalence rate of 33%. In all five cases the cause of associated skeletal changes was unclear but more than likely associated with some form of infectious disease or possibly secondary to trauma. In three of these cases the pathological changes were characterized by localized patches of woven bone deposits on the periosteal surface (i.e. periostitis) or deep bone inflammation extending into the underlying endosteal bone. In general, bone inflammation occurs in reaction to three causative factors: (i) extension of a soft-tissue infection to the bone; (ii) part of a more generalised disease process or (iii) by involvement of the bone from an osteitis or osteomyelitis of the underlying bone (Aufderheide and Rodríguez-Martín 1998). The condition is not always the result of infection, and may be the product of a number of alternative causes including trauma, cancer and haemorrhage (ibid.).

Skeleton 83, an old adult female from the unnamed sample, exhibited a mixture of both sclerotic and woven bone deposits indicating a degree of healing had taken place prior to death. In this case the bone inflammation occurred bilaterally along the lengths of both femurs and tibiae. A discreet patch of woven bone was also present on the anterior surface of the right ilium. Skeleton 59, another old adult female from the unnamed sample exhibited a deep bone infection on the distal shaft of the right femur. This lesion was possibly linked to septic arthritic changes involving the right hand and right temporomandibular joint in this individual and suggested the presence of a systemic infection of unknown primary cause (see above).

Skeleton 85, identified as Isaac Grubb from the named assemblage, also exhibited a healed lesion of bone inflammation on the cranial vault. The changes affected the left parietal and approximately one-third of the superior aspect of the frontal bone. Deposition of new bone had resulted in thickening of the vault in the affected area. The isolated nature of the lesion and clear demarcation of its boundaries discounted iron deficiency anaemia (porotic hyperostosis) as a probable cause in this case. The lesion appeared to be healed by the time of death and may have been caused by some form of scalp infection in life.

Two further cases of non-specific infection involving focal lytic destruction and periosteal bone inflammation were present at the 11th and 12th vertebral bodies of Skeleton 60 (middle-adult male) and at multiple muscle insertion locations on Skeleton 76, (young adult male), both from the unnamed assemblage.

In the case of Skeleton 60 erosive spherical lytic lesions were present at the anterior face of the body of the 12th thoracic vertebra resulting in a "moth-eaten" appearance. Associated areas of proliferative bone inflammation in the form of extensively remodelled reactive bone deposits were also present on the left and right sides of both the bodies of the 11th and 12th thoracic vertebrae. Coarsening of the trabeculae was also visible at the location of the vascular channel opening on the affected bodies. These lesions coincided with a possible expansive lesion of neoplastic origin on the right orbital roof. Isolated lytic lesions in the vertebrae are typically seen in cases of tuberculosis, however the lack of rib lesions as a sign of chronic pulmonary disease in this individual is atypical of this condition. Also atypical of tuberculosis is the presence of new bone formation on the affected vertebrae (Waldron 2009, 95). A more likely diagnosis may be brucellosis where an attempt at repair by the laying down of new bone in the early course of the disease is common. New bone formation in association with lytic foci in the vertebrae is also a feature of the disease (ibid.). In northern Europe the majority of cases of brucellosis are contracted from cattle and handling infected blood or meat (ibid). Considering agriculture was the major source of income for Littlemore and its environs during the postmedieval period, contact with cattle and other domesticated animals was certainly possible. Skeleton 60 does not exhibit the "parrot's beak" lesion of extra bone growth at the vertebral body rim thought to be pathognomic of brucellosis in the spine (Ortner 2003).

Lytic lesions in the vertebrae can also occur in cases of metastatic carcinoma, multiple myeloma, and primary bone tumors (Hershkovitz et. al 1998). The possible aneurismal bone cyst (i.e. a type of benign tumour) on the right orbital roof may or may not be significant in this case.

Other conditions resulting in lytic foci in the vertebrae include the fungal diseases blastomycosis and echinococcus. Venereal syphilis is can also result in such lesions, however the lack of lytic foci on extraspinal elements in the present case weighs against fungal or trepanomal disease as a probable cause.

Skeleton 76 exhibited multiple lytic lesions, which appeared to show a predilection for areas adjacent to muscle insertion points. Focal areas of bone destruction were identified bilaterally

on the acromion of the scapulae, resulting in complete perforation of the bone on the right side, the lateral metaphyseal ends of the femora (anterior aspect) and in the region of the cervical spine at the level of the 3<sup>rd</sup> and 4<sup>th</sup> cervical vertebrae. Deep bone inflammation was also present bilaterally on the posterior aspect of the femora and the posterior body of the sternum. The majority of lesions, both lytic and inflammatory, appeared to have been long-standing. Bone loss at the cervical spine was of a particularly unusual morphology. Here approximately 50% of anterior body of the 4<sup>th</sup> cervical vertebrae had been lost due to an erosive lesion however apparent sclerosis of the anterior body surface had resulted in relatively normal bone surface morphology. Healing was also observable at the margins of the lesions of the acromion processes. In addition multiple endocranial lesions were observed across the cranial vault. Lewis (2002) type 3 lesions were primarily concentrated in the region of the parietal bosses whilst a large type 2 lesion associated with a smooth circular depression was present at the anterior left parietal. This latter lesion may have accommodated a space-occupying lesion in life. The combination of lytic lesions with osteoblastic lesions is possibly indicative of brucellosis. Differential diagnosis must also allow for the possibility of tuberculosis, treponematoses and smallpox where lesions of similar morphology and distribution may also occur (Lefort and Bennike 2007).

### *Trauma (Table 11)*

Lesions of traumatic origin were relatively rare in the Littlemore adult assemblage, a pattern probably reflective of the middle-class lifestyle, which did not predispose them to the risks of trauma. Four adults exhibited traumatic lesions on their skeletons giving a crude prevalence rate of 27%. This rate was significantly lower than that reported in the Baptist assemblage of King's Lynn (Boston 2005) where 47% of adults showed signs of trauma. All affected individuals with the exception of Skeleton 62 were males.

#### (i) Fractures

Two individuals from the Littlemore adult sample exhibited fractures, specifically Skeleton 72, an old adult male from the unnamed sample and Skeleton 74, identified as William Cutcliffe from the named sample. In the case of Skeleton 72 a long-standing healed depression fracture was present at the squamous portion of the right temporal bone. The morphology of the fracture site suggested this injury was sustained as a result of a direct blow to the head by a moderate or small object travelling at considerable velocity. The lack of radiating fractures and the extensive healing of the wound indicates the injury was probably



sustained during childhood when the bones were more malleable (Rogers 1992). Pathological changes at the sphenoid (discussed above) could have been a secondary consequence of trauma to this region of the skull. A further two healed fractures were present at the costal end of the left 11th and 12th ribs. The location of the fractures showed correspondence between the two indicating that the fractures occurred simultaneously as part of a single traumatic event. Anteroposterior compression forces on the rib cage normally cause rib fractures in this area (Galloway 1999). In this case it would appear the force was directed anterior to the spine (ibid).

Skeleton 74 exhibited a total of two fractures, one unhealed on the midshaft of the right clavicle and the other a very well healed fracture on the distal shaft of the right radius. Extensive callus formation at the clavicle fracture site indicated that healing had begun prior to death however severe misalignment of the fractured ends of the bone had persisted. The callus formation appeared to be composed largely of woven bone suggesting the injury had been sustained relatively close to the time of death probably as a result of a fall onto the shoulder or by direct trauma to the midshaft of the bone (Galloway 1999). The healed radial fracture presented as thickening of the bone shaft due to long-standing callus formation and had resulted in secondary traumatic osteoarthritis of the right elbow joint. The fractured ends of the bone were well aligned with minimal shortening of the diaphyseal length in comparison to the left radius. Fractures of the distal shaft of the radius are commonly encountered in archaeological assemblages and are normally sustained as a result of falling onto an outstretched hand (Galloway 1999).

(ii) Myositis Ossificans Traumatica

Skeleton 60, a middle-adult from the unnamed assemblage exhibited a lesion indicative of musculo-skeletal injury at the lateral aspect of the left tibia. Lesions of this type are commonly referred to as myositis ossificans traumatica or more recently advocated by Waldron (2009) as heterotopic ossification traumatica. These lesions are known to arise from even minor muscular injury, in the case of Skeleton 60 at the site of attachment of the interosseous membrane between the tibia and fibula.

**Table 11 %TPR of Trauma involving the Major Longbones**

	# with Traumatic Lesions	% TPR
Upper Limb		
Clavicle	1	2.6 (n=1/38)

Humerus	0	0 (n=0/48)
Radius	2	3.6 (n=1/55)
Ulna	0	0 (n=0/43)
Lower Limb		
Femur	0	0 (n=0/53)
Tibia	1	2.0 (n=1/49)
Fibula	0	0 (n=0/34)

### (iii) Ossified Haematoma

An example of a probable subperiosteal ossified haematoma was identified on the left radius of Skeleton 62, an old adult female from the unnamed sample. This type of lesion is commonly encountered in archaeological skeletal material (Ortner 2003), and as the name suggests, is as a result of the ossification of an undissolved haematoma (i.e. blood clot) usually in relation to an area of blunt force trauma on the bone. The lesion presents as a smooth mass of bone visible after approximately two months of healing (Lovell 1997). The formation of a haematoma is a natural initial step in the healing process of any deep tissue or bone injury. Ossification of the haematoma occurs as a result of excessive stress placed upon the periosteum at the site of injury, which in turn prevents successful resorption of the haematoma after the initial stage of healing is complete. In this case there were no visible signs of fracture (e.g. fracture line or malunion) and the lesion appeared to be very well healed by the time of death.

### *Miscellaneous Pathology*

During analysis lesions uncharacteristic of the disease categories outlined above were recorded and discussed here as miscellaneous cases of pathology.

#### (i) Benign Bone Cyst

In addition to defects of the spine, Skeleton 60 (a middle-adult male from the unnamed sample) had an unusual contour deformity of the right orbital roof. The defect presented as a raised area of bone, roughly oval in shape, in the postero-lateral portion of the orbit at the site

of the speno-frontal suture extending approximately 6.69mm into the orbital space. The morphology of the lesion coupled with normal development of the fronto-sphenoid suture suggested it was not a separate entity from the frontal bone but rather a bony response to accommodate some form of space-occupying lesion/ cyst within the interdiploic space of the orbital roof thus resulting in expansion. Probable responsive thinning of the orbital wall was present in the form of an area of pitting on the anterior aspect of the border of the lesion. One possible differential diagnosis for this lesion is an aneurysmal bone cyst (ABC). Though typically found in the metaphyses of longbones, ABCs of the eye orbit have been reported in the clinical literature (Cakirer et al. 2002). They are defined as benign "expansile lesions" of bone and usually arise before the age of 20 years (Cakirer et al. 2002, 386). The lesion may have had clinical consequences in life relating to the shape of the eyeball possibly resulting in downward displacement of the eye (Rootman 2003, 426) or impingement of sight. The orbital structure is complex and as a result is highly susceptible to morphological variations that arise during development, including contour abnormalities. In the case of Skeleton 60, however, probable reactive bone loss (i.e. pitting) at the margin of the lesion seemed to indicate the presence of an expansive-type lesion encroaching into the orbital space rather than a developmental defect present from birth.

#### (ii) Plastic Deformation

Signs of plastic deformation of particular bones as a result of corset-wearing and possibly ill-fitting footwear were observed in a total of 3 individuals from the adult sample.

Flattening of the angle of the ribs was present in Skeleton 90, a young adult female from the unnamed sample, and Skeleton 89, identified as Mary Grubb aged 67 years at her time of death. These types of changes have been reported previously in postmedieval assemblages and are attributed to tightly fitting corsets worn over a long period of time (Molleson and Cox 1993). During the Victorian period corsets were expected to be worn by women from a young age, typically from the age of about 15. In the late 19th century concern about tight lacing resulted in widespread calls for "rational dress". Some doctors even supported the theory that corsetry was injurious to health (particularly during pregnancy).

A third individual, Skeleton 76 (young adult male) from the unnamed sample exhibited lateral deviation of the great toe in both feet. This type of deformity is termed hallux valgus, or colloquially "bunions", and is commonly associated with wearing ill-fitting shoes for long periods of time. More accurately, however, this type of deformity is defined as a biomechanical abnormality caused by a variety of conditions including flat feet, excessive

ligamentous flexibility, abnormal bone structure, and certain neurological conditions. These factors are often considered genetic and footwear exacerbates the problem caused by the original genetic deformity.

### ***Osteological Analysis Conclusion***

The Littlemore skeletal assemblage was largely characterised by a high rate of pathology relating to poor nutrition in childhood and longevity in adulthood. Trauma and infectious disease were relatively underrepresented but were overall, closely comparable to rates reported in broadly contemporary middle-class postmedieval assemblages. Neoplastic disease prevalence was notably high, however, making the assemblage unique in this respect. A number of rare pathological conditions, with few, if any parallels in the palaeopathological literature were also observed, including a case of possible [battered child syndrome] in a subadult from the unnamed sample and a possible bone cyst in the eye orbit of an adult male. A summary of the data collected during osteoarchaeological analysis is outlined for the adult and subadult samples in Tables 12 and Table 13 below.

***Table 12 Summary Adult Sample Data***

Skeleton Number	Age	Sex	Stature	Completeness (%)	Preservation Grade	Pathology Summary
58	21-38	F	146.5	75-100	1	Agenesis of the sagittal suture resulting in scaphocephaly; notably short stature. Ossification of thyroid. Enamel Hypoplasia; severely deformed tooth crowns
59	c.60	F	156.4	25-50	1	Possible septic arthritis; OA, Bone inflammation on right femur
60	30-40yrs	M	167.8	75-100	0	Cleft C1; bifurcation at S; Possible aneurysmal bone cyst at right orbit; Myositis ossificans traumatica, lytic foci on T11 and T12 with associated reactive bone deposits; Enthesopathy; Ossified thyroid cartilage
62	50+yrs	F	163	75-100	0	OA, DJD, SJD, caudal shifting at S1, Possible ossified haematoma at L radius
70	25-35yrs	F	160.3	75-100	1	Supernumerary vertebra; Sacralisation of L6, Lumbarisation of T1; Developmental defect at manubrium; Bilateral os acromiale; Bilateral symphalangism
72	60+yrs	M	N/R	75-100	2	Fractures, DJD and degenerative disc disease; Pitting on sella turcica

74	60+yrs	M	N/R	75-100	0	Metastatic carcinoma; ankylosing spondylitis/ DISH; Erosive arthropathy: psoriatic arthritis/ Reiter's syndrome; Periostitis, OA and DJD, Degenerative disc disease; Calcification of intervertebral disc; Fractures; Ossified thyroid cartilage
76	20-25yrs	M	160.4	75-100	1	Infectious/ neoplastic process resulting in osteoblastic and lytic lesions affecting variety of ligament attachment sites; Hallux valgus; Joint contour change on mandibular condyles
81	35+yrs	F	N/R	25-50	1	Rhomboid fossa on right clavicle
83	50+yrs	F	N/R	50-75	3	Bilateral periostitis at tibiae and femora; OA; Ossified thyroid cartilage
85	c.40yrs	M	169	75-100	1	Bone inflammation on cranial vault, DJD, symphalangism
87	60+yrs	F	157.8	75-100	0	Complete spina bifida occulta; Symphalangism, Degenerative disc disease and OA; Button osteomas; Ossified thyroid cart
89	60+yrs	F	159.8	75-100	2	OA and degenerative disc disease
90	16-20yrs	F	161.3	75-100	0	Cleft S1 and S2; Bifurcated arch of C1, Extensive caries; 'rampant' caries.
91	45+yrs	F	N/R	75-100	1	OA; severe degenerative disc disease at neck and lower back, Enthesophytes



**PLATE I** *Activity-related Dental Wear on an upper tooth of Skeleton 62*



**PLATE II** *Lesions consistent with metastatic carcinoma on the cranial vault of Skeleton 74*

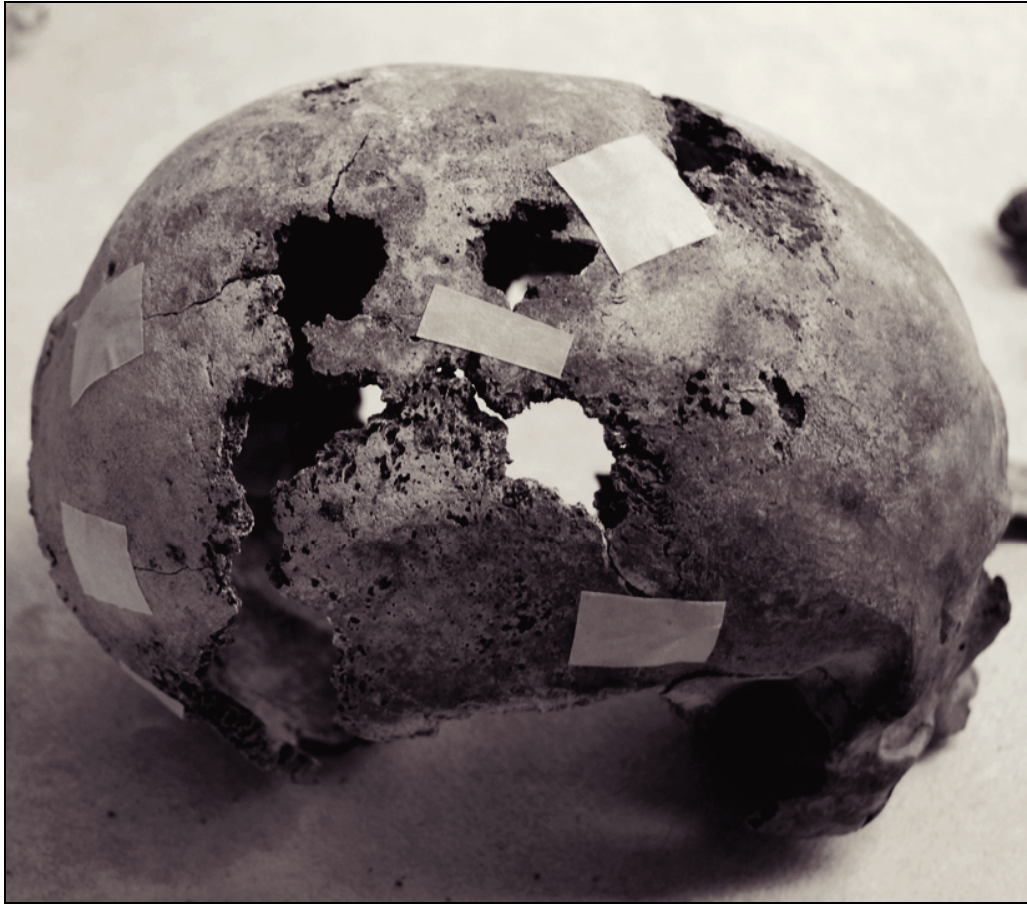



## **The coffins and coffin furniture**

By Sharon Clough

### **Introduction**

All 31 graves had evidence for a coffin. The evidence was mainly through the presence of nails, but also coffin stains, wood, coffin furniture and breastplates, which dated from 1850 onwards. Four named individuals could be identified from the surviving breast plates and biographical information from the memorials could be linked to some of the graves. All the graves had evidence for burial clothing, which was generally in the form of buttons and shroud pins. The coffins and fittings were of a standard type used at contemporary Anglican cemeteries and not plain as may be expected of a Baptist population.

### ***19th century funerary custom***

The mid to late 19th century was the heyday of the funeral, large sums of money were spent on ostentatious funerals and mourning paraphernalia, not least the coffin. Even the poorer members of society would go to great lengths to have a good 'send off', which was paramount to one's position in society (May 2003). Funeral funds and friendly societies were a means to ensure enough money was available to avoid the shameful fate of 'dying on the Parish'. As a non-conformist chapel the congregation would not be expected to follow the norms of society. It is commonly believed that Baptists were generally working-class and the theological emphasis was on eschewing worldly values and possessions in pursuit of more spiritual goals. However, records from other Baptist chapels show that it was also popular amongst the middle-class people; those in trade, yeoman farmers etc.

### ***Coffin construction***

In the 19th century the standard coffin shape was single break, or shoulder shaped that persists today. Lids were flat and it was customary to cover the coffin in fabric (or upholstery) commonly baize or velvet. Decoration became increasingly elaborate so that upholstery studs, used to hold the fabric in place, now created patterns on the sides and lid. Decorative metal adorned the coffin ostensibly as handles, known as grips (of which there were commonly 4-6 sometimes 8), used to steady the coffin as it was carried. The grips had a backing plate (grip plate), which evolved into a highly decorative and stylised piece. In addition, lid motifs and escutcheons depicting funerary symbols, were placed on the lid along side a breastplate/departum plate, which detailed the individual inside. Grips were produced by

casting but the rest of the fittings were stamped using dies, which at this time were power assisted. These could then be produced en masse and the different types depicted in catalogues for the mourners to choose from.

Excavations of the 18th- 19th-century churchyard and crypt of Christ Church Spitalfields, London undertaken in the 1980s revealed a large number of coffin fittings. The taxonomy compiled from these fittings (Reeve and Adams 1993) forms the basis for identification of styles in this period. The coffin fittings from Littlemore were compared to this and additional styles recorded from numerous other post-medieval sites excavated by OA and other archaeological contracting units. Any new types were recorded and added to the catalogue.

All the burials were coffined, which were commonly only defined by a stain, with metal fittings distributed throughout. Due to the wet and waterlogged state of the soil coffins did survive intact in some graves. A total of four intact wooden coffins were recovered, which were tentatively identified as constructed from elm; two of the coffins were double-layered. Elm was the most widely used type of wood due to its water retentive properties (Litten 1991). Iron fixing nails were used to hold the single piece sides together (and not mortice and tenon joints seen in the Baptist coffins from Broad street, Kings Lynn, Norfolk, Boston in press). Three of the coffins were covered in fabric (upholstered), which was held on by pins/studs. Fabric was used to disguise the use of several planks in the construction of one side, although in general the coffin sides comprised single planks that did not need disguising. At this time French polish (commonly used today) had not come into widespread use. Where the pattern of the upholstery pins could be observed it has been compared with the Christchurch Spitalfields types (CCS Reeve and Adams 1993). Of note were double-layered coffins 87 and 81, each had a single piece of wood that ran the length of the sides and bent at the shoulder. In order that the wood bend to the shape it had been incised on the interior in 3 vertical lines at the break for the shoulder. Commonly the sides were constructed of two pieces that were joined at the shoulder break. This method (kerfed) was observed on only the infant coffins at Christchurch Spitalfields (Reeve and Adams 1993:78).

In the 19th-century it was customary for the corpse to be laid out in an open coffin for viewing in the house of the deceased for several days before interment (May 2003). In view of this it was necessary to contain the inevitable body fluids effectively, and in addition to the use of elm for the coffin, it was commonly lined with pitch and saw dust was used to soak up the liquid. The Littlemore coffins were lined with pitch, a sealant that appeared as a black solid. Sawdust was observed in coffin 87, and shavings at the head area and may have been the stuffing for a pillow. The metal decorations are discussed below.

Table 14 : Preserved wooden coffins

Grave number	Notes
87	Double layer coffin. Outer decorated and inner plain wood coffin. Single-break shape inner coffin 171cm length. Max width 41cm. Height 32cm. Single panel wood used for each side, long side 1 piece of wood bent at shoulder using 3 grooves. Outer coffin 176cm long, max 45 wide - not as well preserved as inner. again panel single piece wood. decorated with fabric studs/upholstery pins 3 deep decoration CCS type 35. wood shavings present at head end. coffin sealed with pitch.
81	Double layer coffin. Outer decorated and inner plain wood coffin. Single-break shape. Inner coffin 174cm x 42 cm. Separated from outer coffin by a bar/nail (14cm) at each end. Outer coffin covered in fabric stud/upholstery pin pattern similar to CCS35 though inner row more oval in shape. Joints pegged at head and foot and nailed. Long side piece incised lines to create bend at shoulder.
89	single wood coffin single-break shape. Covered in fabric decorated with stud/upholstery pins 2 deep row around perimeter of panel, entire pattern not visible type therefore undetermined. Breastplate on lid. Length 166cm x 45 cm. 36cm deep.
73	Single wood coffin single-break shape. Child size. Plain wood. 82cm x 23 cm .

### *Coffin metal fittings*

Metal coffin fittings were recovered from 30 contexts. Principally they were iron made. Due to iron's propensity to corrosion (especially as it was a damp environment) the thin grip plates and breastplates (also known as depositum plates) were mostly destroyed. A total of 23 burials had grips preserved although the iron grips had developed bloom obscuring the shape and decorative detail. Despite this, three new types of grip have been identified that are not amongst the styles in OA's catalogue (Figs 15, 16 and 17). Where styles could be identified they were commonly from other Anglican sites in the Oxfordshire area, and not similar to the styles from the 18th-century Baptist burial ground at West Butts St Poole (McKinley 2008) or the Baptists from Kings Lynn (Boston in press). This suggests that local style and custom dominated choice rather than opting for a more plain style.

Curiously burial 76 had 4 grips that had the patterned side facing out and 4 which faced in (so plain side would be visible). This phenomenon was identified on a single grip from Kirtlington (Gibson 2008) (although it was the only part of the burial excavated). It can be surmised that this was either a mistake by the coffin maker, or some intention/custom now unknown.

Grip plates (Figs 2, 3 and 4) were evident for 13 graves, although it is likely that all those with a grip had a plate behind. They were all heavily corroded except three new types (Figs

14, 15 and 16). Plate 68 was made of lead and plate 74 brass, which is why these were uncorroded. Plate 87 was still attached to the coffin wood and was pressed tin painted black. There was evidence in five instances for further decoration in the form of escutcheons or lid motifs, but these only remained as very small corroded fragments.

Breastplates or depositum plates contained the biographical details of the individuals. The still legible ones were plain with incised script (see below). However fragments from the corroded iron (possibly tin dipped) plates, hinted at a more elaborate style with floral flourishes, cherubs, shells and other funerary symbols. In two cases (81 and 83) it was possible to see that they had been coloured black with painted gold lettering. Plates 72 and 81 had imprinted words around their perimeter as part of the pressed decoration. Similar plates from Christchurch Spitalfields (CCS) and St Luke's Islington (OLR) were inscribed with words such as "resurcam" and "gloria".

The iron upholstery pins (often called studs) were found in 13 graves and all were painted black and 20 mm in diameter. The quantity in each grave varied from 3 to over 400, any patterns are discussed above.

Nails were the most common find and were recovered from 20 graves; they were all handmade. Although machine-stamped nails were in circulation by the late 1860s, handmade nails continued to be made after that time. Two coffin lid screws were recovered from coffin 74, dated by its plate to 1879. Blunt end machine made screws were manufactured from the late 18th century, and pointed screws were made from the 1840s (Taylor 1999).

### ***Fabric***

As discussed above four coffins were upholstered in fabric. The preserved fabric had been stretched over each plank of wood and then tacked into place on the other side. The presence of upholstery pins suggests more of the coffins were covered than are preserved (13). The fabric was commonly woollen baize, silk being the preserve of the very wealthy. French polishing of the wood began in the second quarter of the 19th century, setting in a decline in the use of fabric.

It is most likely that the interior of the coffins were lined with textile. Evidence of the pitch that coated the base and sides of the coffins survives, and a sheet would have been tacked in place and the pitch and the sides lined. Pillows were sometimes used to support the head.

### ***Depositum/breastplates with biographical details***

In total four departum plates were legible. These are detailed in Table 15 below.

***Table 15 Departum plate details***

Grave number	Departum plate shape/style	Metal	Biographic data
74	elaborate shield max length 40 max width 31 cm	Brass	Incised script with flourishes. William Cutcliffe/ DIED/ Octr 20th 1879/ AGED/ 73 years
87	trapezoid max length 43 x 33 cm	Copper	incised script, remnants gold paint. Differing fonts and styles. ANN BARTLETT/ Died/ October 8th/ 1865/ Aged 70 years
73	2 plates trapezoid shape. 1st 27x23 cm. 2nd 23x18 cm	Brass	Incised script. 1st slight damage to left and concave. Found on coffin lid [C]atherine Anne Seaman/ Born June 2nd/ 1857/ Died April 25th/ 1859. 2nd concave. Found in fill, coffin seen as stain and burial lifted as sample Edith Ellen Seaman/ Born July 9th/ 1858/ Died May 9th/ 1859

Grave 87 contained a double coffin and the plate of Ann Bartlett and William Cutcliffe, who are both recorded on memorial stones (see section below). Grave 74 (Cutcliffe) had matching grip plates to the shield-shaped breastplate, though the coffin did not survive. The two plates found in grave 73 record infants from the same family (Seaman) who died within a month of each other, but their surname does not appear on any of the memorials.

### ***The Burial clothing of the Littlemore Baptist Chapel***

The winding sheet or shroud was abandoned in the late 17th/early 18th century in favour of special burial clothing and it was relatively unusual for individuals to be buried in their own clothes (Reeve and Adams 1993, 94). The practice in the 19th century was for the coffin to be kept at home for 2-3 days so mourners could view the body, necessitating that the body was presented in a desirable manner. Burial clothing continued to be called shrouds, which were backless but with sleeves and covered the body from head to foot. The shrouds were adorned with frills and punched decoration (a form of cheap lace) (ibid) and a body would also have a cap, with differing styles for men, women and children.

The evidence from Littlemore is for 'grave clothes' as opposed to 'normal clothes'. There were nine graves with copper alloy shroud pins, which were used to hold garments in place, such as the cap, to prevent slippage. There were also a number of graves containing two types

buttons. The cartwheel button is a punched out circle of metal, which is then threaded with cotton creating a 'cartwheel' effect. These were found in 5 graves and may have been attached at the cuffs, or shirt neck. Five other graves contained a different type of button usually found on Victorian underwear, and made of white iridescent china. Mostly they were plain with four holes, a few had a radiating line pattern. Additional buttons (grave 60), a composite bone and a metal press arrangement (22 mm diameter) were also recovered.

Grave 58 had a number of small finds that suggest that the individual may have been buried in clothing. A belt/strap end of copper alloy and another possible belt fitting of a lead alloy were recovered. In addition a black painted button of the press type was recovered, although at 17 mm diameter it was smaller than the button from grave 60. A silver chain, 120 mm in length with no end fittings was also recovered.

Grave 74 had two unidentified fittings (SF 5) made of copper alloy with leather strap attachments, which were found at the knee area. The objects are comprised identical oval disc measuring 65 mm x 50 mm. A rectangular protrusion of 5 mm was present on one side of the disc and what appears to be a rectangular clasp on the other. Screws hold the leather in place, which has been shaped and protrudes in opposite directions. Fabric was stretched over the metal and a wooden button lay adjacent (for the leather straps to attach to?). This is clearly not a dress fitting and is perhaps a kind of medical device. It is curious that skeleton 74 does not have any bony changes to the knee area.

### ***The memorials of Littlemore Baptist Chapel***

The gravestones were recorded in 1991 and missing details have been added in (in Bold) from data in the Births, Marriages and Deaths record (BMD). The gravestones were checked as they were removed for further details and any additional stones were recorded. The dates range from 1862-1888, although the coffin plate styles suggest burials were taking place slightly earlier (c. 1859).

Gravestone 1. Headstone, inscription illegible.

Gravestone 2. Headstone. Elizabeth Greenaway died April...aged... William Henry Greenaway died May 6th 1873, 10 months. Henry Watts Greenaway died Dec 2 1875 aged 2 months. Ernest John Greenaway died May 25 1878 aged 8 months. The sister and children of Henry and Elizabeth Greenaway of Oxford.

Gravestone 3. Headstone. In memory of Ann Bartlett wife of Thomas Bartlett of Oxford died Oct 8th 1865 aged 70 years. Also of Elizabeth Bartlett who departed this life August 2nd 1872 aged 85 years.

Gravestone 4. Headstone. William Cutcliffe after 48 years pastor of Baptist church at Brayford Devon peacefully fell asleep Oct 20. **1879**. At 2 Paradise Square Oxford aged 73 years. I have fought a good fight I finished my course I have kept the faith...

Gravestone 5. Headstone. Illegible.

Gravestone 6. Headstone. In loving memory of Frances Maud infant daughter of Ernest and Ellen Eldridge who fell asleep Oct 8 1875. ...sli(?)ght or sorrow diri....

Gravestone 7. Headstone. Henry Hunt of Oxford who departed this life July 30 1877 aged 72 years.

Gravestone 8. Headstone. In loving remembrance of Frank Shirley Cooper the beloved son of G W and Ann Cooper of Oxford who fell asleep August 24 18- **1868 BMD** aged 1 year and 7 months. Also of William Frank Cooper who died March 13 1876 (**1872 BMD**) aged 13 months. Also Albert Fred Cooper who died 3 Jan 18-**1875 BMD** Footstone. F.S.C. 1868. W.F.C. 1872.

Gravestone 9. Headstone. Illegible.

Gravestone 11. Headstone. In remembrance of Mary widow of Thomas Grubb of Oxford who died August 3rd 1871 aged 67 years. Also of Issac Grubb of Milwaukee U.S. America son of the above who died August 3rd 1873 aged 36 years. Footstone. M.G. 1871. I.G. 1873.

Gravestone 12. Headstone. In loving memory William Henry Herring of Sandford-on-Thames died Jan 9th 1881 aged 49 years. Also Elizabeth Herring died may 13th 1872 aged 1 year 9 months. Also Fred Herring died Dec 7th 1862 aged 8 weeks. Footstone. H.H. 1881. E.H. 1872. F. H. 1862.

*Additional gravestone recording*

Gravestone 17. Letticia, Daughter of Thomas [and wife?] Ford/ born □ □ .1860/ died Aug 27 1861 (**BMD Letitia Ford born Jul/Aug/Sept 1860**)

Using the details on the coffin plates (see below) and stratigraphic and biological analyses it is possible to reunite several individuals to their gravestones.

Skeleton 74 is William Cutcliffe (Gravestone 4)

Skeleton 87 is Ann Bartlett (Gravestone 3)

Skeleton 81 is likely to be Elizabeth Bartlett (Gravestone 3) as she lies above Ann Bartlett (Grave 87, Gravestone 3).

Skeleton 85, a mature adult male, is likely to be Issac Grubb (Gravestone 11) and Skeleton 89, an older adult female, is likely to be his mother Mary Grubb; these are appropriate ages and stratigraphically correct for the detail on the gravestone. This also the only combination of older male and female present within a grave.

### ***Named Individuals***

#### *Depositum plates*

Four plates were found lying on top of coffins (see previous section) and these are the individuals commemorated:

William Cutcliffe died Octr 20th 1879 aged 73 (Grave 74)

[C]atherine Anne Seaman born June 2nd 1857 DIED April 25th 1859 (Grave 73)

Edith Ellen Seaman born July 9th 1858, Died May 9th 1859 (Grave 73)

Ann Bartlett died October 8th 1865 aged 70 years (Grave 87)

### ***Discussion***

Assuming that the memorial and plate information represents the majority of the individuals buried at Littlemore, then we can use this data to construct a demography of this small chapel. There are 9 females and 11 males detailed as buried in the graveyard (including the two Seaman children), who are aged between 8 weeks and 85 years old.

***Table 16 Named individuals by age category***

Age Category	Number of individuals
0-1 month	1
1 month-1 year	7
1.1-3 years	4
3.1-8 years	0
8.1-12 years	0
13-17 years	0
18-24 years	0



25-35 years	0
35-45 years	1
45+	6

This is an expected range for an industrialised period, with high infant and young child mortality tailing off to rise again in the older age categories. Surprisingly absent are young adult females who may have died of childbirth related conditions. Further work into the background of some of these individuals has created a picture of the congregation. William Cutcliffe was of interest as his gravestone was particularly detailed. He was born in Marwood, Devon, and his wife was Mary from Pilton. The census of 1841 and 1851 places him in Brayford, Devon where he served as a Baptist Minister, and supports the information from the gravestone. William Cutcliffe is recorded as dying at 2 Paradise Square, St Ebbes, Oxford, aged 73 in 1879. In the 1871 census a William Harbud is head of that house, and resides with his wife Mary Ann, and Elizabeth Bartlett (aged 83) their lodger. Gravestone 3 records an Elizabeth Bartlett aged 85 dying in 1872, and she is most probably the individual named in the 1871 census. As William Cutcliffe is not recorded in 1871 and had died by the 1881 census we can assume that after Elizabeth's death he moved in as the lodger. A third lodger had moved in by the 1881 census (Amelia A. Slatter). William Harbud is recorded as a carpenter and undertaker and his wife was born in Devon, Brayford. Perhaps she was related to William Cutcliffe, and it is possible that William Harbud made Elizabeth Bartlett's and William Cutcliffe's coffins.

Other Cutcliffes lived in St Ebbes (8 King's Terrace, Oxford) and may be also be related to William; Cutcliffe was an unusual surname in Oxford but common in Devon at this time. Edward Cutcliffe from Barnstaple, Devon, was a Tailor (1841 census) and remarried an Ann Bartlett in 1854 at St Ebbes. It seems very likely that Edward and Ann were related to Elizabeth Bartlett and William Cutcliffe buried at Littlemore.

The Grubb family (Gravestone 11) are also linked to St Ebbes, as Issac was born there in December 1836. Gravestone 12, the Herring family, denotes that William was from Sandford-on-Thames and he was born in 1832 in Sutton Courtney 1832. He was married to an Elizabeth, who shared her name with their commemorated infant daughter.

### ***Conclusions***

The census information suggests that those who were buried in the Littlemore Baptist graveyard were not necessarily living in the immediate area. The individuals did not

necessarily attend the nearest chapel to home, but perhaps the one that they preferred or was attended by friends or other members of their family.

The coffins and fittings recorded from Littlemore were broadly consistent with the more widely found burial practices identified elsewhere in the post-medieval assemblages in Britain. The coffins were characteristic of those of the lower to middle classes, being generally constructed from a single skin of wood, with iron and pressed tin fittings. The individuals were mostly dressed in burial clothing with no personal items. This picture was confirmed by the memorial stone analysis, which indicated that at least some of the individuals commemorated were artisans/skilled working class.

### **Non-burial archaeology**

By Andrew Norton

The natural sand was cut by three sand quarry pits (38, 40 and 42) measuring up to 3 m wide and over 0.6 m deep, the level of the water table. The pits were backfilled with sandy loams but no finds were recovered. The pits may have been dug ahead of the construction of the chapel or were associated with backyard activity within 11 Chapel Lane. A brick lined soakaway (45) cut the fills of pit 42 and was most likely associated with the early 19th-century chapel; the pits were also cut by graves 66, 67 and 70 (Fig. 1).

A south-west to north-east grave (64) was recorded to the north of pit 40. The grave was backfilled with stone rubble and no evidence of a coffin or burial was observed; any burial was likely to have been previously exhumed.

The quarry pits, soakaway and westernmost graves were overlain by brick walls forming the southern extension to the chapel (54 and 55). The southern stone wall of the original chapel (56) was also observed; one course of stone survived, which was 0.9 m wide. A second soakaway (44) was observed to the east and may have served as a replacement to soakaway 45. A stone well (36), measuring 0.75 m in diameter, was located on the southern boundary of the churchyard and most likely associated with No. 10 Chapel Lane.

### **The Pottery**

By Paul Blinkhorn

The pottery assemblage comprised 49 sherds with a total weight of 786 g. It comprised a range of medieval and later wares, all of which were recovered from 19th-century contexts. A full record can be found in archive.

### **Acknowledgements**

Many thanks are extended to David Wilde of Carter Construction and Andrew Bevan of Littlemore Baptist Church for their assistance during the work. Special thanks go to Alan Simpson, at the Oxford Family History Society, for providing the census data. Bryan Matthews supervised the excavation and the authors are grateful for his team's hard work. Louise Loe edited the report in draft and David Radford (OCC) monitored the excavation. Thanks also go to Julia Moxham who produced the illustrations.

### **Bibliography**

Anderson, T, 2000 Congenital Conditions and Neoplastic Disease in British Palaeopathology in S Mays and M Cox (eds), *Human Osteology in Archaeology and Forensic Science*, 199-226, Cambridge University Press

Aufderheide, A, C, and Rodriguez-Martín, C, 1998 *The Cambridge encyclopaedia of human palaeopathology*, Cambridge University Press

Bailey, R, W, 1974 *The Cervical Spine*, Lea and Finger, Philadelphia.

Barnes, E, 1994 *Developmental Defects of the Axial Skeleton in Palaeopathology*, Colorado University Press

Bashford, L, and Sibun, L, 2007 *Excavations at the Quaker Burial Ground, Kingston-upon-Thames, London*, *Post-Medieval Archaeology*, **41**, 100-154

Berry, A, C, and Berry, R, J, 1967 Epigenetic variation in the human cranium. *JAnat*, **101**, 361-379

Boston, C, *et al.* 2009 The Human Bone Assemblage in C, Boston, A, Boyle, J, Gill and A, Witkin (eds) *In the Vaults Beneath: Archaeological Recording at St. George's Church, Bloomsbury* Oxford Archaeology Monograph Series No. 8, 103-137

Boston, C, in press Kings Lynn Baptist Burials, Oxford Archaeology Monograph Series, Oxford.

Boston, C, V, in press Coffins and coffin fittings of the Baptist burial assemblage, in Brown R, *Archaeological investigations at the Vancouver Centre, Kings Lynn*, East Anglian Monographs

Boyle, A, 2004 What price compromise? Archaeological investigations at St Bartholomew's Church, Penn, Wolverhampton, *Church Archaeology*, 5 and 6, 69-79

Boyle, A, Boston, C, and Witkin, A, 2005 *The archaeological experience at St Luke's Church, Old Street, Islington*, Oxford Archaeology

Brickley, M, and McKinley, J (eds), 2004 *Guidelines to the Standards for the Recording of Human Remains*. British Association for Biological Anthropology and Osteoarchaeology and Institute for Archaeologists

British History Online webpage, [www.british-history.ac.uk/](http://www.british-history.ac.uk/)

Brothwell, D, R, 1981 *Digging Up Bones*, Oxford University Press/British Museum, Oxford.

Buckberry, J, L, and Chamberlain, A, T, 2002 Age estimation from the auricular surface of the ilium: a revised method, *AJPA*, 119, 231-239

Buikstra, J, E, and Ubelaker, D, H, 1994 *Standards for data collection from human skeletal remains*, Arkansas

Caffell, A, in press The General Baptists of Priory Yard Norwich in C King and D Sayer (eds), *The Archaeology of Post-Medieval Religion*, Society for Post-Medieval Archaeology and the Society for Church Archaeology

Cox, M, 1996 *Life and Death in Spitalfields 1700-1850*, Council for British Archaeology, York

Dias, G, and Tayles, N, 1997 'Abscess Cavity' a Misnomer, *IJO* 7, 548-554

Fazekas, I, and Kósa, F, 1978 *Forensic Foetal Osteology*, Akadémiai Kiadó, Budapest

Ferembach, D, *et al.* 1980 Recommendations for age and sex diagnoses of skeletons. *JHE*, 9, 517-549

Galloway, A (ed.), *Broken Bones: Anthropological Analysis of Blunt Force Trauma*, Illinois

Gibson, M, 2008 St Mary the Virgin Kirtlington, Oxford Archaeology Watching Brief Report, unpublished client report

McKinley, J, 2008 *The 18th century Baptist Chapel and burial ground at West Butts St, Poole*, Wessex Archaeology

Goodman, A, H, and Rose, J, C, 1991 Dental enamel hypoplasias as indicators of nutritional status in M A Kelley and C S Larsen (eds), *Advances in Dental Anthropology*, Wiley-Liss, New York, 279-293

Herskovitz, I, Rothschild, B, M, Dutour, O, and Greenwald, C, 1998 Clues to Recognition of Fungal Origin of Lytic Skeletal Lesions, *AJPA* **106**, 47-60

Henderson, J, 1987 Factors determining the state of preservation of human remains in, A Boddington, A N Garland and R C Janaway (eds), *Death decay and reconstruction: Approaches to Archaeology and Forensic Science*, Manchester, 43-54

Hillson, S, 1996 *Teeth*, Cambridge Manuals in Archaeology, Cambridge

Hillson, S. 2001 Recording dental caries in archaeological human remains. *IJO* **11**, 249-289

Hunt, D, and Bullen, L, 2007 The Frequency of Os Acromiale in the Robert J. Terry Collection, *IJO* **17**, 309-317

Larsen, C, S, 1997 *Bioarchaeology. Interpreting behaviour from the human skeleton*, Cambridge University Press, Cambridge

Lefort and Bennike 2007, A Case Study of Possible Differential Diagnoses of a Medieval Skeleton from Denmark: Leprosy, Ergotism, Treponematosi, Sarcoidosis or Smallpox, *IJO* **17**, 337-349

- Lewis, M, 2004. Endocranial Lesions in Non-adult Skeletons: Understanding their aetiology, *IJO*, 14: 82-97
- Litten, J, 1991 *The English way of death- the common funeral since 1450*; Robert Hale, London
- Kempe C, H, *et al.* 1962 The battered-child syndrome, *Amer J Med Sci* **181**, 17-24
- Klein E, T, 1952 Pressure Habits, Etiological Factors in Malocclusion. *Am. Jour. Orthod.* **38**: 569-587
- Lovell, N, 1997 Trauma Analysis in Paeopathology, *Yearbook of Physical Anthropology*, Vol. 40, 139-170
- Lukacs, J, R, 1989 Dental palaeopathology: methods of reconstructing dietary patterns, in M Y Iscan and K A R Kennedy (eds), *Reconstruction of life from the skeleton*, Alan Liss, New York, 261-286
- Maresh, M, M, 1970 Measurements from roentgenograms in, R W McCammon (ed.), *Human Growth and Development*, C.C. Thomas, Illinois, 157-200
- Martini, F, Timmons, M, J, and Tallitsch, R, B, 2003 *Human Anatomy*, Pearson Education, London
- May, T, 2003 *The Victorian Undertaker*, Shire publications Ltd
- Mays, S, 1998 *The Archaeology of Human Bones*, English Heritage, London
- McKinley, J, 2008 *The 18th Century Baptist Chapel and Burial Ground at West Butts, Poole, Dorset*, Wessex Archaeology Report, Salisbury
- Meindl, R, S, Loveljoy, C, O, *et al.* 1985 A revised method of age determination using the os pubis, with a review and tests of accuracy of other current methods of pubic symphyseal aging, *AJPA*, **68**, 29-45

Miles, A, E, W, 1963 The dentition in the assessment of individual age in skeletal material in D R Brothwell (ed.), *Dental Anthropology*, Pergamon, Oxford, 191-209

Miles, A, *et al.* 2008 *St Marylebone Church and burial ground in the 18<sup>th</sup>-19<sup>th</sup> centuries: Excavations at St. Marylebone School, 1992 and 2004-2006*, MoLas Monograph Series **46**, London.

Molleson, T, and Cox, M, 1993 *The Spitalfields Project Volume II- The Anthropology. The Middling Sort*, Council for British Archaeology Research Report **86**, York

Moorrees C, F, A, Fanning, E, A, and Hunt, E, E, 1963 Age variation of formation stages for ten permanent teeth, *Journal of Dental Research* 42, 1490-1502

Ogden, A, 2005 Identifying and scoring Periodontal Disease in Skeletal Material, unpublished research paper, BABA0 Conference 2005

Ogden, A, *et al.* 2007 Gross Enamel Hypoplasia in Molars from Subadults in a 16th-18th century London Graveyard, *AJPA* **133**, 957-966

Ortner, D, and Ericksen, M, 1997 Bone changes in infancy in the human skull probably resulting from scurvy in infancy and childhood, *IJO* **7**, 212-220

Ortner, D, J, and Puthchar W, G, J, 1981 *Identification of pathological conditions in human skeletal remains*; Smithsonian Institute Press

Ortner, D, J, 2003 *Identification of Pathological Conditions in Human Skeletal Remains* Academic Press, London

OA, 2003 *Baptist Chapel, Littlemore, Oxford: Archaeological Desktop Assessment*, unpublished client report

Powers, N, 2010 Bow Baptist Church Burial Ground: Post-excavation Assessment, Unpublished report, MoLAS, London

Reeve, J, and Adams, M, 1993 *The Spitalfields project Volume 1 - The archaeology Across the Styx*, CBA research report **85**

Roberts, C, 2009 *Human Remains in Archaeology: A Handbook*, Council for British Archaeology, York

Roberts, C, and Cox, M, 2003 *Health and Disease in Britain. From Prehistory to the Present Day*, Sutton Publishing, Stroud

Roberts, C, and Manchester, K, 1995 (2nd edition), *The Archaeology of Disease*, Sutton Publishing, Stroud

Rogers, J, 2000 The palaeopathology of joint disease in M Cox and S Mays (eds.), *Human Osteology in Archaeology and Forensic Science*, Greenwich Medical Media Ltd., London, 163-182

Rogers, J, and Waldron, T, 1995 *A Field Guide to Joint disease in Archaeology*, Chichester.

Rogers, L, 1992 *Radiology of Skeletal Trauma*, New York

Scheuer, L, and Black, S, 2000 *Developmental Juvenile Osteology*, Academia Press, London.

Rootman, J, 2003 *Diseases of the Orbit: A Multi-disciplinary approach*, Philadelphia

Rugg, J, 1999 From reason to regulation 1760-1850, in P C Jupp and C Gitings (eds), *Death in England*, Manchester, 202-229

Schwartz, J, 1995 *Skeleton Keys: An Introduction to Human Skeletal Morphology, Development and Analysis*, Oxford University Press, Oxford

Suchey, J, M, and Brooks, S, 1990 Skeletal age determination based on the *os pubis*: a comparison of the Acsádi-Nemeskéri and Suchey-Brooks method, *Human Evolution* 5, 227-238

Taylor, J, 1999 Nails and Wood Screws reproduced from the Building Conservation Directory, [www.buildingconservation.com](http://www.buildingconservation.com)

The Church of England and English Heritage, 2005 *Guidance for best practice for treatment of human remains excavated from Christian burial grounds in England*

The Victorian Web 2010 <http://www.victorianweb.org/>



Trotter, M, 1970 Estimation of stature from intact long limb bones in T D Stewart (ed.), *Personal Identification in Mass Disasters, (Report of a Seminar Held in Washington, D.C., 9-11 December 1968, by Arrangement Between the Support Services of the Department of the Army and the Smithsonian Institution)*, National Museum of Natural History, Smithsonian Institution, Washington D.C. Pages 71-83

Ubelaker, D, 1989 *Human Skeletal Remains*, Taraxacum, Washington

VCH, 1957 *The Victory History of the Counties of England: A history of the county of Oxford* 5

Waldron, T, 1997 A Nineteenth-Century Case of Carcinoma of the Prostate, with a Note on the Early History of the Disease, *IJO* 7, 241-247

Waldron, T, 1998 A note on the estimation of height from long-bone measurements. *IJO*, 8: 75-77.

Waldron, T, 2009 *Palaeopathology*, Cambridge Manuals in Archaeology, Cambridge University Press, Cambridge

Walker in press, Is the Battered-Child Syndrome a Modern Phenomenon? In Proceedings of the 10th European Meeting of the Paleopathology Association

Wells, C, 1964 *Bones, Bodies and Disease*, Thames and Hudson, London

Wilkinson, D, 1992 Fieldwork Manual, unpublished Oxford Archaeological Unit guide

Workshop of European Anthropologists, 1980 Recommendations for age and sex diagnoses of skeletons

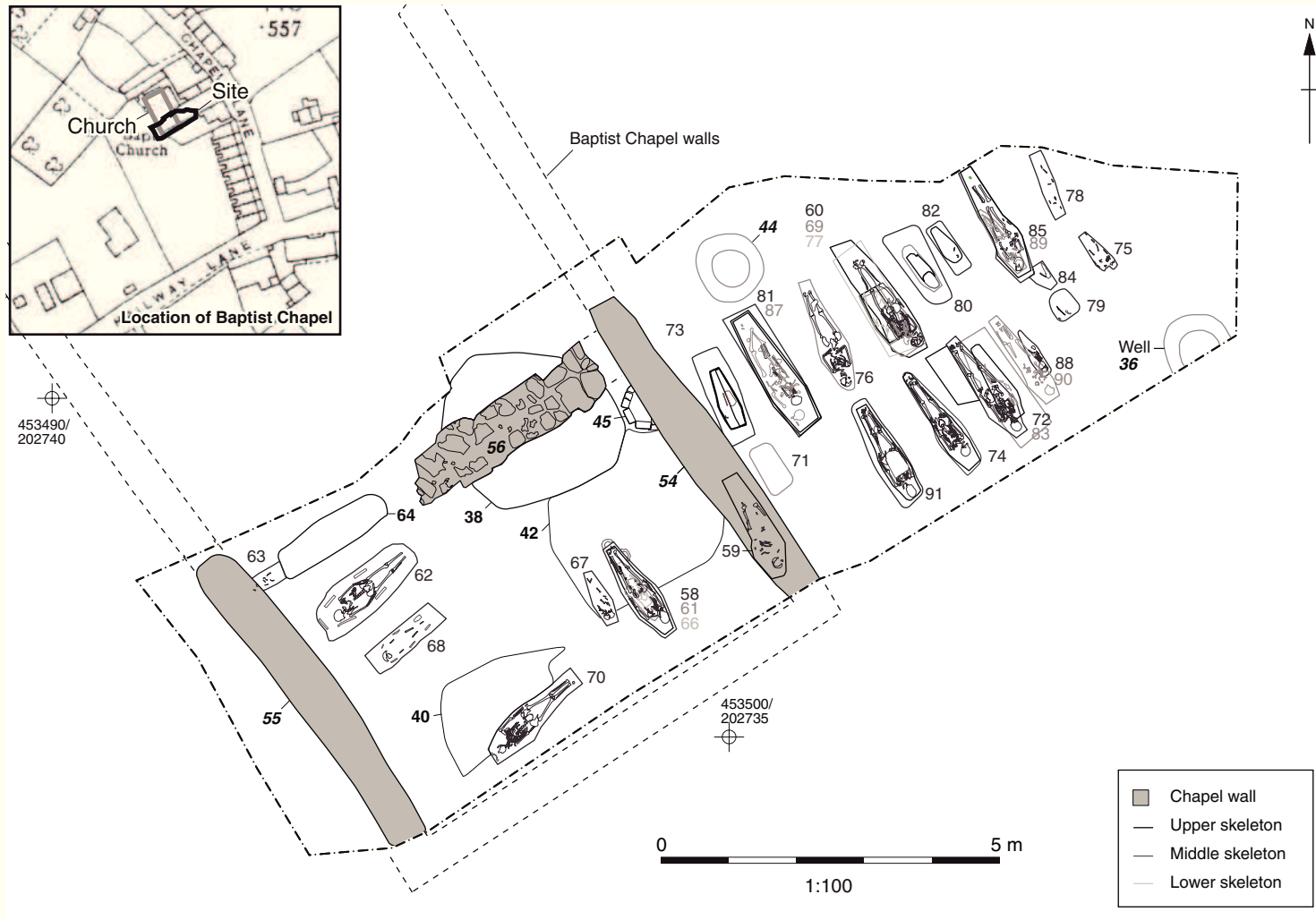

Figure 1: Site plan

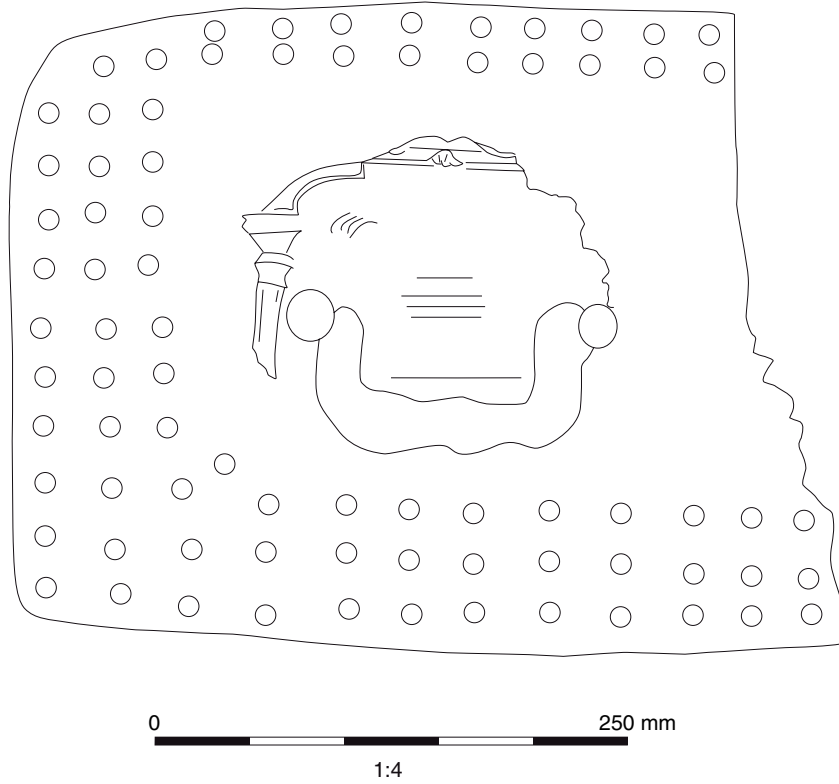

Figure 14: Outline drawing of End plate of Coffin 87

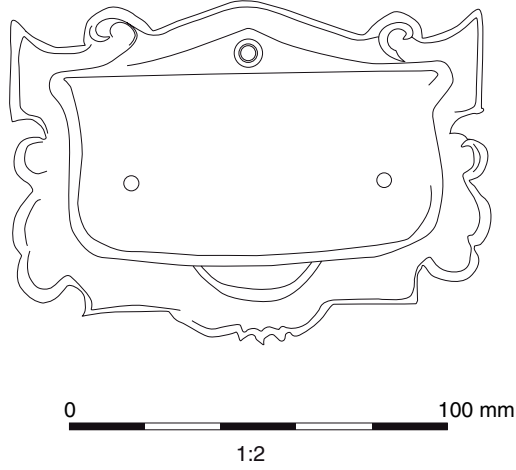

Figure 15: Outline drawing of Grip plate 68

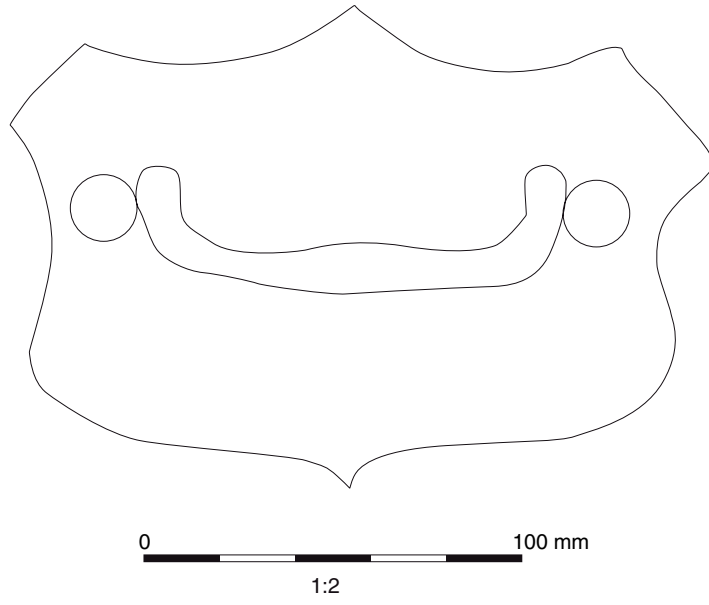

Figure 16: Outline drawing of Grip plate 74

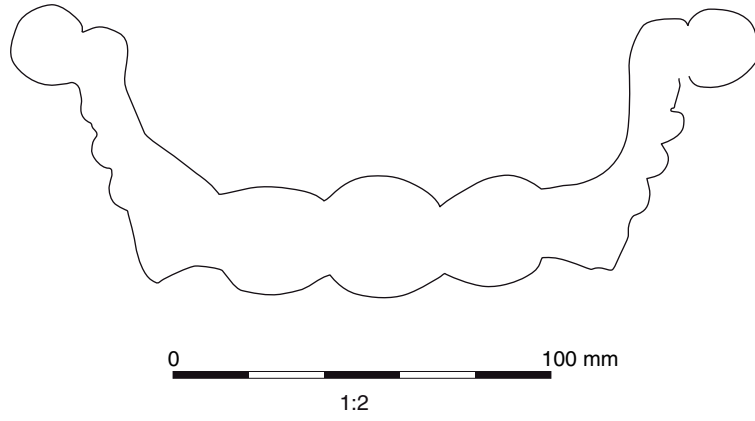

Figure 17: Outline drawing of Grip 58

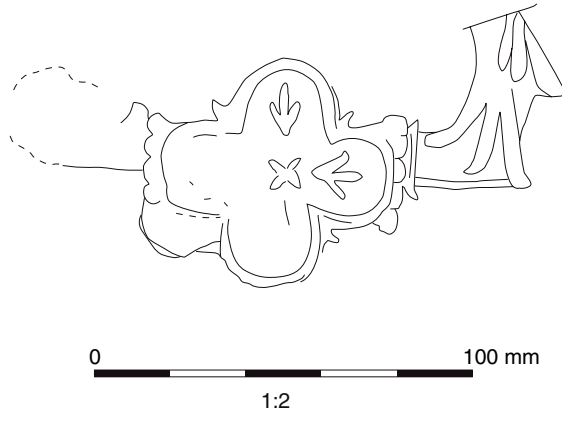

Figure 18: Outline drawing of Grip 60