



# Land off Crewe Road, Basford West, Crewe, Cheshire

## Archaeological Evaluation



**Oxford Archaeology North**

March 2009

**Goodman Ltd, on behalf of Taylor  
Woodrow Property Co Ltd**

Issue No: 2008-09/927

OA North Job No: L10084

NGR: SJ 710530

**Document Title:** LAND OFF CREWE ROAD, BASFORD WEST, CREWE,  
CHESHIRE

**Document Type:** Archaeological Evaluation

**Client Name:** Goodman Ltd, on behalf of Taylor Woodrow

**Issue Number:** 2008-09/927

**OA Job Number:** L10084

**National Grid Reference:** SJ 710530

**Prepared by:** Sean McPhillips  
**Position:** Project Officer  
**Date:** March 2009

**Checked by:** Emily Mercer  
**Position:** Project Manager  
**Date:** March 2009

**Approved by:** Alan Lupton  
**Position:** Project Manager  
**Date:** March 2009

Signed.....  

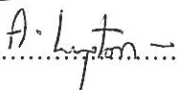
Signed.....  

**Oxford Archaeology North**

Mill 3  
Moor Lane  
Lancaster  
LA1 1GF  
t: (0044) 01524 848666  
f: (0044) 01524 848606

w: [www.oxfordarch.co.uk](http://www.oxfordarch.co.uk)  
e: [info@oxfordarch.co.uk](mailto:info@oxfordarch.co.uk)

**© Oxford Archaeological Unit Ltd (2009)**

Janus House  
Osney Mead  
Oxford  
OX2 0EA  
t: (0044) 01865 263800  
f: (0044) 01865 793496

Oxford Archaeological Unit Limited is a Registered Charity No: 285627

**Disclaimer:**

*This document has been prepared for the titled project or named part thereof and should not be relied upon or used for any other project without an independent check being carried out as to its suitability and prior written authority of Oxford Archaeology being obtained. Oxford Archaeology accepts no responsibility or liability for the consequences of this document being used for a purpose other than the purposes for which it was commissioned. Any person/party using or relying on the document for such other purposes agrees, and will by such use or reliance be taken to confirm their agreement to indemnify Oxford Archaeology for all loss or damage resulting therefrom. Oxford Archaeology accepts no responsibility or liability for this document to any party other than the person/party by whom it was commissioned.*

---

## CONTENTS

---

<b>SUMMARY</b> .....	<b>3</b>
<b>ACKNOWLEDGEMENTS</b> .....	<b>5</b>
<b>1. INTRODUCTION</b> .....	<b>6</b>
1.1 Circumstances of the Project.....	6
1.2 Site Location, Geology and Topography .....	6
<b>2. METHODOLOGY</b> .....	<b>7</b>
2.1 Project Design .....	7
2.2 Evaluation Trenches.....	7
2.3 Finds.....	8
2.3 Paleoenvironmental Sampling.....	8
2.4 Archive.....	8
<b>3. BACKGROUND</b> .....	<b>9</b>
3.1 Archaeological and Historical Background .....	9
3.2 Cartographic Development Of The Site.....	12
<b>4. EVALUATION RESULTS</b> .....	<b>17</b>
4.1 Introduction .....	17
4.2 Trench 1 .....	17
4.3 Trench 2 .....	19
4.4 Trench 3 .....	20
4.5 Trench 4 .....	22
4.6 Trench 5 .....	23
4.7 Trench 6 .....	25
4.8 Finds.....	27
<b>5. PALAEOENVIRONMENTAL RESULTS</b> .....	<b>28</b>
5.1 Introduction .....	28
5.2 Methodology.....	28
5.3 Results.....	29
5.4 Interpretation and Discussion.....	31
5.5 Soil Micromorphology.....	32
<b>6. DISCUSSION</b> .....	<b>35</b>
6.1 Introduction .....	35
6.2 Phase 1 (c 1500-1800) .....	35
6.3 Phase 2 (1800-2008).....	36
<b>7. IMPACT AND RECOMMENDATIONS</b> .....	<b>37</b>
7.1 Impact .....	37
7.2 Recommendations.....	37
<b>8. BIBLIOGRAPHY</b> .....	<b>38</b>
8.1 Cartographic Sources.....	38
8.2 Secondary Sources.....	38
<b>APPENDIX 1: PROJECT DESIGN</b> .....	<b>42</b>

---

<b>APPENDIX 2: CONTEXT LIST.....</b>	<b>51</b>
<b>APPENDIX 3: FINDS CATALOGUE.....</b>	<b>52</b>
<b>ILLUSTRATIONS .....</b>	<b>53</b>
List of Figures .....	53
List of Plates .....	53



---

## SUMMARY

---

Goodman Ltd, acting on behalf of Taylor Woodrow Property Co Ltd, commissioned Oxford Archaeology North (OA North) to undertake an archaeological evaluation at land off Crewe Road, Basford West, Crewe, Cheshire. The site is proposed for redevelopment as warehousing and distribution, manufacturing and light industrial/office use and associated ancillary works (planning application reference P03/1071). Crewe and Nantwich Borough Council has granted planning permission with a condition requiring a programme of archaeological evaluation based on the results of a geophysical survey undertaken predetermination (GSB 2003), following an archaeological desk-based assessment carried out in 2002 (OA North 2002). It is possible that archaeological remains associated with a medieval or post-medieval agricultural landscape may be affected by the proposed development. Therefore, in order to establish the nature and extent of any buried remains, and inform any requirement for mitigation, OA North carried out the archaeological evaluation in November 2008.

The evaluation comprised the excavation of six trenches across the development site. Four of the trenches measured 20m by 1.6m, and targeted anomalies of archaeological potential identified from the geophysical survey (GSB 2003). The remaining two trenches measured 9m and 6m long and were positioned over the historical township boundary dividing Shavington-cum-Gresty and Basford in order to investigate its date of construction and formation. The trenches were positioned in accordance with a verbal brief provided by Mark Leah, Cheshire County Council's (CCC) Archaeological Officer (Development Control).

The relict agricultural landscape, identified from previous archaeological work, is believed to date to at least the medieval period. This is supported by documentary evidence for medieval settlement in the area, although the extant town boundary between Shavington-cum-Gresty and Basford is also thought to be medieval in origin. However, evidence for any archaeological remains in Trenches 1-4 was limited; the only remains included traces of chert from the subsoil **101** in Trench 1, which was sealed by humified plough-soil **100** containing material dating from possibly as early as the fifteenth century, in addition to a line of probable modern fence posts (**402**, **404**, **406**) in Trench 4. The trenches through the township boundary, Trenches 5-6, revealed a substantial bank surviving up to 1.3m high, lined along its western side with a putative ditch.

The presence of known prehistoric finds spots close to the south-eastern and south-western parts of the development site may be indicative of earlier activity in the wider locality. However, the earliest evidence retrieved from the evaluation was a piece of medieval pottery, of at least fifteenth century date. No evidence for the date of construction of the township boundary bank and ditch was ascertained during the trenching either. The results of micromorphological assessment suggested that the *in situ* post-depositional soil formation may imply a long period of use, and the pollen content suggested that the surrounding land was mainly pasture when the ditch was being recut during the on-going maintenance. Any sign of arable activity in the area was not noted until late in the pollen sequence when the ditch was becoming infilled.

Rural settlement and landuse in the early medieval and the medieval periods is poorly studied and understood in the North West (Brennan *et al* 2007), and, therefore, identification of the boundary banks and ditch in Trenches 5 and 6, and any possibility of dating of the buried deposits from this boundary is significant. Radiocarbon dating suitable material from the ditch fill could provide some indication of date as to when it went out of use. Furthermore, to understand the boundary formation further four thin sections could be used to investigate the bank deposits and the boundaries between them (three from Trench 5 and one from Trench 6).

---

## ACKNOWLEDGEMENTS

---

Oxford Archaeology North (OA North) would like to thank Paul Heslop of Goodman Ltd for commissioning the project, Katy Reade of Middlemarch Environmental Ltd for the ecological information supplied, and to Mark Leah the Archaeological Officer for Cheshire County Council for his advice and support.

Thanks are also due to Elizabeth Huckerby, OA North environmental manager, who visited the site in order to provide advice on the extraction of soil monoliths through the township boundary. OA North would like to thank the geography department of Lancaster University for the use of their laboratories. Sandra Bonsall prepared the pollen and environmental samples. Sandra Bonsall and Elizabeth Huckerby assessed the plant remains and Elizabeth assessed the pollen. Dr Richard I Macphail, Institute of Archaeology, University College London, assessed the soil micromorphology.

The evaluation was directed by Sean McPhillips, who was assisted by Mark Oldham and Dave Shaw. The report was compiled by Sean McPhillips, whom also assessed the finds. Ann Stewardson produced the drawings, and the report was edited by Emily Mercer, who was also responsible for project management.

---

## 1. INTRODUCTION

---

### 1.1 CIRCUMSTANCES OF THE PROJECT

1.1.1 Goodman Ltd, acting on behalf of Taylor Woodrow Property Co Ltd, commissioned Oxford Archaeology North (OA North) to undertake an archaeological evaluation at land off Crewe Road, Basford West, Crewe, Cheshire. The site is proposed for redevelopment as warehousing and distribution, manufacturing and light industrial/office use and associated ancillary works (planning application reference P03/1071). The local planning authority, Crewe and Nantwich Borough Council, has granted planning permission with a number of conditions; condition 24 has requested a programme of archaeological evaluation based on the results of the geophysical survey undertaken predetermination (GSB 2003), following an archaeological desk-based assessment carried out in 2002 (OA North 2002), together with an archaeological investigation of the parish boundary. It is possible that archaeological remains associated with a medieval or post-medieval agricultural landscape may be affected by the proposed development. Therefore, in order to establish the nature and extent of any buried remains, and inform any requirement for mitigation, OA North carried out the archaeological evaluation in November 2008. This report sets out the results of this evaluation.

### 1.2 SITE LOCATION, GEOLOGY AND TOPOGRAPHY

1.2.1 The study area lies near to the village of Basford, 3km to the south of Crewe, Cheshire (centred on NGR SJ 708 532; Fig 1). The site is situated within the Cheshire Plain, which extends from the broad Mersey Valley in the north, to the Shropshire Hills in the south. To the west, the Cheshire Plain is bounded by the hills of the Welsh borders, and to the north-east are the Pennine foothills (Countryside Commission 1998, 145). Much of the Plain is gently undulating, with only slight changes in elevation between 20m and 50m OD. The predominant land use is the production of grass for grazing, silage or hay, although the farming is more mixed in the southern parts, and meres and mosses are widespread local features (*ibid*). Those within proximity to the study area include Oakhanger Moss and White Moss to the north-east, Wybunbury Moss to the south, and Baddiley Mere to the south-east (Leah *et al* 1997, 15).

1.2.2 The solid geology of the Cheshire Plain is formed from Triassic sandstones and marls, but these are overlain by glacial deposits, largely consisting of boulder clay, with local deposits of silt, peat, sand and gravels (Countryside Commission 1998, 149; OS Soil Survey 1983).

---

## 2. METHODOLOGY

---

### 2.1 PROJECT DESIGN

2.1.1 OA North were requested to prepare a project design in accordance with a verbal brief, subsequent to a letter dated 4 December 2003 issued by Mark Leah, Cheshire County Council's (CCC) Archaeological Officer (Development Control) (AO) (*Appendix 1*). The project design was prepared in accordance with the Cheshire County Council guidelines (2003), and consistent with the relevant standards and procedures of the Institute of Archaeologists (1994, 1999) and English Heritage (1991), as generally accepted best practice, and in line with PPG 16 (DoE 1990).

### 2.2 EVALUATION TRENCHES

2.2.1 In total, six trenches of varying sizes were excavated within the outlined development area (Fig 2). These focussed on two elements; four trenches were excavated, each measuring 20m long by 1.6m wide, targetting areas containing anomalies of possible archaeological potential (GSB 2003); and two trenches measuring 9m and 6m long across the historical township boundary between Basford and Shavington-cum-Gresty. These lengths were determined on-site by the survival of the earthwork, including bank and ditch. Collectively, the investigation aimed to record any buried soil horizons, and assess and date any significant deposits. The uppermost levels of each trench were excavated by a machine fitted with a toothless ditching bucket. The same machine was then used to define carefully the extent of any deposits and other remains, thereafter all excavations were undertaken manually. All deposits were levelled and related to the Ordnance Datum and Ordnance Survey.

2.2.2 All information was recorded stratigraphically with accompanying documentation (plans, sections, and both colour slide and monochrome print photographs, both of individual contexts and overall site shots from standard view points). Photography was undertaken with 35mm cameras on archivable black-and-white print film, as well as colour transparency, all frames including a visible, graduated metric scale. Digital photography was used extensively throughout the course of the fieldwork for presentation purposes. Photographic records were also maintained on special photographic *pro-forma* sheets.

2.2.3 The precise location of each trench was plotted prior to excavation using a Leica differential Global Positioning System (dGPS). Each trench was planned digitally by an experienced surveyor using dGPS to record structural remains and other buried features, locating them according to Ordnance Survey (OS) co-ordinates. The dGPS uses real-time corrections (RTK) using mobile SmartNet technology to achieve an accuracy of approximately  $\pm 0.01$ m.

## **2.3 FINDS**

- 2.3.1 Finds' recovery and sampling programmes were carried out in accordance with best practice (following current Institute of Archaeologists guidelines), and subject to expert advice in order to minimise deterioration. All artefacts recovered from the evaluation trenches were retained.

## **2.4 PALAEOENVIRONMENTAL SAMPLING**

- 2.4.1 A targeted programme of palaeoenvironmental sampling was implemented in accordance with the Oxford Archaeology Unit *Environmental Guidelines and Manual* (OAU 2005), and in line with the English Heritage guidance paper on Environmental Archaeology (2001). In general, one bulk sample measuring 10 litres, and four monoliths (Figs 7 and 9) were taken where appropriate, to be sub-sampled at a later stage.

## **2.5 ARCHIVE**

- 2.5.1 The results of all archaeological work carried out will form the basis for a full archive to professional standards, in accordance with current English Heritage guidelines (*Management of Archaeological Projects*, 2nd edition, 1991). The original record and digital archive of the project will be deposited with the Cheshire Record Office, Chester.
- 2.5.2 The Arts and Humanities Data Service (AHDS) online database *Online Access to index of Archaeological Investigations* (OASIS) will be completed as part of the archiving phase of the project.

---

### 3. BACKGROUND

---

#### 3.1 ARCHAEOLOGICAL AND HISTORICAL BACKGROUND

- 3.1.1 **Introduction:** the following background allows the site to be considered within the wider historical and archaeological context when assessing the potential for archaeological remains, and has been taken from a desk-based assessment compiled by Oxford Archaeology North (OA North 2002).
- 3.1.2 **Palaeolithic and Mesolithic Periods (up to 3000 BC):** the earliest evidence for human occupation in Cheshire dates to the Mesolithic period, although most of the evidence for such activity is confined to the Pennine fringes in the eastern part of the county. Some evidence for activity closer to the site during the Mesolithic period, however, is attested from surface finds. Such artefacts include a flint trimming flake, an unworked flint blade of early prehistoric date, and a black chert trimming flake of Mesolithic date (Leah *et al* 1997, 127), although there is little direct evidence for the nature of any activity during this period.
- 3.1.3 **Neolithic and Bronze Age Periods (3000 - 600 BC):** the Neolithic period is generally associated with the beginnings of agriculture and settled communities, and whilst few sites of this date have yet been identified in Cheshire, indications of clearance and vegetational changes have been identified in the pollen record (Leah *et al* 1997). Supporting evidence for Neolithic activity is confined to surface finds, most of which consist of isolated flint tools found during fieldwalking; the occasional examples of stratified deposits which have been excavated have been found fortuitously on excavations of later sites (Higham 1993). A particularly fine example of such a tool was a flint dagger recorded as a surface find from the Basford area (Longley 1987, 79). This tool was notched at the base of the blade, which was fashioned from grey flint, and reflected the form of early metal blades of later Beaker associations. Several single-struck flints were also recovered from the vicinity of Weston Hall during the North West Wetlands Survey of Cheshire in 1997 (Leah *et al* 1997), and a group of five worked flints, including a double-ended scraper, a core, and an unretouched flake of late prehistoric date, have been retrieved (*op cit*, 128).
- 3.1.4 The Early Bronze Age shows a similar pattern with most of the evidence for settlement being confined to funerary monuments on the Pennine fringes. Increasing pressure on the available agricultural land later in the Bronze Age may have been the cause of the construction of defensive earthworks in upland areas such as the mid-Cheshire Ridge, although the associated agricultural settlements remain elusive (Adams 2000).
- 3.1.5 **Iron Age Period (600 BC - AD43):** the area surrounding the site is situated within the area believed to have been occupied by the *Cornovii* (Webster 1975), and it has been suggested that the various Iron Age enclosures along the mid-Cheshire ridge may be a northwards extension of the Iron Age



hillforts above the North Shropshire Plain (Leah *et al* 1997, 152). This activity may, in part, correspond with the palaeoenvironmental record, which shows a general intensification in landscape use across much of the county during the Iron Age (*ibid*); however, with the exception of these enclosures, the evidence for settlement during this period is for the most part limited to chance finds. These include the bog body from Lindow Moss, which has provided invaluable information about the period (Stead *et al* 1986; Turner and Scaife 1995). Whilst there is, as yet, little direct evidence for salt production or for any associated settlements from this period, the brine springs of central and southern Cheshire are known to have been the focus of a well-established Iron Age salt industry (Morris 1985), and the production of a characteristic type of Iron Age pottery (VCP (Very Coarse Pottery)) has been linked to the salt trade.

- 3.1.6 **Romano-British Period (AD43 - 410):** the Roman period is well represented within Cheshire, although until recently most research has concentrated upon urban and military sites, with few investigations of rural settlements having been undertaken. Analysis of aerial photographs in recent years has identified numerous small enclosures thought to represent rural settlements, and the few that have been excavated have all dated to the Roman period (Nevell 1991).
- 3.1.7 The evolution of the Cheshire salt industry, which is focused in the central and southern parts of the county and appears to have been developed by the Roman administration, is of particular interest. The prosperity of Middlewich, for instance, was probably based entirely upon the salt trade (Higham 1993). The discovery of five Roman lead salt-pans at Northwich in August 1864 suggested that salt was being manufactured outside the area of the fort (Penney and Shotter 1996). Similarly, Watkin (1886) reported a brine kiln and briquetage some three miles from Middlewich, presumed to be of a Roman date, and the discovery of briquetage from Railway Farm, Moston (Price 1994), again indicates that the Roman salt industry extended into rural locations some distance from known centres of Roman settlement. Recent finds of salt pan fragments from the Shavington area (Penney and Shotter 1996), moreover, not only suggest that rural sites may have played a role in this trade, but are also consistent with the existence of Roman salt production in the immediate vicinity.
- 3.1.8 The precise location of the nearest section of Roman road to the site is uncertain, although O'Dwyer (1935) noted that it ran between Crewe Green and Weston, a line some 3km to the east of the site. This road ran due south from the Roman fort at Middlewich, situated 12km north of the site. Margary (1957) also identified a well-established Roman road that proceeded from Middlewich on a south-westward alignment. Definite remains of this road occur at Wood Farm, Worleston, located 4km north-east of the site (*ibid*).
- 3.1.9 **Early Medieval Period (AD410 - 1066):** there is little information available pertaining to the early medieval period; only six Cheshire places are mentioned in the *Anglo-Saxon Chronicle*, the chief source of the general history of the period (Sylvester 1971). Indeed, studies of rural archaeology of this period are bedevilled by the same problems of site visibility as the earlier periods (Adams 2000). The only excavated rural site which may belong to this



period is Tatton (Higham 1993). Most of the evidence for post-Roman settlement in this area is based upon studies of place-names, which, in general terms, suggest a mixture of native British and Saxon speakers (Gelling 1992, 62), whilst the suffix of *-ton* in Shavington and Weston suggests that they were probably in existence by the end of the eighth century (Sylvester 1971, 24). The Basford Tithe Map of 1839 (CRO/EDT 41/2), moreover, shows that the majority of older field names in Shavington are of likely Anglo-Saxon origin.

- 3.1.10 **Medieval Period (AD1066 – 1485):** in general terms, the rural landscape of Cheshire during the medieval period would have been occupied by a series of small nucleated villages surrounded by open fields (Sylvester 1971). Whilst there were small scattered settlements in south Cheshire between the Weaver and the Dee, the situation during the late eleventh century further east is uncertain; Haworth and Comber (1952) claim that Shavington was waste land by the time of the Domesday Book (1086) (Morgan 1978). An agricultural economy will have been established during the latter part of this period, however, and in Wybunbury, for instance, a three field system of ploughing was followed in the thirteenth century (*ibid*). This type of system does not, however, appear to be typical in Cheshire, which seems to have evolved an irregular system in which fields were of different sizes, and were rarely three in number. More usual were the one- or two-field townships (Sylvester and Nulty 1958).
- 3.1.11 During this period, the site was divided between the townships of Basford and Shavington. These lay within the parish of Wybunbury, which formed part of a group of large Cheshire parishes associated with important ecclesiastical centres (Thacker 1987), which probably also had an administrative function. Wybunbury appears in the Domesday Book as *Wimeberie* (Morgan 1978). Basford is first mentioned in the Domesday Book, where it appears as *Berchesford* (*ibid*). Basford Hall was the seat of the Bromleys, and was a timbered mansion, surrounded by a moat, that was destroyed by fire about 1700 (*ibid*). Shavington is also mentioned in the Domesday Book, where it is thought to appear under the name of *Santune* (Haworth and Comber 1952). The name originates from the Old English personal name *Scaefa*, hence ‘farm called after *Scaefa*’ (*ibid*).
- 3.1.12 In the Hunsterson township of the same parish, to the south of the development site, it has been noted by Sylvester (1956 cited in Brennan 2006, 100) that two adjacent oval enclosures define the extent of the arable land thought to be medieval but undated. The historical boundary between the townships of Shavington-cum-Gresty is marked presently by a hedgerow.
- 3.1.13 **Post-Medieval Period (AD1485 – 1901):** the Tudor and Stuart period may be regarded as the heyday of the small manor house, and nowhere were they more important than in Cheshire, ‘the seedpot of gentility’ (Sylvester 1971). The great bulk of the population drew at least part of their income from the land during this period (Phillips and Smith 1994), and the area is likely to have retained its rural character until well into the nineteenth century (Adams 2000); villages such as Weston and Basford have probably remained largely unaltered in their general layout since the end of the Middle Ages. The major

change to the landscape prior to the Industrial Revolution would have been the enclosure of the medieval open field system, and by the early nineteenth century, only vestiges of the former open arable fields of the county survived (Sylvester and Nulty 1958); the fields within the site are shown as enclosed on nineteenth century maps and, whilst field boundaries are not shown on Burdett's map of 1777 (Plate 1), it is unlikely that an open field system of agriculture was practised at that time. The process of enclosing, that is fencing off an individual's land from that of his neighbours, had begun in the medieval centuries. Parliamentary Enclosure in Cheshire began around 1765, although this had minimal impact until the late eighteenth and early nineteenth centuries (Phillips and Smith 1994).

- 3.1.14 The practice of marling limestone, excavated for use as a fertiliser or building material, was introduced during the Roman period, and continued in Cheshire throughout the medieval period (Fussell 1955). Commercial peat production, which began in the late nineteenth century in Cheshire and agricultural improvements (Leah *et al* 1997, 215), effected changes to the wetlands in the region, although there are no mosses within the site.
- 3.1.15 Development of the area from the mid-nineteenth century onwards was dominated by the expansion of the railway industry, centred on the town of Crewe. This expansion included the construction of the Basford Hall Sorting Sidings across the eastern edge of the site, which resulted in the modification of some field boundaries (Plate 3).
- 3.1.16 The rise of a formal retail market in Crewe began in 1842, when four railway lines converged there and the Grand Junction Company established its engine sheds and repair shops (Phillips and Smith 1994, 164). With the opening of Crewe Works in 1843, Crewe became a boom town. Farmers in Shavington found that men were leaving the land in increasing numbers to find work in Crewe (Nulty 1959), and the evidence obtained from the trade directories indicates that Basford is likely to have experienced a similar phenomenon. A new station was erected at Crewe in 1867 to replace the original structure of 1846, and about 50 acres of land along the line from Shavington to Crewe, including some within the site, were bought for increased accommodation for goods traffic (*ibid*). Continued expansion, based largely on the railway industry, led to the designation of Crewe as a borough in 1877 (Scholes 2000). Diversification from the railway industry was achieved in the twentieth century with the arrival of Rolls Royce Aero Engines in 1938 and after the Second World War, Rolls Royce based its automobile engineering division at Crewe (*ibid*).

## 3.2 CARTOGRAPHIC DEVELOPMENT OF THE SITE

- 3.2.1 The cartographic sources used during the desk-based assessment (OA North 2002) were re-examined, in order to identify the potential for archaeological remains against the proposed construction. Only those sources of relevance to the evaluation are included below.

- 3.2.2 *Burdett's Map of Cheshire 1777*: this is a map of the settlements of the county of Cheshire, showing their relative locations and distinguishing some as more prominent than others. It also depicts areas of woodland and heath, and gives an impression of the density of occupation. This map clearly shows Shavington-cum-Gresty, Basford, and Weston, together with Crewe, Basford, and Weston Halls. It also shows the position of the roads and tracks in the area, but does not depict the field boundaries. The stepped dotted line running northwards between Shavington and Basford is the township boundary targeted during the evaluation.



Plate 1: Burdett's Map of Cheshire, 1777



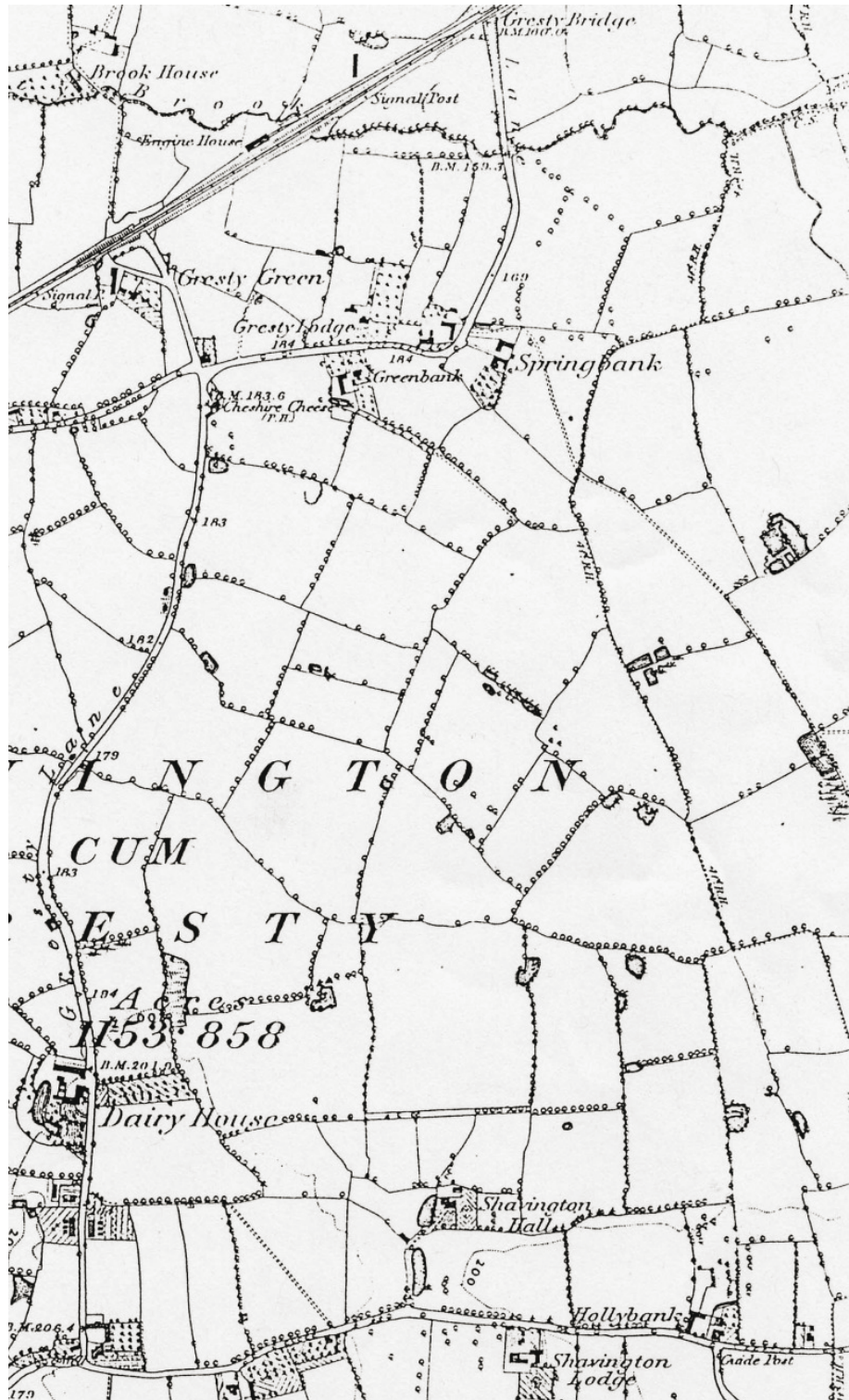

Plate 2: Tithe Commutation Map, c 1839 – Township of Shavington

- 3.2.3 *Tithe Commutation Map, c 1839 – Township of Shavington (CRO/EDT 353/2)*: this map provides a detailed survey of the site, showing the land holdings in the township of Shavington. It shows roads and field names which correspond to those in the Apportionment.



Plate 3: Ordnance Survey 1876, 1st Edition 6":1 mile

3.2.4 **Ordnance Survey 1876 – 1st Edition 6":1 mile:** this map is very similar to the tithe map (Plate 2), although it shows more development along Gresty Lane to the west and the new Crewe sorting sidings to the east. Comparison of this map with the current Ordnance Survey 1:10,000 map shows the gradual amalgamation of fields through the late nineteenth and twentieth centuries,



although only six boundaries appear to have been removed, with a reduction in the number of fields within the site from 30 to 22.

- 3.2.5 ***Ordnance Survey map of 2006 (not shown)***: this map shows the site as enclosed fields with further road development with the southern part of the site bounded by the A500.

---

## 4. EVALUATION RESULTS

---

### 4.1 INTRODUCTION

- 4.1.1 In total, four trenches (Trenches 1-4) each measuring 20m long, and two trenches (Trenches 5 and 6) measuring 9m and 6m long respectively (totalling 95m in length) were excavated across the site (Fig 2). A full list of excavated contexts is listed in *Appendix 2* and the finds are discussed in *Section 4.5* and listed in *Appendix 3*.
- 4.1.2 The depth of the trenches varied between 0.5m and 1.4m, onto the surface of natural geological horizons. The topsoil in each trench was largely absent, having been removed prior to the evaluation as part of remedial work undertaken by ecological contractors. Other than in Trenches 5 and 6, which were excavated through the former historical boundary between the townships of Shavington-cum-Gresty and Basford, no remains of archaeological significance were encountered. As such, only two phases of activity were identified spanning the post-medieval to modern periods from the eighteenth to twentieth centuries. Although no archaeological features representing earlier occupation was recognised, it cannot be discounted. This is suggested by known prehistoric finds spots close to the south-eastern and south-western parts of the study area, and the township boundary, which is of uncertain date. However, artefactual fragments recovered from the excavation suggests that there was little occupation prior to the eighteenth century.
- 4.1.3 There was a paucity of finds collected from the evaluation, which is perhaps to be expected given the suggested lack of human activity in the area. However, the lack of artefacts within the remains of the topsoil, suggested that the land was not used for deep ploughed cultivation.

### 4.2 TRENCH 1

- 4.2.1 The trench was aligned north-east/south-west positioned on the western part of the site (Fig 2, Plate 4), in the field immediately to the rear of a row of houses along the eastern side of Crewe Road. Its position was determined by data generated from the archaeological assessment (OA North 2002), which identified a large depression in the northern edge of the field, filled with low mounds that may be the result of mineral extraction. In addition, the geophysical survey (GSB 2003) identified a possible pit of archaeological potential, which maybe associated with similar workings. No evidence of quarrying was identified in the trench, although the high humic content of the topsoil suggested that the land was arable and potentially used for ploughing. The trench was excavated to a maximum depth of 0.75m onto the surface of firm yellow-red clay (**102**) forming a natural geological horizon. A plan of the trench is shown graphically as Figure 3.



Plate 4: View of Trench 1, looking north

- 4.2.2 The overlying dark-grey topsoil (**100**), measured 0.4m in thickness, and contained fragments of pottery and clay pipe that have a date range between the fifteenth and nineteenth centuries. Although the full thickness of the topsoil was not ascertained due to the removal of the upper deposit by the ecological contractors, its formation perhaps demonstrated that the land had been cultivated prior to the possible mineral extraction at the northern end of the field (Plate 5). The topsoil, **100**, overlay loose red clay subsoil, **101**, containing infrequent small chert fragments, although none appeared worked. This layer was spread evenly across the trench and measured 0.3m in thickness, with evidence of water saturation observed near to the base of the deposit at 0.4m beneath the present ground surface. This overlay natural clay layer **102**. The trench was devoid of archaeological features or deposits.





Plate 5: East-facing section through Trench 1, showing remnants of possible ploughsoil **100**

### 4.3 TRENCH 2

- 4.3.1 This trench was located within the western part of the site, aligned east/west (Fig 2, Plate 6). It was positioned over linear features identified in the geophysical survey as being of possible archaeological potential, possibly a relict field boundary that was identified during the walkover survey in 2002 (OA North 2002). It was also in close proximity to a series of ridge and furrow earthworks (*ibid*). It was excavated to a depth of 0.5m. The remains are shown graphically as Figure 4.
- 4.3.2 The stratigraphy in the trench comprised a 0.1m thick mid grey clay forming the remains of the topsoil **203**. This contained a fragment of melted glass and a sherd of hand-painted pottery dated to the eighteenth or nineteenth century. This sealed a thin dark grey clay subsoil **202**, measuring 0.15m thick, which probably represented buried topsoil. This overlay the natural geological clay horizons **200** and **201**. These were a distinctive yellow (**200**) and orange (**201**) colour, thus representing two distinct natural geological horizons. No evidence of the field boundary or ridge and furrow was observed within the topsoil, **203**, or subsoil, **202**, deposits.
- 4.3.3 No significant archaeological intervention was encountered, although fragments of a north-west/south-east aligned ceramic land drain (**205**) was observed cutting clay **201** at the western end of the trench. Other remains included a 0.25m diameter animal burrow (**204**).



Plate 6: View of Trench 2, looking east

#### 4.4 TRENCH 3

- 4.4.1 This trench was aligned north-west/south-east along the northern side of an extant pond (Plate 7), and positioned a short distance north-west of Trench 2 (Fig 2). Its location was based on the results of the geophysical survey (GSB 2003), which recorded the presence of several ditch type features aligned north-east/south-west across the field, and a visible hollow (OA North 2002) within the central area of the field. The trench was originally intended to cross this hollow, although this was not possible at the time of evaluation as it was filled with water (Plate 7). No archaeological features or deposits were encountered, although fragments of post-medieval pottery were recovered from the topsoil (300). The trench was excavated to a maximum depth of 0.9m through light brown-red clay (301) within a sondage at the southern end of the trench (Plate 8). This was excavated in order to characterise the apparent change in the natural geological horizon, similar to that observed in Trenches 1 and 2. The remainder of the trench was excavated to a maximum depth of 0.6m beneath the remnants of topsoil.





Plate 7: View of the extant pond, formerly identified as a hollow, looking east

- 4.4.2 A 0.08m thick deposit of mid grey-brown clay topsoil, **300**, containing fragments of pottery dating to the late eighteenth and nineteenth century sealed a 0.52m thick yellow-red firm clay, **301**, spread evenly across the trench, containing occasional fragments of iron stone. No features of archaeological significance were encountered in the trench.



Plate 8: View of Trench 3, looking west

#### 4.5 TRENCH 4

- 4.5.1 This trench was aligned north/south, positioned along the north-eastern part of the site close to the boundary surrounding the railway sidings (Fig 2, Plate 4). Its location was determined from the data generated from the geophysical survey (GSB 2003), which identified a number of anomalies suggesting the possibility of pits of archaeological potential. It was positioned outside of the area of concern for the ecological contractors, being a later phase of the development, and so retained the turf and topsoil undisturbed (Plate 9). It was excavated to a maximum depth of 0.3m. The remains are shown graphically as Figure 5.
- 4.5.2 The stratigraphy comprised a 0.3m thick turf and topsoil (**400**), comprising a dark grey brown sandy-clay containing occasional small stones. No visible subsoil was encountered beneath the topsoil or overlying the yellow clay (**401**, Plate 9) representing a geological deposit. This was cut by a row of three postholes (**402**, **404** and **406**), which possibly formed part of a former fence line.



Plate 9: View of Trench 4, looking north-east

- 4.5.3 The postholes were set a distance apart of 2m, aligned north/south along the western side of the trench. They cut into clay deposit **401** to a maximum overall depth of 0.2m. Each posthole measured approximately 0.35m-0.4m in diameter, with steep edges, that gradually sloped onto a slight concave base.



Their fills (**403**, **405** and **407**) comprised dark brown-grey loamy clay with no visible inclusion other than occasional stones. No packing was observed nor any inclination of axis, suggesting that the posts may have been driven in mechanically. The alignment of the features suggested that they possibly formed a temporary field division, although firm identification was difficult to ascertain from the lack of dateable artefacts.

## 2.3 TRENCH 5

- 4.6.1 This trench was positioned across the township boundary bank and ditch, in the eastern central part of the proposed development site (Plate 10). The intention was to obtain a profile of the earthwork, and possibly ascertain evidence of its formation, although a full section was not possible due to the close proximity of a newt fence along the eastern side of the site. It was aligned east/west, measured 6m in length and 1.8m wide. It was excavated to a maximum depth of 1.4m. Remains of the bank and ditch are shown graphically in plan as Figure 6, and a section through the earthwork is shown in Figure 7.
- 4.6.2 This section of the boundary was relatively well-preserved, although it was clear that part of the accumulated topsoil overlying the bank had been extensively removed during the hedgerow clearance. This had also removed evidence of the hedgerow formation, as few roots survived within the bank make-up, although the ditch, **500**, contained the root from a large tree.



Plate 10: North-facing section through Trench 5, positioned on the township boundary between Shavington-cum-Gresty and Basford

- 4.6.3 Overlying the boundary bank and ditch was a dark brown friable silty-clay forming the topsoil **501**. This survived for a thickness of 0.15m above the

bank, gradually thickening to 0.25m above ditch **500** (Fig 7). It contained frequent small roots, with occasional larger roots measuring up to 0.08m in diameter

- 4.6.4 The exposed bank measured 1.5m wide and survived to a height of 0.9m. It was formed by a light brown clay (**502**) measuring up to 0.5m in thickness. Its relatively loose texture was probably the result of bioturbation from overlying plant roots. Clay **502** sealed a more compacted clay **503**, which comprised a light orange-brown clay with occasional lenses of sand and sandstone, which measured 0.3m in thickness. This sealed the grey-brown clay deposit **504** that formed part of a natural geological horizon beneath the bank, at the eastern side of the trench. The natural clay **504** at the western end of the trench, beyond ditch **500**, was 0.64m deep. It is worth noting that very few stones were observed within the bank, normally used to provide stability, although the hard compaction of the clays suggested that the use of other material was not required, or perhaps were not readily available.



Plate 11: North-facing section through part of the bank in Trench 5, looking south along the line of the boundary



- 4.6.5 On the west side of the bank was a V-shaped ditch, **500**, beneath clay **502**. It measured 0.6m wide, and cut to a depth of 0.5m through clay **503** and **504**. It was filled with an organic mixture of dark brown silty-clay, **505**, and abundant root matter. The presence of tree roots suggested that its use as a ditch had been compromised, although its backfill may have been a relatively recent event.
- 4.6.6 There was no direct evidence of bank modification, although there was evidence of a recent ditch re-cut along the northern part of the site, required for drainage.

#### 4.7 TRENCH 6

- 4.7.1 This trench was placed east/west across the township boundary in the northern half of the development site. The trench position was determined in order to compare the condition of the boundary earthwork in the northern part of the site with the remains encountered in Trench 5. It measured 9.4m long (Plate 12), and was excavated to a maximum depth of 1.1m onto the surface of grey-brown clay (**604**) in the central part of the trench beneath the bank, and 0.3m at the western end. The formation of the earthwork was closely similar to that recorded in Trench 5 (see *Section 4.6*, above), although recording of the ditch was hindered due to a recent re-cut of the feature for drainage purposes through the western side of the trench. Remains of the bank and ditch are shown graphically in plan as Figure 8, and a section through the earthwork shown as Figure 9.



Plate 12: View of Trench 6, looking west

- 4.7.2 The bank was similar in formation and height as observed in Trench 5, although a full profile of the earthwork was not fully ascertained, due to partial removal of topsoil along the bank crest during recent hedgerow clearance. It measured a maximum width of 3.8m, and survived to a height of 0.75m. Its formation was similar to that seen in Trench 5, which was to be expected, i.e. an accumulation of clay deposits overlying a natural geological clay horizon.
- 4.7.3 The bank and ditch were sealed by the remnants of the topsoil, **600**, between 0.1-0.15m thick (Fig 9), which undulated over the earthwork. This contained a large amount of tree roots representing the vestiges of the hedgerow and trees before clearance by the ecologists. This sealed a 0.1m thick deposit of light brown clay, **601**, which possibly represented a buried soil horizon. This overlay a mid-brown firm clay, **602**, measuring up to 0.35m in thickness, which was spread thinly at the eastern end of the trench and gradually thickened over the main part of the bank. Beneath this was a 0.15m thick band of firm yellow clay, **603**, containing occasional lenses of small degraded sandstone lumps, similar to **503** in Trench 5 and observed for a distance of at least 4m forming the basal deposit of the bank. The underlying natural geological horizon was clay **604** that sloped gently to the west, along a slight gradient measuring approximately 30°.



Plate 13: South-facing section through the township boundary showing the disturbed ditch **605**, looking north-east

- 4.7.4 The bank clay layers were cut in the west by a 0.8m wide ditch, **605**, which was part of a re-cut associated with an attempt to alleviate flooding (Frizells machine operator pers comm). Traces of the original ditch, however, survived at the base of the re-cut in the form of a sharp 45° angled slope forming the eastern side of the cut, and a shallower 30° angled slope in the west. This was cut into the top of clay **604**. The overall width of the original ditch was not ascertained, although it is probable that it was V-shaped. It was filled with a mixture of organic matter and silty-clay, **606**, measuring 0.3m in depth.



## 4.8 FINDS

- 4.8.1 **Introduction:** in total, a small assemblage of nine artefacts were collected from topsoil deposits within Trenches 1 (**100**), 2 (**203**) and 3 (**300**). These included six fragments of pottery, two clay tobacco pipe stems, melted glass and a lump of unworked flint. Other than flint, the material has a broad date range between the fifteenth and nineteenth century.
- 4.8.2 **Pottery:** the pottery included a partially reduced greyish-blue fragment from an over-fired glazed jug waster recovered from topsoil **100** in Trench 1. A thumb-pressed scar on the exterior resembled the type of decoration common on Midlands Purple type wares, and is similar to examples recently recovered from seventeenth century deposits during excavations in North West England, such as Chorlton Fold farm (OA North 2008a) and Wharton Hall (OA North 2008b). Dating of Midlands Purple commonly falls between the fifteenth and seventeenth century, although it is possible that the Basford sherd may have a later date. The sherd was recovered with a small group of three eighteenth century sherds, including a thin-walled red sand-rich Blackware, and a Mottled ware bowl. The remaining sherds in the assemblage included two sherds of transfer-printed wares from Trenches 2 and 3, including a plate and a sugar bowl, which date to the nineteenth century.
- 4.8.3 **Clay tobacco pipe:** this category included two medium bore undecorated stems recovered from topsoil **100** in Trench 1. These are difficult to ascribe a date although they could broadly fall between the eighteenth and nineteenth century.
- 4.8.4 **Glass:** a small clear melted lump was recovered from topsoil **203**, recovered with nineteenth century pottery. No indication of glass working was evident.
- 4.8.5 **Flint:** a lump of unworked flint was collected from topsoil **100**. Although the fragment had a chipped exterior resembling a worked core, the quality of the stone is poor, and the chips were more than likely the result of weathering or from the effects of ploughing.
- 4.8.6 **Conclusion:** the small finds assemblage is of limited archaeological interest, and adds little to the interpretation of the site.

## 5. PALAEOENVIRONMENTAL RESULTS

### 5.1 INTRODUCTION

- 5.1.1 In order to understand the formation of the historic township boundary targeted by Trenches 5 and 6, and assess any potential for dating the deposits, four monolith samples were taken; Sample 1 from the embankment section in Trench 6 (Fig 9), Sample 2 from the truncated ditch (**500**) section in Trench 5, and Samples 3 and 4 from the embankment section also in Trench 5 (Fig 7). An additional environmental bulk sample (Sample 5) was taken from the fill (**505**) of the ditch (**500**) in Trench 5 for the analysis of charred and waterlogged plant remains.
- 5.1.2 The ditch sample, Sample 2, was assessed as to the potential for pollen and plant macrofossils by the OA North in-house environmentalists. The three boundary embankment samples, Samples 1, 3 and 4, have been assessed as to their potential for soil micromorphology by Dr Richard MacPhail (see *Section 5.5*).

### 5.2 METHODOLOGY

- 5.2.1 **Pollen:** Sample 2 was cleaned and noted for detail (Table 1, below). Four sub-samples were then taken for pollen assessment at depths of 0.4m-0.41m, 0.6-0.61m, 0.76-0.77m (**505**), and 0.83m-0.84m (**504**).

CONTEXT	DEPTH (M)	SEDIMENT TYPE
<b>505</b>	0.38-0.78	Organic deposit rich in wood fragments, clay content increasing with depth
<b>504</b>	0.78-0.88	Stiff orange clay

Table 1: Description of deposits from Sample 2, from the fill **505** of the boundary ditch **500** (see Fig 7)

- 5.2.2 Volumetric samples were taken from the four sub-samples and two tablets containing a known number of *Lycopodium* spores were added so that pollen concentrations could be calculated (Stockmarr 1972). The samples were prepared using a standard chemical procedure (Method B, Berglund and Ralska-Jasiewiczowa 1986) using HCl, NaOH, sieving, HF, and Erdtman's acetolysis, to remove carbonates, humic acids, particles >170 microns, silicates, and cellulose, respectively. The samples were then stained with safranin, dehydrated in tertiary butyl alcohol, and the residues mounted in 2000cs silicone oil. Slides were examined at a magnification of 400x (1000x for critical examination) by ten equally-spaced traverses, across at least two slides to reduce the possible effects of differential dispersal on the slides (Brooks and Thomas 1967). Pollen identification was made following the keys

of Faegri and Iversen (1989), Moore *et al* (1991), and a small modern reference collection. Andersen (1979) was followed for the identification of cereal grains. Indeterminable pollen was also recorded as an indication of the state of pollen preservation. Plant nomenclature follows Stace (1997). The preservation of the pollen was noted and an assessment was made of the potential for further analysis. Charcoal particles greater than five microns were recorded also (Peglar 1993).

- 5.2.3 The data are shown in Table 2 as percentage values of the pollen sum, which includes all land pollen and spores. Charcoal values are expressed as the percentage of the pollen sum plus the number of charcoal fragments.
- 5.2.4 **Charred and waterlogged plant remains:** a 10 litre bulk sample (Sample 5) was processed for the assessment of charred and waterlogged plant remains. The sample was hand-floated, the flot was then collected on a 250 micron mesh and air dried. The flot was scanned with a Leica MZ60 stereo microscope and the plant material was recorded and provisionally identified. The data are shown on Table 3. Botanical nomenclature follows Stace (1997). Plant remains were scored on a scale of abundance of 1-4, where 1 is rare (up to 5 items) and 4 is abundant (>100 items). The components of the matrix were also noted.

### 5.3 RESULTS

- 5.3.1 **Pollen:** abundant, well-preserved pollen was recorded in the fill, **505**, of ditch **500** but there were only occasional grains in the sample from the stiff orange natural clay, **504**. The relative percentages of tree and shrub (33-27%), of herbaceous (63-56%), and of ericales pollen (2-6%) and of fern spores (9-4%) suggest that the landscape was largely cleared when ditch **500** was infilling, although a hedgerow or some woodland was also present, possibly relating to the boundary hedgerow. The high values of grass (Poaceae) and ribwort plantain (*Plantago lanceolata*) pollen are indicative of widespread grassland/pasture or waste ground, and towards the top of the sequence there is evidence of possible arable cultivation when cereal-type pollen is recorded.
- 5.3.2 When the ditch (**500**) was first cut or when the fill (**505**) begun to accumulate, if it was initially regularly maintained and re-cut, alder (*Alnus glutinosa*) and hazel (*Corylus avellana*-type) trees were more frequent, but these were largely replaced towards the top of the sequence of the monolith sample by oak (*Quercus*) trees. A few grains of pollen from members of the rose (Rosaceae) family were recorded and this family includes blackberry (*Rubus fruticosus* agg) and hawthorn (*Crataegus monogyna*). Pollen from sloes/cherries (*Prunus*) was recorded in the upper sample.
- 5.3.3 The presence of alder pollen towards the base of the monolith sample from **505**, together with a grain of bulrush (*Typha latifolia*) suggest that conditions were wet, which is to be expected from a ditch. Also, an interesting find is a spore of hornwort (*Anthoceros*), in the upper sample (0.4m-0.41m), a plant of muddy ground.

Pollen sample depth (m)	0.4m- 0.41m	0.61m- 0.66m	0.76m- 0.77m	0.83m- 0.84m
<b>Trees + Shrubs</b>	32.7	27	29.3	
<b>Ericales</b>	2.0	4.3	6.0	
<b>Herbs</b>	61.3	63.1	55.7	
<b>Ferns</b>	4	4.3	9.0	
<b>Number of pollen grains in the pollen sum</b>	147	141	167	
<b>Trees and shrubs</b>				
<i>Alnus glutinosa</i> - alder	2.7	2.8	13.2	
<i>Betula</i> – birch	2	2.1	1.8	
<i>Corylus avellana</i> -type - hazel	1.4	5.7	9.6	1
<i>Fraxinus excelsior</i> - ash	0.9			
<i>cf Juniperus</i> - juniper	0.9			
<i>Pinus sylvestris</i> - pine	2.7	1.4	1.2	
<i>Prunus</i> - sloes/cherries	0.9			
<i>Quercus</i> - oak	21.8	14.2	3.6	
Rosaceae shrub pollen		2.8	1.2	
<i>Salix</i> - willow		0.7		
<b>Ericales</b>				
<i>Calluna vulgaris</i> - heather	2		5.4	
<i>Erica</i> - heaths			0.6	
<b>Possible crops</b>				
Cereal - type	4.1			
<b>Herbs</b>				
Apiacea - cow parsley family	0.9		1.2	
<i>Centaurea nigra</i> - common knapweed		0.7		
<i>Cirsium</i> - thistles		0.7		
<i>Taraxacum</i> -type - dandelion-type		0.7	1.8	1
Brassicaceae - mustard family	0.9			
Chenopodiaceae - goosefoot family	0.9	1.4	0.6	
Cyperaceae - sedges	2.7	0.7	0.6	
<i>Hypericum</i> - St John's wort	0.9			
<i>Plantago lanceolata</i> - ribwort plantain		1.4	3.0	
<i>Plantago major/media</i> - greater/hoary plantain			0.6	
<i>Plantago</i> sp - plantains undiff			2.4	
Poaceae - grasses	40.8	45.4	40.0	
<i>Potentilla</i> - cinquefoils			0.6	
<i>Ranunculus</i> - buttercup	5.4	1.4	0.6	
Scrophulariaceae figwort family		1.4		
<i>Succisa pratensis</i> - sheep's bit scabious			0.6	
<i>Rumex</i> -sorrels	1.4	3.5		
<i>Urtica</i> - nettles	2.0	0.7	1.8	
Unknown herbs	2.0	3.5	3.0	

<b>Aquatics</b>				
<i>Typha latifolia</i> - bulrush			0.6	
<b>Mosses, ferns and liverworts</b>				
<i>Sphagnum</i> – sphagnum moss	0.9		0.6	
<i>Osmunda regalis</i> - royal fern	0.9			
<i>Polypodium</i> – polypody	2.0	1.4	3.6	
<i>Pteridium aquilinum</i> - bracken		2.1	0.6	
Pteridopsida (monoete) – monoete ferns	1.4	2.1	4.8	
Anthoceros - hornwort	0.9			
Indeterminate grains	10.0	27.7	18.6	
Charcoal	41.6	58.2	++	

Table 2: Results of the pollen assessment of the fill, **505**, from the boundary ditch, **500**. The data are expressed as percentage values of the pollen sum, which includes all land pollen and spores. Charcoal is recorded as abundant (++), or a percentage of the pollen sum, plus charcoal fragments. The actual number of pollen grains recorded in sample 0.83m-0.84m are recorded in bold.

5.3.4 **Waterlogged plant remains:** Sample 2 contained very abundant waterlogged plant remains, which did include a little modern contamination. Wood, leaf and amorphous plant remains were abundant and insect remains were present. Large numbers of sloe (*Prunus spinosa*) stones, and elderberry (*Sambucus nigra*) and blackberry pips were recorded in the sample.

SAMP. NO	FLOT VOL. (ML)	FLOT DESCRIPTION	PLANT REMAINS	POTENTIAL
5	1000	Leaf fragments (4), buds (4), insect remains (1), feather (1)	WPR (4) <i>Prunus spinosa</i> (4)  <i>Rubus fruticosus</i> (2), <i>Sambucus nigra</i> (4), <i>Cirsium</i> (1)	Medium

Table 3: Assessment of waterlogged plant remains from Sample 2 from the fill, **505**, from the boundary ditch, **500** (plants are scored on a scale of 1-4, where 1 is rare (up to 5 items) and 4 is abundant (>100 items). WPR = Waterlogged plant remains)

## 5.4 INTERPRETATION AND DISCUSSION

5.4.1 The fill **505** of ditch **500**, on initial appearance, is like fresh leaf litter, but as it was sealed by topsoil **501** and residual bank clay **502** it is likely to be undisturbed. The excellent preservation of the plant remains is due to the wet anaerobic conditions. The abundant seeds of sloes, elderberry and blackberries suggest that they may have dropped from branches, possibly overhanging the ditch from the boundary hedgerow. Although there is little evidence in the pollen record for these shrubs except for some pollen from members of the rose family and a grain of sloe/cherry (*Prunus*) pollen.

- 5.4.2 The pollen evidence reflects the vegetation in the wider area, away from the ditch rather than that of the boundary hedgerow vegetation. It suggests that the surrounding area was largely open pasture or grassland initially, with possible arable cultivation later. This cultivation is evidenced by the presence of cereal-type pollen of the barley (*Hordeum*) group (Andersen 1979; Moore *et al* 1991, 100). Unfortunately, this group also includes some of the wild grasses, such as sweet grasses (*Glyceria*), and it is difficult to distinguish their pollen from that of barley. Sweet grasses are found growing in muddy conditions, by ditches or in shallow water, and may therefore have been growing next to, or in, the boundary ditch, **500**. Corroborative evidence for such wet muddy conditions (at the same depth as the cereal pollen) comes from the identification of a spore of hornwort, which is a liverwort-like taxon found growing on damp soils, probably around the edge of the ditch.
- 5.4.3 The historical boundary between the townships of Shavington-cum-Gresty and Basford in the ancient parish of Wybunbury was marked by a hedgerow, which was removed prior to the archaeological evaluation as part of the proposed development. The exact configuration of the boundary feature and date is unknown, and it was initially hoped that this could be recorded through the type of archaeological investigation that was carried out. In the Hunsterson township of Wybunbury parish, it was noted by Sylvester (1956 cited in Brennand 2006, 100) that two adjacent oval enclosures define the extent of the arable land thought to be medieval but undated. This makes the identification of the boundary embankment, seen in Trenches 5 and 6, and of ditch **500** extremely important, as would be the dating of any significant buried deposits from this boundary. Rural settlement and landuse in the early medieval and the medieval periods is poorly studied and understood in the North West, and was identified as an area for further initiatives in the Regional Research Agenda and Strategy (Brennand *et al* 2007, 79-84 and 97-101). The pollen analysis of fill **505** of ditch **500**, and the radiocarbon dating of suitable material from it will help towards our understanding of the development of the township boundary between Shavington and Basford.

## 5.5 SOIL MICROMORPHOLOGY

- 5.5.1 Three monolith samples (Samples 3 and 4 from Trench 5; and Sample 1 from Trench 6) from the historic boundary between the townships of Shavington-cum-Gresty and Basford in the ancient parish of Wybunbury were assessed for their soil micromorphological potential. Samples 3, 4 and 1 were briefly described and assessed (Goldberg and Macphail 2006; Hodgson 1997) in order to characterise the environmental condition of the landscape at the time of the boundary embankment construction, and the nature of the construction material.
- 5.5.2 **Results and discussion:** the three monolith samples are briefly described in Table 4. Local soils are Pelostagnogley soils (Crewe soil association) on reddish glaciolacustrine drift and till (OS 1983). This is consistent with the mottled gley silty-clay loam soils found in the bank samples and their 7.5YR and 10YR colours, and small amounts of included sand and weathered small stones. For example, in Trench 5, **503** is clearly a gleyed subsoil Bg horizon



material. It is possible that this layer was produced by the digging out of the ditch. The upper deposits of the boundary embankment in Trench 5 comprised:

- Lower **502**: a weakly humic deposit, of presumed ‘topsoil’ origin (either dumped or formed *in situ*),
- Upper **502**: a strongly-mottled subsoil Bg horizon material, containing anomalous charcoal flecks, which is clearly a dumped layer;
- Topsoil **501** is possibly an *in situ* weathered upper part of deposit **502**.

5.5.3 In Trench 6, however, the residual bank material clay deposits **601**, **602** and **603** are less strongly contrasting layers of mottled subsoils. These also appear to show a diminishing humic content downwards. This may be interpreted as that this bank was not formed by the dumping of contrasting soil materials, but instead the natural humus content reflects *in situ* post-depositional soil formation, implying a long history. Alternatively, the boundary bank in this location may have developed through colluviation (cf lynchet) or as a plough headland, achieving a rather uniform ‘bank’ that could then be influenced by post-medieval(?) *in situ* soil formation.

MONOLITH	THIN SECTION SAMPLE NO	BRIEF DESCRIPTION (DEPTH IN MONOLITH)
Trench 5; Monolith 3	1	<b>501</b> (0-13 cm): Brown (7.5YR4/2) moderately firm ZCL, with faint FeMn staining(?) and pink (7.5YR7/4) mottles; medium prisms; clear boundary.
Trench 5; Monolith 3	1	Upper <b>502</b> (13-30 cm): Brown (10YR4/4-7.5YR4/4) moderately firm ZCL with light grey (7.5YR7/0) and light brown (7.5YR6/4) mottles; moderately well developed medium prisms; small charcoal present; very few fine roots; clear boundary.
Trench 5; Monolith 3	2	Lower <b>502</b> (30-42 cm): Dark greyish brown to brown (10YR4/2-4/3) moderately firm ZCL with greater sand and small stone component compared to <b>502</b> ); poorly developed medium prisms and coarse subangular blocky; weakly humic(?); example of modern medium root and very few very fine roots; sharp boundary.
Trench 5; Monolith 3	3	<b>503</b> (42-52 cm): as below.
Trench 5; Monolith 4		<b>503</b> (28-55 cm): Brown (10YR4/3) moderately firm ZCL, with many coarse distinct brownish yellow (10YR6/8) and grey (10YR6/1) mottles; well-developed coarse prisms; example of modern medium root and very few very fine roots; stone-free apart from very few rotten/weathering rock fragments.
Trench 6;		<b>601</b> (0-17 cm): Very dark greyish brown (10YR3/2)

Monolith 1		moderately strong ZCL; weakly humic; moderately poorly formed medium prisms/subangular blocky; few very fine, fine and medium roots; clear boundary.
Trench 6; Monolith 1	4	<b>602</b> (17-37): Dark greyish brown (10YR4/2) moderately firm ZCL, with mainly faint yellowish brown (10YR5/6) mottles; very weakly humic(?); few medium roots; clear boundary.
Trench 6; Monolith 1	4	<b>603</b> (37-50 cm): Brown (10YR4/4-7.5YR4/4) moderately firm ZCL with light brown (7.5YR6/4) mottles; rare very fine roots; moderately well-developed coarse prisms.

Table 4: Brief description of the embankment soils (see Figs 7 and 9) and suggested thin-section sample location.



---

## 6. DISCUSSION

---

### 6.1 INTRODUCTION

- 6.1.1 The presence of known prehistoric finds spots close to the south-eastern and south-western parts of the development site may be indicative of activity from this period in the wider locality. Historic maps had shown that the proposed development site had long been used for agricultural purposes, and was likely to have seen little disturbance until the construction of the railway sidings in the late nineteenth century along the eastern side. Therefore, there was the potential for uncovering remains of relatively early activity. However, the evaluation did not produce any firm evidence for occupation of the site prior to at least the fifteenth century, from a piece of medieval pottery, with the majority of the artefactual evidence representing mainly post-medieval activity.
- 6.1.2 The general pattern of activity across the site and its immediate environs identified from the previous assessment (OA North 2002) can be divided into two broad phases (*c* 1500-1800 and *c* 1800-2008). The findings from the evaluation fit generally within these.

### 6.2 PHASE 1 (*c* 1500-1800)

- 6.2.1 Rural settlement and landuse in the early medieval and the medieval periods is poorly studied and understood in the North West, and was identified as an area for further initiatives in the Regional Research Agenda and Strategy (Brennand 2007). The township boundary between Shavington-cum-Gresty and Basford, of local historical significance, is believed to be ancient, and probably medieval, but its precise date of origin was unknown. The mapping evidence shows it within a landscape described by Rackham as ‘ancient’, as opposed to ‘planned’, with a land of hamlets, immense mileages of quiet minor roads, and thick hedges (Rackham 1986, 5), wherein the parish boundary would be hedged (Rackham 1994, 79). Although historic maps show the fields to be enclosed this appears to be less likely to do with the parliamentary enclosure widespread in the eighteenth and nineteenth century, but more of an informal piecemeal enclosure. The gradual hedging or fencing of land was a largely private process and can be identified from the more sinuous layout of boundaries. Those across the development area may not display typical reverse S-shaped boundaries often associated with ancient landscapes, but they do not display a regular pattern of boundaries dividing up the land typical of parliamentary enclosure (Barnes and Williamson 2006, 11-14).
- 6.2.2 No evidence for the date of construction of the township boundary bank and ditch was ascertained during the trenching. The results of micromorphological assessment suggested that the *in situ* post-depositional soil formation may imply a long period of use. When hedges were laid any associated ditch was usually scoured out, which helped to provide a secure barrier against livestock

but, more importantly on heavy land, they helped drain the adjacent fields and were connected via a complex maze of similar drains (as evident in the geophysical survey results (GSB 2003)) to natural watercourses. The soil dug out of the ditch was usually dumped on the adjacent hedge (Barnes and Williamson 2006, 4). If this was the case with the Shavington and Basford township boundary, the pollen content suggested that the surrounding land was mainly pasture when the ditch was being recut during the on-going maintenance. Any sign of arable activity in the area was not noted until late in the pollen sequence when the ditch was becoming infilled.

- 6.2.3 On-site evidence for medieval and post-medieval agricultural practices is represented by the scars of ridge and furrow, but no deposits of earlier periods survived. The single fragment of possible Midlands Purple type pottery is perhaps suggestive of some earlier activity. The condition of the sherd was not entirely worn or scarred, which suggested that it had not been moved far from its original deposition, in comparison with sherds commonly effected from ploughing activity. It is probable that the ploughsoil identified in Trench 1 may have accumulated during this time, but evidence would suggest that such agricultural activity was not in practice for any length of time.
- 6.2.4 In the Hunsterson township of this parish, it has been noted by Sylvester (1956 cited in Brennand *et al* 2006, 100) that two adjacent oval enclosures defined the extent of the arable land thought to be medieval but undated. Rural settlement and landuse in the early medieval and the medieval periods is poorly studied and understood in the North West (Brennand *et al* 2007, 79-84 and 97-101), and, therefore, identification of the boundary banks and ditch in Trenches 5 and 6, and any possibility of dating of the buried deposits from this boundary is significant.

### 6.3 PHASE 2 (1800-2008)

- 6.3.1 From the mid-nineteenth century the landscape was divided into formal field enclosures, as shown on the 1876 OS map. The map also shows the area surrounding the site was heavily industrialised, although the site itself remained largely undeveloped. No remains from this period were observed, although fragments of artefacts dating to this period are testament of continued farming activity into the late nineteenth century.
- 6.3.2 The possible fence line formed by the row of postholes observed in Trench 4 retained no dating evidence, although it is possible, given its proximity to a nearby farm, that it pertained to a temporary pen for livestock.

---

## 7. IMPACT AND RECOMMENDATIONS

---

### 7.1 IMPACT

- 7.1.1 The potential for surviving archaeological remains on the site has been assessed and identified in the study undertaken by OA North in 2002 (OA 2002) and the geophysical survey by GSB in 2003. This information, combined with the results of the evaluation, suggests that the site is considered to be of low or local archaeological significance.
- 7.1.2 Aside from ploughsoil in Trench 1, which had seemingly developed from as early as the eighteenth century, the archaeological deposits were mainly nineteenth century in date. A single piece of late medieval pottery from Trench 1 may tentatively suggest potential for the survival of earlier remains across the western area of the site.

### 7.2 RECOMMENDATIONS

- 7.2.1 In light of the presence of chert and late medieval pottery within the western side of the study area, the monitoring of earth-moving works via an archaeological watching brief may represent an appropriate mitigation strategy.
- 7.2.2 Initial investigation of the historic township boundary between Shavington-cum-Gresty and Basford was unable to provide a date for its construction. Nevertheless, the environmental assessment demonstrated a high potential for further analysis of both the boundary banks and ditch **500**, and for the dating of the ditch fill **505**. It is recommended, therefore, that further analysis of the pollen, and of the plant and insect remains from fill **505** should be undertaken. It is also recommended that suitable material should be selected from the ditch fill for two radiocarbon dates. In addition, the results of the soil micromorphological assessment suggested that in order to clarify the understanding of some of the suggested site formation models, four thin sections should be employed to investigate the bank deposits and the boundaries between them (three from Trench 5 and one from Trench 6; Table 1).

---

## 8. BIBLIOGRAPHY

---

### 8.1 CARTOGRAPHIC SOURCES

Burdett's Map of Cheshire 1777

CRO/EDT 41/2 Tithe Commutation Map, c 1839 – Township of Shavington

Ordnance Survey First Edition 6": 1 mile map, 1876

Ordnance Survey Soil Survey of England and Wales (1983)

### 8.2 SECONDARY SOURCES

Adams, M, 2000 *An Archaeological Desk-Based Assessment of the Proposed A500 Basford-Hough-Shavington Bypass*, Liverpool Museum Field Archaeology Unit, unpubl rep

Andersen, S Th, (1979) Identification of wild grasses and cereal pollen, *Danm Geol Unders*, **1978**, 69-92

Barnes, G and Williamson, T, 2006 *Hedgerow History; Ecology, History and Landscape Character*, Oxford

Berglund, BE, and Ralska-Jasiewiczowa, M, 1986 Pollen analysis and pollen diagrams, in Berglund, BE (ed) *Handbook of Holocene Palaeoecology and Palaeohydrology*, Chichester, pp 455-484.

Brennand, M, Chitty, G, and Nevell, M, (eds), 2006 *The Archaeology of North West England. An Archaeological Research Framework for North West England: Volume 1. Resource Assessment*, Archaeology North West Volume, 8

Brennand, M, Chitty, G, and Nevell, M, (eds), 2007 *Research and Archaeology in North West England. An Archaeological Research Framework for North West England: Volume 2 Research Agenda and Strategy*, Archaeology North West Volume 9

Brooks, D, and Thomas, K W, 1967 The distribution of pollen grains on microscope slides. The non randomness of the distribution, *Pollen et Spores*, **9**, 621-629.

Cheshire County Council Environmental Planning (CCC), 2003 *Guidance and General Conditions for Archaeological Contractors and Consultants in Cheshire*, unpubl

Countryside Commission, 1998 *Countryside Character, Volume 2: North West*, Cheltenham



- Department of the Environment (DoE), 1990 *Planning Policy Guidance Note 16: archaeology and the environment (PPG16)*, London
- English Heritage, 1991 *Management of Archaeological Projects*, 2nd edn, Swindon
- English Heritage, 2001 *Guidelines for Environmental Archaeology*, 2nd edn, Swindon
- Faegri, K, and Iversen, J, 1989 *Textbook of Pollen Analysis*, 4<sup>th</sup> Ed, Chichester
- Fussell, GE, 1955 Four Centuries of Cheshire Farming Systems, *Hist Soc Cheshire*, **106**
- Gelling, M, 1992 *West Midlands in the Early Middle Ages*, Leicester
- Geophysical Surveys of Bradford (GSB), 2003 *Basford West: Geophysical Survey (2002/92)*, unpubl rep
- Goldberg, P, and Macphail, RI, 2006 *Practical and Theoretical Geoarchaeology*, Oxford
- Haworth, D, and Comber, WM, 1952 *Cheshire Village Memories*, Malpas
- Higham, NJ, 1993 *The Origins of Cheshire*, Manchester
- Hodgson, JM, 1997 *Soil Survey Field Handbook, Technical Monograph No. 5* Soil Survey and Land Research Centre, Silsoe.
- Institute of Field Archaeologists, 1994 *Code of conduct* (revised edition), unpubl
- Institute of Field Archaeologists, 1999 *Standard and guidance for archaeological field evaluations*, unpubl
- Longley, DMT, 1987 Prehistory, in CR Elrington (ed), *The Victoria History of the Counties of England: Cheshire*, **1**, Oxford
- Leah, M, Wells, CE, Appleby, C, and Huckerby, E, 1997 *The Wetlands of Cheshire*, Lancaster Imprints, **5**, Lancaster
- Margary, ID, 1957 *Roman Roads in Britain*, **2**, London
- Moore, PD, Webb, JA, and Collinson, ME, 1991 *Pollen Analysis* 2<sup>nd</sup> Ed, Oxford
- Morgan, P, 1978 Cheshire, in *Domesday Book*, J Morris (ed), **26**, Chichester
- Morris, E, 1985 Prehistoric Salt Distribution: Two Case Studies from Western Britain, *Bull Board Celtic Stud*, **32**
- Nevell, M, 1991 *Tameside 1066-1700: A History and Archaeology of Tameside*, Manchester

- Nulty, G, 1959 *Shavington: The Story of a South Cheshire Village*, Nantwich
- O'Dwyer, S, 1935 *The Roman Roads of Cheshire: An Historical Survey*, Newtown
- OAU, 2005 *Environmental Guidelines and Manual*, unpubl
- OA North, 2002 *Basford West, Crewe, Cheshire; Archaeological Assessment*, unpubl report
- OA North, 2008a *Chorlton Fold, Eccles, Greater Manchester; Post Excavation Assessment*, unpubl rep
- OA North, 2008b *Surface Mining and Reclamation Facility, Cutacre, Salford, Greater Manchester: Post-excavation Assessment*, unpubl rep
- Peglar, SM, 1993 The mid-Holocene *Ulmus* decline at Diss Mere, Norfolk, UK: a year-by-year pollen stratigraphy from annual laminations, *The Holocene*, **3** (1), 1-13
- Penney, S, and Shotter, DCA, 1996 An Inscribed Roman Salt Pan from Shavington, Cheshire, *Britannia*, **27**
- Phillips, CB, and Smith, JH, 1994 *Lancashire and Cheshire from AD 1540*, London
- Price, J, 1994 The Discovery of an Early Saltworking Site Near Crewe, *Cheshire Past*, **3**
- Rackham, O, 1986 *The History of the Countryside*, London
- Rackham, O, 1994 *The Illustrated History of the Countryside*, London
- Scholes, R, 2000 *Towns and Villages of Britain: Cheshire*, Wilmslow
- Stace, C, 1997, *New Flora of the British Isles*, Cambridge
- Stead, IM, Bourke, JB, and Brothwell, D (eds), 1986 *Lindow Man the Body in the Bog*, London
- Stockmarr, J, 1972, Tablets with spores used in absolute pollen analysis, *Pollen et Spores*, **13**, 615-621.
- Sylvester, D, 1971 *A History of Cheshire*, Henley-on-Thames
- Sylvester, D, and Nulty, G, 1958 *The Historical Atlas of Cheshire*, Chester
- Thacker, AT, 1987 Anglo-Saxon Cheshire, in CR Elrington (ed), *The Victoria History of the Counties of England: Cheshire*, **1**, Oxford
- Turner, RC, and Scaife, RG (eds), 1995 *Bog Bodies; New Discoveries and New Perspectives*, London

Watkin, WT, 1886 *Roman Cheshire*, Liverpool

Webster, G, 1975 *The Cornovii*, London

---

## APPENDIX 1: PROJECT DESIGN

---

### 1. INTRODUCTION

#### 1.1 PROJECT BACKGROUND

1.1.1 Goodman Ltd (hereafter the 'client'), acting on behalf of Taylor Woodrow Property Co Ltd, requested that Oxford Archaeology North (OA North) submit proposals for an archaeological evaluation at land off Crewe Road, Basford West, Crewe, Cheshire (centred NGR SJ 710530), which is proposed for redevelopment as warehousing and distribution, manufacturing and light industrial/office use and associated ancillary works (planning application reference P03/1071). The local planning authority, Crewe and Nantwich Borough Council, has granted planning permission with a number of conditions; condition 24 has requested a programme of archaeological evaluation based on the results of the geophysical survey undertaken predetermination (GSB 2003), following an archaeological assessment carried out in 2002 (OA North 2002), and an investigation of the parish boundary. It is possible that important archaeological remains will be affected by the proposed development. The following project design has been prepared in accordance with a verbal brief, subsequent to a letter dated 4 December 2003, issued by Mark Leah Cheshire County Council's (CCC) Archaeological Officer (Development Control) (AO).

#### 1.2 OXFORD ARCHAEOLOGY NORTH

1.2.1 OA North has undertaken a great number of small and large scale projects throughout Northern England during the past 30 years. Evaluations, assessments, watching briefs and excavations have taken place within the planning process, to fulfil the requirements of clients and planning authorities, to very rigorous timetables. OA North has been involved with the Basford East project since 2002, when an archaeological assessment and subsequent geophysical survey, in 2003, were carried out during the planning application process.

1.2.2 OA North has the professional expertise and resources to undertake the project detailed below to a high level of quality and efficiency. OA North is an Institute of Field Archaeologists (IFA) **registered organisation, registration number 17**, and all its members of staff operate subject to the IFA Code of Conduct (1994).

### 2. OBJECTIVES

2.1 The assessment aims to evaluate archaeological deposits that may be threatened by the proposed development in order to determine their presence, extent, nature and significance. To this end, the following evaluation programme has been designed. The results will provide the local planning authority with the necessary information to determine the requirement for either further mitigation works prior to, or during, the development, or whether the remains should be preserved *in situ*, in accordance with PPG16 (DoE 1990). The required stages to achieve these ends are as follows:

2.2 **Archaeological Evaluation:** to implement a programme of trial trenching examining a minimum of 6 trenches within the outlined development area (in accordance with the Cheshire County Council guidelines (2003) Standards and IFA standards (1994, 1999b)). These will focus on two elements;

- a) the four areas of detailed geophysical survey, Areas A, B, C and E, containing anomalies of possible archaeological potential (GSB 2003) to be targeted each with a 20m long evaluation trench. This will aim to ground truth the anomalies and, therein, help to refine the effectiveness of such surveys as an evaluation tool. Any significant deposits will require further archaeological work, which will be dealt with in a separate project design.



- b) the historical township boundary between Basford and Shavington-cum-Gresty, in the ancient parish of Wybunbury, will be examined through two trenches, the length of which will be determined by the feature (including bank and ditch). The investigation will aim to record any buried soil horizons, and assess and date any significant deposits. Further analysis of any significant deposits may be found to be necessary in mitigation of the development, which will be under a separate project design.
- 2.3 **Report and Archive:** a report will be produced for the client within eight weeks, unless a report submission deadline is agreed with the client at the time of commission. An archive will be produced to English Heritage guidelines (MAP 2 (1991)).
- 3 METHOD STATEMENT
- 3.1 INTRODUCTION
- 3.1.1 The following work programme is submitted in line with the objectives summarised above.
- 3.2 TRIAL TRENCHING OF GEOPHYSICAL ANOMALIES (TRENCHES 1-4)
- 3.2.1 The programme of trial trenching will target geophysical survey anomalies to assess the effectiveness of the survey technique as an evaluation tool, as well as establishing the presence or absence of any previously unsuspected archaeological deposits. In this way, it will provide information concerning the threatened available area to be used to inform any necessary mitigation strategy.
- 3.2.2 **Trench configuration:** the evaluation is required to examine four 20m long trial trenches, measuring *c* 2m in width (the approximate width of a typical excavator bucket). These will be located in four of the areas, Areas A, B, C, and E, surveyed using magnetometry in 2003 containing anomalies of archaeological potential (GSB 2003).
- 3.2.3 **Methodology of excavation:** Trenches 1-4 will be excavated by first removing the topsoil and modern overburden by machine (fitted with a toothless ditching bucket) under archaeological supervision to the surface of the first significant archaeological deposit or natural deposits. All trenches will be excavated in a stratigraphical manner, whether by machine or by hand. The first archaeological surface or natural geology will be cleaned by hand, using either hoes, shovel scraping, and/or trowels depending on the subsoil conditions, and inspected for archaeological features. All features of archaeological interest will be investigated and recorded unless otherwise agreed by the CCC Planning Archaeologist.
- 3.2.4 **Environmental Assessment:** environmental samples (bulk samples of 40 litres volume, to be sub-sampled at a later stage) will be collected from stratified undisturbed deposits and will particularly target negative features (gullies, pits and ditches). An assessment of the environmental potential of the site will be undertaken through the examination of suitable deposits by the in-house palaeoecological specialist (see 3.4 below), who will examine the potential for further analysis. The assessment would include soil pollen analysis and the retrieval of charred plant macrofossils and land molluscs from former dry-land palaeosols and cut features. In addition, the samples would be assessed for plant macrofossils, insect, molluscs and pollen from waterlogged deposits. The costs for the palaeoecological assessment are defined as a contingency and will only be called into effect if good deposits are identified and will be subject to the agreement of the CCC Planning Archaeologist and the client.
- 3.2.5 Advice will also be sought as to whether a soil micromorphological study or any other analytical techniques will enhance the understanding of the site formation processes, including the amount of truncation to buried deposits and the preservation of deposits within negative features. Should this be required the costs for analysis have been provided as a contingency.

### 3.3 EXAMINATION OF THE HISTORICAL TOWNSHIP BOUNDARY (TRENCHES 5-6)

- 3.3.1 The historical boundary between the townships of Shavington-cum-Gresty and Basford in the ancient parish of Wybunbury is marked presently by a hedgerow, which will be removed as part of the proposed development. The exact configuration of the feature and date is unknown and will, therefore, be recorded through archaeological investigation.
- 3.3.2 In the Hunsterson township of this parish it has been noted by Sylvester (1956 cited in Brennand 2006, 100) that two adjacent oval enclosures define the extent of the arable land thought to be medieval but undated. This makes the dating of any significant buried deposits from this boundary extremely important. Rural settlement and landuse in the early medieval and the medieval periods is poorly studied and understood in the North West and was identified as an area for further initiatives in the Regional Research Agenda and Strategy (Brennand, 2007, 79-84 and 97-101).
- 3.3.3 **Trench configuration:** two trenches/slots will be excavated through the boundary feature, the dimensions of which will be dictated by the width of the boundary feature.
- 3.3.4 **Methodology of excavation:** Trenches 5 and 6 will comprise slot trenches excavated through the boundary feature straight down to the underlying natural deposits. This will provide a profile through the boundary, which will be cleaned by hand using trowels and inspected for buried soil horizons, as well as the relationship between the embankment and any associated ditch.
- 3.3.5 **Environmental Assessment:** should a bank or ditch be identified, a programme of environmental assessment and dating of any buried soils or ditch deposits will be undertaken and, if required, recommendations for further work (analysis) will be made. Any such analysis will be in consultation with the CCC AO and will be dealt with separately. During the assessment, OA North will consult with the English Heritage regional scientific advisor, Dr Sue Stallibrass and will follow the English Heritage Guidelines for Environmental Archaeology (English Heritage 2002).
- 3.3.6 A member of OA North environmental archaeology team will visit the site during the excavation and assist the field work team in planning an environmental sampling strategy for the excavation of the boundary. A soil micromorphologist may be required to visit the site should a buried soil be identified, which has been included as a contingency cost and will be implemented in consultation with the client and CCC AO.
- 3.3.7 If a bank or ditch is identified, bulk samples (30 litre) will be taken from all secure contexts in sealed plastic buckets for the assessment of charred and waterlogged plant remains and other possible biological indicators. The ditch fills will be sampled for pollen with monolith tins, sealed and transport to OA North's offices where they will be assessed as to their potential for pollen analysis. The buried soils will be sampled with kubiena tins or other suitable containers, sealed and transport to OA North's offices and submitted to the relevant specialist who will assess their potential for soil micromorphology and pollen analysis. All samples will be clearly labelled and an environmental sample register will be kept.

### 3.4 GENERAL PROCEDURES

- 3.4.1 Trenches will be located by use of GPS equipment, which is accurate to +/- 0.25m, or Total Station. Altitude information will be established with respect to Ordnance Survey Datum.
- 3.4.2 The trenches will not be excavated deeper than 1.2m to accommodate health and safety constraints, without shoring or stepping out of the trench sides. Should this be required, this may be costed as a variation.
- 3.4.3 Any investigation of intact archaeological deposits will be exclusively manual. Selected pits and postholes will normally only be half-sectioned, linear features will be subject to no more than a 10% sample, and extensive layers will, where possible, be sampled by partial rather than complete removal. It is hoped that in terms of the vertical stratigraphy, maximum

information retrieval will be achieved through the examination of sections of cut features. All excavation, whether by machine or by hand, will be undertaken with a view to avoiding damage to any archaeological features, which appear worthy of preservation *in situ*.

- 3.4.4 All information identified in the course of the site works will be recorded stratigraphically, using a system, adapted from that used by Centre for Archaeology Service of English Heritage, with sufficient pictorial record (plans, sections, monochrome contacts, and digital photographs for presentation purposes) to identify and illustrate individual features. Primary records will be available for inspection at all times.
- 3.4.5 Results of all field investigations will be recorded on *pro forma* context sheets. The site archive will include both a photographic record and accurate large scale plans and sections at an appropriate scale (1:50, 1:20 and 1:10). All artefacts and ecofacts will be recorded using the same system, and will be handled and stored according to standard practice (following current Institute of Field Archaeologists guidelines and the Cheshire County Council guidelines (2003)) in order to minimise deterioration.
- 3.4.6 ***Palaeoenvironmental Assessment Laboratory Methods:*** the costs for the following assessments of the samples have been included as contingency items due to the unknown presence and quantity.
- 3.4.7 ***Charred and Waterlogged plant remains:*** the bulk samples will be processed by manual flotation, the flots will be collected on a 250 micron mesh and air dried air. All plant material will be rapidly assessed under a microscope, provisionally identified and recorded on a scale of 1-5, where 1 is less than 5 items and 5 is more than 100 items. Plant nomenclature will follow Stace (1997).
- 3.4.8 ***Pollen:*** the samples for the pollen assessment will be prepared in the laboratory of the Geography Department at the University of Lancaster. Subsamples of a standard size (1ml in volume) will be prepared for pollen analysis using the standard technique of heating with hydrochloric acid, sodium or potassium hydroxide, sieving, hot hydrofluoric acid, and Erdtman's acetolysis to remove carbonates, humic acids, large particles, silicates, and cellulose, respectively. The samples will then be stained with safranin, dehydrated with tertiary butyl alcohol and mounted in 2000 centistoke silicone oil (Method B of Berglund and Ralska-Jasiewiczowa (1986). Tablets containing a known number of *Lycopodium* spores will be added to the known volume of sediment at the beginning of the preparation so that pollen and spore concentrations can be calculated (Stockmarr 1972). Pollen will counted from ten equally spaced traverses or to a sum of 100 grains across two slides at a magnification of x400 (x1000 for critical examinations). Identifications will be aided by keys (Moore *et al* 1991; Faegri *et al* 1989) and a small modern reference collection. Cereal-type grains will be defined using the criteria of Andersen (1979). Indeterminate grains will be recorded using groups based on those of Birks (1973) as an indication of the state of pollen preservation. Charcoal particles >5 microns will also be recorded following the procedures of Peglar (1993). Other identifiable inclusions on the pollen slides (fungal spores, turbellarian eggs, pre-Quaternary spores, etc.) will also be registered. Plant nomenclature follows Stace (1997).
- 3.4.9 ***Soil Micromorphology:*** the soil samples will be submitted to the relevant specialist to assess their potential for analysis.
- 3.4.10 ***Dating:*** material suitable for radiocarbon dates will be selected in the laboratory by the OA North environmental staff. The samples will be submitted to Dr Gordon Cook at the Scottish Universities Environmental research Centre at East Kilbride for AMS dating. The cost of this has been provided as a contingency item.
- 3.4.11 The OA North environmental team will produce a detailed written report, which will include a specialist report, to be included in the final evaluation report together with a non technical summary of the results. Care will be taken to ensure that colloquial plant names, where possible, are used alongside the scientific ones. Radiocarbon dates will be calibrated using

the calibration OxCal programme and copies of the laboratory certificates will be included in the report.

- 3.4.12 **Faunal remains:** if there is found to be the potential for discovery of bones of fish and small mammals a sieving programme will be carried out. These will be assessed as appropriate by OA North's specialist in faunal remains, and subject to the results, there may be a requirement for more detailed analysis. A contingency has been included for the assessment of such faunal remains for analysis.
- 3.4.13 **Human Remains:** any human remains uncovered will be left *in situ*, covered and protected. No further investigation will continue beyond that required to establish the date and character of the burial. CCC and the local Coroner will be informed immediately. If removal is essential the exhumation of any funerary remains will require the provision of a Home Office license, under section 25 of the Burial Act of 1857. An application will be made by OA North for the study area on discovery of any such remains and the removal will be carried out with due care and sensitivity under the environmental health regulations. Any delays caused by unforeseen and complex excavation of inhumations may be subject to a variation to the cost of the contract and will be agreed with the client.
- 3.4.14 **Treatment of finds:** all finds will be exposed, lifted, cleaned, conserved, marked, bagged and boxed in accordance with the United Kingdom Institute for Conservation (UKIC) *First Aid For Finds*, 1998 (new edition) and the recipient museum's guidelines.
- 3.4.15 **Treasure:** any gold and silver artefacts recovered during the course of the excavation will be removed to a safe place and reported to the local Coroner according to the procedures relating to the Treasure Act, 1996. Where removal cannot take place on the same working day as discovery, suitable security will be employed to protect the finds from theft.
- 3.4.16 All identified finds and artefacts will be retained, although certain classes of building material can sometimes be discarded after recording if an appropriate sample is retained on advice from the recipient museum's archive curator.
- 3.4.17 **Contingency plan:** a contingency costing may also be employed for unseen delays caused by prolonged periods of bad weather, vandalism, discovery of unforeseen complex deposits and/or artefacts which require specialist removal, use of shoring to excavate important features close to the excavation sections etc. This has been included in the Costings document and would be in agreement with the client.
- 3.4.18 The evaluation will provide a predictive model of surviving archaeological remains detailing zones of relative importance against known development proposals. In this way, an impact assessment will also be provided.

### 3.5 REPORT AND ARCHIVE

- 3.5.1 One bound and one unbound copy of a written synthetic report will be submitted to the client, and a copy each to the Cheshire HER and Planning Archaeologist within eight weeks of completion of the completion of the survey fieldwork, unless an alternative deadline is agreed with the client beforehand. It will present, summarise, and interpret the results of the programme detailed above in order to come to as full an understanding as possible of the archaeology of the development area. The report will be prepared in accordance with the Cheshire County Council guidelines (2003) and will include;
- a site location plan related to the national grid
  - a front cover to include the planning application number and the NGR
  - a concise, non-technical summary of the results
  - the circumstances of the project and the dates on which the fieldwork was undertaken



- description of the methodology, including the sources consulted
- a summary of the historical background of the study area
- an interpretation of the results and their significance, using the ‘Secretary of State’s criteria for scheduling ancient monuments’ included as Annex 4 of PPG 16 (DoE 1990)
- appropriate plans showing the location and position of features or sites located
- a statement, where appropriate, of the archaeological implications of the proposed development
- monochrome and colour photographs as appropriate
- a copy of this project design, and indications of any agreed departure from that design
- the report will also include a complete bibliography of sources from which data has been derived, and a list of any further sources identified but not consulted
- plans and sections showing the positions of deposits and finds
- an index to the project archive

3.5.2 **Confidentiality:** all internal reports to the client are designed as documents for the specific use of the client, for the particular purpose as defined in the project brief and project design, and should be treated as such. They are not suitable for publication as academic documents or otherwise without amendment or revision.

### 3.6 ARCHIVE

3.6.1 The results of all archaeological work carried out will form the basis for a full archive to professional standards, in accordance with Appendix 3 of the current English Heritage guidelines (*Management of Archaeological Projects*, 2nd edition, 1991) and UKIC (1990). This archive will be provided in the English Heritage Centre for Archaeology format and a synthesis will be submitted to the HER (the index to the archive and a copy of the report). OA North practice is to deposit the original record archive of projects (paper, magnetic and plastic media) with the County Record Office.

## 4. HEALTH AND SAFETY

4.1 **Risk Assessment:** OA North provides a Health and Safety Statement for all projects and maintains a Unit Safety policy. All site procedures are in accordance with the guidance set out in the Health and Safety Manual compiled by the Standing Conference of Archaeological Unit Managers (1997). A written risk assessment will be undertaken in advance of project commencement and copies will be made available on request to all interested parties.

4.2 **Services and other constraints:** full regard will, of course, be given to all constraints (services etc.) during the evaluation as well as to all Health and Safety considerations. As a matter of course the field team will use a Cable Avoidance Tool (CAT) prior to any excavation to test for services. However, this is only an approximate location tool. Any **information regarding services**, i.e. drawings or knowledge of live cables or services, within the study area and held with the client should be made known to the OA North project manager prior to the commencement of the evaluation.

4.3 **Contamination:** any known contamination issues or any specific health and safety requirements on site should be made known to OA North by the client to ensure all procedures can be met, and that the risk is dealt with appropriately. Should any presently unknown contamination be discovered during excavation, it may be necessary to halt the

works and reassess the risk assessment. Should it be necessary to supply additional PPE or other contamination avoidance equipment this will be costed as a variation.

4.4 **Staff issues:** all project staff will be CSCS qualified, proof of which can be provided in the form of CSCS cards.

4.5 A portable toilet with hand washing facilities is required and can be provided and located on or adjacent to the site, unless the client would prefer to arrange alternative facilities. Therefore, the cost has been provided as a contingency item.

4.6 **Fencing requirements:** the excavation trench and any areas of archaeological sensitivity will be protected with barrier tape whilst open, and any appropriate signage. The trenches will be opened and backfilled within the same day for purposes of site security, once archaeological recording has been completed. Any other requirements for fencing at the client's request (e.g. Heras-type security fencing) may be charged as a variation.

## 5 OTHER MATTERS

### 5.1 ACCESS

5.1.1 Liaison for basic site access will be undertaken through the client and it is assumed that there is access for both pedestrian and plant traffic to the site.

5.1.2 The excavation of Trenches 5 and 6 will be undertaken following consultation with the client to ensure that all ecological requirements/constraints have been fulfilled or OA North are made aware prior to commencement.

### 5.2 REINSTATEMENT

5.2.1 It is understood that there will be no requirement for reinstatement of the ground beyond backfilling. The ground will be backfilled so that the topsoil is laid on the top, and the ground will be roughly graded with the machine.

### 5.3 PROJECT MONITORING

5.3.1 Whilst the work is undertaken for the client, the Planning Archaeologist, Mark Leah, will be kept fully informed of the work and its results and will be notified a week in advance of the commencement of the fieldwork. Any proposed changes to the project design will be agreed with Mark Leah in consultation with the client.

### 5.4 INSURANCE

5.4.1 OA North has a professional indemnity cover to a value of £2,000,000; proof of which can be supplied as required.

### 5.5 WORK TIMETABLE

5.5.1 **Archaeological Trenching:** it is anticipated that this element would require up to four days for a team of three people, plus a day for an OA North palaeoenvironmentalist.

5.5.2 **Report:** the final report will be submitted to the client within eight weeks, unless an earlier deadline is agreed at the time of commission.

5.5.3 **Archive:** the archive will be deposited within six months.

### 5.6 STAFFING

5.6.1 The project will be under the direct management of **Emily Mercer BA (Hons) MSc AIFA** (OA North Senior Project Manager) to whom all correspondence should be addressed.

- 5.6.2 The evaluation will be supervised by an OA North project officer or experienced in this type of project. Due to scheduling requirements it is not possible to provide these details at the present time. All OA North project officers are experienced field archaeologists capable of carrying out projects of all sizes.
- 5.6.3 Assessment of the finds from the evaluation will be undertaken under the auspices of OA North's in-house finds specialist **Christine Howard-Davis** (OA North finds manager). Christine has extensive knowledge of finds from many periods.
- 5.6.4 Assessment of any palaeoenvironmental samples will be undertaken by or under the auspices of **Elizabeth Huckerby MSc** (OA North project officer). Elizabeth has extensive knowledge of the palaeoecology of the North West through her work on the English Heritage-funded North West Wetlands Survey. An assessment of the soil micromorphology, should it be necessary, will be undertaken by **Dr Richard MacPhail, University College, London**.

## REFERENCES

- Andersen, S TH, 1979 Identification of wild grasses and cereal pollen, *Danm geol Unders*, **1978**, 69-92
- Berglund, BE and Ralska-Jasiewiczowa, M, 1986 Pollen analysis and pollen diagrams. In: B.E. Berglund (ed.) *Handbook of Holocene Palaeoecology and Palaeohydrology*, Chichester, 455-484
- Birks, HJB, 1973, *Past and Present Vegetation of the Isle of Skye: a Palaeoecological Study*, London
- Brennand, M, Chitty, G, and Nevell, M, (eds), 2006 *The Archaeology of North West England. An Archaeological Research Framework for North West England: Volume 1. Resource Assessment* Archaeology North West Volume 8
- Brennand, M, Chitty, G, and Nevell, M, (eds), 2007 *Research and Archaeology in North West England. An archaeological Research Framework for North West England: Volume 2 Research Agenda and Strategy* Archaeology North West Volume 9
- Cheshire County Council Environmental Planning (CCC), 2003 *Guidance and General Conditions for Archaeological Contractors and Consultants in Cheshire*, unpubl
- Department of the Environment (DoE), 1990 *Planning Policy Guidance Note 16: archaeology and the environment (PPG16)*, London
- English Heritage, 1991 *Management of Archaeological Projects*, 2nd edn, London
- English Heritage, 2001 *Environmental Archaeology: a guide to the theory and practice of environmental methods from sampling and recovery to post-excavation*, London
- Fægri, K, and Iversen, J, 1989 *Textbook of modern pollen analysis*, 4<sup>th</sup> ed, Chichester
- Geophysical Surveys of Bradford (GSB), 2003 *Basford West: Geophysical Survey (2002/92)*, unpubl
- Institute of Field Archaeologists, 1994 *Code of conduct* (revised edition), unpubl
- Institute of Field Archaeologists, 1999b *Standard and guidance for archaeological field Evaluations*, unpubl
- Moore, PD, Webb, JA, and Collinson, ME, 1991 *Pollen Analysis*, 2<sup>nd</sup> ed, Oxford
- OA North, 2002 *Basford West, Crewe: Archaeological Desk-Based Assessment Report*, unpubl
- Peglar, SM, 1993 The mid-Holocene *Ulmus* decline at Diss Mere, Norfolk, UK: a year-by-year pollen stratigraphy from annual laminations, *The Holocene*, **3**,

SCAUM (Standing Conference of Archaeological Unit Managers), 1997 *Health and Safety Manual*, Poole

Stace, C, 1997, *New Flora of the British Isles*, Cambridge

Stockmarr, J, 1972 Tablets with spores used in absolute pollen analysis. *Pollen et Spores*, **13**, 615-621

UKIC, 1990 *Guidelines for the Preparation of Archives for Long-Term Storage*, London

UKIC, 1998 *First Aid for Finds*, London



## APPENDIX 2: CONTEXT LIST

<b>Context</b>	<b>Trench</b>	<b>Description</b>	<b>Phase</b>
<b>100</b>	1	Topsoil	2
<b>101</b>	1	Subsoil	1
<b>102</b>	1	Yellow clay representing a natural geological horizon	-
<b>200</b>	2	Yellow clay representing a natural geological horizon	-
<b>201</b>	2	Orange clay	-
<b>202</b>	2	Subsoil	1
<b>203</b>	2	Topsoil	2
<b>204</b>	2	Animal burrow	-
<b>205</b>	2	Field drain	2
<b>300</b>	3	Topsoil	2
<b>301</b>	3	Light brown clay representing a natural geological horizon	-
<b>400</b>	4	Topsoil	2
<b>401</b>	4	Natural geological horizon	-
<b>402</b>	4	Posthole	1/2
<b>403</b>	4	Fill of <b>402</b>	1/2
<b>404</b>	4	Posthole	1/2
<b>405</b>	4	Fill of <b>404</b>	1/2
<b>406</b>	4	Posthole	1/2
<b>407</b>	4	Fill of <b>406</b>	1/2
<b>500</b>	5	Boundary ditch	1
<b>501</b>	5	Topsoil	2
<b>502</b>	5	Light brown clay (residual bank material)	1
<b>503</b>	5	Orange-brown clay (residual bank material)	1
<b>504</b>	5	Grey-brown clay representing a natural geological horizon	-
<b>505</b>	5	Fill of ditch <b>500</b>	1
<b>600</b>	6	Topsoil	2
<b>601</b>	6	Light brown clay (residual bank material)	1
<b>602</b>	6	Mid brown clay (residual bank material)	1
<b>603</b>	6	Yellow clay (residual bank material)	1
<b>604</b>	6	Natural geological horizon	-
<b>605</b>	6	Ditch	1
<b>606</b>	6	Fill of ditch <b>605</b>	1

## APPENDIX 3: FINDS CATALOGUE

Object no	Context	Trench	Count	Material	Description	Period
1005	<b>100</b>	1	3	Pottery	Overfired Midland Purple type glazed jug in a hard-fired partially reduced fabric. Mottled ware bowl. Thin walled heavy lead glazed Blackware in sandy red fabric	15th-18th century
1004	<b>101</b>	1	1	Flint	Unworked poor quality lump resembling a core. The chipped appearance is a result of frost shatter or from the effects of ploughing	Not datable
1003	<b>100</b>	1	2	Clay Tobacco Pipe	Medium bore undecorated stems	19th century
1002	<b>203</b>	2	1	Pottery	Hand-painted gold over blue transfer glazed white earthenware sugar bowl	19th century
1001	<b>203</b>	2	1	Glass	Small melted lump	Not datable
1000	<b>300</b>	3	1	Pottery	Willow patterned transfer-printed white earthenware plate	19th century

---

## ILLUSTRATIONS

---

### LIST OF FIGURES

Figure 1: Site location

Figure 2: Location of evaluation trenches in relation to geophysical survey results

Figure 3: Detailed plan of Trench 1

Figure 4: Detailed plan of Trench 2

Figure 5: Detailed plan of Trench 4

Figure 6: Detailed plan of Trench 5

Figure 7: North-facing section through Trench 5

Figure 8: Detailed plan of Trench 6

Figure 9: North-facing section through Trench 6

### LIST OF PLATES

Plate 1: Burdett's Map of Cheshire, 1777

Plate 2: Tithe Commutation Map, c 1839 – Township of Shavington

Plate 3: Ordnance Survey 1876, 1st Edition 6":1mile

Plate 4: View of Trench 1, looking north

Plate 5: East-facing section through Trench 1, showing remnants of possible ploughsoil **100**

Plate 6: View of Trench 2, looking east

Plate 7: View of the extant pond, formerly identified as a hollow, looking east

Plate 8: View of Trench 3, looking west

Plate 9: View of Trench 4, looking north-east

Plate 10: North-facing section through Trench 5, positioned on the township boundary between Shavington-cum-Gresty and Basford

Plate 11: North-facing section through part of the bank in Trench 5, looking south along the line of the boundary

Plate 12: View of Trench 6, looking west

Plate 13: South-facing section through the township boundary showing the disturbed ditch **605**, looking north-east



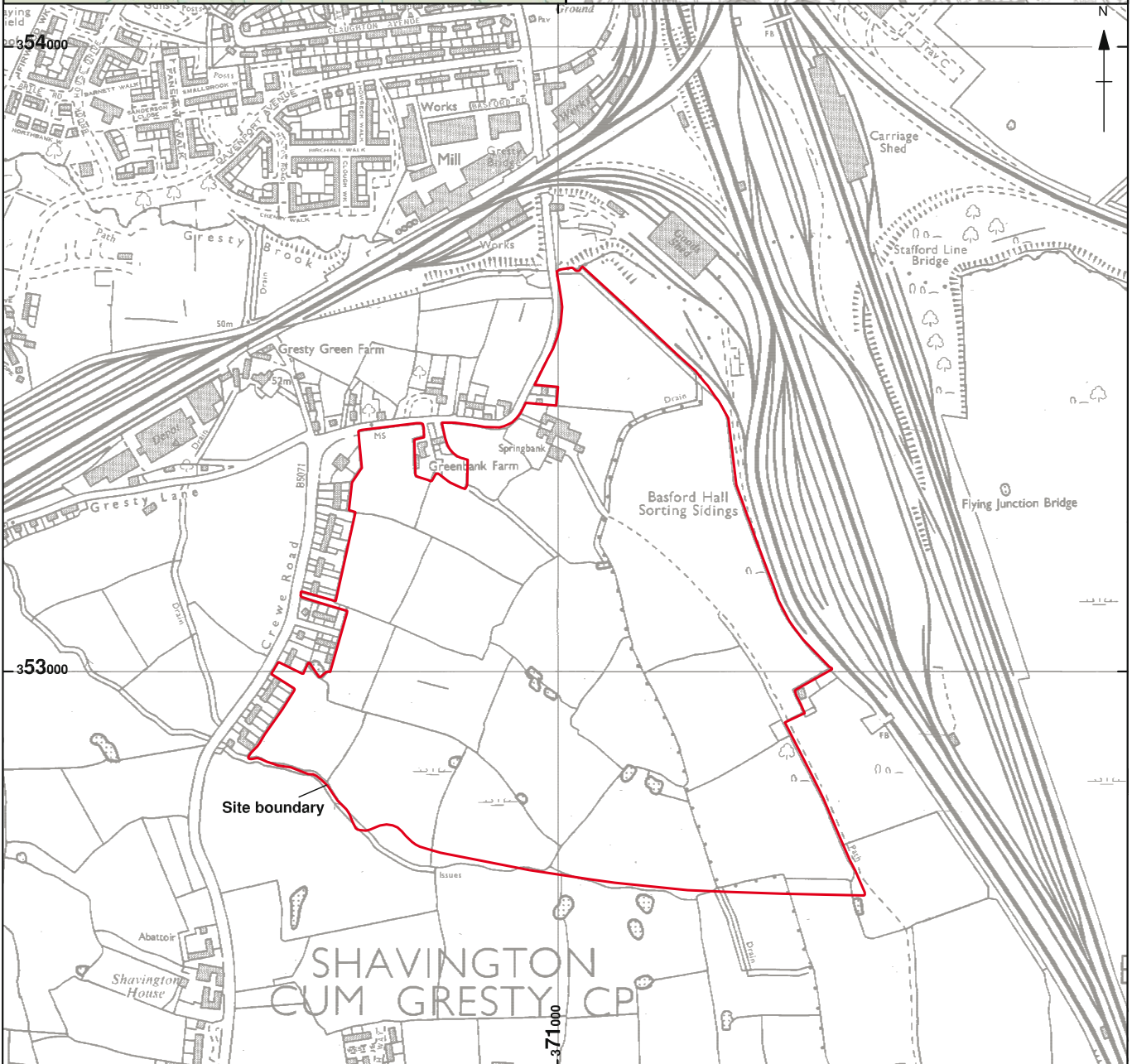
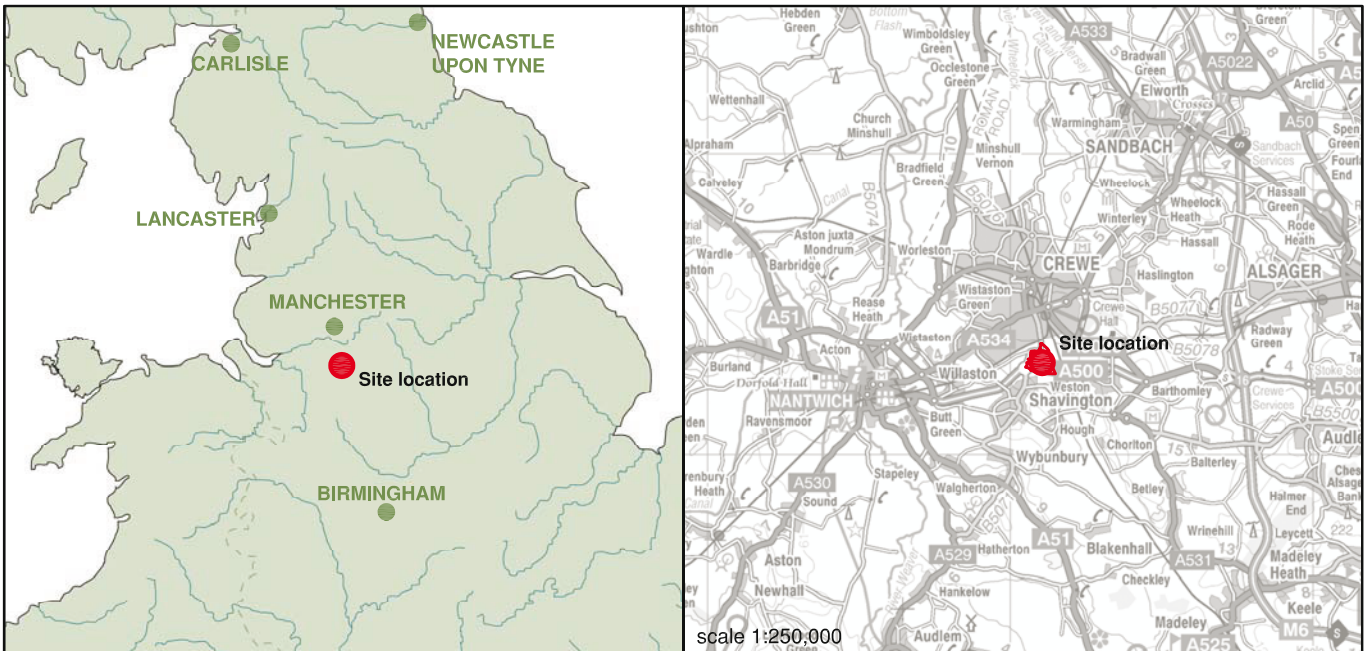

Based upon the Ordnance Survey mapping with the permission of the Controller of Her Majesty's Stationery Office ©Crown copyright. Unauthorised reproduction infringes Crown copyright and may lead to prosecution or civil proceedings. Oxford Archaeology Licence No. AL 100005569 (2008).

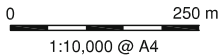

EM\*L10084\*AMS\*25-11-08

Figure 1: Site location

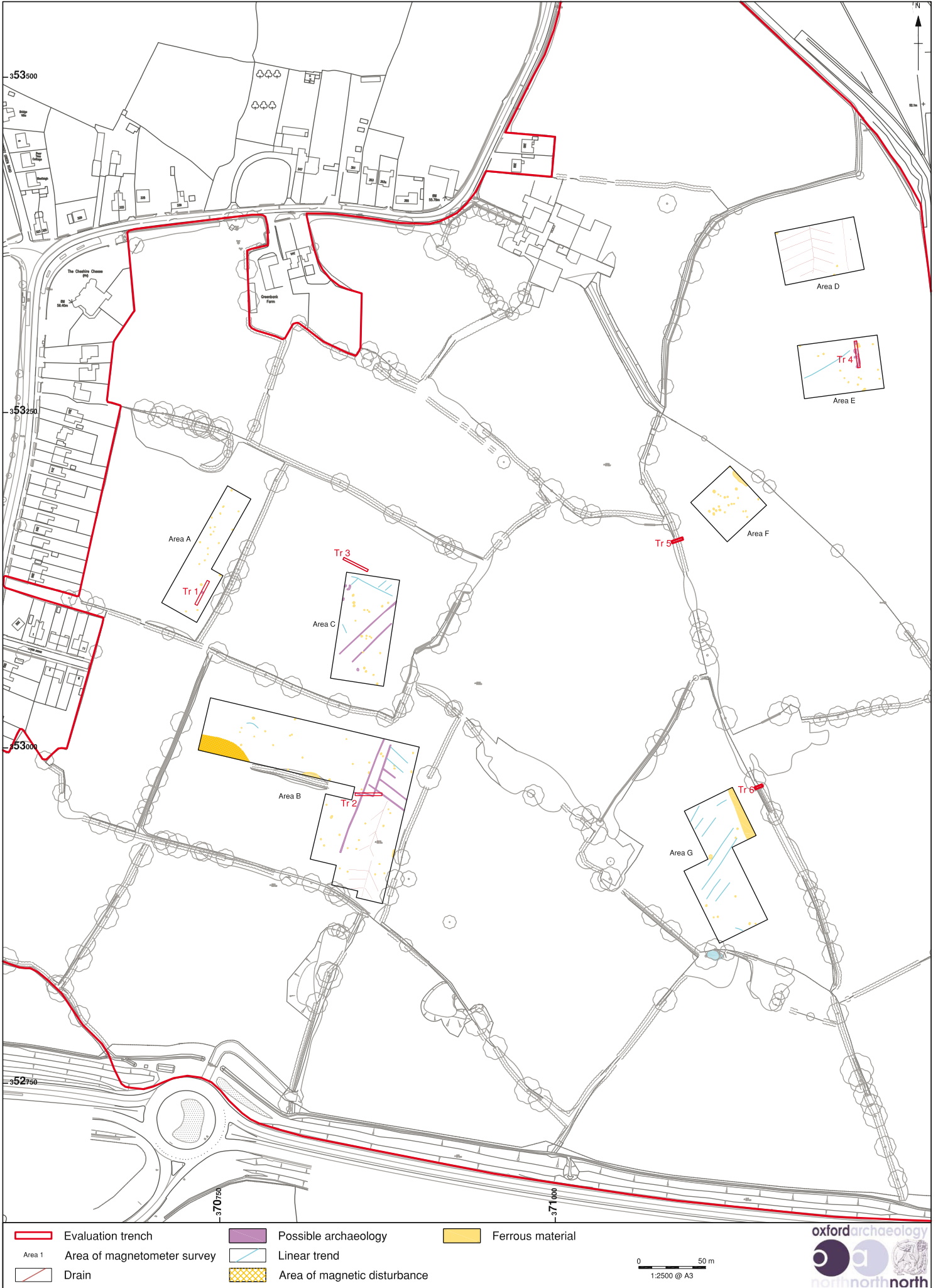
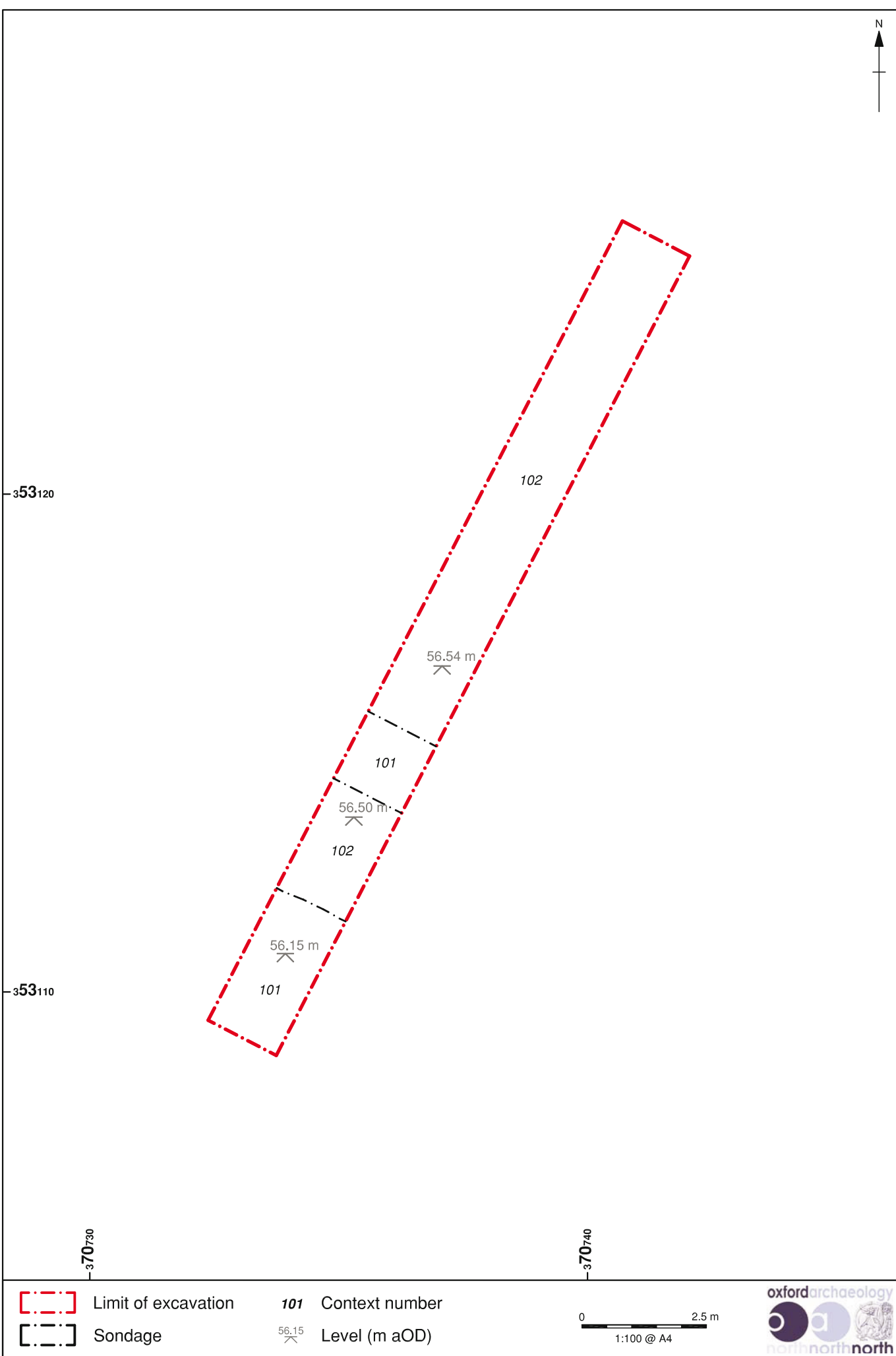
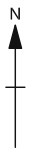

Figure 2: Location of evaluation trenches in relation to geophysical survey results



EM\*L10084\*AMS\*01-12-08

Limit of excavation  
 Sondage

**101** Context number  
 <sup>56.15</sup> Level (m aOD)

0 2.5 m  
1:100 @ A4



Figure 3: Detailed plan of Trench 1

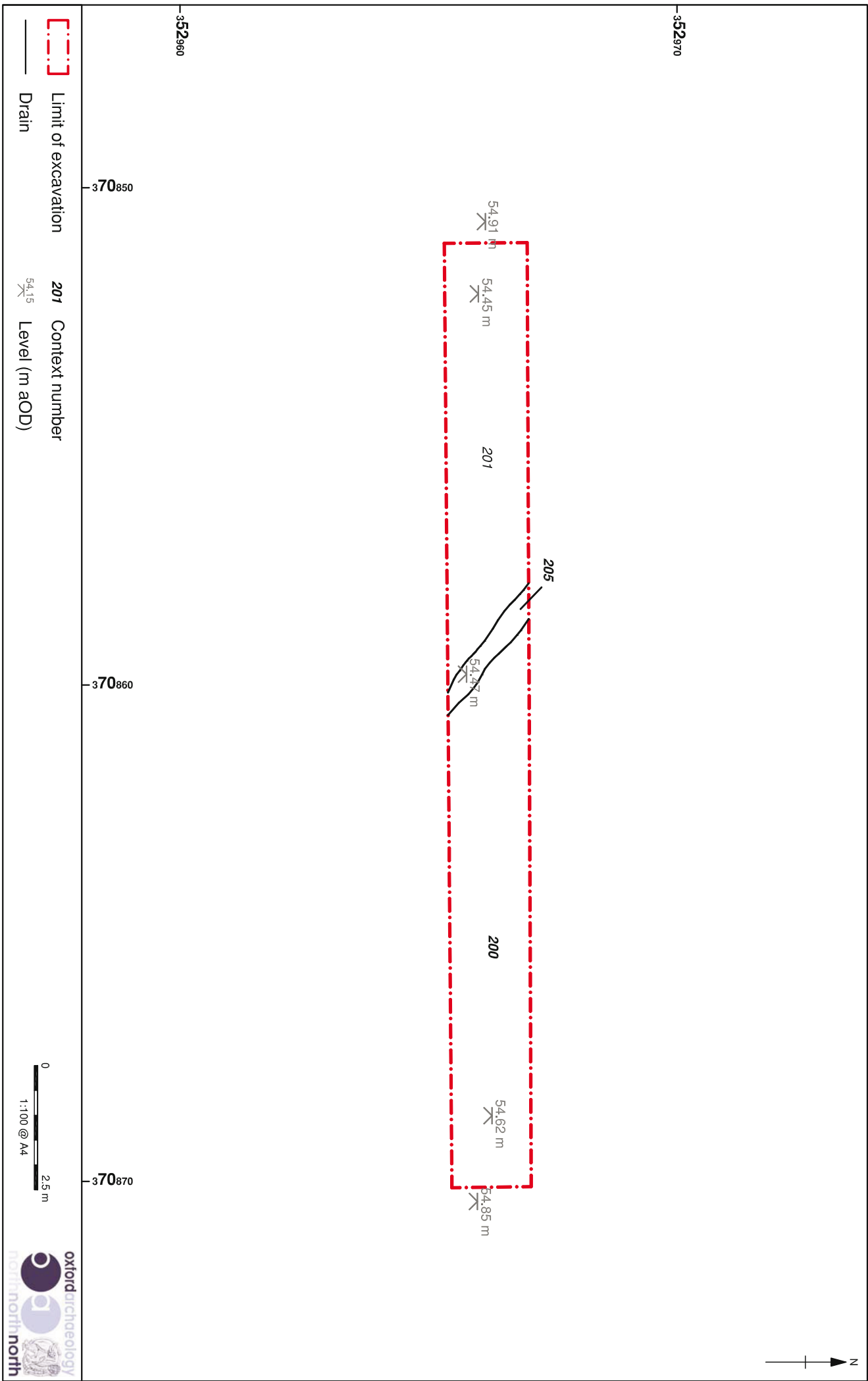
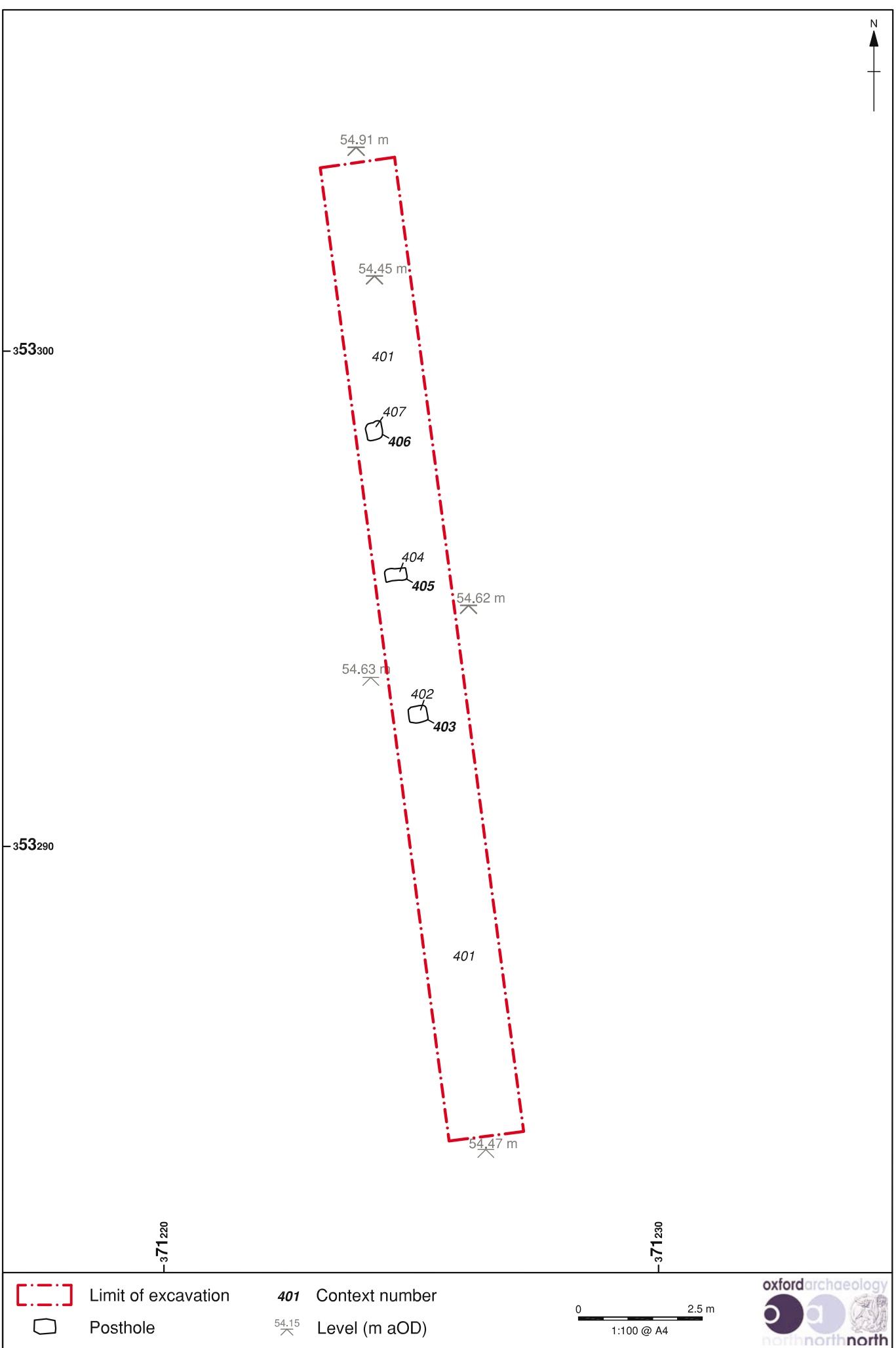
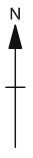

Figure 4: Detailed plan of Trench 2





EM\*L10084\*AMS\*02-12-08

- Limit of excavation
- Posthole

- 401** Context number
- <sup>54.15</sup> Level (m aOD)

0 2.5 m  
1:100 @ A4



Figure 5: Detailed plan of Trench 4

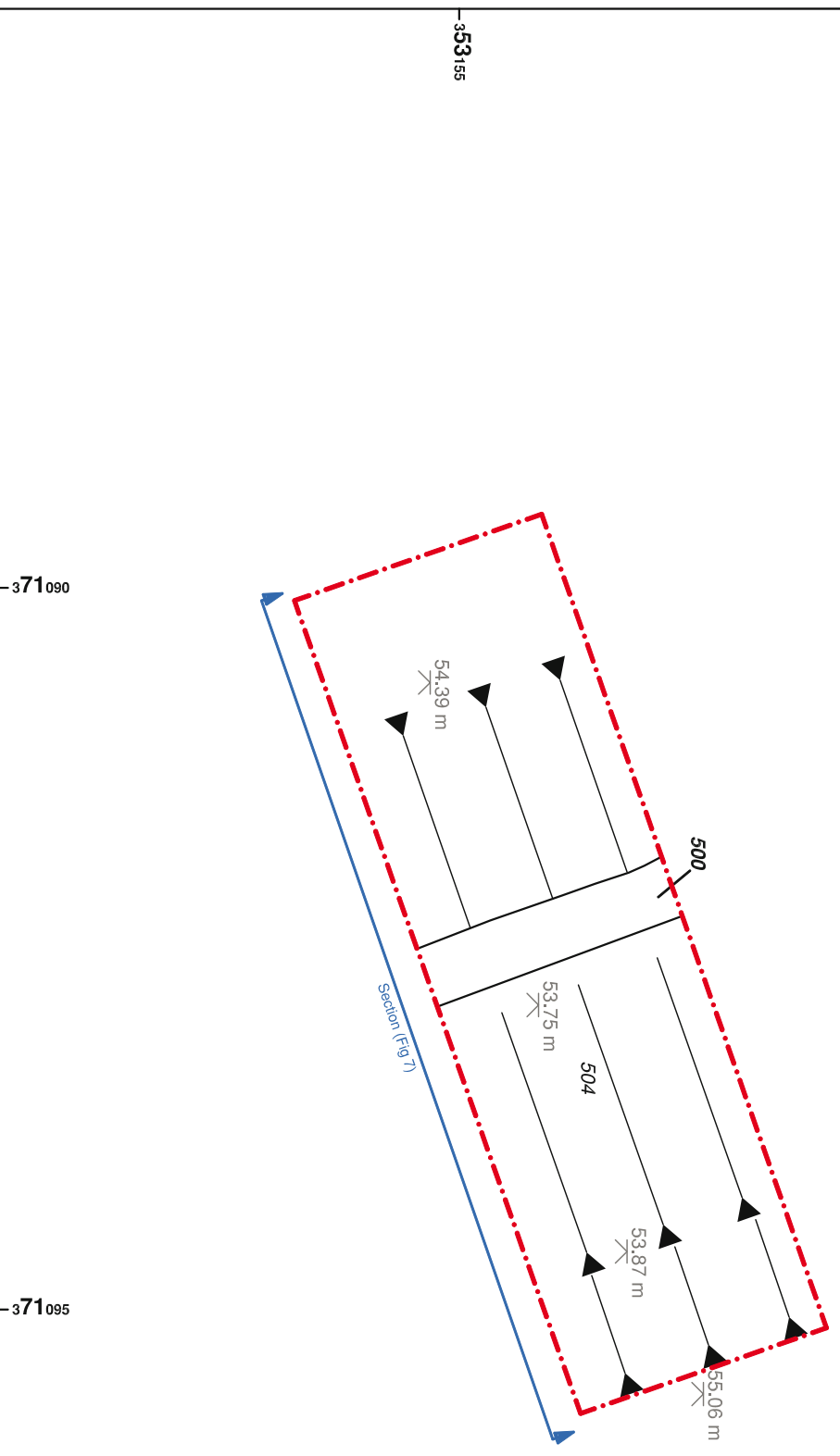
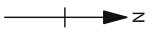

-  Limit of excavation
-  Ditch
- 500** Context number
-  53.75 Level (m aOD)

Figure 6: Detailed plan of Trench 5



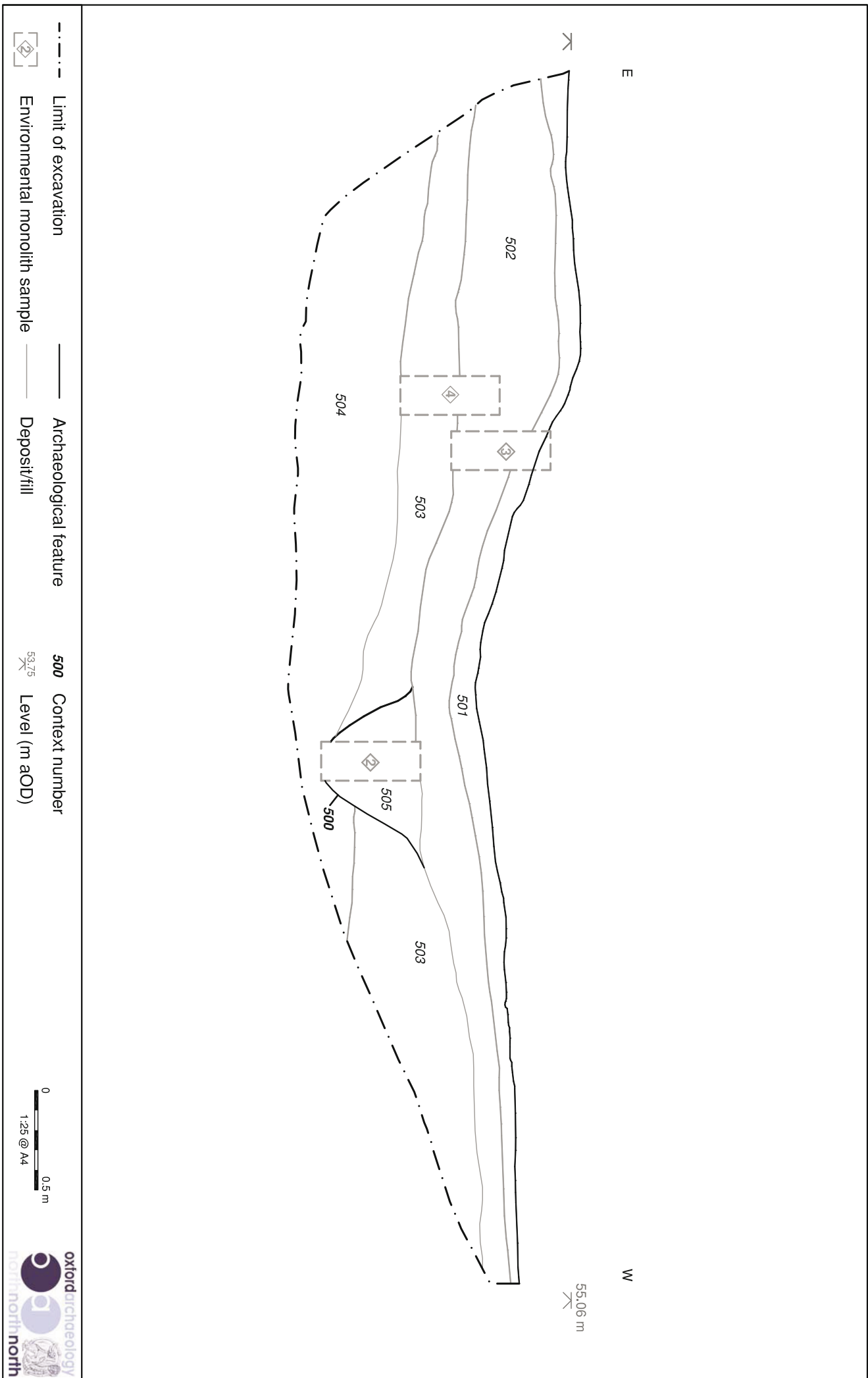

Figure 7: North-facing section through Trench 5

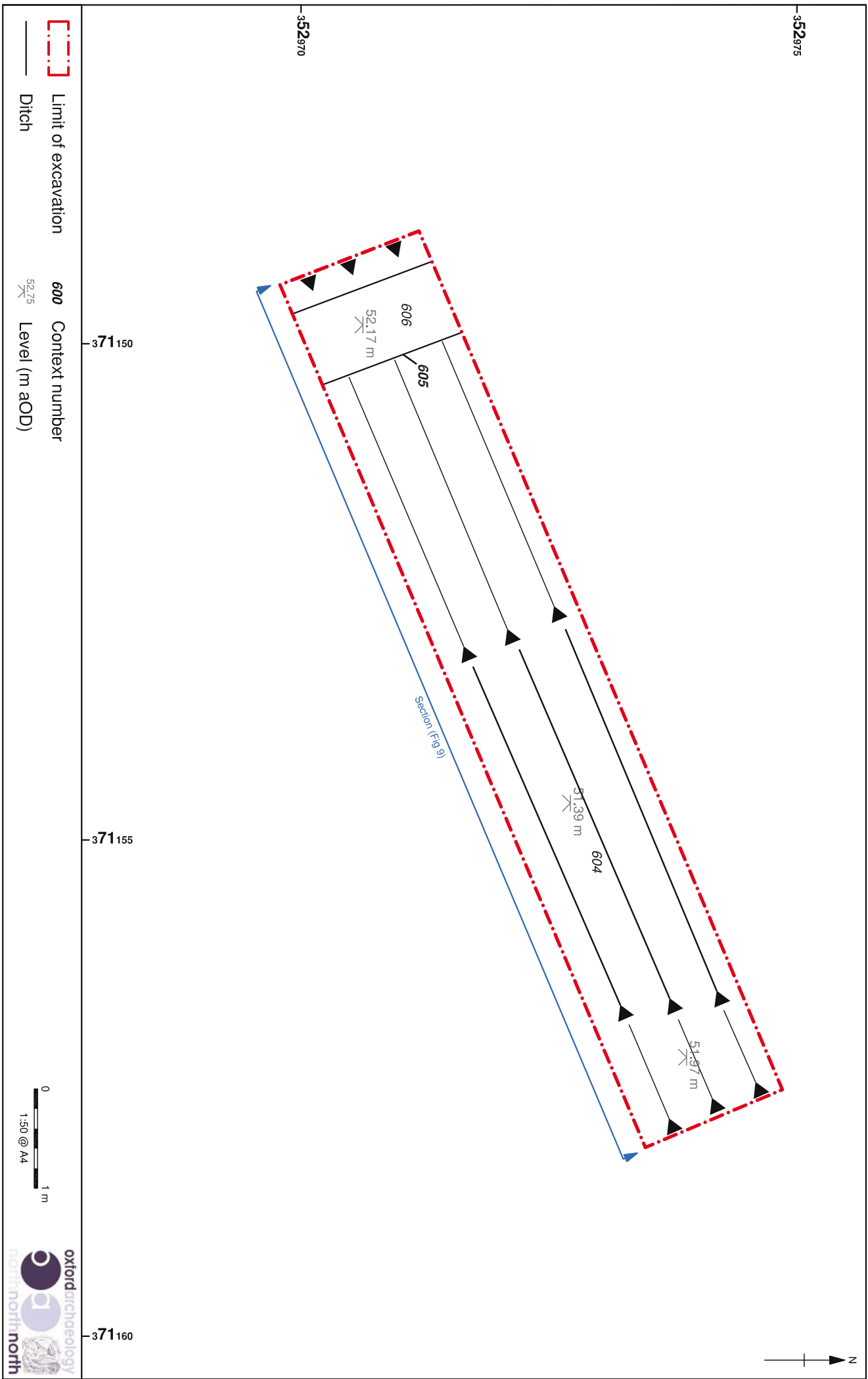
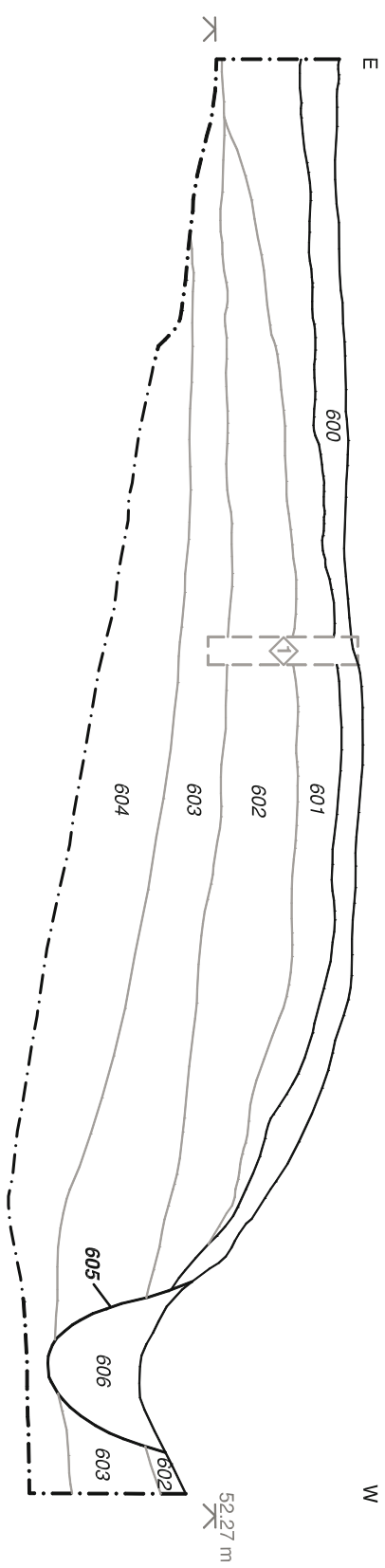







Figure 8: Detailed plan of Trench 6



-  Limit of excavation
-  Archaeological feature
-  Context number
-  Environmental monolith sample
-  Deposit/fill
-  Level (m aOD)

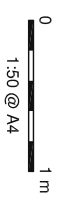

Figure 9: North-facing section through Trench 6